



UNIVERSITI
MALAYSIA
KELANTAN



CRI 2021
CARNIVAL OF RESEARCH AND INNOVATION
VIRTUAL INTERNATIONAL EDITION

e-PROCEEDING

CARNIVAL OF
RESEARCH & INNOVATION
(CRI 2021)
VIRTUAL INTERNATIONAL EDITION

In conjunction with



INTELLIGENT 2021
POLITEKNIK KOTA BHARU

I N T E R N A T I O N A L
VIRTUAL INNOVATION CHALLENGE
(INTELLIGENT2021)

&



CREATIVE INNOVATION CARNIVAL
(CIC) 2021

20 – 21 SEPTEMBER 2021
UNIVERSITI MALAYSIA KELANTAN, MALAYSIA

CHIEF EDITOR: NUR HAFEZAH HUSSEIN

The background of the entire page is a light gray circuit board pattern with various nodes and connecting lines. At the bottom of the page, there is a more detailed and colorful circuit diagram featuring purple, red, orange, and black components.

e-PROCEEDING

CARNIVAL OF

RESEARCH & INNOVATION

(CRI 2021)

VIRTUAL INTERNATIONAL EDITION



CRI 2021

CARNIVAL OF RESEARCH AND INNOVATION
VIRTUAL INTERNATIONAL EDITION

e-PROCEEDING

CARNIVAL OF
RESEARCH & INNOVATION
(CRI 2021)
VIRTUAL INTERNATIONAL EDITION

In conjunction with



INTELLIGENT 2021
POLITEKNIK KOTA BHARU

I N T E R N A T I O N A L
VIRTUAL INNOVATION CHALLENGE
(INTELLIGENT2021)

&



CREATIVE INNOVATION CARNIVAL
(CIC) 2021

© Research Management Innovation Centre, 2021

All right reserved. No part of this publication may be reproduced, stored in a retrieval system or transmitted in any form or any means, electronics, mechanical, photocopying, recording or otherwise, without prior permission, in writing, from the Research Management Innovation Centre, Deputy Vice Chancellor (Research & Innovation) Office, Universiti Malaysia Kelantan.

eISBN

978-967-2912-89-7

E-PROCEEDING OF CARNIVAL RESEARCH & INNOVATION (CRI2021)
VIRTUAL INTERNATIONAL EDITION

DESIGNER

Muhammad Najibul Muthie bin Che Ya'acob

CHIEF EDITOR

Nur Hafezah binti Hussein

EDITORS

Tenh Hock Kuan
Anuar bin Mohd Yusof
Mohammad Syukran bin Kamal Ruzzaman
Liyana binti Ahmad Afip
Nor Hazwani Munirah binti Lateh
Noor Izma binti Ab. Ghani
Nik Azida binti Abd Ghani
Wanly a/p Eh Keon
Nor Ashikin binti Mazlan
Nor Abidah binti Abdul Hamid
Tan Tse Guan

PUBLISHED BY

Research Management Innovation Centre (RMIC)
Deputy Vice Chancellor (Research & Innovation) Office,
Universiti Malaysia Kelantan,
16300, Bachok
Kelantan, Malaysia.

ORGANISED BY

Intellectual Property and Commercialisation Division
Research Management and Innovation Centre
Universiti Malaysia Kelantan

CO-ORGANISED BY

Faculty of
Creative Technology and Heritage

Faculty of
Language Studies and Human Development

POLITEKNIK
MALAYSIA
KOTA BHARU
Politeknik Kota Bharu, Malaysia

SUPPORTED BY

NATIONAL
STEM
ASSOCIATION
National STEM Association

TABLE OF CONTENTS

FOREWORD (BY THE VICE CHANCELLOR UNIVERSITI MALAYSIA KELANTAN	i
FOREWORD BY THE SENIOR DIRECTOR OF RESEARCH MANAGEMENT AND INNOVATION CENTRE, UNIVERSITI MALAYSIA KELANTAN	ii
FOREWORD BY THE DIRECTOR OF POLITEKNIK KOTA BHARU	iii
PREFACE BY CHIEF EDITOR	iv
ORGANIZING COMMITTEE	v
PART 1: SCIENCE & TECHNOLOGY	1
1 QN-OptiCal: A ROBUST CALCULATOR USING QUASI-NEWTON APPROACH FOR SOLVING MATHEMATICAL EQUATION	2
<i>Azfi Zaidi Mohammad Sofi, Sarizam Mamat, Nurul Akmar Che Zaudin, Nor Hakimin Abdullah, An'amt Mohamed Noor, Andi Hermawan, Abdul Hafidz Bin Yusoff, Sharizal Ahmad Sobri, Teo Pao Ter, Mohd Asrul Hery Bin Ibrahim, Khairul Nizar Syazwan, Hasyiya Karimah Adli, Arlina Ali, Muhammad Iqbal Ahmad, Mohamad Bashree Abu Bakar, Hafiz Mohd Hanafi, Khirulnizam Rahman & Nur Muizz Mohamed</i>	
2 THE 3D-BES	4
<i>Jamaliah Mohamad Sopi, Haryati Binti Ismail, & Nor Asma Binti Mamat</i>	
3 MEASUREMENT OF MILITARY COMBAT READINESS USING INTANGIBLE HUMAN DIMENSION FACTORS	6
<i>S. Inderjit, Hasan Al-Banna Mohamed, Abdul Rahman Abdul Razak Shaik, Safar Yaacob, Ummul Fahri Abdul Rauf, Jessica Ong Hai Liaw, Siti Najwa Zainuddin, Kwong Fook Wen, & Wong Wai Loong</i>	
4 SMART 3-WHEEL BIKE "EMPOWER DISABLED ENTREPRENEURS WITH TECHNOLOGY"	9
<i>Nurnaddia Nordin & Nurhaiza Nordin</i>	
5 PUBLIC MOBILITY MONITORING USING COMPUTER VISION AND GIS FOR MEASURING PANDEMIC SOCIAL DISTANCING IN EFFECTIVE AND SCALABLE MANNER	11
<i>Arham Muchtar Achmad Bahar & Wani Sofia Udin</i>	
6 BOOKTABLELA APPLICATION	13
<i>Navanitha Moorthy & K.S. Savita</i>	
7 SMART FERTILIZATION MANAGEMENT FOR OIL PALM TREE BASED ON IoT AND DEEP LEARNING	15
<i>Shaparas Daliman, Nur Ain Najwa Mohd Adib, Nazahatul Anis Amaludin, Noor Janatun Naim Jemali, Aweng Eh Rak, & Nordiana Abd Aziz</i>	
8 DEVELOPMENT OF INTEGRATED SCHEDULED WASTE MANAGEMENT SYSTEM FOR EDUCATIONAL SECTOR	17
<i>Norhidayu Noruddin, Ahmad Rasdan Ismail, Wan Azlee Wan Abdullah, Noor Syuhadah Subki, Siti Suhaila Mohd Nawawi, Mohd Khalid Ab Kadir @ Musa, Asma Salsabila Che Shaffie, & Mohamad Fazli Muhamad @ Che Abas</i>	
9 ISLAMIC HFitTracker: ISLAMIC HEALTH AND FITNESS TRACKER MOBILE APPLICATION FOR HEALTHY LIFESTYLES	18
<i>Mohd Fadil Mohd Yusof, Siti Salina Saidin, Nurul Hafizah Mohd Yasin, Siti Fatimah Ab. Ghaffar, & Nur Farihin & Abd Hadi Khan</i>	
10 A MULTI-PLATFORM AND LOW-COST NETWORK ATTACHED STORAGE FOR IOT APPLICATIONS	20
<i>Nurul Azma Zakaria, Zaheera Zainal Abidin, & Muhammad Iqbal Mohamad Zaimi</i>	

11	TECHNOLOGY IMPROVEMENT OF MINI SMART ARTIFICIAL INCUBATOR SYSTEM (SMART FIN-Tech) FOR FISH EGG	22
	<i>Suniza Anis Mohamad Sukri, Zulhisyam Abdul Kari@Abdullah, Hasnita Che Harun, Zuharlida Tuan Harith, & Mohd Fareezman Zamzuri</i>	
12	LOCKER SAFETY ALARM WITH BLYNK NOTIFICATION	24
	<i>Mohamed Faris Farhan bin Mohamed Rohi, & Zainuddin bin Omar</i>	
13	ZoN- ELECTRONIC SEMICONDUCTOR DEVICES	26
	<i>Arlina Binti Ali, Hidayani Binti Jaafar, Teo Pao Ter, Sarizam Binti Mamat, Norfadhilah Binti Ibrahim, Mohamad Najmi Bin Masri, Mohamad Bashree Bin Abu Bakar, An'Amt Bin Mohamed Noor, & Azfi Zaidi Bin Mohammad Sofi</i>	
14	VEHICLE ALERT SYSTEM	29
	<i>Ts. Mahayudin B. Saad, & Muhammad Danish Bin Syujahuddin Ganeson</i>	
15	IoT SOLAR REFRIGERATOR	33
	<i>Nur Sahira binti Ilias, Nur Filzah binti Mohd Fauzey, & Muhamad Tarmizie bin Ismail</i>	
16	WIRELESS HUMANOID ROBOT USING MICROCONTROLLER "ESP32" VIA BLYNK	35
	<i>Mohd Faizal bin Mustapha, Muhammad Arif bin Zainudi, & Wan Muhammad Afnan bin Wan Azli</i>	
17	SMART HOME AUTOMATION USING BLYNK	38
	<i>Muhammad Amir Syafiq bin Kamalruzzaman & Rosmaria binti Ariffin</i>	
18	IoT-BASED NON-INVASIVE BLOOD GLUCOSE MONITORING SYSTEM	40
	<i>Lim Shau, Ts. Dr. Siti Zuraidah Ibrahim, Ts. Dr. Ku Nurul Fazira Ku Azir, & Assoc. Prof. Dr. Ruzelita Ngadiran</i>	
19	RISK MITIGATION FOR SOFTWARE ANTI-AGEING DURING ANALYSIS OF CHANGES IN SOFTWARE MAINTENANCE	42
	<i>Noraini Che Pa , Thamaratul Izzah Binti Azman, Yusmadi Yah Jusoh, & Rozi Nor Haizan Nor</i>	
20	HUMAN ELEPHANT CONFLICT RECORD (HECoR) APP	44
	<i>Hazizi Husain, Kamarul Ariffin Kambali@Hambali, & Norashikin Fauzi</i>	
21	INTELLIGENT SPECTACLE FOR BLIND PERSON	46
	<i>Anuar Bin Mohamed Kassim, Muhammad Herman Bin Jamaluddin, Arman Hadi Bin Azahar, Mohd Rusdy Bin Yaacob, Sivarao A/L Subramonian, Albert Feisal @ Muhd Feisal Bin Ismail, Md Nazri Bin Othman, Muhammad Fahmi Bin Miskon, Ahmad Zaki Bin Shukor, Muhammad Mustaqiim Bin Roslan, Sahrul Bin Sahak, Nurul Nadia Binti Ayob, Muhammad As Shakirin Bin Abdul Aziz, & Awangku Khairul Ridzwan Bin Awangku Jaya</i>	
22	IoT BASED INTELLIGENT FIRE ALARM SYSTEM (I-FAST)	49
	<i>Anuar Bin Mohamed Kassim, Muhammad Mustaqiim Bin Roslan, Muhammad As Shakirin Bin Abdul Aziz, Muhammad Muslim Bin Mohd Rashidin, Muhamad Afiq Shahmi Bin Shamsul Izran¹, Sahrul Bin Sahak, Muhammad Malek Faizal Bin Mohammad Zaini, & Awangku Khairul Ridzwan Bin Awangku Jaya</i>	
23	SIMPLE COIN BANK USING ESP32	52
	<i>Noraida binti Yusoff, Hirni binti Rashid, Ajmal Danish bin Mohd Zemri, & Muhamad Akmal Aiman bin Mohd Azlan</i>	
24	IoT-BASED DOOR ACCESS CONTROL USING FACE RECOGNITION	54
	<i>Muhammad Afiq Bin Aznan, Ts. Dr. Siti Zuraidah Ibrahim, Ts. Dr. Ku Nurul Fazira Ku Azir, & Assoc. Prof. Dr. Ruzelita Ngadiran</i>	
25	LOW-COST AUTOMATIC CAT FEEDER	56
	<i>Nawi bin Berahim, Ahmad Irfan bin Kamaruddin, & Muhammad Afiq bin Na Amran</i>	
26	REGENERATIVE BRAKING SYSTEM FOR ELECTRIC VEHICLES	58
	<i>Mohammad Muktafi Ali Khan, Mohammad Muqtada Ali Khan, Hafzan</i>	

	<i>Eva Manosr, Elvaene James, Zaitul Zahira Binti Ghali @ Ghazali, & Sarizam bin Mamat</i>	
27	HEALTH EDUCATION MODULE (HEM) FOR THE PREVENTION OF RESPIRATORY ILLNESSES DURING HAJJ AND UMRAH <i>Mohammed Dauda Goni , Aisha Abubakar Baaba, & Ibrahim Abdul Azeez Okene</i>	61
28	TOWARDS AQUACULTURE PRECISION FARMING: IoT BIG DATA ANALYTICS USING MACHINE LEARNING <i>Khalifa Chekima & Brahim Chekima</i>	63
29	IoT SMART GUIDANCE PARKING SEARCH SYSTEM <i>Iszaidy bin Ismail, Nur Farhan Kahar, Ruzelita Ngadiran, & Mohamad Hanif Md Saad</i>	66
30	EARTHCARE APPS DEVICE <i>Nur Sajida binti Peduka, Zakiyah binti Taharim, Nur Izzah Amalia binti Hashim, Nur Bashiratul Khalidah binti Ismail Hisyam, Hazyati binti Hashim, & Fadhilahanim Aryani binti Abdullah</i>	68
31	APC-BUS: AUTOMATED PASSENGER COUNTING FOR INTELLIGENT BUS TRANSPORTATION SYSTEM <i>Aimi Salihah Abdul Nasir, Muhammad Rizal Farhan Shaik Osman, Muhammad Izuan Fahmi Romli, & Marni Azira Markom</i>	70
32	SMART INTERNET-OF-MEDICAL WEARABLE WATCH FOR EARLIER SYMPTOMS DETECTION, MONITORING AND TRACKING OF COVID-19 PATIENTS <i>Naimah Yaakob, Nik Adilah Hanin Zahri, Siti Hajar Bt Abdul Rahman, Riza Nur Arissha Bt Mohd Sabri, Devendran A/L Ramesparan, & Siti Nur Aisyah Bt Azara'ai, Mahathir Almashor</i>	72
33	VISION BASED SMART GRIPPER FOR MATERIAL HANDLING USING INTERNET OF THINGS <i>Hasimah Ali, Muhammad Irfan Zainur, Tan Yin Suan, & Mohamed Elshaikh</i>	74
34	CUSTOMIZED RAINFALL COLLECTOR FOR ISOTOPE ANALYSIS (²H, ¹⁸O, TRITIUM) <i>Roslanzairi Mostapa, Kamarudin Samuding, Mohammad Muqtada Ali Khan, Zakiyah Ainul Kamal, Hafzan Eva Manosor, Nor Shahida Binti Shafiee @ Ismail, & Aweng A/L Eh Rak</i>	76
35	SUPRIMA S5 <i>Mohd.Zulkafli Bin Mohamed, Tengku Azmie Bin Raja Hassan, Muhamad Shah Rul Bin Kamaruddin, Ahmad Suhaimi Bin Arshad, & Wan Amiruddin Bin Wan Mustapha</i>	78
36	SCIENTIFIC WRITING PAPER MANAGEMENT INNOVATION "I-REVIEW" <i>Hasanah Binti Safein @ Shafie, Ira Fazlin Bin Mohd Fauzi, Muhammad Daniel Nafis Bin Ahmad, Muhammad Yahya Bin Mat Rashid, & Wan Mohamad Fikri Bin Wan Shaharuddin</i>	80
37	HUMAN INTELLIGENCE PERFORMANCE PREDICTION BASED ON AI METHODS <i>Raja Suzana Raja Kasim, Ghous Bakhsh Narejo, Zulazli Hashim, Nurul Afiqah Zulazli, & Wan Nor Munirah Ariffin</i>	82
38	ARTIFICIAL INTELLIGENCE SYSTEM AND METHOD FOR SUSTAINABLE SOCIAL FINANCE DATA PREDICTION <i>Raja Suzana Raja Kasim, Ghous Bakhsh Narejo, Zulazli Hashim, Nurul Afiqah Zulazli, & Wan Nor Munirah Ariffin</i>	85
39	COMPACT RECIRCULATING AQUACULTURE SYSTEM (CORALS): ASIAN CLAM SAVIOUR <i>Zharif Ramli, Aweng Eh Rak, & Lee Seong Wei</i>	88
40	RIZBRUNANA: ADVANCES IN HIGH---FIBRE BISCUIT USING BROWN RICE AND BANANA PEEL <i>Nurul Hafizah Mohd Yasin, Derweanna Bah Simpong, Nur Farihin Abd Hadi Khan, & Mazne Ibrahim</i>	90

41	TERMICIDE: ONE DROP SOLUTION TO REPEL HOUSEHOLD PEST TERMITES <i>Suganthi Appalasamy, Nivaarani Arumugam, Alia Diyana Mohamed Hassim, Boon Jia Geng, & Jayaraj Vijaya Kumaran</i>	92
42	SPATIAL PREDICTION FOR AMBIENT PARTICULATE POLLUTION USING SPATAP MODEL <i>Siti Hajar Ya'acob, Siti Aisyah Nawawi, Noor Syuhadah Subki, Norrimi Rosaida Awang, Shaparas Daliman, & Muhammad Ikram A. Wahab</i>	94
43	DESIGN DEVELOPMENT OF WASTE COOKING OIL SMART FILTRATION BOX <i>Asriana Ibrahim, Rafiq Hilmi Alias, Mohd Hakim Naquuddin Abdul Kadir, Mohd Hafidzal Mohd Hanafi, & Nurul Hanim Razak</i>	96
44	ASTAX-FEED <i>Zuharlida Tuan Harith, Suniza Sukri, Nik Nur Azwanida Zakaria, Fatin Nursabriena Mohd Sabir, & Fatin Syuhada Remlee</i>	98
45	PINE-COOKIES <i>Ho Pei Zheng, Zuharlida Tuan Harith, & Nik Nur Azwanida Zakaria</i>	100
46	LA PANCA: THE FURNITURE FOR THE BOTTOM BILLION <i>Azli Abdullah, Nik Nurul Hana Hanafi, Siti Aisyah Muhammad, Najah Md Alwi, Nor Hafizah Anuar, Nuzul Haqimi Muhammad, Mhd Hafiz Karami Mhd Zain, Muhammad Rizal Khairuddin, Juliza Mohamad, & Yasmin Mohd Faudzi</i>	102
47	SONATA: MOBILISED ARCHITECTONIC STREET FURNITURE WITH MULTI-TRANSFORMATION <i>Siti Aisyah Muhammad, Nik Nurul Hana Nik Hanafi, Juliza Mohamad, Najah Md Alwi, & Nor Hafizah Anuar</i>	104
48	GINOC: EDIBLE FOOD DYE <i>Shamsul Muhamad & Saliza Anida Salleh</i>	106
49	THE INVENTION OF FISH FRY MOBILE, AUTOMATIC COUNTER (FRYMAC) USING ARDUINO UNO <i>Nur Aina Lyana Mohamad Ali, Nazrin Nazari, Norhaida Musri, & Nik Muhammad Farhan Nik Mohd Sani</i>	108
50	GUAJAVA – A NUTRITIONAL PINK GUAVA POMACE POWDER <i>Khomaizon Abdul Kadir Pahirulzaman & Fazilawati Shaari, Nurhanan Abdul Rahman</i>	110
51	PRECISE FERTILIZATION WITH DRONE-BASED TECHNOLOGY <i>Muhammad Nurfaiz Abd. Kharim, Aimrun Wayak, Abdul Rashid Mohamed Shariff, Ahmad Fikri Abdullah</i>	112
52	BIODEGRADTION OF WASTE COOKING OIL, ORGANIC MATERIAL AND PLA-FILAMEN MIXTURE <i>Mohd Hafidzal Mohd Hanafi, Anis Ainaa Omar, Ainul Syakirah Md Saffie, Nurul Hanim Haji Razak, & Asriana Ibrahim</i>	114
53	VSOL- INNOVATIVE METHOD TO DETERMINE ULTRA TRACE LEVELS OF PESTICIDES IN FRUITS <i>Krishna Veni Veloo</i>	116
54	OLEOPHILIC POLYMER WASTE – OIL SOLIDIFIER (OPWOS) FOR USED COOKING OIL (UCO) <i>Nurul Hanim Razak, Mohd Hafidzal Mohd Hanafi, Asriana Ibrahim, Nurul Afwa Ab Razak, & Norlina Mohamad Norani</i>	117
55	BOTANICAL REPELLENTS AGAINST SNAIL (ACHATINA FULICA) <i>Tengku Halimatun Sa'adiyah Binti T Abu Bakar, Aionon Najihah Binti Abd Rahman, Jeffry Anak Tasek, Tengku Halimatun Sa'adiyah Binti T Abu Bakar, Suhana Binti Zakaria, Maryana Binti Mohamad Nor, Norhafizah Md Zin, & Raja Ili Airina Raja Khalif</i>	120
56	MULBERRY LEAVES CHIPS <i>Tengku Halimatun Sa'adiyah Binti T Abu Bakar, Mohamad Syahid Farhan Bin Mohd Zaki, Nurul Hasanah Binti Ibrahim, Hanis Syazwani Binti Haron, Mohamad Nabil Bin Razali, Maryana Mohamad Nor, Suhana Zakaria &</i>	123

	<i>Siti Nuurul Huda Binti Mohammad Azmin</i>	
57	SMART CHAMBER FOR PRE-ACCLIMATIZED TISSUE CULTURE BANANA PLANTLETS	125
	<i>Suhana Zakaria, Tengku Halimatun Saa'diah T Abu Bakar, Maryana Mohamad Nor, Fatimah Kayat, Raja Ili Airina Raja Khalif, & Muhammad Irfan Hakim Azmi</i>	
58	SCREENING AND TRIAGE CUBICLE (S.A.T CUBE) FOR COVID-19	127
	<i>Mhd Hafiz Karami Mhd Zain, Wan Azlina Wan Ismail, Najah Md Alwi, Norwina Mohd Nawawi, Wan Pauzi Wan Ibrahim, Azirawati Ismail, & Mohd Zurairie Mohd Zubir</i>	
59	PREMIUM TMR: ALL-IN-ONE FEED FOR LAMBS	129
	<i>Nor Dini Rusli, Mira Panadi, Khairiyah Mat, Hasnita Che Harun, Mohd Mahmud, Syed Muhammad Al-Amsyar Syed Abd. Kadir, Mohamad Khairi Mohd Zainol, & Zamzahaila Mohd Zin</i>	
60	FUELLING FUTURE TREASURE: COMMUNITY-BASED E-WASTE RECYCLING MODEL	131
	<i>Marieanne Christie Leong, Aweng Eh Rak, Suganthi Appalasamy, Amal Najihah Muhamad Nor, Nur Aqilah Azmi, Jayaraj Vijaya Kumaran, Wong Hie Ling, Muhammad Firdaus Abdul Karim, & Robin Sebolino</i>	
61	DEVELOPMENT OF STRAW MUSHROOM (VOLVARIELLA VOLVACEA) FLOUR AND ITSAPPLICATION IN BAKING PRODUCT	134
	<i>Saw Wei Xian & Noor Hafizoh Binti Saidan</i>	
62	A CASE STUDY – IMPACT OF COVID-19 ON LIVESTOCK FARMERS IN KELANTAN	137
	<i>Nur Syuhada Sazali, Mohammad Mijanur Rahman, Khairiyah Mat, Nor Dini binti Rosli, & Raja Ili Airina binti Raja Khalif</i>	
63	IRFRAM WASTE TRAP	139
	<i>Muhammad Ramzi Bin Ramli, Muhammad Irfan Bin Asri, & Affidah Mardziah binti Mukhtar</i>	
64	PREGNAMIX; RECIPE FOR BREEDING IN RUMINANTS	142
	<i>Raja Ili Airina R.K, M S Nazhiifah Amiirah, Abu Bakar K.N., Mohamad Azlan, S.S., Z Suhana, Nor M. M, & T H S T Abu Bakar</i>	
65	HEALTH CHIPS	144
	<i>Puan Fadilah Hanim Aryani Binti Abdullah, Kasthuri A/P S Visvanathan, Kaushilia A/P Haridash, Keerthana A/P Kalangan, Kirtthana Makendran, Rajtheeban A/L Muthuraman, & Suganthi A/P Muniandy</i>	
66	IoT IRRIGATION MONITORING AND CONTROL SYSTEM	146
	<i>Aziz Mamat, Wan Muhammad Amirul Asyraf Bin Azhar, & Wan Siti Zulaikha Bt Wan Azhar</i>	
67	SUITABILITY OF VEGETATION INDICES METHOD IN DETERMINING THE COCONUT TREE STRESS	148
	<i>Faris Alias & Wani Sofia Udin</i>	
68	GREENTECH PEDUNCUBE MADE FROM CUCURBITA SPP., BANANA PEDUNCLE & BENINCASA HISPIDA	150
	<i>Mohamad Khairullah Bin Atan, Amni Balqis Bt Zurkurnai, & Nuraina Nafessa Bt Abdul Hakim</i>	
69	BAMBOO AS REINFORCEMENT IN CONCRETE	152
	<i>Tengku Suriati Binti Tengku Yusoff</i>	
70	A MATHEMATICAL MODEL DEVELOPED TO PREDICT RESIDENTIAL EXPOSURE TO PESTICIDE VAPOURS EMITTED FROM TREATED FIELDS	154
	<i>Wong Hie Ling, Shaparas Binti Daliman, Marieanne Christie Leong, Siti Hajar Binti Ya'acob, & Muhammad Firdaus Bin Abdul Karim</i>	
71	ECO-TROLLEY SHOPPING BAG	156
	<i>Nur Fatihah Binti Ramli, Shahirah Binti Aziz, & Siti Hawa Binti Kadir</i>	

72	SURFACE-ACTIVE AGENT OF NEWLY ISOLATED BACTERIUM, <i>Pseudomonas sp</i> DSB7 <i>Ainihayati Abdul Rahim, Nurazeerah binti Khamis, Noor Azlina Ibrahim, Khomaizon Abdul Kadir Pahirul Zaman</i>	158
73	UNDERGROUND WATER TREATMENT SYSTEM FOR PRIMARY SCHOOL USING ECO WATER MEDIA FILTRATION (ECO WMF) <i>Nik Nurul Anis Nik Yusoff, Wan Mohd Faizal Wan Ishak, Nik Raihan Nik Yusoff, Mohamad Najmi Masri, Nabihah Abdullah, & Shafini Mohd Shafie</i>	160
74	VCENDOL: RETORT PROCESS FOR READY-TO-DRINK (RTD) CENDOL <i>Syamsuriana Sidek, Tuan Muhammad Muiz T. Nordin, Yusrinadini Zahirah Md. Isa @ Yusuff, Nurul Azwa Mohamed Khadri, & Hazrina Hasbolah</i>	162
75	BIOMARKERS EXPRESSION AS A SUCCESSFUL TREATMENT EFFICACY INDICATOR IN POST TREATMENT MANAGEMENT INNOVATION OF MANNHEMIOSIS IN GOATS <i>Mohd Farhan Hanif Reduan, Jasni Sabri, Fathin Faahimaah Abdul Hamid, Nur Athirah Abd Manaf, Intan Noor Aina, & Faez Firdaus Jeese Abdullah</i>	164
76	KOMBU-FEED⁺ : INCORPORATION OF BLACK SOLDIER FLY LARVAE MEAL AND KOMBUCHA TEA AS FISH FEED REPLACEMENT AND FEED SUPPLEMENT TO AFRICAN CATFISH, <i>CLARIAS GARIEPINUS</i>. <i>Ruhil Hayati Hamdan, Tan Li Peng, Mohd Farhan Hanif Reduan, Nora Faten Afifah Mohamed, Ain Auzureen Mat Zin, Chan Jian Ern, & Ahmad Syazwan Samsuddin</i>	166
77	PHOSPHATE SOLUBILIZING BACTERIA FROM PADDY RHIZOSPHERE AS BIOFERTILIZER <i>Nik Fatin Qharanie Binti Nik Mohd Kamaruzaman & Ainihayati Binti Abdul Rahim</i>	168
78	SPINACH CRACKER: A NEW SNACK FOOD FOR EVERYONE <i>Leony Tham, Daphane Teo Wen Xin, & Nurhanan, A.R</i>	170
79	ProovyFeed: POULTRY FEED OF SUSTAINABLE PROTEIN SOURCES <i>Khairiyah Mat, Nor Dini Rusli, Hasnita binti Che Harun, Zulhisyam bin Abdul Kari, Mohammad Mijanur Rahman, Mohd bin Mahmud, Syed Muhammad Al-Amsyar, Lee Seong Wei, & Leony Tham Yew Seng</i>	172
80	ACTIVATED CARBON FROM FOXTAIL PALM FRUIT FOR REMOVAL OF METHYLENE BLUE, Cr(IV) AND METAMIFOP <i>Nik Raihan Nik Yusoff, Nisrina Nadia, Noor Syuhadah Subki, Rozidaini Mohd Ghazi, Asanah Radhi, Nik Nurul Anis, Musfiroh Jani, & Noor Janatun Naim, Marinah Muhammad</i>	174
81	BIOCIDE FOR SICK BUIDLING SYNDROME FUNGUS (BioC-F) <i>Muhamad Azahar Abas, Kamarul Ariffin Hambali, Muhammad Firdaus Abdul Karim, Lukman Ismail, Nor Hizami Hassin. Nurul Syazana Abdul Halim, Amal Najihah Muhamad Nor, Hamzah Hussin, & Hafizi Rosli</i>	176
82	SWEET POTATO AND BLACK BEAN PASTA <i>Nurhanan, AR & Nur Azhani Azzaharah, N</i>	178
83	A RAPID DIAGNOSTIC TECHNIQUE FOR DETECTION OF VIRAL DISEASES <i>Ruqayyah Ainul Bashirah, Nurulhuda Najihah Zainal Abidin, Nur 'Atikah Abdul Latif, Mariatulqabtiah Abdul Razak, & Kuo Pin Chuang</i>	180
84	INTEGRATED SOLAR-IoT MONITORING AND PREDICTIVE MAINTENANCE SYSTEMS FOR IRRIGATION (S-IoTP) <i>Hasyiya Karimah Adli, Khairul Nizar Syazwan Wan Salihin Wong, Muhammad Akmal Remli, & Ku Azmie Ku Husin</i>	182
85	SPATIAL FRAMEWORK OF ZERO COVID 19 OUTBREAK FOR SUSTAINABLE HEALTH IN KELANTAN <i>Amal Najihah Muhamad Nor, Rohazaini Muhammad Jamil, Hasifah Abdul Aziz, Muhamad Azahar Abas, Siti Aisyah Nawawi, Marieanne Christie Leong, Kamarul Ariffin Hambali, Nor Hizami Hassin, Muhammad Firdaus Abdul Karim, Aainaa Syazwani Mohamad Amir Hamzah, Wani Sofia Udin,</i>	184

Roniza Ismail, Nazahatul Anis Amaludin, Mohamad Faiz Mohd Amin, Norfadhilah Ibrahim, Abdul Hafidz Yusoff, Nur Hairunnisa Razaai, & Nur Hanisah Abdul Malek

- | | | |
|-----------|---|-----|
| 86 | SUPER PROTECTION GRPAHENE FACE MASK
<i>Thinakaran Narayanan & Kaushik Pal</i> | 186 |
| 87 | IComPBag
<i>Azura Sharena Yahaya, Siti Nor Farhanah Sh Nor Shahidin, & Mohd Fahmi Lukman</i> | 187 |
| 88 | MICROENCAPSULATED ASTAXANTHIN FACE SERUM
<i>Nik Nur Azwanida Binti Zakaria, Nurul Najwa Izzati Binti Mohd Zakuwan, & Zuharlida Tuan Harith</i> | 189 |
| 89 | TOMCAT TRAP
<i>Nik Azida binti Abd Ghani, Juli Suzlin binti Jalaluddin, Syed Zainal Abidin bin Syed Noor Wahid, Muhammad Azham Aizil bin Othman, Nurul Durrani binti Afandi, & Hanis Izzati binti Roslan</i> | 191 |
| 90 | INNOVATIVE TREATMENT MANAGEMENT OF NOTOEDRIC MANGE WITH A COMMERCIALGAMAT OIL PREPARATION IN CATS
<i>Siti Nur Amira binti Zambri, Jasni bin Sabri, Abd Rahman bin Aziz, Ibrahim Abdul-Azeez Okene</i> | 193 |
| 91 | ANTIBIOFILM PROPERTIES OF GRAPHENE OXIDE AGAINST STAPHYLOCOCCUS AUREUS ISOLATED FROM BOVINE MASTITIS
<i>Nor Fadhilah Kamaruzzaman, Liang Vivian, & Shamsaldeen Ibrahim Saeed</i> | 196 |
| 92 | ANTI-PSOPRIASIS COSB (Cathanranthus roseus extract, Olive oil, Shea butter & Beewax) OINTMENT
<i>Sujej Kumar Rajendren, Chooi Kah Loong, Abdul Rahman Bin Aziz, & Nor Fadillah Binti Kamaruzzaman</i> | 197 |
| 93 | AUTOMATED SCREENING AND CELLS COUNTING SYSTEM FOR LEUKAEMIA AND MALARIA
<i>Aimi Salihah Abdul Nasir & Thaqifah Ahmad Aris, Mohd Yusoff Mashor, & Zeehaida Binti Mohamed</i> | 199 |
| 94 | DETECTION AND ASSOCIATED RISK FACTORS ON GASTROINTESTINAL PROTOZOA IN OWNED CATS IN SELECTED DISTRICTS IN KELANTAN
<i>Nurshahirah Shahrulnizim, Tan Wan Loong, Intan Noor Aina, Basripuzi Nurul Hayyan</i> | 201 |
| 95 | MASSAGE BAR ADDED WITH WATERMELON SKIN EXTRACT & MINT (Cool-Lit Watermelon Massage Bar)
<i>Siti Nuurul Huda Mohammad Azmin & Nur Dini Dayana Zamzuri</i> | 203 |
| 96 | SMART OPTIMIZATION SYSTEM (SOS): OPTIMIZATION SYSTEM TRACKER OF BLOOD COLLECTION OPERATION DURING COVID 19
<i>Ts. Muhamad Hafiz Bin Masran, Ts. Dr. Wan nor Munirah Ariffin, Dr. Nor Azrita Mohd Amin, Nur Arif Azezan, YM Prof. Dr. Hjh Raja Suzana Raja Kasim, & Muhammad Suhaimi bin Zaini</i> | 205 |
| 97 | PARTICLE BOARD MADE FROM WASTE EXPANDED POLYSTYRENE (EPS)
<i>Andi Hermawan, Tuan Mohamad Firdaus bin Tuan Muhamad Adnan, Sharizal bin Ahmad Sobri, Nor Hakim bin Abdullah, & Mohd Hazim bin Mohamad Amini</i> | 207 |
| 98 | HIGH GRADE ALPHA CELLULOSE OF SESBANIA GRANDIFLORA
<i>Liew Jing Xian, Boon Jia Geng, Liew Jeng Young, & Suganthi Apalasy</i> | 209 |
| 99 | GREEN POROUS CERAMIC THERMAL INSULATOR (GreenPCTI) MADE FROM WOOD SAW DUST WASTE
<i>Pao Ter Teo, Afiqah Awang Kechik, Siti Koriah Zakaria, Nur Atikah Muhammad Tharmizi, Arlina Ali, Jia Geng Boon, Mardawani Mohamad, Mohamad Najmi Masri, Julie Juliewatty Mohamed, & Mustaffa Ali Azhar Taib</i> | 211 |

100	KELANTAN BAMBOO ACTIVATED CARBON: AN ECONOMICAL AND SUSTAINABLE INNOVATION FOR WASTEWATER TREATMENT BY ADSORPTION TECHNIQUE	213
	<i>Danial Shamzari bin Hashim, Liew Jeng Young, Boon Jia Geng, Ng Kooi Huat, & Sim Kheng Yuen</i>	
101	WASTE TO WEALTH; A NOVEL BIODEGRADABLE COMPOSITES FROM AGRICULTURE WASTE FOR DRUG DELIVERY	215
	<i>Nor Hakimin Abdullah, Nur Aiman Mohamad Senusi, Rathesh Kumaran A/L Ulaganathan, & Mohammad Aiman Hakim Bin Abdullah</i>	
102	REDUCING CORROSION ON STAINLESS STEEL PIPELINE VIA HYDROGEN INDUCE CRACKING	217
	<i>Associate Professor Dr. Mohamad Najmi Masri & Nur Adeeba Zakiah Che Yusoh Zaki</i>	
103	THE IMPROVEMENT OF MAMBONG CLAY PROPERTIES WITH CALCIUM CARBONATE ADDITION	219
	<i>Nurul Ainon Bakar, Siti Mariam Mat Nor, Noruzzaman Daud, Wan Nor Dini Wan Azli Jasmi, Muhammad Qusyairi Saari, Julie Juliewatty Mohamed, & Hasanah Safein@Shafie</i>	
104	K-NUFF BLOCK	222
	<i>Mardawani Mohamad, Mohamad Najmi Masri, Teo Pao Ter, Mohd Fadzhel Mohd Nasir, Abdul Hadi Hassan, Mohd Ali Amin, Azkhari Munif</i>	
105	INNOVATION OF HERBAL LIQUID BATH SOAP WITH ALOE VERA EXTRACT AND OLIVE OIL EXTRACT EFFORTS TO BRIGHTEN THE SKIN WITH VISCOSITY METHOD AND CHEMICAL COMPOUND EXPERIMENT	223
	<i>Dika Putra Wijaya, Milan Rosa Aprilia, & Daffa Dwi Nafisah</i>	
106	THE CONVERSION OF LDPE PLASTIC WASTE INTO FUEL	225
	<i>Mohammad Shamizi bin Sayuti, Muhammad Afiq Farhan bin Ab Aziz, & Affidah Mardziah binti Mukhtar</i>	
107	MECHANICAL PROPERTIES OF CELLULOSE NANO CRYSTAL/GRAPHENE NANO PLATELETS REINFORCED POLY(LACTIC) ACID BIOCOMPOSITES	228
	<i>Abu Bakar, M. B., Mustapha, N. I., Mazli, N. I., Rosdi, N. A. M., Mohd, S. H., & Mohamed, M.</i>	
108	EFFECT OF CELLULOSE NANO CRYSTAL AND GRAPHENE NANO PLATELETS ON THERMAL PROPERTIES OF UNSATURATED POLYESTER RESIN REINFORCED KENAF FIBRE BIOCOMPOSITES	230
	<i>Bakar, M. B. A, Rosdi, N. A. M., Mohd S. H., Mohamed, M., & Abdullah, N. H.</i>	
109	PHYSICAL PROPERTIES OF CELLULOSE NANOCRYSTAL (CNC) / GRAPHENE NANOPATELETS (GNP) HYBRID NANOFILLERS REINFORCED POLYLACTIC ACID BIOCOMPOSITES	232
	<i>Abu Bakar, M. B, Mazli, N. I., Mohd, S. H., Md Akil, H., & Rosdi, N. A. M</i>	
110	DEGRADATION OF METAMIFOP BY TiO₂/Al₂O₃/CNT, TiO₂/Al₂O₃/G AND Al₂O₃/G	234
	<i>Nik Raihan Nik Yusoff, Mahani Yusoff, Rozidaini Mohd Ghazi, Asanah Radhi, Nik Nurul Anis, Musfiroh Jani, Noor Janatun Naim, & Marinah Muhammad</i>	
111	FOOD PACKAGING BIOPLASTIC FILM FROM COCOA POD HUSK INCORPORATED WITH SUGARCANE BAGASSE	236
	<i>Siti Nuurul Huda Mohammad Azmin & Najah Aliah Mohd Hayat</i>	
112	SMART VIEW AND ANTIFUNGAL ENTO CABINET (SVAFEC)	237
	<i>Norashikin Fauzi, Noor Syuhadah Subki, Zaitul Zahira Ghali@Ghazali, & Musfiroh Jani</i>	
113	TWO RODS FISHING BAIT LAUNCHER	239
	<i>Mohd Hafidzal Mohd Hanafi, Muhammad Nur Ariffuddin Nuruddina, Fadhilah Shikh Anuar, Nurul Hilwa Mohd Zini, & Mohd Noor Asril Saadun</i>	

114	THE CEILING FAN CLEANER	241
	<i>Mohd Zaidi bin Mahmud & Zahidi Bin Hivadullah</i>	
115	PORTABLE ELECTRIC GENERATOR	243
	<i>Norlila binti Mohd Yusoff, Masarizan binti Mohamed, Syahmi Adib bin Nazri, & Muhammad Nur Aiman bin Mohd Zulkifli</i>	
116	BRIDGE TESTING APPARATUS (BRIDGTEST)	245
	<i>Noor Hazwani Binti Sapuan, Farha Binti Mohamed Yasin, Mohd Yusri Bin Yusop, & Zulkiflie Bin A Wahab</i>	
117	COCONUT FIBRE GRINDING MACHINE	247
	<i>Mariam Binti Abdul Aziz, Wan Muhammad Azim Bin Wan Makhzan, & Siti Nor Syamimi Binti Abd Razak</i>	
118	DEVELOPMENT OF REALTIME MONITORING SYSTEM FOR WELDING PARAMETER MONITORING (seeWeld)	250
	<i>Sarizam Mamat, Ahmad Zaki Amiruddin, Khairul Nizar Syazwan Wan Salihin Wong, Azfi Zaidi Mohammad Sofi@Aziz, Airel Jashimiey Arifin, Rose Ellyana Alifah Roslan</i>	
119	HANDS FREE HAND SANITIZER	251
	<i>Sheilani Binti Shaari & Nur Alia Izatey Binti Ismail</i>	
120	CNC MACHINE MOTION CONTROL TECHNIQUE FOR ISO 14649 DATA INTERFACE MODEL	253
	<i>Kamran Latif, Shafinaz Ismail, Muhammad Hazimi Hilmi Md Puzi, Hamdan Syakirin Md Amir, & Krisnan Kandhian</i>	
121	LANDSLIDE SUSCEPTIBILITY MAPPING USING THE GEOGRAPHIC INFORMATION SYSTEM (GIS) APPROACH	255
	<i>Rohazaini Muhammad Jamil, Noorzamzarina Sulaiman, Nursufiah Sulaiman, Siti Aisyah Nawawi, Amal Najihah Mohamad Nor, & Norfadhilah Ibrahim</i>	
122	SMART SOLAR GRASS CUTTER	257
	<i>Mohd Hisham Bin Makhtar, Wan Muhammad Marzudi Bin Wan Muhammad, Muhammad Rozidie Bin Sazali, Muhammad Amyrul Aizat Bin Mohd Asri, & Ahmad Fahmi Bin Mohamed</i>	
123	OBIA: MAPPING FOREST MADE EASY!	259
	<i>Noor Janatun Naim Jemali, Mohd Fariz Abd Rhani, Syafinie Majid, & Marinah Muhammad</i>	
124	MOBILE PRECAST STUMP AND FOOTING	261
	<i>Mohd Yuzha Bin Usoff, Hamidah Bt Zakaria, Mohd Hilmei Bin Abdul Azif, Izhah Bin Wahab @ Hassan Basari</i>	
125	COMPRESSIVE STRENGTH OF OIL PALM SHELL CONCRETE GRADE 30	263
	<i>Tengku Suriati Binti Tengku Yusoff</i>	
126	RTK GPS CONSISTENCY IN VERTICAL CONTROL WORK	266
	<i>Nor Azme Bin Nordin, Asiah Binti Abdul Satar, & Sulzakimin Hj Mohamed</i>	
127	SMART RECYCLE BIN SYSTEM(I-BIN)	269
	<i>Anuar Bin Mohamed Kassim, Muhammad Mustaqiim Bin Roslan, , Muhammad As Shakirin Bin Abdul Aziz, Muhammad Muslim Bin Mohd Rashidin, Muhamad Afiq Shahmi Bin Shamsul Izran, Sahrul Bin Sahak, Muhammad Malek Faizal Bin Mohammad Zaini, Awangku Khairul Ridzwan Bin Awangku Jaya</i>	
128	A STUDY ON RECYCLED TYRES AS AN ADDITIVE IN CONCRETE MIXTURE	273
	<i>Nor Abidah binti Abdul Hamid, Nur Ezzah binti Mohd Sidik, Siti Farah binti Mohd Sidik</i>	
129	SELF-ENERGY GENERATION BUILDING: PORTABLE E-STORAGE DEVELOPED VIA RENEWABLE ENERGY (RE)	275
	<i>Salmiah Binti Aziz, Siti Nuratirah Binti Che Mohd Nasir, Mohammed Fadzli Bin Maharimi, Neha R Jacob</i>	
130	WASTE TO WEALTH: CASSAVA PEEL STARCH	278

	BIOFLOCCULANT	
	<i>Norzila Othman & Syazwani Mohd Asharuddin</i>	
131	DESIGN OF DOORPAGE FOR CARRYING AND INSTALLING DOORS	280
	<i>Mohd Fadly Bin Abdullah, Wan Nur Aqilah Binti Wan Nawang, & Mohd Sobri Bin Hassan</i>	
	PART 2: SOCIAL SCIENCE	283
132	VIRTUAL EARLY MATHEMATICS LEARNING KIT FOR ADDRESSING THE AMBIGUITY OF MATHEMATICAL PROCEDURAL SKILLS AND TERMINOLOGIES	284
	<i>Prof. Madya Dr. Anida Sarudin, Dr. Husna Faredza Mohamed Redzwan, Dr. Wan Mazlini Othman, Prof. Madya Dr. Zulkifli Osman, Prof. Madya Raja Noor Farah Azura Raja Ma'mur Shah, Prof. Madya Dr. Intan Safinas Mohd Ariff Albakri, Dr. Siti Rahaimah Ali, & Muhammad Nazrin Abu Bakar</i>	
133	AR OF BRITISH PILLBOX AS A MEDIUM IN EDUCATION THROUGH THE TOURISM SECTOR FOR YOUNG GENERATIONS	287
	<i>Nur Athmar Binti Hashim, Dr. Tengku Fauzan Tengku Anuar, Dr Siti Aisyah Muhammad, & Nur Farhana Bt Shuhaimi</i>	
134	PROGRAMMING TRAINER KIDS (ProKiDs)	291
	<i>Chung Boon Chuan, Nik Rahaya binti Nik Ishak, Nur Filzah Binti Mohd Fauzey</i>	
135	PROGRAMMING EDUCATION CARDS GAME (PECgame)	294
	<i>Chung Boon Chuan, Melissa Khor Suan Chin, & Udom A/L Ewon</i>	
136	SMART NOTES	297
	<i>Nik Noorafieda Binti Wan Azraen</i>	
137	STACK THE ENGLISH GAMES (STEN.G) INNOVATION FOR TEACHING AND LEARNING	299
	<i>Melissa Khor Suan Chin, Chung Boon Chuan, Siti Martini Binti Mustapha</i>	
138	SEISMIC REFLECTION INTERPRETATION USING AR APPLICATION TO ENHANCE UNDERGRADUATE STUDENT'S UNDERSTANDING	303
	<i>Noorzamzarina binti Sulaiman, Nursufiah bte Sulaiman, Rohazaini binti Muhammad Jamil, Wani Sofia binti Udin, Nor Shahida binti Shafiee @ Ismail, Fazrul Razman bin Sulaiman</i>	
139	TALKING SNAKES & LADDERS	305
	<i>Marianti binti Mohd Suhaimi</i>	
140	MOBILE APPLICATION DEVELOPMENT TO TEACH ENGLISH PROFICIENCY COURSES	307
	<i>Nazatul Syima Mohd Nasir, Nor Hazwani Munirah Lateh, Khairul Hisyam Baharuddin, Amaal Fadhlini Mohamed</i>	
141	IoT RESCUE BUTTON	308
	<i>Nazratulhuda Hashim, Wan Majdah Ton Mamat, & Zetty Rohaiza Mohd Ishak @ Sahak</i>	
142	LEGO MODEL LAYOUT PLAN TOOL KIT EXPLORATION FOR STUDIO-BASED LEARNING	311
	<i>J. Azri, N. A. H. Hamizah, H. Ramly, L. H. I. Ismi, M. K. Rizal, M. M Fadzli</i>	
143	Account4U	314
	<i>Noorul Azwin Md Nasir, Siti Afiqah Zainuddin, Nadzirah Mohd Said, Noorshella Che Nawwi, Tahirah Abdullah, Wan Farha Wan Zulkifli</i>	
144	THE LEMBAH SIREH-KB CITY WEB APP: PROTOTYPE FOR SITE ANALYSIS IN FINAL YEAR ARCHITECTURE STUDIO TEACHING	316
	<i>Najah Md Alwi, Mhd Hafiz Karami Mhd Zain, Muhammad Mujibur Rahman Bin Ahmad Safuan, Liew Ho Yen, Ariff Asyraf Bin Ab Rahman, Muhammad Azeem Bin Mohd Rizal, Nurul Fatimah Binti Said, Nur 'Izzatul Zaharah Binti Mohd Rosli</i>	
145	Jen-HyPe: ENHANCING LEARNERS' ENGAGEMENT VIA HYBRID TEACHING AND LEARNING PEDAGOGY	317

	<i>Mohamad Najmi Masri, Mardawani Mohamad, Ain Zulaikha Zuhairi, & Teo Pao Ter</i>	
146	Mar-ProD: PROJECT-BASED LEARNING APPROACH VIA INNOVATIVE PROJECT DESIGN	319
	<i>Mardawani Mohamad, Noor Fazliani Shoparwe, Rosmawani Mohammad, Teo Pao Ter, Mohamad Najmi Masri, & Wan Hasnidah Wan Osman</i>	
147	CREATING EXCITEMENT IN LEARNING THROUGH TIKTOK APPLICATIONS	322
	<i>Normaizatul Akma Saidi, Naziatul Aziah Mohd Radzi, & Mazne Ibrahim</i>	
148	PKB-JOBLINK	324
	<i>Aslamaitulakma Mohamad, Norhidayah Mohamad Yusop, & Roslina Idris</i>	
149	THE SIMULATION IN VIRTUAL LEARNING FOR PRACTICAL COURSES: A PROPOSED IDEA	326
	<i>Mazne Ibrahim, Naziatul Aziah Mohd Radzi, & Normaizatul Akma Saidi</i>	
150	GAMIAPP: USING GAMES IN WHATSAPP TO INCREASE PUPILS' ENGAGEMENT IN ENGLISH PDPR	328
	<i>Siti Hajar Akma Mohd Rawi & Mhd Hafiz Karami Mhd Zain</i>	
151	APPLICATION OF THE KIRKPATRICK MODEL: EFFECTIVENESS IN ACCOUNTING COURSE	330
	<i>Normaizatul Akma Saidi, Noraida Saidi, Derweanna Bah Simpong, Nur Azimah Othman, Hazztyati Hashim, Nadzirah Mohd Said, Wan Farha Wan Zulkiffli</i>	
152	GET2GETHER: THE WEB-APP THAT CAN WORKS WITHOUT THE INTERNET	332
	<i>Azlin Sharina Abdul Latef, Nuzul Haqimi Muhammad, Hana Yazmeen Hapiz, Sarah Wahida Hasbullah, Mohd Zaimmudin Mohd Zain</i>	
153	DEVELOPING WEBSITE FOR TEACHING DIGITAL TOOLS IN ARCHITECTURE AND CREATIVETECHNOLOGY PROGRAMS	335
	<i>Nuzul Haqimi Muhammad, Azlin Sharina Abdul Latef, Noorul Huda Mohd Razali, Hana Yazmeen Hapiz, Yuhanis Ibrahim</i>	
154	PERFORMING VISUAL INTERPRETATION AND ANALYSIS IN VIRTUAL SERIAL VISION (VSV) USING SATELLITE IMAGERY AS NAVIGATION TOOLS	337
	<i>Nor Hamizah Abdul Hamid, Muhamad Ezran Zainal Abdullah, Nurul Izzati Othmani, Syahidah Amni Mohamed, Ramly Hassan, Wan Azlina Wan Ismail, Wan Saiful Nizam Wan Mohamad, Noorliyana Ramlee, Nurfadilah Saadul Kurzi, Yeo Lee Bak, Mohd Azri Mohd Jain Noordin, Ruwaidah Borhan</i>	
155	THE ENGAGEMENT OF CLASSIC INTERACTIVE DOLLS IN ESL ONLINE CLASS FOR PDPR	339
	<i>Amaal Fadhlini Mohamed, Nazatul Syima Mohd Nasir, Ariezal Afzan Hassan, & Wan Suzanna Aafanii Adeeba Wan Hassan</i>	
156	AN INNOVATION OF AUTOMATIC SOLAR TRACKER USING ARDUINO	342
	<i>Salwati Binti Mohamed@Awang, Nik Nor hishamuddin Bin Nik Mustapha, Ahmad Baihaqi Bin Mohd Hatim</i>	
157	SRAV TRAINER KIT	344
	<i>Syed Arifin Bin Engku Sulong, Nor Juliha Binti Said, Roslinda Binti Sidek</i>	
158	SMART SPRING ABSORBER REPLACEMENT [SSAR-01]	346
	<i>Mohd Azri bin Abdul Ghani, Muhd Naqib Bin Mohd Rezali, Muhd Irfan Akif Bin Mohd Radzi, Muhd Syafiq Bin Mohd Afandi</i>	
159	DUE 10012 COURSE OVERVIEW ANIMATION VIDEO	348
	<i>Wan Rahayah Rahimi Wan Ramli</i>	
160	PORTABLE PROGRAMMABLE LOGIC CONTROLLER TRAINER WITH MODULES FOR TRAINING	350
	<i>Nurul Aemyza Binti Che Fauzi, Roslinda binti Ismail, Nurul Fatini Bt Abdul Pattah, Mohamad Adli Bin Mohamed Nor, Mphd Adli Bin Zaki, Mohd Hafiq Bin Che Sayuti</i>	

161	CONDUCT OF GRADATION TEST IN DETERMINATION OF SOIL PARTICLE SIZE DISTRIBUTION USING VIDEO	352
	<i>Norli Binti Ismail & Rus Ayunita Binti Jusoh</i>	
162	JAMBOARD IN FINANCIAL MANAGEMENT: ENGAGED AND ENHANCED STUDENT'S PERFORMANCE	354
	<i>Ruzanifah Kosnin, Siti Salina Saidin, Suchi Hassan, Ahmad Fahme Mohd Ali, & Naziatul Aziah Mohd Radzi</i>	
163	FAULT FINDER DEVICE FOR SINGLE PHASE INDUCTION MOTOR (FFIM)	356
	<i>Azani bin Mat Ali, Mohd Rizuhan Bin Jaafar, & Jafni bin Othman</i>	
164	FS MADE EASY TEMPLATE	358
	<i>Noraida Saidi & Dr. Normaizatul Akma Saidi</i>	
165	MAGIC PIZZA FLOUR	360
	<i>Hanirah Binti Mohamad Nur, Hasniza Binti Tawyer, Mohd Ramadan Bin Mohd Khalid</i>	
166	MULTIMETER KIT`S	362
	<i>Khetijah binti Samat, Julia Izura binti Jopely, Nor 'Aziah binti Abdullah</i>	
167	MOBILE EDUCATIONAL APPLICATION: SMART CASH FLOW	365
	<i>Nur Afifah Binti Ahmad & Norzaiti Aktar Binti Mohamed</i>	
168	"POGRAM MINI PROJECT" GOOGLE SITES AS AN INNOVATION IN STUDENTS'S PROGRAM IMPLEMENTATION	368
	<i>Nurliyana Husna Binti Ramli & Mohd Faizal B Ismail</i>	
169	INSTASPACE MODULE	370
	<i>Fariha Diyana Binti Awang Ali, Muhammad Anwar Bin Mohd Kamal, Mirza Madihah Bt Zainal, Jayemogen a/I Shanmugam</i>	
170	A SHORT VIDEO ON JOB INTERVIEW	372
	<i>Noor Asmaa' binti Hussin, Kamilah binti Zainuddin, Nik Nur Fathiha bin Nik Din</i>	
171	CLAP SWITCH	374
	<i>Noor Azim Hakimie B Azli, Nurliyana Husna Binti Ramli, Mohd Faizal B Ismail</i>	
172	SMART DUSTBIN	376
	<i>Muhammad Nabil Najmi Bin Mohd Razali, Muhammad Arif Farhan Bin Hanipa, Nurliyana Husna Binti Ramli, & Nazihah Bt Che Rozan</i>	
173	STEM INTEGRATED LEARNING: MECHANICAL HANDS	378
	<i>Anisah Binti Jawawi, Wan Siti Rodziah Binti Mohd Nasir, Norainin Binti Ahamed, Muhammad Hazmi Bin Mustafa Bakri, Muhammad Rafiq Amir Bin Rahimin, Muhamad Atiqullah Bin Abdullah, & Muhammad Hafizuddin Bin Amran</i>	
174	DEAR SIR: SMART INTERACTIVE RESEARCH TOOL FOR STUDENTS	381
	<i>Nadia Hanum Binti Amiruddin, Norzianis Binti Rezali @ Abdul Sukor, Sulaiman Bin Mohammed Khalid, Siti Daleela Binti Mohd Wahid, Norraidah Binti Abu Hasan, & Ahmad Sapuan Bin Hasan</i>	
175	READ-A-LOT!: READEA	383
	<i>Fatin Sabrina Abdul Sukor , Norhidayah Binti Md Yusof, Nor Fazura Md Zulkifle, Nur Baiti Binti Ismail Shauki</i>	
176	AN INNOVATION ON ENHANCING ORAL PRESENTATION SKILLS THROUGH SELF-ASSESSMENT OF VIDEO RECORDING AND ORAL PRESENTATION TEMPLATE	385
	<i>Roslan bin Mamat, Yuzaimi binti Yazid, & W. Farhana binti W. Halim</i>	
177	#SOFTWARETHESES A FASTER WAY TO FIND RESEARCH GAPS AND COLLECT CONTENTS FOR CHAPTER 1,2,3,4,5	387
	<i>Ahmad Humaizi Hilmi & Ahmad Zaim Hilmi</i>	
178	YOU ARE JACK! - ENHANCING ENGLISH LITERACY THROUGH FAIRYTALE ADVENTURE	389
	<i>Syed Muhammad Adam Syed Najib, Farah Diyana Wan Iskandar Shah, Ummi Rumaisyah Masdino, Muhammad Shafiq Muhammad Nor,</i>	

	Muhammad Al-Ameen Amir Fauwaz, Ai'syah Abd Mutalib, Nurshahirah Azman, Ann Sofee Razali, Mirza Madihah Zainal, & Hazeeq Hazwan Azman	
179	ELECTRICAL ENGINEERING MATHEMATICS APP Muhammad Shahrizal Bin Shahrimy, Wan Izyani Binti Wan Jusoh, Rozaimah Binti Mustapa	391
180	SMART POWER LOCK KIT Ahmad Zhafran Bin Yusof & Wan Amiruddin Bin Wan Mustapha	393
181	IPS GAME: LEARN BASIC SOLAT THROUGH 3D GAME Mohamad Fakhri bin Fadzil, Nadia Akma Ahmad Zaki, Nor Masharah Husain, & Nor Zuhaidah Mohamed Zain	395
182	TEACHING AND LEARNING AID OF AUTOMATIC WINDSHIELD WIPER SYSTEM Wan Husni Zaim Bin Wan Muhamad , Mohamad Bin Hitam@Yahaya, & Ahmad Suhaimi Bin Arshad	397
183	'I-MATH 4U' Ainor Izmira binti Maimun@Mahmood, Hanisah binti Yusof, & Suzilaeli binti Mohd Sarman	399
184	TUTORZONE COST & MANAGEMENT ACCOUNTING 2 Noraihan binti Mamat Zambi, Noor Hanim binti Ismail, & Nor Lailihuda binti Ismail	402
185	i-KIAMAT PROTOTYPE: INFORMATION OF 'KIAMAT' TERMINOLOGY IN AL-QURAN Khairul Asyraf Mohd Nathir & Siti Nur Baiin Che Harun	405
186	MOBILE APPLICATION OF AR SURAH AD-DHUHA Aslina Saad & Muhammad Aqmal Firdaus b. Azlin	408
187	MOBILE ROBOT DEVICE TRAINER (MoRDeT) Suriati Ramle, Ct Salwaniee Bahayahkhi, Wee Siuw Sia	410
188	HUBEE ROBLOX ENGLISH LANGUAGE LEARNING: GLOBAL DIGITAL CHANGE-MAKER IN THE MAKING Nor Hanim Mustafa & Nur Hafezah Hussein	412
189	GAMIFY LEARNING FOR SUSTAINABLE SCIENCE STUDENTS THROUGH ESCAPE GAME BASED Nurul Syazana Abdul Halim, Nor Shahirul Umirah Idris, Muhamad Azahar Abas, Norrimi Rosaida Awang	416
190	TAX KIT: I'M A JUNIOR TAX AGENT Muhammad Zamrin Bin Maliki & Wan Azilah Binti Wan Yunus	418
191	SOCIAL INNOVATOR TALENT DEVELOPMENT INNOVATIVE FRAMEWORK: CERTIFIED SOCIAL ENTREPRENEURIAL INNOVATOR PROGRAM Wan Mohd Nazdrol bin Wan Mohd Nasir, Siti Aishah Attaullah, Nik Zulkarnaen Khidzir, Jayaraj Vijaya Kumaran, Nik Maheran Nik Muhammad, & Mohamad Izharrullail Azmi	420
192	SPEAKING SQUARES Siti Martini binti Mustapha, Rosilawati binti Muhamad Ramli, Zarina binti Hashim, Noor Hafiza binti Zainuddin, & Rodey Hamza bin Hamzah	422
193	THE "RADIO OF TAFSIR QURAN": UNDERSTANDING TAFSIR QURAN THROUGH INTERACTIVE GADGET Shamsul Kamal bin Abdullah @Mohd Khir, Roslan bin Yahya, Alinawati bt Ab Aziz@Kamarulzaman, Rasidah bt Md Nor, & Mohd Zohdi bin Said	424
194	PARCEL STORAGE BOX Afiqah Natrah Binti Shahrudin, Nur Aliya Nadhirah Binti Shamsunaha, Siti Aisyah Binti Zulkifli, Wan Nur Anis Hidayu Binti Wan Zailani, Aida Ashyurani Binti Mohd Razully	426
195	A MOTIVATION VIDEO: YOU CAN DO IT! A SHORT VIDEO IN DEVELOPING TECHNICAL STUDENTS TO LOVE ENGLISH LANGUAGE Che' Fadhilah Binti Che' Lah & Shuzura binti Yusof	428

196	C.G.G. INTEGRATED E-TOOLS FOR COLLABORATIVE WRITING AND FEEDBACK IN TEACHING ACADEMIC ENGLISH WRITING	430
	<i>Nur Hafezah Hussein</i>	
197	STEM FORENSIC KIT: SCIENCE FORENSIC LEARNING AID	432
	<i>Hazeeq Hazwan Azman, Muhamad Faqih Damarulan, Muhammad Aqil Noor Azali, Maegala Nallapan Maniyam, Norazah Mohammad Nawawi, Nadzirah Abu Samah, Khairil Bariyyah Hassan, Hasnur Hidayah Kamaruddin, Rahayu Md Khalid, Norhisyam Mat Sout, Hasdianty Abdullah, Marini Ibrahim, Nur Akmal Suliman, Muzairihana Md Moi, Yusmi Mohd Yunus, Latifah Abdul Latib & Nor Suhaila Yaacob</i>	
198	COMPRESSOR DUSTBIN	434
	<i>Siti Noor binti Abdullah, Rohani binti Yusof, Nur Amirah binti Mat Zubir</i>	
199	SURPRISE BOARD TO ENHANCE COMMUNICATION SKILLS	436
	<i>Che' Fadhilah Binti Che' Lah, Shuzura Binti Yusof, Melissa Khor Suan Chin</i>	
200	DEVELOPMENT OF FLIP CLASSROOM INTERACTIVE NOTES FOR BUILT UP RATES	438
	<i>Ross Saliha Safura Binti Hamzah, Affidah Mardziah binti Mukhtar, & Dr. Tengku Ahmad Badrul Shah Bin Raja Hussin</i>	
201	CREATE YOUR SOCIAL ENTREPRENEURSHIP (CYSE)	441
	<i>Sathiswaran Uthamaputhran, Hasannuddiin Hassan, & Mohd Ikhwan Aziz</i>	
202	WRITER BOOSTER	443
	<i>Mohd Zulkifli Muhammad, Ahmad Ridhuwan Abdullah, Zul Karami Che Musa, Azwan Abdullah, Noorshella Che Nawi, & Mahathir Muhamad</i>	
203	MUSLIMAH SAFETY BAG DEVICE	
	<i>Rohana binti Abdullah, Zunaidawati binti Mat Daud, & Azizah binti Che Musa</i>	446
204	QS JUNIOR MOBILE LEARNING APPLICATION	
	<i>Sukmawati Ismail, Nor Ashikin binti Mazlan, & Zahurin Binti Husin</i>	448
205	THE JOME CARD GAMES: FROM TEACHING INNOVATION TO COMMERCIAL GAME	450
	<i>Johan bin Ismail, Nur Eliza binti Abd. Rahman, Nurdiyana binti Ahmad Denil, Rozihan bin Mohamed, Ahmad Nasir bin Mohd. Yusoff</i>	
206	MY E-VOCABULARY PROFILE (MEVP): TEACHER'S PERSPECTIVE ON ITS USABILITY	452
	<i>Norshazrina Sabri, Liyana Ahmad Afip, Aveleena Afzan Hassan, & Nursyuhada Zakaria</i>	
207	MYOT_G: AN INNOVATIVE AND INTERACTIVE E-TEACHING METHOD FOR PRE-UNIVERSITY STUDENTS	454
	<i>Hutkemri Zulnaidi, Raihan Zainudin, & Mohd Zahurin Mohamed Kamali</i>	
208	GLOBAL UMRAHAJI GAME (GUG)	457
	<i>Prof. Dr. Azman Ab Rahman, Afaf binti Sukari, Mohamad Anwar Zakaria, Muhammad Faiz Abd. Shakor, Nurul Nadia binti Nozlan</i>	
209	LEARNING GRAPH THEORY BY USING ROTHE-Q INNOVATION METHOD	460
	<i>Nur Izzati Abd Aziz @ Mughni, Kalaiarasan A/L Subramaniam, Nik Atikah Nik Adnan, Noorul Afiah Mohamed Shuaib, Nur Fatehah Zaharim, Hutkemri Zulnaidi</i>	
210	PERMUTATION AND COMBINATION USING VELEAOFF (INTERACTIVE LEARNING OFFLINE)	462
	<i>Siti Nabila binti Sulaiman, Siti Nur Shafila binti Che Kamaruzaman, Wan Nurshairah binti Wan Mohammad Nizam, Nadiah binti Mohd Yusuff, & Hutkemri Zulnaidi</i>	
211	OPTIMISING EBOOK TO OVERCOME STUDENTS' ONLINE LEARNING CHALLENGES	464
	<i>Wan Yusoff Wan Shaharuddin, Ruzaini Ijon, Yasmin See, Mohammad Affiq</i>	

	<i>Kamarul Azlan, Mohd Asyraf Zulkfli, Nur Syahirah Mohd Nawawi, Noraini Hj. Zaini, & Julia Tan Yin Yin</i>	
212	TMCAS MODEL: REIMAGING AN IMPACTFUL VIRTUAL COLLABORATIVE PROJECT BASED LEARNING IN TEACHING ENTREPRENEURSHIP <i>Fadhilhanim Aryani bt Abdullah, Noor Raihani Binti Zainol, Nur Farihin Binti Abd Hadi Khan, Muhamad Nasyat Muhamad Nasir, Aikal Liyani Binti Mohd Rasdi</i>	466
213	CHATBOT: I'M NOT PERFECT BUT I'M HERE TO HELP <i>Wan Suzanna Aafanii Adeeba Wan Ibrahim, Nur Hafezah Hussein, Siti Bahirah Saidi, Ariezal Afzan Hassan & Amaal Fadhlini Mohamed</i>	469
214	TEACHING AND LEARNING OF THE PLAN AND ELEVATION USING GEOGLE-WALL APPROACH <i>Hutkemri Zulnadi, Fatin Farhayu Mohd Salim, Noor Syuryani Lokman, Nur Asfa Dini Azmi, Nur Hanis Nabilah Saihuddin, Nurul Shafiqah Ismail</i>	471
215	DEVELOPING WEBSITE FOR MANAGING STUDENT IN ENTERPRISE PROGRAM (SIEP) IN FACULTY OF ARCHITECTURE AND EKISTICS <i>Nuzul Haqimi Muhammad, Azlin Sharina Abdul Latef, Ismi Luqman Hamadi Bin Ibrahim, Nurul Izzati Binti Othmani, Muhammad Rizal Bin Khairuddin</i>	474
216	DIGITAL STORYTELLING: A HOLISTIC PROJECT BASED LEARNING TO ENHANCE 21st CENTURY SKILLS <i>Najihah Mahmud, Siti Amirah Ahmad Tarmizi, Amaal Fadhlini Mohamed, & Ariezal Afzan Hassan</i>	476
217	ADAPTATION OF INTERACTIVE WEB TOOLS 2.0 IN ENTREPRENEURSHIP COURSES <i>Hazrina Hasbolah, Nurul Azwa binti Mohamed Khadri, Dr. Syamsuriana binti Sidek, Dr. Yusrinadini Zahirah binti Md, Isa@Yusuff</i>	478
218	CATCH ME FOR I - SCIENCE <i>Hasanah Binti Safein @ Shafie, Muhammad Daniel Nafis Bin Ahmad, Muhammad Yahya Bin Mat Rashid, Wan Mohamad Fikri Bin Wan Shahrudin</i>	481
219	E-LEARNING IN SPANISH LANGUAGE <i>Mariyati Haji Mohd Nor, Harnani Mat Zin, Harozila Ramli</i>	483
220	i-2tor: THE 21ST CENTURY APPROACH FOR EDUCATION PLATFORM <i>Joanna Ng Row Yee, Muhammad Faizul Hakimi Bin Kamaruzzaman, Nur Farah Hanis Binti Jalalol Khaizi, Nur Zahidah Binti Muhamad Taher, Mazlan Bin Radzwan, Lelia Nastasia Binti Amlie, & Roslizawati Binti Che Aziz</i>	486
221	NEARPOD: APPLICATION OF INTERACTIVE VIRTUAL REALITY IN TOURISM COURSES <i>Nurzehan Abu Bakar, Marlisa Abdul Rahim, Nor Maizana Mat Nawawi, Siti Salina Saidin, & Suchi Hassan</i>	489
222	DIGITALIZED SUSTAINABLE SCIENCE COURSES THROUGH E-LEARNING INTERACTIVE APPROACH <i>Noor Syuhadah Subki</i>	491
223	THE USE OF STUDY APPS IN IMPROVING STUDY HABITS AMONG UNDERGRADUATE STUDENTS <i>Khairul Hisyam Bin Baharuddin, Nazatul Syima Binti Mohd Nasir, Nor Hazwani Munirah Binti Lateh</i>	493
224	ERAoI: A-10 MINUTES FORMATIVE EVALUATION APPROACH <i>Siti Hajar Ya'acob, Siti Aisyah Nawawi, Noor Syuhadah Subki, Nor Shahirul Umirah Idris, Wong Hie Ling</i>	495
225	SUBMIT A MOBILE APPLICATION FOR ASSIGNMENT DUE DATES MANAGEMENT: A MOBAGOGY <i>Siti Afiqah Binti Zainuddin, Noorul Azwin Binti Md Nasir, Tahirah Binti Abdullah, Noorshella Binti Che Nawawi, Wan Farha Binti Wan Zulkiffli, Mohd</i>	496

	<i>Nor Hakim Bin Yusoff, Siti Salwani Binti Abdullah, Ahmad Ridhuwan Bin Abdullah, Siti Rohana Binti Mohamad, Siti Nurul Shuhada Binti Deraman, Nur Farahiah Binti Azmi, Nur Izzati Binti Mohamad Anuar, Nik Alif Amri Bin Nik Hashim, & Hazriah Binti Hasan</i>	
226	“SAINS KEJURUTERAAN” SMARTPHONE APPLICATION AS AN ONLINE TEACHING AND LEARNING METHOD	498
	<i>Mohd Sanusi Deraman, Rozaimah binti Mustapa Marhaniza Ibrahim, Nurliyana Husna Ramli, Rosliza Ayob, & Anisah Jawawi</i>	
227	TIKTOKING TO IMPROVE SPEAKING SKILLS: A SOCIOCOGNITIVE CASE STUDY OF MALAYSIAN ESL LEARNERS	500
	<i>Siti Amirah Ahmad Tarmizi, Najihah Mahmud, Amaal Fadhlini Mohamed, & Ariezal Afzan Hassan</i>	
228	MOBILE LEARNING INNOVATION: PKB FINANCIAL MANAGEMENT CALCULATOR	503
	<i>Norhidayah binti Mohd Salleh & Madiha bt Hasbullah</i>	
229	MODEL OF THE INFLUENCE BY FIRM SIZE ON FINANCIAL PERFORMANCE IN MALAYSIAN ICT SECTOR	506
	<i>Mohd Fazli Bin Mohd Sam, Brenda Lim Xun Li, & Nurul Hasyimah Mohamed</i>	
230	FUND FOR FOOD: COMPLETE GUIDE TO HELP FIGHT HUNGER ON CAMPUS	508
	<i>Nurul Hafizah Mohd Yasin, Fadhilhanim Aryani Abdullah, Nur Haiza Nordin, Nur Naddia Nordin, Nur Dalila Mat Yusoff, Nik Noorhazila Nik Mud, Siti Zamanira Mat Zaib, Nurul Fardila Abd Razak</i>	
231	SOUP KITCHEN AS SOCIAL ENTERPRISE STRATEGY: A RIPPLE EFFECT THEORY	511
	<i>Noor Raihani Zainol, Anis Amira Ab Rahman, Shamsul Anuar Salim, Mohd Shahril Nizam Md Radzi, Mohd Hafis Mohd Fauzi, Nor Shuhada Ahmad Shaupi, & Azila Jaini</i>	
232	KEEP ACCOUNT YEARLY FOR SUSTAINABLE AUDIT REPORTING (KAYSAR) APPS	512
	<i>Nik Zakiah Nik Mohamed Zain, Noor Raihani Zainol, Rafiq Sharman Khamis, Mohd Hafis Mohd Fauzi, & Yohan Kurniawan</i>	
233	PROTOTYPE OF BIODEGRADABLE PACKAGING MATERIAL FROM MUSM	514
	<i>Laila Naher, Nor Alifa Mirza I, Norhafizah Md Zain, Nurhanan Abdul Rahim, Ch'ng, H.Y, M.M.Nor, Siti Maryam Salamah, & NurHusna Syahirah</i>	
234	INTEGRATING ENVIRONMENTAL ELEMENT IN MAXIMIZING BUSINESS PROFIT: AN APPLICATION OF HEDONIC PRICING METHOD	516
	<i>Nur Syafiqah A. Samad, Norzalizah Bahari, Siti Fariha Muhamad, Adi Aizat Bin Yajid, & Mohd Fathi Bin Abu Yaziz</i>	
235	AN INTEGRATED ONLINE HUB FOR MUSLIM FRIENDLY HOMESTAY OPERATORS IN MALAYSIA	518
	<i>Nadzirah Mohd Said, Derweana Bah Simpong, Hazyati Hashim, Nur Azimah Othman, Normaizatul Akma Saidi, & Wan Farha Wan Zulkiffli</i>	
236	DEVELOPING HOLISTIC PERFORMANCE MEASUREMENT INDEX FOR ISLAMIC BANKS	519
	<i>Siti Fariha Muhamad, Nur Syafiqah A. Samad, Adi Aizat Yajid, Mohd Rushdan Yasoa', Muhamad Nasyat Muhamad Nasir, Fahru Azwa Mohd Zain</i>	
237	DIAGNOSIS FRAMEWORK OF PERSONAL CASH FLOW STATUS VIA I-KFC	521
	<i>Azwan Abdullah, Mohd Nazri Zakaria, Noormariana Mohd Din, Mohd Ikhwan Aziz, Mohd Zulkifli Muhammad, Wan Ahmad Amir Zal Wan Ismail, Tengku Fauzan Tengku Anuar, Nurhanan Abdul Rahman, Hafizi Mat Salleh, & Siti Asma Md Rasdi</i>	
238	B40 SINGLE MOTHER MICRO ENTREPRENEUR EMPOWERMENT PROGRAM THROUGH ONLINE TRAINING AND MONITORING	525
	<i>Mohammad Noorizzuddin Nooh, Jamal Abdul Nassir Bin Shaari, Norhaziah Nawai, Mohd Shukor Harun, Nurul Aini Muhamed, Mahdhir Abdullah, &</i>	

	Zulkifly Mohd Zaki	
239	FRESHGO CLOUD DATA WAREHOUSE CONCEPT WITH MUTUALISTIC ECOSYSTEM <i>Intan Nurrachmi, Anthon Budyana, Hardyansyah, & Rizky Alamsyah Nurdianto</i>	527
240	HUB FOR SOCIAL ENTREPRENEURSHIP (HUBSOE): CATALYSING IMPACTFUL INNOVATIVE SOLUTION TO SOCIAL AND ENVIRONMENTAL SUSTAINABILITY <i>Noor Raihani Zainol, Anis Amira Ab Rahman, Nurul Izyan Mat Daud, Zul Karami Che Musa, Nur Ain Ayunni Sabri, Mohd Zulkifli Muhammad, Roselina Ahmad Saufi, Fatin Najihah Nik Muhammad</i>	530
241	G-ROLES: FBS MODEL <i>Nurul Ashykin Abd Aziz, Nik Syuhailah Nik Hussin, Zuraimi Abdul Aziz, Hasif Rafidee Hasbollah, & Mohd Hizam Hanafiah</i>	532
242	MAGIC WOODEN FOLDING TABLE <i>Siti Hajar Binti Mud Ariff, Maizatul Aisya Binti Ab Halim, Nur Fatin Syafiqah Binti Mazani, Nur Anis Ayunie Binti Kamarudin, Nur Anisah Binti Idzuwan</i>	535
243	MINI HAND SANITIZER <i>Norbaini Binti Ghazali, Nik Umira Fatinn Bt Nik Ismail, Koh Liew Min</i>	537
244	AYAM PERCIK PRE-MIXED POWDER <i>Noraida binti Ismail @ Yusof, Juli Suzlin binti Mohd Jalaludin, Nur Alifah Hafizah binti Ezairoskan, Nurul Shahida binti Jusoh @ Yusoff</i>	539
245	UIJA TWIST <i>Razia Malini binti Mohamad, Rosilah binti Wok, Syahidatul Aqma binti Mohd Zamri, Nurul Izzaty Akmal binti Ropi, Faridatul Hamidah binti Zulkifli</i>	541
246	CROWDFUNDING AS A TOOL FOR ENTREPRENEURSHIP EDUCATION IN HEIs <i>Ahmad Ridhwan Abdullah, Zul Karami bin Che Musa, Siti Salwani binti Abdullah, Dzulkifli bin Mukhtar, Muhammad Naqib Bin Mat Yunoh, Mohd Shahril Nizam Bin Md Radzi, Mohd Zulkifli bin Muhammad, Mahathir bin Muhamad, Abd Aziz Bin Mat Hassan, Siti Afiqah Binti Zainuddin, Siti Rohana Binti Mohamad, Nur Farahiah Binti Azmi, Nur Izzati Binti Mohamad Anuar, & Siti Nurul Shuhada Binti Deraman</i>	543
247	BRIDGING THE GREEN GAP: AN INTEGRATED FRAMEWORK TO UNDERSTAND CONSUMERS' ACTUAL CONSUMPTION DRIVING FORCES TOWARD ORGANIC FOOD IN MALAYSIA <i>Brahim Chekima, Azaze-Azizi Abdul Adis, Suddin Lada, Rozilee Asid, & Toh Pei Sung</i>	545
248	PI-ASISSTANT COMBO: PROMOTION ITEM COMBO TOOL TOHELP RETAIL INDUSTRIES TO SET OPTIMAL PROMOTION ITEMS <i>Ts. Dr. Wan Nor Munirah Ariffin, Ts. Muhamad Hafiz Masran, Dr.Nor Azrita Mohd Amin, YM Prof. Dr. Hjh Raja Suzana Raja Kasim, Dr. Emy Aizat Azimi, Prof. Ts. Dr. Mohd Mustafa Albakri Abdullah</i>	547
249	KETAPANG POUCH <i>Roslina bt Ab Rahman, Muhammad Mukhlis bin Hamdan, Nur Azlin Asyikin binti Azizi, Muhammad Naim Aiman bin Razali</i>	549
250	MODELING THE TALENT SHORTAGE THROUGH SUPPLY AND DEMAND ATTRIBUTES FOR YOUTH IN ISLAMIC BANKING INSTITUTION <i>Mohd Ikhwan Aziz, Hassanuddin Hassan, Sathiswaran Uthamaputhran, Azwan Abdullah, Siti Norjannah Mohd Jamil</i>	550
251	SUSTAINABLE eHALAL AGROCHAIN MARKETPLACE USING BLOCKCHAIN INNOVATION <i>Raja Suzana Raja Kasim, Amir Shafiq Abdullah, Zulazli Hashim, Nurul Afiqah Zulazli, & Wan Nor Munirah Ariffin</i>	552
252	MAPPING OF TOURISM IN JELI, KELANTAN THROUGH AUGMENTED REALITY (AR) APPLICATION <i>Norazlinda Mohamed Rosdi, Daeng Haliza Daeng Jamal, Max Martin Petel, Hazrina Hasbolah</i>	556

253	My Escapade! APPS: EXPLORING ADVENTURE TOURISM DESTINATION <i>Siti Nur Farhana Dzulkipli, Nor Azwani Anuar, Zahidah Mad Loddin, Roslizawati Che Aziz, & Nik Alif Amri Nik Hashim</i>	558
254	ULAM COOKIES <i>Derweanna Bah Simpong, Nur Azimah Othman, Normaizatul Akma binti Saidi, Hazyati binti Hashim, Nadzirah binti Mohd Said, & Wan Farha binti Wan Zulkiffli</i>	561
255	MALAYSIAN TREE SELECTION MODEL FOR RIGHT TREE SPECIES <i>Ramly Hasan, Nor Hamizah Abdul Hamid, Wan Saiful Nizam Wan Mohamad, & Noorliyana Ramlee</i>	565
256	1CLICK BUDGET TRAVEL:ONE-STOP PLATFORM FOR BUDGETING TRAVELLER <i>Mallini A/P Anparasan, Dhivyaa A/P Selvalumaran, Khirrun An Nisa Bahaudin, Elly Maya Masnida Othman, Chua Hui Qi, Leong Wen Qin, & Roslizawati Che Azi</i>	567
257	TAMI MULTIPURPOSE HAND SANITIZER <i>Velan Kunjuraman, Fatimah Zahra Dahalan, Mohd Saiful Jamil, Nur Ain Syafiqah Asha'ari, Wan Muhammad Aqramin Wan Othman, Damayanti Tindo Purwanto, Fatin Nur Hazwani Haron, Nurin Hazirah Razdi, Nurshafikah AB Majid, Nurul Nadia Najmi Azman & Nursyahira Badarudin</i>	570
258	MYh-SMART: AN INNOVATIVE APP FOR HOSPITALITY INDUSTRY <i>Velan Kunjuraman, Fadhilahanim Aryani Binti Abdullah, Noor Raihani Binti Zainol, Michelle Hoo Yean Nee, Cheah Ing Zhen, Cheong Hui Yin, Chia Choy Cheng Crystalbel, Lee Jia Jin, Lim Chai Hui, Sen Mei Lam, Tan Chin Haw, Tan Hong Lin, & Wee May Yee</i>	571
259	FAIR SKIN PRODUCT <i>Nor Syuhada Zulkefli, Fadhilahanim Aryani Abdullah, Norelisa Bakri, Nurdy'anna Nordin, Siti Munirah A. Kadir, Arisa Arifah Kamaluddin, Nur Humirah Rizwan, Nur Rusfadilah Ruslan</i>	573
260	HERB2BE HERBS TEABAG: SOLUTION TO DYSMENORRHOEA (MENSTRUAL PAIN) <i>Nur Athirah Sumardi, Fadhilahanim Aryani Abdullah, Nur Hafizah Muhammad, Ghazali Ahmad, Nur Aliah Mansor</i>	575
261	PROTOTYPE FORMATION FOR DEVELOPING HERITAGE TRAIL VIA QR CODE APPLICATION AT SUNGAI BUDOR VILLAGE, KELANTAN <i>Ramly Hasan, Shardy Abdullah, Wan Saiful Nizam Wan Mohamad, Noorliyana Ramlee, Mohammad Rusdi Mohd Nasir, Yeo Lee Bak, Wan Azlina Wan Ismail, Nurul Izzati Othmani, Syahidah Amni Mohamed, Nurfadilah Saadul Kurzi, Nor Hamizah Abdul Hamid</i>	577
262	3 LAYERS KAMPUNG SCENTED CANDLE <i>Ruzanifah binti Kosnin, Fadhilahanim Aryani binti Abdullah, Aina Mawaddah Binti Hamdanni, Diveiga A/P Poobalan, Fatin Nurliyana Binti Mohd Rosley, Izzati Binti Razlee, Khalida Najihah Binti Johan, Norshazani Binti M Hanafi, Nur Hanis Binti Mohd Nasir, Nurin Rasyidah Binti Rosli, Rohaya Binti Jonaidey, Siti Syazwina Binti Abdul Hamid</i>	578
263	SCIENTIFIC ECO-AGRO TOURISM MODEL IN MERAPOH, PAHANG <i>Muhammad Aminuddin Baqi bin Hasrizal Fuad, Mohammad Hafiz Bin Mohd Yazid, Mohamad Nur Arifuddin Bin Mad Yusof, Mohamad Izereen Bin Amat Mukri, Balakrishnan Parasuraman, Suganthi Appalasaamy, Boon Jia Geng, & Jayaraj Vijaya Kumaran</i>	580
264	EMOSIHAT: AN EMOTION BOARD GAME FOR CHILDREN <i>Siti Fatimah Ab Ghaffar, Normaizatul Akma Saidi</i>	582
265	3D ANIMATION APPLICATION FOR THE COVID-19 QUARANTINE AND LOW-RISK TREATMENT CENTRE (PKRC) DEVELOPMENT <i>Siti Aisyah Muhammad, Tengku Fauzan Tengku Anuar, Nur Athmar Hashim, Nik Nurul Hana Nik Hanafi, & Najah Md Alwi</i>	584

266	SMART JACKET: A MULTI-UTILITY TRAVEL JACKET FOR TRAVELLERS <i>Muhammad Azam Aziz, Muhammad Asyraf Najmi Azmi, Najwa Izzani Laili, Noor Syazwani Narzuwan, Murni Husna Muhamad Jehka, Sangeetha Sangkar, Previna Vijayan, Ng Huoi Hsian, Nik Alif Amri Nik Hashim</i>	586
267	MODISH TRAVEL HEATER: THE INNOVATION OF NIMBLE TIFFIN <i>Nor Dalilla Marican, Aifaa Syazwani Abdul Razak, Nurfarisha Fauzi, Nurul Najwa Nasuha Muda, Syazwani Sahwandi, Syed Muhammad Izzat, Nur Farah Wahida Saidi, Nur Nabilah Husna, Nurul Farhana Mohd Hanafi, Fatin Afikah Talib, Fatin Shahirah Sholahudin</i>	588
268	PROTOTYPE SNEAKER INSOLES SENSOR <i>Woo Wai Yee, Chan Kit Min, Chiang Zhi Ying, Hoo Jia Ming, Wong Pei See, Chin Chi Fung Tiew Yee Shan, Tchey Guat Nee, Pn.Fadhilahanim Aryani Binti Abdullah, Dr.Derweanna Binti Bah Simpong, Mohd Hafzal Bin Abdul Halim</i>	590
269	AVOCADO EL CABELLO OIL (NATURAL HAIR SERUM) <i>Fadhilahanim Aryani Abdullah, Naziatul Aziah Mohd Radzi, Nur Farah Nabilah Aina Ruslan, Nurafyrra Joha, Maryam Sahla Che Mohd, Kaiyisah Mohd Apandi, Nurin Aqilah Natasha Rosli, Haida Misnon, Izni Zulaikha Kamarezaman, Norazni Azikin Norhisham, Nur Syuhaida Safiee</i>	591
270	PROPOSING A CONCEPTUAL MODEL OF DESTINATION LOYALTY: TWO PARALLEL MEDIATORS OF PLACE ATTACHMENT AND TOURIST MOTIVATION <i>Muhamad Nasyat Muhammad Nasir, Marlisa Abdul Rahim, & Siti Fariha Muhamad</i>	594
271	THE VALUES OF HEROISM IN TOK TANGOK FOLKLORE AS A SYMBOL OF PERSONALITY AND INDENTITY OF MALAY COMMUNITY: RESEARCH ON THE PERCEPTION STUDENTS IN UNIVERSITY MALAYSIA KELANTAN THROUGH KAHOOT APPLICATION <i>Mohd Firdaus Che Yaacob, Muhammad Nur Al-Hakim Mohamad Hanafiah, & Tuan Siti Nurul Suhadah Tuan Adnan</i>	596
272	LEGENDA PUTERI SAADONG NARRATIVE APPRECIATION THROUGH 2D GAME APPLICATION <i>Fairuladilan Hamadun, Izati Nabila Marzuki, Md Ariff Ariffin, Hidayat Hamid, Suraya Md Nasir, Farrah Atikah Saari, Daeng Haliza Daeng Jamal, Tan Tse Guan, Anuar Mohd Yusof</i>	598
273	VIRTUAL HERITAGE TOUR THROUGH AUGMENTED REALITY (AR): APPLICATION ON MUSEUMS IN KOTA BHARU, KELANTAN <i>Daeng Haliza Daeng Jamal, Norazlinda Mohamed Rosdi, Izati Nabila Marzuki, Fairuladilan Hamdun, & Hazrina Hasbolah</i>	601
274	AUGMENTED REALITY (AR) NATION'S PILLARS STREET ART IN KOTA BHARU FOR URBAN REGENERATION AND TOURISM <i>Tengku Fauzan Tengku Anuar, Hani Izzaty Mohd Jamil, Wan Ahmad Amir Zal Wan Ismail, Suraya Md Nasir, Haris Abadi Abdul Rahim, Nawwal Abdul Kadir, Nur Athmar Hashim, Izati Nabila Marzuki, Md Ariff Ariffin, & Siti Aisyah Muhammad</i>	603
275	IMPROVING THE USER INTERACTION THROUGH BAMBOOSA VOID PAVILION AT HOSPITAL PASIR MAS, KELANTAN <i>Zulhilmi Zahari, Wan Azlina Wan Ismail, Ramly Hasan, Nurul Izzati Othman, & Nor Hamizah Abdul Hamid</i>	606
276	AN ENVIRONMENTAL ADAPTIVE DESIGN OF THE ECLECTIC SET <i>Lai Man Fai, Wan Azlina Wan Imail, Ramly Hasan, Nor Hamizah Abdul Hamid, Yeo Lee Bak, & Nor Diana Aziz</i>	608
277	SPACE SAVING AND SUSTAINABLE FOR CYCLIST BY COMBINATION DESIGN AS CYCLIST FRIENDLY BENCH AT SUNGAI LEMBING, KUANTAN, PAHANG <i>Lee Pui Yin, Wan Azlina Wan Ismail, Ramly Hasan, Nor Diana Aziz, Nor Hamizah Abdul Hamid, & Nurul Izzati Othmani</i>	610

278	THE CONNECTEDNESS BETWEEN SPACES TO STIMULATE THE LIVEABLE ENVIRONMENT BY THE PLEXUS IN JOHOR BAHRU CITY CENTRE, JOHOR <i>Nur Rabihtul Samsudin, Wan Azlina Wan Ismail, Ramly Hasan, Noorliyana Ramlee, Yeo Lee Bak, & Nor Diana Aziz</i>	611
279	BUBU ARCHWAY <i>Syamimi Mohd Noor, Ramly Hasan, Wan Azlina Wan Ismail, Nor Diana Aziz, Mohammed Fadzil Maharimi</i>	612
280	THE UNIQUENESS OF BLOSSOM CATCHMENT WATER <i>Aqilah Azeni, Ramly Hasan, Wan Azlina Wan Ismail, Nor Diana Aziz, Mohd Azri Mohd Jain Noordin</i>	613
281	THE ATTRACTIVE OF NEON TUNNEL DESIGN <i>Muizzuddin bin Basharudin, Wan Azlina Wan Ismail, Ramly Hasan, Nor Hamizah Abdul Hamid, Nor Diana Aziz, & Muhamad Hilmi Mohamad @Masri</i>	615
282	GERBANG MEK MAS AS A NEW ICONIC STRUCTURE AT KAMPUNG PANTAI MEK MAS, KOTA BHARU <i>Muhammad Aslam Husaini Mohd Sapuan , Ramly Hasan, Wan Azlina Wan Ismail, Syahidah Amni Mohamed, & Nor Diana Aziz</i>	616
283	SINGGAH JELAPANG AS PARADIGMATIC STRUCTURE AT PENDANG TOWN <i>Noor Saadah Hussain, Ramly Hasan, Wan Azlina Wan Ismail, Muhamad Hilmi Mohamad @ Masri, Syahidah Amni Mohamed, & Nor Diana Aziz</i>	617
284	SMART SCULPTURE BENCH <i>Siti Fatin Hamida Zinun, Ramly Hasan, Wan Azlina Wan Ismail, Nor Diana Aziz, & Muhamad Hilmi Mohamad @ Masri</i>	618
285	TRADITIONAL ELEMENT OF MALAY TERENGGANU: INTRODUCING GAZEBO PERMAI AT SUNGAI TAROM PUBLIC PARK, SETIU, TERENGGANU <i>Mohamad Hazmie Bin Rusdi , Wan Azlina Wan Ismail, Ramly Hasan, Nor Diana Aziz, & Mohd Azri Mohd Jain Noordin</i>	620
286	AGRONOMICAL SHELTER AS AN EDUCATION CENTER FOR URBAN FARMING AWARENESS <i>Amirul Hidayat Hussin, Wan Azlina Wan Ismail, Ramly Hasan, Noorliyana Ramlee, Nor Diana Aziz</i>	621
287	SOLVING THE COASTAL EROSION AND SUSTAIN THE COASTAL ECOSYSTEM THROUGH THE ECO FRIENDLY DEFENDER AT PANTAI IRAMA, BACHOK, KELANTAN <i>Leong Kam Hung , Wan Azlina Wan Ismail, Ramly Hasan, Noorliyana Ramlee, & Nor Diana Aziz</i>	623
288	DESIGNING CREATIVE ONE STOP GETAWAY AT DANGA BAY WATERFRONT <i>Muhammad Firdaus Rahim, Wan Azlina Wan Ismail, Ramly Hasan, Nur Hafizah Ramle, & Nor Diana Aziz</i>	624
289	THE BEAUTY OF BUNGA BINTANG HYPNOTIC AT ROYAL TOWN, PEKAN PAHANG. <i>Farah Amirah Kasimi, Ramly Hasan, Wan Azlina Wan Ismail, Nor Hamizah Hamid, Yeo Lee Bak, & Nor Diana Aziz</i>	625
290	SOLVING THE SOIL DEPOSITION THROUGH THE SUSTAINABILITY OF RESILIENCE DRAINAGE SYSTEM AT BUKIT KELUANG BEACH, BESUT, TERENGGANU <i>Ahmad Huzairah Aminuddin, Wan Azlina Wan Ismail, Ramly Hasan, Nor Diana Aziz, & Mohd Azri Mohd Jain Noordin</i>	626
291	DEVELOPMENT OF POSTURE CORRECTOR DEVICE WHILE SITTING FOR DISCOMFORT PROBLEMS AMONG OFFICE WORKERS <i>Darlina Mohamad, Azmul Fadhli Kamaruzzaman, Nooraziah Ahmad, Hana Yazmeen Hapiz, Mohd Yusri Mohd Naser</i>	627
292	EXPERIENCE THE NATURE VIA SMART 'SEGAR AMAT' BRIDGE AT RECREATION PARK <i>Tan Vie Khuen , Wan Azlina Wan Ismail, Ramly Hasan, Nor Diana Aziz, &</i>	630

	<i>Mohammed Fadzli Maharimi</i>	
293	REMEMBERING CULTURE ACTIVITY FOR THE USER AT PANTAI SRI TUJUH, TUMPAT	632
	<i>Nik Nabila Nik Mat, Wan Azlina Wan Ismail, Ramly Hasan, Nor Diana Aziz, & Mohammed Fadzli Maharimi</i>	
294	DEVELOPING ICONIC LANDMARK OF GREEN CURTAIN TOWER AT KOLAM HIJAU COMMUNITY PARK	634
	<i>Raja Faerull Asraf Raja Alim, Ramly Hasan, Wan Azlina Wan Ismail, Muhamad Hilmi Mohamad @ Masri, & Nor Diana Aziz</i>	
295	ADAPTIVE PRAYER WEAR FOR IMMOBILE MUSLIM WOMEN	636
	<i>Sarah Wahida binti Hasbullah, Siti Nurul Diana binti Sukri, Mohd Zaimuddin bin Mohd Zain, Hana Yazmeen binti Hapiz, Azlin Sharina binti Abdul Latef, Mohd Hafiz bin Drahan, & Nurul Syahida binti Mat Hussin</i>	
296	OMNI: TOOTHBRUSH DESIGN FOR DOWN SYNDROME CHILDREN	638
	<i>Hana Hapiz, Yuhanis Ibrahim, Sarah Wahida Hasbullah, Azlin Sharina Abdul Latef, Ainul Wahida Radzuan, Suraya Sukri, Mohd Zaimuddin Mohd Zain, Nuzul Hakimi Muhammad</i>	
297	GAPURA: APPLICATION OF 3D TECHNOLOGY VISUALISATION IN CONSERVING HERITAGE BUILDING OF ISTANA BALAI BESAR	641
	<i>Siti Aisyah Muhammad, Azli Bin Abdullah, Yasmin Binti Mohd Faudzi, Ahmad Nizam Aiman Bin Mohd Pauzi, Normaisarah Binti Mohd Rosdi, & Muhammad Arib Muzakkir Bin Mohd Salleh</i>	
298	FLUX: A MODULAR 3D PRINTED FURNITURE JOINERY SYSTEM	644
	<i>Muhamad Ezran Zainal Abdullah, Nor Hamizah Abdul Hamid1, Jarfrulhizam Jaafar, Mohd Hilmi Harun, Siti Nurul Diana Sukri, Mohd Firuz Mohd Anwar, Darliana Mohamad, & Nooraziah Ahmad</i>	
299	GERBANG KOLEK: FASHIONING AN ICONIC UMK GATEWAY	646
	<i>Juliza Mohamad, Muhammad Rizal Khairuddin, Azli Abdullah, Nik Nurul, Hana Hanafi, Siti Aisyah Muhammad, Nor Hafizah Anuar, Najah Md Alwi, Yasmin Mohd Faudzi, Mhd Hafiz Karami Mhd Zain, Nuzul Haqimi, & Muhammad Ismi Luqman Hamadi Ibrahim</i>	
300	IE-SMART TRACKER 3.0 (INTELLIGENT EMPLOYABILITY SMART TRACKER 3.0)	649
	<i>Khairul Azhar Mat Daud, Balakrishnan Parasuraman, & Ena Bhattacharyya</i>	
301	MODEL OF DEPRESSION, ANXIETY AND STRESS, EMOTIONAL INTELLIGENCE AND SATISFACTION OF WORK-LIFE BALANCE	650
	<i>Rogis Baker, Hassan Al-Banna Mohamed, Nur Fatimah Husna Mohamad Puzi, Nur Surayya Mohd Saudi, Haliza Mohd Zahari</i>	
302	NEW INTEGRATION MODEL OF HUMAN DIMENSIONS WITH MILITARY MINDS AND PATRIOTISM AMONG MALAYSIAN ARMED FORCES	652
	<i>Jessica Ong Hai Liaw, & Nora Ibrahim</i>	
303	INTERPRETATION OF NATURE IN LITERATURE THROUGH FILM ADAPTATION	656
	<i>Sudirman Kiffli, Nordiana Ab Jabar, Suraya Sukri, Ainul Wahida Radzuan, Farrah Atikah Saari, & Siti Nur Anis Muhammad Apandi</i>	
304	RELIGION AS PEACEBUILDING: A CASE OF SABAH SOCIAL ENVIRONMENT	658
	<i>Suraya Sintang, Romzi Ationg, Mohd Nazmi Mohd Khalli, Khadijah Mohd Khambali @ Hambali, Syamsul Azizul Marinsah</i>	
305	ESTABLISH SPATIAL STATISTICS SYSTEM DESIGN FOR POVERTY RISK ESTIMATION	661
	<i>Siti Aisyah Nawawi, Norashikin Mohd Fauzi, Amal Najihah Muhamad Nor, Norfadhilah Ibrahim, Rohazaini Muhammad Jamil, Siti Hajar Ya'acob, Wan Nur Fazni Wan Mohamad Nazarie, Rabihah Nawawi</i>	
306	BIBLIOMETRIC: JURIMETRICS TO DETERMINE REFERENCES ON LEGAL CASES IN MALAYSIA	663
	<i>Adi Aizat Yajid, Abdul Khabir Rahmat, Ahmad Ridhwan Abdullah, Nur Syafiqah A. Samad, Norzalizah Bahari, Siti Fariha Muhamad</i>	

307	A MODELING STUDY OF THE ECONOMIC EMPOWERMENT OF WOMEN IN THE FIELD OF ENTREPRENEURSHIP IN KELANTAN <i>Zaleha Embong, Fairuz A'dilah Rusdi, Asma Lailee Mohd Noor, Wan Ahmad Amir Zal Wan Ismail</i>	665
308	FUTURE HOMES: INTEGRATION ELEMENT OF A HEALTHY HOME AND SMART SYSTEM TO ENHANCE WELLBEING FOR ALL <i>Siti Nuratirah bt Che Mohd Nasir, Salmiah bt Aziz, Nur 'Izzati bt Mohd Amin, Dr WaOmar Ali Saifuddin b Wan Ismail</i>	667
309	DEVELOPMENT OF A MODERATED FINANCIAL STRAIN MODEL AMONG HOMEOWNERS WITH THE JOB SATISFACTION-DEBT BEHAVIOUR INTERACTION <i>Husniyah A. Rahim, Zahariah Sahudin, Amirah Shazana Magli, Mohd. Fazli Sabri, Mohd. Amim Othman</i>	669
310	USE ME HEALTH RECORD (UMHR) <i>Khairunisa Nasuha Ahmad Kamal, Damia Nazifa Al Hashimi, Muhammad Akmal Hazim Fairusdzuddin & Afzanizam Alias</i>	672
311	PRINCIPLES OF RESPONSIBILITY IN THE MEDINA CHARTER TO BUILD COOPERATIVE RELATIONS OF THE CROSS-CULTURAL SOCIETY <i>Zaleha Embong, Fairuz A'Dilah Rusdi, Asma Lailee Mohd Noor, Ateerah Abd Razak, Nik Yusri Musa¹, Nur Azuki Yusuff, Noor Shakirah Mat Akhir, Nazri Muslim</i>	674
312	THE DOLLS KIT FOR EFFECTIVE INTERVIEW MAPPING STRATEGY (A MODEL FRAMEWORK) <i>Yohan Kurniawan, Mohammed Farhan Bin Md Yusof, Noor Raihani Binti Zainol, Yang Jia Qi</i>	676
PART 3: LIST OF CONTRIBUTORS STEAM		678
313	WATERPROOF FIRESTARTER FOR OUTDOOR ACTIVITY <i>Saliza Anida Salleh, Yumna Fatima Khan, Nuralya Qaisara Mohd Hashim, Aydin Shamsul, Shamsul Muhamad</i>	679
314	DRONE@SCHOOL: NARROWING DIGITAL DIVIDE, INCREASING S.T.E.M CURIOSITY <i>Noor Janatun Naim Jemali, Mohamad Radi Mohamed Rosly, Marinah Muhammad, Shaparas Daliman, Muhammad Firdaus Abdul Karim, Aqilah Abdul Rahim</i>	680
315	SYSTEMATIC SYNTHETIC PHONICS: AN EVALUATION OF THE EFFECTIVENESS OF USING THE JOLLY PHONICS PROGRAMME TO TEACH READING <i>Norfarisha Elyana Abdullah, Najihah Mahmud, Nazirah Mahmud</i>	682
316	DESIGNING AND DEVELOPING YEAR ONE SCIENCE PEDAGOGICAL MODULE BASED ON STEAM LEARNING MODEL <i>See Too Kay Shi & Assoc. Prof. Dr Ng Siew Foen</i>	683
317	WATER POLLUTION <i>Yumna Fatima Khan, Saliza Anida Binti Salleh, Mohammad Muqtada Ali Khan, Hafzan Eva Manosr, Elvaene James</i>	685
318	YOGURTINI – A BENEFICIAL YOGURT WITH NATURAL STINGLESS BEE (MELIPONINI) HONEY'S JELLY GUMMY <i>Khairinawati Binti Shuib, Nor Syawalnie Binti Ghazali, Nor Alisya Maisarah Binti Norhisham, Muhd Al-Amin Shah Bin Mohd Asmadi, Aniff Bin Affenddy, Muhammad Sabri Bin Saidi, Aniq Fahmi Bin Mohammad Zainal, Nur Alia Maisarah Binti Nawawi, Muhd Danial Irfan Bin Mohammad Zu, Nur Ainatul Amani Binti Isa, Nur Athirah Binti Mohd Sayuti, Azhaney Binti Abdullah, Azfi Zaidi Bin Mohammad Sofi Aziz, Nor Hakim Bin Abdullah</i>	687
319	PRODUCTION OF BIOGROWTH POT (BIO-G POT) FROM LOCAL AGRICULTURE WASTE FOR CROP SEEDLING APPLICATION <i>Azhaney Binti Abdullah, Aniq Fahmi Bin Mohammad Zainal, Nur Alia</i>	689

Maisarah Binti Nawawi, Muhd Danial Irfan Bin Mohammad Zu, Nur Ainatul Amani Binti Isa, Nur Athirah Binti Mohd Sayuti, Nor Syawalnie Bt Mohd Ghazali, Nor Alisya Maisarah Binti Norhisham, Muhd Al-Amin Shah Bin Mohd Asmadi, Aniff Bin Affenddy, Muhamad Sabri Bin Saidi, Khairinawati Binti Shuib, Nor Hakim Bin Abdullah, & Azfi Zaidi Bin Mohammad Sofi@Aziz

- | | | |
|-----------------------------------|---|-----|
| 320 | TRIMBOT: REMOTE CONTROL LAWN MOWER
Wan Nur Batrisyia Irwan, Muhammad Muaz Lasim, Zulaiqah Badrul Isham, Zalina Ahmad, Norulshaidah Mohamad, Raja Noor Farah Azura Raja Ma'amor Shah | 691 |
| 321 | BOM WARISAN
Al-Aqif Hafez bin Al Kamalrolzaman, Nur Iman Amani binti Khairil-Iszuddin, Fathin & A'liya binti Mohamad Jamaludin | 693 |
| 322 | EnviroMPlasc (FOOD PACKAGING FROM COCOPEAT, LEMONGRASS AND COGON GRASS)
Najwa Ariena Mohamad Azizie, Siti Nur Eleysa Maisarah Abdul Rahim, Thasni Balqis Mohammad Yusof, Nur Aqish Putri Mohd Zailani, Nur Aini Rosdi, Nor Zaihan Shamsudin | 694 |
| 323 | POTATO AS A POTENTIAL ORGANIC WATER CARRIER UTILIZED IN REDUCING SALINITY IN SALT SOLUTION
Afifah binti Abdul Azmil, Nurul `Izzan binti Abdul Razak, Muhammad Safwan Bin Khairudin, & Muhammad Azan bin Tamar Jaya | 697 |
| APPENDIX A: LIST OF JUDGES | | 699 |

FOREWORD BY THE VICE CHANCELLOR UNIVERSITI MALAYSIA KELANTAN

Assalamualaikum Warahmatullahi Wabarakatuh.

In the Name of Allah, the Most Gracious, the Most Merciful.

It gives me great pleasure to welcome all participants and presenters to the Carnival of Research and Innovation (CRI2021) jointly organized by Universiti Malaysia Kelantan and Politeknik Kota Bharu in conjunction with the International Virtual Innovation & Invention Challenge (INTELLIGENT) 2021 and Creative Innovation Carnival (CIC) 2021, and supported by National STEM Association. I would also like to congratulate the organizers for their sheer dedication and an unwavering commitment in making this event a success. I believe organising such an event during this unprecedented time due to the Covid-19 pandemic has been quite a challenge to everyone involved.

CRI 2021 serves as a platform to encourage researchers, educators as well as industry players from various fields and organisations to share their research and showcase their innovations. This synergy is hoped to be able to provide the participants with new knowledge and further nurture their creative minds to produce more quality research and innovations in the future for the benefit of the whole society.

I'd like to draw your attention to STEAM (Science, Technology, Engineering, Arts & Mathematics), one of the categories introduced in the carnival. Having the school community take part in this event is a good way to create awareness especially among students about the importance of research and innovation in education. Such exposure helps develop their creativity as well as problem solving skills and familiarises them with research culture at an early age.

It is also important to note that both research and innovation are central in stimulating economic growth. I believe that some of the research projects and innovations presented at this carnival have enormous commercialisation potential. Consider this platform as a steppingstone for your innovations & inventions to be made visible and later commercialised for many to benefit from.

Finally, Universiti Malaysia Kelantan, through our Research Management and Innovation Centre (RMIC) is committed to empowering research and innovation among our staff. With grant applications open for both academic and non-academic staff and awards to acknowledge their accomplishments speak volumes of our commitment on this matter. CRI 2021 is also part of our continuous effort to strengthen our research agenda especially in response to the demands of the Fourth Industrial Revolution that is gradually taking place.

Once again, I would like to congratulate everyone who has devoted their time and effort in making CRI 2021 a reality. I wish all of you a very successful event and all the best in your future research endeavours.

Thank You

Prof. Dr. Nik Maheran Binti Nik Muhammad
Exercising the Function of Vice Chancellor
Universiti Malaysia Kelantan

FOREWORD BY THE SENIOR DIRECTOR OF RESEARCH MANAGEMENT AND INNOVATION CENTRE UNIVERSITI MALAYSIA KELANTAN

Assalaamu'alaikum Warahmatullahi Wabarakatuh.

In the Name of Allah, the Most Gracious, the Most Merciful.

It is a great and a heart-warming pleasure for me to welcome everybody to Carnival of Research and Innovation – Virtual International Edition – (CRI 2021). The success of last year's event drives us to go bigger and global! This year Universiti Malaysia Kelantan and Politeknik Kota Bharu, supported by National STEM Association co-organise CRI 2021 in conjunction with the International Virtual Innovation & Invention Challenge 2021 (INTELLIGENT) and Creative Innovation Carnival (CIC) 2021. I would like to extend my gratitude to all organising committees for excellent works and passionate efforts.

Ladies and gentlemen,

It has been almost two challenging years since the start of pandemic in Malaysia. This has impacted us in every aspect of our lives. However, we must not hold ourselves back, but keep up the momentum to bounce back stronger. For this year's edition, we received over 350 entries from universities, collages and industries in Malaysia and Indonesia. There are 14 categories to compete involving various fields of teaching and learning, technology, innovation, business, machinery and more.

Dear friends and colleagues,

The idea of CRI is to establish a networking platform between universities and agencies as well as a place for researchers to showcase their research products to be highlighted at higher level. In doing so, we encourage continuous research and innovation from researchers towards commercialisation. Other than that, we are hoping to cultivate innovative research with high impacts for local and global communities. For your information, Carnival of Research and Innovation (CRI) is an annual signature programme under the Office of Deputy Vice Chancellor (Research & Innovation) since 2016. Back then, it was organised by Research Management and Innovation Centre under the name of Research and Innovation Exhibition. A year later, we had combined Research and Innovation Exhibition with Research and Innovation Week to reward researchers who achieved success in their researches. In the third year, the programme was renamed to Carnival of Research and Innovation (CRI 2018). This programme has been promoted as an official university programme which will be organised by the office of Deputy Vice Chancellor of Research & Innovation annually.

For 2019, we involved participants from schools to expose them in innovative competition. Finally, we had our first virtual carnival eCarnival of Research and Innovation in 2020. This is an example persistence in pursuing dreams and you have my respect for that.

Ladies and gentlemen,

Before I'm ending my speech, I would like to thank and congratulate everyone that directly and indirectly involved with the carnival. Keep up the momentum and pray to God that this event will be continued in coming years to give chances to other researchers, inventors and educators to highlight and showcase their best creative innovative ideas. May God bless this programme so it fulfils the objectives and brings benefits to all of us. Please enjoy all the activities prepared for the day.

Thank you.

Prof. Ir. Ts. Dr. Prof. Ahmad Ziad bin Sulaiman

Senior Director

Research Management and Innovation Centre

Universiti Malaysia Kelantan

FOREWORD BY THE DIRECTOR OF POLITEKNIK KOTA BHARU

Assalaamu'alaikum Warahmatullahi Wabarakatuh.

In the Name of Allah, Most Gracious, Most Merciful.

It is my pleasure to welcome everyone to the International Virtual Innovation & Invention Challenge 2021 (INTELLIGENT) in conjunction with Carnival of Research and Innovation 2021. This virtual international event is proudly organized by Universiti Malaysia Kelantan and jointly organized by Politeknik Kota Bharu and the Department of Polytechnic and Community College Education, Ministry of Higher Learning Malaysia. I would like to take this opportunity to thank all the organizing committees for the hard work and effort for making this event a resounding success in terms of participation and organization.

Due to the outbreak of COVID-19 and corresponding to the Malaysian Government Order on Movement Control Order (MCO), INTELLIGENT 2021 is organized virtually. However, despite the pandemic, more than 370 participants from various categories had participated. This overwhelming response clearly shows that nothing can stop us from learning and striving to be the best in facing global challenges and obstacles.

INTELLIGENT 2021 is a great stage for innovators and researchers in showcasing creative ideas and innovations of various categories. There are three categories that involve various fields of studies covering science technology, social sciences and STEAM or Science Technology, Engineering, Arts and Mathematics. This innovation competition is open to all innovators from higher learning institutions and schools.

This distinctive program is in line with the strategies in Malaysia Education Blueprint 2015-2025 for Higher Education in producing great talents, ecosystem innovation and global E-Learning. Hence, this platform has served as a medium to put forward the innovations and creative ideas that are developed by students, teachers and lecturers in order to meet the challenges of Industrial Revolution 4.0.

Therefore, the innovations are expected to improve productivity in all sectors. Apart from that, the innovators and researchers require supports and motivation to generate creative minds to design quality and useful innovations. The positive impacts of the innovations will change how we live, work, and communicate. Thus, I believe this platform will greatly benefit and contribute to the new ideas in teaching and learning development.

Finally, once again, I congratulate all the organizing committees, participants and presenters. Keep up the good work and hopefully this event will be able to raise awareness and encourage more educators and researchers to continuously produce excellent quality of innovations and inventions. May this event run smoothly and achieve its objectives in uplifting the country's education to a greater level.

Thank you.

Kamaludin bin Daud
Director
Politeknik Kota Bharu

PREFACE BY CHIEF EDITOR

This e-Proceedings contains a compilation of 323 selected papers from the Carnival of Research and Innovation (CRI 2021) – Virtual International Edition. This event was held at Universiti Malaysia Kelantan (UMK) via online platform on the 20th to 21st September 2021. CRI 2021 was held in conjunction with the International Virtual Innovation & Invention Challenge (INTELLIGENT) 2021 and Creative Innovation Carnival (CIC) 2021. It aims to provide platform for academics, researchers, practitioners and students to showcase their products, research and innovation and at the same time to share their expertise and creativity. It also aims to cultivate interests and encourage lecturers and students to develop teaching materials in line with current technological developments.

It was gratifying to all of us on the overwhelming response for CRI 2021 as we received more than 300 submissions from various areas of related fields in science and technology, social sciences and STEAM. After a peer-review process, the editors have accepted 323 papers for the e-proceedings that cover 14 categories. All contributions express the different expertise, experiences, contexts and knowledge which have been compiled into this e-proceeding as a true collection of intellectual, effort and wonderful diversity.

With the large number of submissions, the event has achieved its main objective which is to bring together educators, researchers, practitioners and students to share their findings and perhaps sustaining the research culture in the university and school.

As chief editor, it has been a great pleasure for me to preside over the review of the e-proceedings and I sincerely would like to thank the contributing authors for their cooperation in refining the manuscripts to meet the scholarly requirements while at the same time meeting the tight deadlines.

I would also like to express my appreciation to fellow members of the Publication Committee for devoting their time and effort in compiling and reviewing the selected papers for this e-proceedings as well as the designer for the excellent cooperation in preparing the e-proceedings of CRI 2021. We hope that this e-proceedings will serve as a valuable reference for researchers, academics and students.

Thank you.

Nur Hafezah Hussein

Chief Editor

e-Proceedings of CRI 2021

ORGANIZING COMMITTEE

Advisors	<p>Prof. Ir. Ts. Dr. Ahmad Ziad Bin Sulaiman Senior Director of Research and Innovation Management, Universiti Malaysia Kelantan</p> <p>Ts. Zainab Binti Ahmad Director-General of Polytechnic and Community College Education Department, Ministry of Higher Education</p> <p>Mr. Kamaludin Bin Daud Director of Kota Bharu Polytechnic</p>
Head of the Secretariat	<p>Assoc. Prof. Ir. Dr. Julie Juliewatty Binti Mohamed</p> <p>Ym Dr. Tengku Ahmad Badrul Shah Bin Raja Husin</p> <p>Dr. Zubaidah Binti Aman</p> <p>Dr. Ishak Bin Mohamad</p>
Assistant Head of the Secretariat	<p>Assoc. Prof. Ts. Dr. Tan Tse Guan</p> <p>Assoc. Prof. Dr. Yohan Kurniawan</p> <p>Mr. Chung Boon Chuan</p>
Secretariat	<p>Head: Mrs. Nurul Iman Binti Hj Mohd Zain</p> <p>Members:</p> <p>Mr. Syed Ahmad Afiq Hasif Bin Syed Ab Rahman</p> <p>Mrs. Roslinda Binti Ismail</p> <p>Mrs. Roslida Binti Abdul Rahman</p> <p>Dr. Anwar Bin Hamid @ Pa</p> <p>Mrs. Suzianah Binti Sahar</p>
Finance	<p>Head: Mrs. Lidyawati Husniza Binti Mohd Zahari</p> <p>Members:</p> <p>Mrs. Nooraida Faziela Binti Ahmad Amin</p> <p>Mrs. Nur Afifah Binti Ahmad</p> <p>Mr. Khairul Azhan Bin Zakri</p> <p>Mrs. Farah Binti Ariffin</p> <p>Mrs. Wan Farizan Binti Wan Ibrahim</p>
Invitation & Registration	<p>Head: Dr. Zaleha Binti Embong</p> <p>Members:</p> <p>Miss Chin Siao Mei</p> <p>Mrs. Nurul Aadilah Binti Salleh</p> <p>Dr. Sarah Wahida Binti Hasbullah</p> <p>Dr. Mohd Zaimmudin Bin Mohd Zain</p> <p>Dr. Hana Yazmeen Binti Hapiz</p> <p>Mrs. Rozaimah Mustapa</p> <p>Mrs. Fatimah Binti Abdul Rahman</p> <p>Mrs. Nur Filzah Binti Mohd Fauzey</p>
Judging	<p>Head: Ts. Dr. Darliana Binti Mohamad</p> <p>Members:</p> <p>Mrs. Wan Suzanna Aafanii Adeeba Binti Wan Ibrahim</p> <p>Miss Alia Nadhirah Binti Ahmad Kamal</p> <p>Assoc. Prof. Ts. Dr. Tan Tse Guan</p> <p>Mr. Zuhairy Bin Zahari</p> <p>Mr. Udom A/L Ewon</p>

Gift & Certificate	<p>Head: Mrs. Nur Athmar Binti Hashim</p> <p>Members: Miss Chua Hui Wen Miss Shahidatul Maslina Binti Mat So'od Mrs. Nor Fazura Binti Md Zulkifle Mrs. Nor Hanim Binti Mustafa Dr. Norazlinda Binti Mohamed Rosdi Dr. Daeng Haliza Binti Daeng Jamal Mrs. Norhapiza Binti Md Noor Miss Nur Farhana Binti Shuhaimi Mr. Muhammad Nafizie Bin Elias Mrs. Rosilah Binti Wok Mr. Wan Muhammad Marzudi Bin Wan Muhammad</p>
Promotion & Publicity	<p>Head: Mr. Arifuddin Bin Abdullah</p> <p>Members: Mr. Wan Yusoff Bin Wan Shaharuddin Assoc. Prof. Ts. Dr. Khairul Azhar Bin Mat Daud Assoc. Prof. Ts. Dr. Nik Zulkarnaen Bin Khidzir Mrs. Nurulahda Binti Sulaiman Mrs. Farrah Atikah Binti Saari Mr. Azmi Bin Ayub Mr. Rozaidi Bin Ismail Mr. Rodey Hamza Bin Hamzah Mrs. Siti Martini Binti Mustapha Mrs. Melissa Khor Suan Chin</p>
Sponsorship	<p>Head: Mr. Aziz Bin Mamat</p> <p>Members: Mrs. Zuriati Binti Mohd Rashid Mrs. Tg. Iffah Binti Tuan Yazid Mr. Md Ariff Bin Ariffin Miss Izati Nabila Binti Marzuki Mrs. Aspalila Binti Awang Mrs. Rosnani Bt. Hassan</p>
Publication	<p>Head: Dr. Nur Hafezah Binti Hussein</p> <p>Members: Dr. Nor Hazwani Munirah Binti Lateh Mrs. Liyana Binti Ahmad Afip Mr. Tenh Hock Kuan Ts. Dr. Anuar Bin Mohd Yusof Mr. Mohammad Syukran Bin Kamal Ruzzaman Mr. Muhammad Najibul Muthiie Bin Che Ya'acob Assoc. Prof. Ts. Dr. Tan Tse Guan Sr. Noor Izma Binti Ab. Ghani Dr. Nik Azida Binti Abd Ghani Mrs. Wanly A/P Eh Keon Mrs. Nor Ashikin Binti Mazlan Mrs. Nor Abidah Binti Abdul Hamid</p>
Texts for Speech	<p>Head: Mrs. Linira Bt Ghazali</p> <p>Members: Mr. Arifuddin Bin Abdullah Mrs. Liyana Binti Ahmad Afip</p>

Montage	Head: Mr. Hidayat Bin Hamid Members: Mr. Mohammad Syukran Bin Kamal Ruzzaman Mr. Md Ariff Bin Ariffin Mr. Fairuladilan Bin Hamadun
Technical & Logistics	Head: Mr. Mohd Safuan Bin Mohd Azam Members: Mr. Mohd Norhisyam Bin Jaafar Mr. Rosmawi Bin Md Ali Mr. Wan Mohd Osman Bin Wan Omar Mr. Nik Kamaruddin Bin Fatanah Mr. Roslan Bin Mamat Mr. Hazmee Bin Abdul Halim
Recording & Archives	Head: Miss Rosmawati Binti Che Hassan Members: Mrs. Noor Faezah Binti Basary Mr. Mohd Safuan Bin Mohd Azam Mr. Wahyudi Yusra Bin Zulfin Mr. Mohd Khairul Azman Bin Che Ibrahim Mr. Che Seman Bin Che Cob
ICT & Equipment	Head: Mr. Ahmad Bustaman Bin Arifin Members: Mr. Khairul Ikhwan Bin Mohd Sukri Mrs. Suzianna Binti Taib Mrs. Siti Zaleha Binti Ibrahim



CRI 2021

CARNIVAL OF RESEARCH AND INNOVATION
VIRTUAL INTERNATIONAL EDITION

PART 1
SCIENCE & TECHNOLOGY

QN-OptiCal: A ROBUST CALCULATOR USING QUASI-NEWTON APPROACH FOR SOLVING MATHEMATICAL EQUATION

Azfi Zaidi Mohammad Sofi

Universiti Malaysia Kelantan Kampus Jeli, Kelantan, Malaysia
 azfi.ms@umk.edu.my

Sarizam Mamat¹, Nurul Akmar Che Zaudin¹, Nor Hakimin Abdullah¹, An'amt Mohamed Noor¹, Andi Hermawan¹, Abdul Hafidz Bin Yusoff¹, Sharizal Ahmad Sobri,¹ Teo Pao Ter¹, Mohd Asrul Hery Bin Ibrahim¹, Khairul Nizar Syazwan¹, Hasyiya Karimah Adli¹, Arlina Ali¹, Muhammad Iqbal Ahmad¹, Mohamad Bashree Abu Bakar¹, Hafiz Mohd Hanafi², Khirulnizam And Rahman², Nur Muizz Mohamed²

¹Universiti Malaysia Kelantan Kampus Jeli, Kelantan, Malaysia

²Kolej Universiti Islam Antarabangsa Selangor, Selangor, Malaysia

sarizam@umk.edu.my, akmar@umk.edu.my, norhakimin@umk.edu.my, anamt@umk.edu.my, andi@umk.edu.my, hafidz.y@umk.edu.my, sharizal.s@umk.edu.my, teopaoter@umk.edu.my, hery.i@umk.edu.my, nizar.w@umk.edu.my, hasyiyaa@umk.edu.my, arlina@umk.edu.my, iqbal.a@umk.edu.my, bashree.ab@umk.edu.my, hafizhanafi@kuis.edu.my, khirulnizam@kuis.edu.my, muizz@kuis.edu.my

Highlights: A large scale of high degree complicated equation (higher degree function that has many variables) is hard to solve and sometimes is impossible to solve even by using a mathematical software. Therefore, we introduce a calculator namely OptiCalc by using quasi-Newton approach method and this new robust calculator is able to solve a complicated function efficiently compared to existing calculator. OptiCalc calculator has higher percentage of success rate of solving complicated equation and it is faster than existed calculator in term of time computing.

Key words: Optimization calculator, quasi-Newton

Introduction:

Quasi-Newton method is known as one of the best and most efficient iterative method for solving optimization problem function

$$\min_{x \in \mathfrak{R}^n} f(x) \tag{1}$$

where f is twice continuously differentiable function from \mathfrak{R}^n into \mathfrak{R} . Quasi-Newton method use the Hessian update formula

$$B_{k+1} = B_k - \frac{B_k s_k s_k^T B_k}{s_k^T B_k s_k} + \frac{y_k y_k^T}{s_k^T y_k} + \phi_k (s_k^T B_k s_k) w_k w_k^T, \tag{2}$$

In its algorithm. This formula is very powerful and it make the algorithm more robust and efficient when it is used. The OptiCalc calculator use the formula (2) in its algorithm and it make the calculator is more robust. The OptiCalc is very efficient in order to solve the complicated mathematical function as shown in Figure 1.

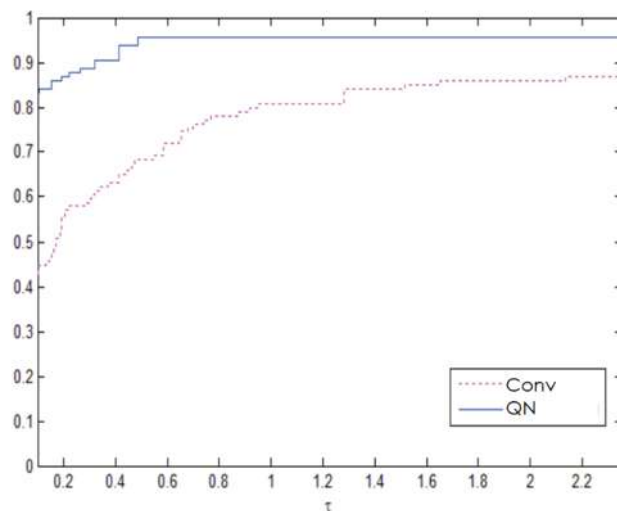

Figure 1: Comparison between OptiCalc and Previous Calculator Software

Figure 1 show the comparison between OptiCalc and previous calculator software represented by blue line and dotted red line respectively. Based on the performance profile graph shown in Figure 1, OptiCalc represented by blue line has faster time computing and has higher percentage of successful rate compare to previous calculator software. The comparison of successful rate and CPU time for both of calculator shown in Table 1.

Table 1: Result for OptiCalc and Previous Calculator Software

Comparison	Successful rate	CPU time (seconds)
OptiCalc	95.54%	64.2568119
Previous Calculator Software	56.61%	75.4420836

The Quasi-Newton algorithm approach is very powerful when used in the calculator algorithm for solving equation. Calculator software developer can start using the mathematical algorithm in their calculator algorithm. The quasi-Newton algorithm used in OptiCalc clearly show that it will improve the successful rate of the calculator and reduce the computing time. Hence, OptiCalc together with quasi-Newton algorithm has a unique commercial value for calculator developer out there.

Acknowledgement:

We would like to thanks all co-authors for contributing in OptiCalc development process.

References:

- A.Z.M. Sofi, M. Mamat and I. Mohd (2013) An Improved BFGS Search Direction Using Exact Line search, Journal of Applied Mathematical Sciences, Journal of Applied Mathematical Sciences 7(2), 73–85.
- A.Z.M. Sofi, M. Mamat and M.A.H. Ibrahim, (2013) Reducing Computation Time in DFP (Davidon, Fletcher & Powell) Update Method for Solving Unconstrained Optimization Problems", AIP Conference Proceedings 1337, pp. 1337–1345.

THE 3D-BES

Jamaliah Mohamad Sopi
Politeknik Kota Bharu, Kelantan
jamaliahsopi@pkb.edu.my

Haryati Binti Ismail, Nor Asma Binti Mamat
Politeknik Kota Bharu, Ketereh, Malaysia
haryati@pkb.edu.my, nor.asma@pkb.edu.my

Highlights: The 3D-BES developed to help students visualize and understand quantity take-off work better. This innovation is designed specifically for the Building Work Measurement 4 (BWM4) course of Polytechnics Malaysia. The 3D-BES is a teaching and learning material that combines 2D drawings and 3D-model for three (3) different elements which are building work in connection (BWICs), electrical and sanitary appliances.

Key words: 3D, measurement, BWICs, sanitary, electrical

Introduction

Building Work Measurement 4 (BWM 4) course is a course that must be taken by fourth-semester students at Polytechnic Malaysia which are offered in the program of Diploma in Quantity Surveying. The syllabus in this course covers the topic of BWICs, electrical works, and sanitary appliances. This course requires students to read, visual and interpret construction drawing in order to take-off the quantity of work. According to Garmendia (2010), visualizing is a process of interpreting the views of an object which has been represented in a drawing. In the engineering field, the ability to visualize in three (3) dimensions is a cognitive skill and one of a key success (Tumkor & Harm, 2015). From the lecturer's observation, many students were lack of visualization while interpreting 2D drawing. Moreover, due to pandemic, many teaching and learning activities were conducted online. As a result, lesson delivery becomes increasingly hard. This causes students to lack of understanding of their lesson. Thus, by using a software named Floor Plan Creator, the 3D-BES developed to help students understand their lesson and visualize construction drawing better.

Content

Description of the innovation

In the BWM4 course, students are required to make quantity take-off related to the specific topics. Previously, this course only supplied notes and 2 dimensions (2D) drawings only. Take-off is the process by which measurements for construction items are taken from drawings. Based on an observation that has been conducted on Semester Four (4) students of Diploma in Quantity Surveying in Politeknik Kota Bharu, it shows that the students have difficulty in understanding their lessons, especially with the course that requires visual skills. In addition, many students, lack of skill to read, visualize and interpret information while using typical 2D drawings. Therefore, the 3D-BES is developed to overcome the problems encountered.

The context or background of the innovation

An observation by Gazi et. al (2010), found that a group of students that learn in 3D visualization were more excited and wished to stay longer in the session other than the students with 2D visualization. Kim (2012) in his study of BIM, also supported the idea of 3D model to helps students learn the construction details and taking-off works. This innovation named the 3D-BES is a combination of 2D construction drawing layouts and 3D building objects. It was developed by using Floor Plan Creator. Firstly, a building plan complete with a scale, before it was turned into the form of 3D by using Floor Plan Creator. It contains a drawing plan and a 3D model that are related to each other. Later, students need to view the 3D-BES by using the link provided by the lecturer or download the Floor Plan Creator application at the Play Store to open the 3D-BES model. This 3D model can be viewed by using the smartphone, tablet or any digital devices of the students.

The importance of this innovation to education

This innovation is important to the education field because nowadays, many teaching and learning have been implementing online. Due to that, many quantity surveyor students hard to understand their lesson, especially quantity take-off works. The main purpose of this innovation is to help students visualize construction drawing and understand better BWM4 course so that they can take-off the quantity of work correctly. Other than that, the 3D-BES is developed to assist students in understanding real views in taking-off preparation and to produce effective, interesting, and mobile apps which students can access anywhere. Also, it's intent to improve existing teaching techniques. The 3D-BES application allows students to explore the elements of a building (BWIC, electrical and sanitary appliances).

Advantages of the innovation towards education and community

This product can create a more exciting and entertaining learning environment. Also, it can motivate lecturers to produce and apply innovation in a form of technology to make their teaching and learning activities more enjoyable. Likewise, it allows the institution like Polytechnic in offering courses that are competitive in the era of globalization and meet the needs of the industry.

Commercial value in terms of marketability or profitability of the innovation

The 3D-BES also has commercial value in terms of marketability or profitability in development for contractors and stakeholders making new project development. It also prepares students to face the real world of construction industry that uses a lot of technology such as Building Information Modelling (BIM).

References

- Alam, G. M., Oloruntegbe, O. K., Oluwatelure, A. T., Alake, E. M., & Ayeni, A. E. (2010). Is 3D just an addition of 1 to 2 or is it more enhancing than 2D visualizations?. *Scientific Research and Essays*, 5(12), 1536-1539.
- Garmendia, M., Guisasola, J., & Sierra, E. (2007). First-year engineering students' difficulties in visualization and drawing tasks. *European Journal of Engineering Education*, 32(3), 315-323.
- Kim, J. L. (2012). Use of BIM for effective visualization teaching approach in construction education. *Journal of professional issues in engineering education and practice*, 138(3), 214-223.
- Tumkor, S., & de Vries, R. H. (2015), Enhancing Spatial Visualization Skills in Engineering Drawing Courses Paper presented at 2015 ASEE Annual Conference & Exposition, Seattle, Washington. 10.18260/p.24001

MEASUREMENT OF MILITARY COMBAT READINESS USING INTANGIBLE HUMAN DIMENSION FACTORS

S. Inderjit

National Defence University of Malaysia, Kuala Lumpur, Malaysia
inderjit@upnm.edu.my

Hasan Al-Banna Mohamed, Abdul Rahman Abdul Razak Shaik, Safar Yaacob, Ummul Fahri Abdul Rauf, Jessica Ong Hai Liaw, Siti Najwa Zainuddin, Kwong Fook Wen, Wong Wai Loong

National Defence University of Malaysia, Kuala Lumpur, Malaysia
Ministry of Defence, Malaysia, Kuala Lumpur Malaysia

hasanalbanna@upnm.edu.my, abdulrahmansh@upnm.edu.my, safar@upnm.edu.my, ummul@upnm.edu.my, jessica@upnm.edu.my, najwa.zainuddin97@gmail.com, fwkwong2000@yahoo.com, ww16608@yahoo.com

Highlights: Malaysia's military forces including other security agencies lack a model of framework and an assessment instrument as a means of combat readiness to measure individual and collective team preparedness before deploying for any operations including international peacekeeping operations and human disaster relief operations within the country. The current combat preparedness of security agencies is in piece meal assessment working in silos which often create discrepancies and compatibility issues especially when they are required to work in cohesiveness during a combat operation for both local and international duties. A systematic approach of assessment both tangible and intangible for all security forces must be developed to address such issues and challenges especially when required to as very often they are required to join forces in working together in concert with other forces for operations. Using a mixed-method approach the research investigate the factors on the current assessment of combat readiness for most security forces using the human dimension factors prior for combat duties and eventually proposing a systematic model and framework assessment for combat readiness which can be used by all security forces in Malaysia especially when working together in combined and joint operations. The aim of this research is to address the current gap of assessment in security forces and propose a systematic model and developing an assessment instrument to determine the combat readiness for all security forces in Malaysia namely Malaysian Army, Royal Malaysian Air Force, Royal Malaysian Navy, Royal Malaysian Police, Malaysian Maritime Enforcement Agency and other relevant security forces in Malaysia to work in cohesion and provide some distinctive operations procedures as an agency or in teams working together in any operations both local and international duties.

Key words: *intangible human dimension, combat readiness, military*

Introduction

The theories underpinning combat readiness allude to the facts that there are different approaches and variables used for the measure of combat readiness. Measuring combat readiness in an Armed Forces involves the measures of tangible and intangible elements of combat power. However, the mathematical models and formulae used for the measure are focused mainly on either the tangible or the intangible elements. The purpose of this research is to provide an integrative model that provides a comprehensive measure of the combat readiness depicting its status of capability and operability by incorporating the tangible and intangible elements of combat power. Military readiness is one of the component of national power as include in National Power Policy concept (Creswell, 2014). Military combat readiness refers to a military force's ability to meet the demands of its assigned missions or duties. Military combat readiness aims to ensure that the military force is ready and capable of performing missions as assigned. Therefore, it is important to assess the crucial aspects that contribute to military combat readiness.

Meanwhile, soldier, leader, and organisational development and performance are all influenced by the intangible human dimension element, which includes morale, physical, and cognitive factors. This is necessary for raising, preparing, and employing the military in full spectrum operations that are not measured to enhance military readiness parameters (S.Inderjit et al, 2014).

This research will look at some components of intangible factors namely morale, quality of life and military psychological factors. The goal of this study is to fill the current assessment gap in security forces by proposing a systematic framework and designing an assessment tool to identify all security forces' preparedness. This will be accomplished by creating a validated and reliable instrument to assess command readiness, as well as a score spreadsheet to indicate the status of command climate for units namely Malaysian Army, Royal Malaysian Air Force, Royal Malaysian Navy, Royal Malaysian Police, Malaysian Maritime Enforcement Agency and other relevant security forces in Malaysia to work in cohesion and provide some distinctive operations procedures as an agency or in teams working together in any operations both local and international duties.

Research Methodology

The different approaches adopted by different Armed Forces specify different variables which contribute towards the measures of combat readiness. For this research in the Malaysian Armed Forces a Mix method of qualitative and quantitative approach are applied in this research. Based on current doctrines and interviews conducted with current

top management of the Malaysian Army has indicate on current operational and military readiness of Malaysian Army. Furthermore, this research practise previous research on other major militaries around the world, such as the US Army, Australian Army, and Canadian Army to gain a better understanding of the current operational and military readiness assessment framework and model and to determine the best approach and practises they currently applied.

Retrospective Interview Protocols with soldiers on combat duties in the field to determine what variables and factors is evident for combat readiness assessment framework and model to be used in the Malaysian Armed Forces in the future based on current environment, situational awareness and military technologies. Questionnaires aimed at determining the various variables and factors that go into determining the Malaysian Armed Forces military combat readiness assessment framework and model, as well as approaches to operational preparedness for deployment and operational duties. Focus group interviews with selected Senior and Junior Military Officers, Senior Non-Commissioned Officers (SNCOs) and Junior Non-Commissioned Officers (JNCOs)

Product Description

Malaysian Armed Forces currently measures combat readiness for combat deployment through the System Force Scoring (SFS) which quantifies the combat logistics and manpower requirements only. Unfortunately, other factors for combat readiness are not identified such as morale, quality of life and psychological factors. There is a need to look at cognitive and intangible factors to determine whether the individual, unit and organization are ready to be deployed for combat duties and operations. An early model of military readiness from the major military forces in the world suggested that the human components of operational readiness rested on several psychological components, including confidence, proficiency (achieved through training and experience), and understanding of and motivation toward combat missions. There is a need to address the issues of compatibility for other security forces to work together in concert in operations rather than they working in isolation. At such this research is proposing a systematic assessment framework and model to measure military readiness which can be used by all security forces in Malaysia especially when working together in combined and joint operations for both local and international duties.

Importance of Research

The main objective of developing the nation's defence capability is to build an MAF that is integrated and balanced with the combination of assets and other resources for the purpose of national defence. This principle emphasizes combat readiness and operational preparedness in the Armed Forces structure as it involves not only combat forces but also the logistical support network of military-industrial cooperation in line with national development priorities. In this context, self-reliance should not be limited to military efforts alone but should involve all relevant government agencies and the people. All security agencies besides the military are relevant for the prosperity and stability of the country and to the people of Malaysia. This instrument will also take preventive measures and also corrective measures after establishing the score of an individual, unit and an organization. The outcome of this research is to develop a systematic model and framework assessment for combat readiness for all Malaysian Security agencies. This instrument that will be able to measure the combat readiness both tangible and intangible factors of units to be deployed in combat areas, humanitarian assistance such as natural disaster assistance, peacekeeping operations such as the current military deployment in Lebanon and national security operations such as the recent intrusion in Lahad Datu in 2013.

The importance of conducting this research is to maintain strategic importance of environment of a stable and secure for people and country in align with National Defence Security Policy that strive to enhance national defence and Armed forces modernization (National Defence Policy, 2014). Furthermore, it is important to build an integrated and balanced with the combination of assets and other resources for Malaysia Armed Forces (MAF) to enhance nation security. Moreover, developing assessment model that can be applied to all security forces which will allow them to prepare for any operational duties effectively.

Advantages of the Product

This research address the current gap of assessment in security forces and propose a systematic model and developing an assessment instrument to determine the combat readiness for all security forces in Malaysia namely Malaysian Army, Royal Malaysian Air Force, Royal Malaysian Navy, Royal Malaysian Police, Malaysian Maritime Enforcement Agency and other relevant security forces in Malaysia to work in cohesion and provide some distinctive operations procedures as an agency or in teams working together in any operations both local and international duties.

Commercial Value

The patent for this research will be of significance and relevant for security forces in Malaysia namely Malaysian Army, Royal Malaysian Air Force, Royal Malaysian Navy, Royal Malaysian Police, Malaysian Maritime Enforcement Agency, and other relevant security forces.

Acknowledgement

The Ministry of Education (MOE) has funded this study under the Fundamental Research Grant Scheme (FRGS/1/2019/SS03/UPNM/02/2). Also, an utmost appreciation to National Defence University of Malaysia (NDUM) for granting the chance for this research.

References

- Inderjit, S., Ananthan, S., ZS, N., & Kwong, F. W. (2014). THE SYNCHRONIZATION OF HUMAN DIMENSION FACTORS IN DETERMINING MILITARY COMMAND CLIMATE. *European Journal of Educational Sciences*, 01(03). <https://doi.org/10.19044/ejes.v1no3a8>
- Kwong, F.W., Nor, N.M. & Lee, L.S. (2013). A Survey on the measure of combat readiness. *Statistics and Operation Research 2013 Records of Proceeding*. Citation: AIP Conference Proceedings 1613, 3 (2014); doi: 10.1063/1.4894326
- Kwong, F.W., Nor, M.N., Jegak Uli & Inderjit Singh Tara Singh. (2014). Conceptualising the measure of combat readiness by incorporating the tangible and intangible elements of combat power. *6th International Conference on Humanities and Social Sciences Conference Proceeding*. Zulfaqar Int. J. Polit. Def. Secur. 1(2).
- Kwong, F.W. (2015). Integrative model of the tangible and intangible elements of combat power for the Malaysian Army combat readiness. *National Defence University of Malaysia, Kuala Lumpur, Malaysia*. Creswell, Research Design. California: Sage Publication Inc., 2014, p.117.
- Malaysian National Defence Policy, 2014
- The Importance of Military Readiness: IDB. Institute for Defense & Business. (2021, February 25). <https://www.idb.org/the-importance-of-military-readiness/>.

SMART 3-WHEEL BIKE “EMPOWER DISABLED ENTREPRENEURS WITH TECHNOLOGY”

Nurnaddia Nordin

Universiti Malaysia Kelantan, Kota Bharu, Kelantan
naddia.n@umk.edu.my

Nurhaiza Nordin

Universiti Malaysia Kelantan, Kota Bharu, Kelantan
haiza@umk.edu.my, haiza@umk.edu.my

Highlights: Technology is a crucial factor for starting a business today and it is an important factor for disabled entrepreneurs. Entrepreneurship has become one of the preferred fields of employment for disabled people due to lack of other employment opportunities. However, the existing technology for disabled people is still insufficient to ensure that disabled people remain competitive in the entrepreneurship field. The Smart 3-Wheel Bike was developed with the aim of providing better facilities to entrepreneurs with disabilities. The process of developing this product is based on three phases, analysis phase, design and development phase and finally implementation and evaluation phase.

Key words: *Disable people, entrepreneurship, technology*

Introduction

The opportunity for disabled people to be employed is lowered compared to the normal people. One of the main reasons is lack of the employability skills. Disabled people experience lower labour market participation rates than the non-disabled (Grammenos 2011). Statistics shows that only 0.31% disabled person were employed from 68.7% total labour participation rate in 2019 and become lowest because of the Pandemic Covid-19 outbreak. This figures shows that, disabled people tend to be concentrated in lower-skilled, lower-paid occupations (Meager and Higgins 2011). One possible solution to problems of low participation rates lies in the potential for disabled people is to become self-employed or to start and run their own businesses. Promoting entrepreneurship constitutes an important part of national agenda. The 'National Entrepreneurship Policy' (DKN) was introduced as a guide to provide a holistic framework or ecosystem for the development of entrepreneurship in Malaysia, which today is seen to be growing rapidly. This is in line with OKU Action Plan 2016-2022, entrepreneurship is made the strategic thrust in empowering the economy of the OKU, through increasing the participation of the OKU in the open, inclusive and accessible job market to enable them to live independently and contribute to national development. Disabled people are often disadvantaged to handle a complex situation like business. The task is much more difficult for disabled people and in some cases even impossible compared to normal people. Due to their disability they need (e.g. technology) which help them to grow the business. Either disabled people or non-disabled people, technology is an important factor to achieve and maintain self-motivation and self-esteem and to participate in social environment (Sans-Bobi, M. A. et al. 2012, Rozell et.al. (2010) and Norasmah (2002) and Rogoff et al (2004). Smart 3-Wheel bike was developed with the aim of making business easier for disabled people and to vanquish barriers to organize their business in a competitive manner.

Product Design:

Smart 3-Wheel is designed using a modified motorcycle where it will be equipped with reverse gear transmission facilities, large basket/place to place the sales items, roofed and equipped with safety features. As compared to the available supporting facilities for disabled people, Smart 3-Wheel Bike is more user friendly.

Prototype Specifications
Height: 66 inches (168cm)
Width: 42 inches (110 cm)
Length: 102 inches (260cm)

Basket size:
Length: 52 inches (132 cm)
Width: 42 inches (107cm)

Product development:

This product is a collaboration project between UMK and Deen Ironwork that fully funded by UMK Prototype Research Grant (UMK-Pro). In December 2020, the process of analysis, design and development has been started and currently achieved 85% of development progress.

CARNIVAL OF RESEARCH AND INNOVATION (CRI2021)

In conjunction with International Virtual Innovation & Invention Challenge
(INTELLIGENT2021) & Creative Innovation Carnival (CIC2021)

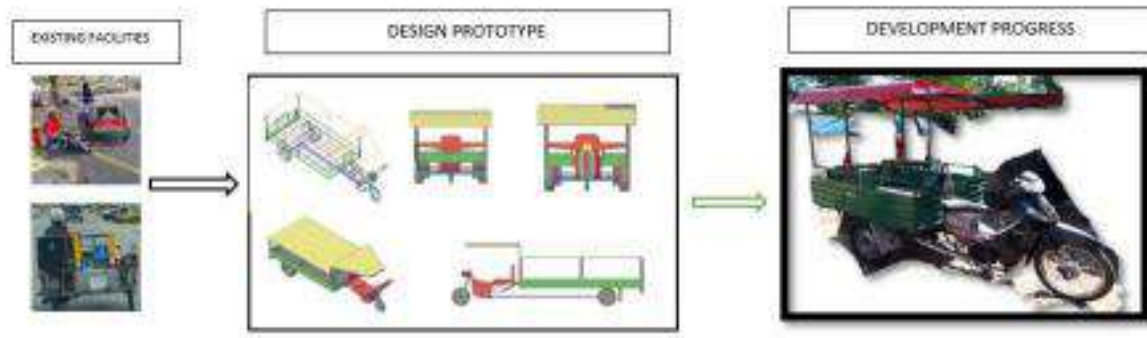

Process

There are three phases of the product development. First is the analysis phase, where it is to identify and solve problems. In this phase, researchers clarify the problem, identify the source of the problem, and determine the solution of the problem. Among the aspects that will be evaluated in the analysis phase are: Analysis, Evaluation, Development, Implementation, and Design. The second phase is design and development. The design phase aims to plan strategies in product development. Among the appropriate elements available in the design phase are: Formation of specific objectives, Construction of items for testing, and Approach will be used. Then followed by the development phase. The development phase is the phase for developing a prototype. In this phase, product development will be developed in stages. This development phase is built based on the analysis and design phase. The last phase is the Implementation phase. The implementation phase is the phase to determine the level of effectiveness and problems that may occur in the design and development phase. The improvement process will be carried out in this phase to achieve the objectives outlined.

Importance of Product

Smart 3-Wheel Bike will be able to facilitate disabled people in doing business and growing their business. In most cases, due to inappropriate technologies, people with disabilities have disadvantages to obtain independent individuality as well as necessary information for their business and to overcome barriers in order to organize their business in a competitive manner. Thus, in order to strengthen the entrepreneurship of disabled people, it is therefore essential to provide technology support to them.

Advantages

1. Able to facilitate disabled people to operate the vehicle easily because it is equipped with reverse gear transmission.
2. The vehicle has larger storage space.
3. The vehicle is equipped with a roof.
4. The design and size are ideal.
5. Equipped with safety features.

Marketability

Smart 3-wheel Bike design to fulfill the need for disabled people. Besides, this product is seen to be able to meet demand other than the disabled people, where it can be used in the small-scale agricultural sector (such as palm oil farmers, rubber, vegetables).

Acknowledgement

Universiti Malaysia Kelantan, UMK Prototype Research Grant (UMK-PRO)

References

- Grammenos, S. (2011) Indicators of Disability Equality in Europe: ANED 2011 Task 4: Update And Extend The Piloting Of Quantitative Implementation Indicators; Comparative Data On A 23 Selection Of Quantitative Implementation Indicators, online at: <http://disabilityeurope.net/theme/data-and-indicators>
- Meager, N., & Higgins, T. (2011). Disability and skills in a changing economy. UK Commission for Employment and Skills, Briefing Paper Series.
- Sans-Bobi, M. A., Contreras, D., Sánchez, Á. (2012). Multi-Agent Systems orientated to assist with daily activities in the homes of elderly and disabled people. In: Zaccarias, M., De Oliveira, J. V. (Eds.). Human-Computer Interaction: The agency perspective, p. 145.
- Norasimah Othman. 2002. Keberkesanan Program Keusahawanan Remaja Di Sekolah Menengah. Disertasi Ph.D, Universiti Putra Malaysia, Serdang.
- Rogoff E. G, Lee M, & Suh D. (2004). Who Done It? Attributions by Entrepreneurs and Experts of the Factors That Causes and Impede of Small Business Success. *Journal of Small Business Management* 42 (4): 364-376.
- Rozell, E.J., Scroggins, W.A., Amorós, J.E., Arteaga, M.E. & Schlemm, M.M. 2010. Entrepreneurship in specific cultural contexts: the role of training and development for entrepreneur-culture fit. *Journal for Global Business Education*.

PUBLIC MOBILITY MONITORING USING COMPUTER VISION AND GIS FOR MEASURING PANDEMIC SOCIAL DISTANCING IN EFFECTIVE AND SCALABLE MANNER

Arham Muchtar Achmad Bahar

UMK Jeli Campus, Kelantan, Malaysia
arham@umk.edu.my

Wani Sofia Udin

UMK Jeli Campus, Kelantan, Malaysia
wanisofia@umk.edu.my

Highlights: In a widespread pandemic like COVID-19, social distancing action needs to be encouraged and tools to scalable monitor this action is highly needed. This centred tool will be much more powerful to monitor at thousands sites and reduce a lot of man-power to make the monitoring process much more effective and scalable. The method to do this is by using public CCTV sources, both computer vision and GIS technology can be leveraged to capture, process and reflect what happened in multiple areas and take preventive measures if needed.

Key words: Covid -19, social distance, monitoring, computer vision, GIS, technology

Introduction

In a widespread pandemic that can transmit from human to human, social distancing norms will be encouraged; people will be encouraged to be socially distanced from each other. This can happen in many areas including office area, commercial area, public facility area, and more. With this regulation, monitoring and preventive actions (like dissolution by police or military officer) will be needed to prevent crowd which will worsen the spread out of the pandemic itself. While we can use a lot of security officers to monitor, by using human to monitor the crowd create another problem, the officers itself can be contracting the disease or even transmitting the disease itself to the crowd.

The solution is by creating a non-invasive (not by using humans itself) public monitoring tool that is effective and scalable to alert officers so that preventive actions can be taken. The tool itself sits on the online cloud application and takes frames of pictures within video streaming, these frames will be processed and analyzed using computer vision (deep learning, artificial intelligence) technology to calculate the amount of vehicle and person within a single frame. Then, based on metadata that is included on each CCTV (geographic location, latitude and longitude), GIS visualization can be created to reflect in which region that has a highest number of vehicles or people. Alerting will be provided based on the spike of data to alert responsible officers so they can disperse the monitored crowd.

Content

Will a GIS-based tool can be utilized to monitor public crowds to cope with widespread pandemic?

GIS serves as a common platform for standardized surveillance and monitoring of indicators from different areas (e.g., georeferencing of epidemiological data). Using this common platform, health organizations generate maps showing case distribution at multiple scales (e.g., world, country, regional, provincial, and district levels) and predict which populations are most vulnerable based on their proximity to risks. This research focuses on identifying which model efficiently runs on constrained computation platforms such as a mobile device and building usable software to aid GIS research.

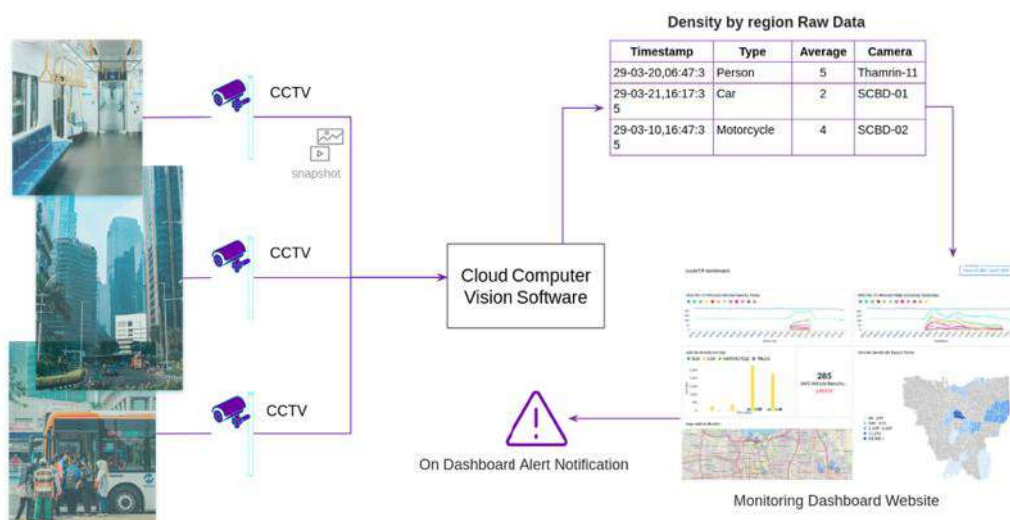

Computer Vision Process

This step will input data sources from multiple publicly available CCTV, the software on cloud will scrap the data using video streaming software frame-by-frame and location of metadata will be provided. By using computer vision software that utilize artificial intelligence and deep learning, the software will analyze the number of vehicles (vehicle detections) and the number of people (person detections) of each frame to calculate the density of vehicles or people in specific regions. Using state-of-the-art object detection pretrained model that is currently available (e.g. YOLO object detection model).

When an outbreak is detected and public health personnel go into the field for additional investigation, GIS strengthens local data collection, management, and analysis. The data will be dumped on a time-series keyed database that can hold a massive amount of data (e.g. Google BigQuery). This stored data in the database will include detections of the computer vision process and location (city, region, latitude, longitude) metadata from data acquisition.

In terms of situational awareness, GIS is the core of many situational awareness systems. Situational awareness systems aggregate data from many sources into map-based interfaces that promote better understanding. For example, such systems enable forecast the short-term and long-term impact of events and implement interventions such as quarantine and isolation.

Alerting benefits. Software will be alerting (by phone or SMS) automatically (integration through available phone or SMS automatic communication) and also standard component of mass notification systems alert to responsible officers to disperse the public crowd

References

- Colizza V, Barrat A, Barthelemy M, Valleron AJ, Vespignani A. 2007. Modeling the worldwide spread of pandemic influenza: baseline case and containment interventions. *PLoS Med.* 2007 Jan;4(1):e13. doi: 10.1371/journal.pmed.0040013. PMID: 17253899; PMCID: PMC1779816.
- Esri. Health and Human Services Tracks Stockpile Shipments on the Web. *ArcNews*, Fall 2006. Available at esri.com/news/arcnews/fall06/articles/health-and-human.html.
- Ivan Franch-Pardo, Brian M. Napoletano, Fernando Rosete-Verges, Lawal Billa. 2020. Spatial analysis and GIS in the study of COVID-19. A review, *Science of The Total Environment*, Volume 739.
- Nasajpour, M., Pouriye, S., Parizi, R.M. 2020. Internet of Things for Current COVID-19 and Future Pandemics: an Exploratory Study. *J Healthc Inform Res* 4, 325–364 (2020). <https://doi.org/10.1007/s41666-020-00080-6>
- Ohkusa, Y. 2008. Application of an Individual Based Model with Real Data of Transportation Mode and Location to Pandemic. Presented at the 2008 Esri Health GIS Conference. Available at proceedings.esri.com/library/userconf/health08/docs/tuesday/pandemic_simulation.pdf.
- Ramsey, S. 2008. Using GIS to Streamline Public Health Response. Presented at the Esri 2008 Health GIS Conference. Available at proceedings.esri.com/library/userconf/health08/docs/tuesday/streamline_public_health.pdf.

BOOKTABLELA APPLICATION

Navanitha Moorthy

University Teknologi PETRONAS
32610, Seri Iskandar, Perak, Malaysia
navanitha_25046@utp.edu.my

K.S. Savita

Department of Computer and Information Sciences (DCIS)
Faculty of Science and Information Technology (FSIT)
32610 Seri Iskandar, Perak Darul Ridzuan, Malaysia
savitasugathan@utp.edu.my

Highlights: BookTableLa is a mobile application to help people escape crowded areas, particularly in the restaurant, and to save time by displaying the percentage of people inside the restaurant. The customer can even book a table before dining-in food shops. Besides, the owner of the restaurant may also advertise their services through this application. The desired system was carefully designed and developed after receiving all the specifications and input from the users. The entire system was built on the Flutter framework. The restaurant owners and customers are the primary stakeholders in this application.

Key words: *Booking system, Booking table, GPS, COVID-19, customer management system, restaurant*

Introduction

The world is now facing a dangerous virus infection caused by severe serious respiratory syndrome with coronavirus. Several factors give caused a rise in the number of cases(Shah et al., 2020). Comprehensive and persistent strains of this epidemic have become a significant concern in Malaysia. To defeat pandemic, Malaysia government implement Movement Control Order (MCO) to keep spread and mortality under control. During this time, the society in Malaysia allowed to public places as long as complying with a few regulations. These guidelines require social space, wearing face masks, and avoiding busy areas(Chan, D., 2020). Customers prefer to visit to food outlets at the most active hours of the day, such as lunch and dinner. These creating multiple queues in a location which is against the SOP followed by restaurant. This leads four arising concerns:

1. How to monitor the safety during dine-in at restaurants?
2. How to supervise the long queueing in front of the restaurant?
3. How to find the customers' current practices out there?
4. What is the existing application to addresses these challenges?

The application is created on the Flutter framework with the help of certain tools, utilising Agile process. For a period of two weeks, the user requirements are gathered using a poll on Facebook and a Google form. In addition, interviews with two restaurant owners and 60 customers are done. The user interface is designed to meet the criteria of ease to use, usable and attractive most of the user interface was built into it to make it more convenient, attractive, and user-friendly that is suitable for all ages. The primary stakeholders of this application are the restaurant owners and their customers. These mobile applications have 2 functions.

The proprietors of restaurants will also be included in the application. The restaurant owner will upload a photo of their establishment or background details as well as restaurant summary when they sign up for the app. They can also upload a photo of their regular or special menu to the application. They can also look at a list of customers booking tables in the booking tab. Once a customer has left the restaurant or has not arrived after one hour, the restaurant owner has the ability to adjust the booking status so that other customers have a chance to book tables in their restaurant.

Customers who register for this system must click allow and enable the Global Positioning System (GPS) feature on their phone. The reason for this is that the customer can access a list of restaurants by entering their current location in the restaurant tab. As they browse the list of restaurants, they can click on a specific restaurant to learn more about it, such as its success or the type of menu it serves. Customers can book a table by clicking on the booking button in the same tab.



Figure 1: Few UI of BookTableLa application

There are existing applications available the market, however their applications have its own limitations. Some of the limitations for TABLEAPP are all restaurants are high class restaurant, difficulty to search nearest locations ,less user-friendly and difficulty in log in and sign up. BookTableLa application has addressed those limitations by offering these features all types of restaurants can register, easy to search by location, user-friendly and easy to log in or sign up.

The Malaysian has the culture of eating outside. Despite, there was serious outbreak, and the society still would like to have meal at restaurant once a week. As a result, people will eat at restaurants or other food outlets whenever they want, regardless of the time of day. Most people visit food outlets at peak hours of the day. The resulting in enormous crowds in certain locations. So, to control a large amount of people, the restaurant should have a system to manage their customer during peak hours. By having this application, restaurant owners can control the crowd inside the restaurant as customers can now view the availability of a place and make a smarter choice. At the same time, customers also can save their time by using this table booking system.

The goal of the BookTableLa application is to raise awareness of SOPs at all levels, particularly among those who dismiss the Covid-19 Pandemic outbreak, and some of whom may be unaware of the human implications. This type of knowledge is useful not just for eateries, but also for school pupils and university students who are learning how to obey the government's SOPs. The society will also learn to use apps to help with daily tasks.

The benefit of using BookTableLa application creating awareness on how to follow SOPs and learning on how to utilize applications to assist with their daily routine. Customers feel safe dining in at a restaurant because the eateries adhere to the government's SOPs. Make use of a reservation system prior to dining. Restaurant will use little paper, so an environmental-friendly space created. Restaurant utilizes a table reservation system; they are able to develop well in terms of their profitability as the number of customers who will be dining in at the restaurant can be increased.

Acknowledgement

The authors are grateful to the university administration (UTP) for their support, as well as funding under YUTP (No: 015LC0-122). We would like to express our appreciation to the anonymous judges and reviewers for their constructive feedback.

References

- Chan, D. (2020, May 4). Eateries ready for dine-in customers. NST Online.
<https://www.nst.com.my/news/nation/2020/05/589684/eateries-readydinecustomers>
- Shah, A. U. M., Safri, S. N. A., Thevadas, R., Noordin, N. K., Rahman, A. A., Sekawi, Z., Ideris, A., & Sultan, M. T. H. (2020). COVID-19 outbreak in Malaysia: Actions taken by the Malaysian government. *International Journal of Infectious Diseases*, 97, 108–116.

SMART FERTILIZATION MANAGEMENT FOR OIL PALM TREE BASED ON IOT AND DEEP LEARNING

Shaparas Daliman

Faculty of Earth Science, Universiti Malaysia Kelantan Jeli Campus, 17600 Jeli, Kelantan, Malaysia
shaparas@umk.edu.my

**Nur Ain Najwa Mohd Adib¹, Nazahatul Anis Amaludin¹, Noor Janatun Naim Jemali¹, Aweng Eh Rak¹,
Nordiana Abd Aziz²**

¹Faculty of Earth Science, Universiti Malaysia Kelantan Jeli Campus, 17600 Jeli, Kelantan, Malaysia

²Malaysian Palm Oil Board (MPOB), 6, Persiaran Institusi, Bandar Baru Bangi, 43000 Kajang, Selangor, Malaysia
[ainnn19@gmail.com](mailto:aিন্ন19@gmail.com), nazanis@umk.edu.my, janatunnaim@umk.edu.my, aweng@umk.edu.my, nordiana@mpob.gov.my

Highlights: With the adaptability of Internet of Things technologies, oil palm tree growth data and fertilization management can be utilizing effortlessly and effectively. The context of conceptual framework comprises the IoT technologies, image processing, machine learning and deep learning which focuses on environmental factors that affecting the oil palm tree growth that involve temperature, humidity, soil moisture content, light and nutrient will be analysed. Thus, a prototype framework of IoT and deep learning for smart fertilization management of oil palm trees is suggested will be beneficial in helping and raise the efficiency of oil palm trees management in Malaysia.

Key words: *fertilization management, deep learning, IoT, oil palm tree.*

Introduction

Oil palm trees contribute economic income to the national and community by generating various types of productions. This will cause an expansion of the area for the plantation of oil palm seeds, then contributes to the stability in distributing good quality oil to accommodate the growing population. Furthermore, degradation occurs when the planting of oil palm trees increases rapidly, especially the occurrence of uncontrolled oil palm cultivation. The degradation can cause loss of soil nutrients due to soil erosion. The lack of macronutrients, Nitrogen (N), Phosphorus (P), Potassium (K) and Magnesium (Mg) on oil palm tree may impact on its growth which includes the quality of crops. Traditional approach to detect macronutrients, can also lead to some improper control in turn leads results in reduction in yield. The existing system has given limited information of dataset and slower classification performance due to limited functions. The development of an uncomplicated, simpler, and affordable method is needed for analyzing the growth of palm oil trees. In oil palm plantation contain nutrient deficiencies either Potassium (K) deficiency, Magnesium (Mg) deficiency, or Nitrogen (N) deficiency, hence these nutrients can be identified using image of oil palm leaf (Culman et. al, 2017). This innovation project combines IoT and image processing to monitor palm oil tree health status and to collect the physical factors that affect plant growth. This is part of an essential criteria in promoting sustainable oil palm tree plantation management using IoT application and deep learning architecture among community in Malaysia so as to sustain the quality of palm oil for the long term.

Content

The system of an IoT comprising the sensors and devices that connect to the database via several types of connectivity. It begins when the sensors and camera module gather the information. The information will be delivered by the sensors to Arduino device that acts as the sensor node. Next, the Arduino device sends the information through serial communication or I2C communication to Raspberry Pi that acts as gateway. Raspberry Pi will be converting the information into comprehensible digital values and store the information for a while. The Raspberry Pi performs the large amount of processing data while Arduino utilizes when the small amount of processing data is needed. When the Raspberry Pi senses an acceptable wireless network or the Internet, Raspberry Pi will be sending the locally stored data to a Firebase platform. The information will be monitoring in real-time database as well as it will be processed, analyzed, stored and promoted to the end-user devices, display by an application software. Image data will be undergoing image processing for further analysis of nutrient deficiencies of oil palm trees.

IoT-based processing images and data of the oil palm tree will be capturing for the research project. IoT camera module will capture the images in RGB form of the oil palm plant. The prototype of smart fertilization management will be tested on three broad treatments of oil palm tree. There are three treatments where the first treatment, oil palm trees get adequate fertilizer, while the second treatment, oil palm trees are given insufficient fertilizer and fertilizer will not be given to oil palm trees for the last treatment. This research will produce new techniques in deep learning and pattern recognition based on IoT-based processing images. The results from this research would be a high accuracy accomplishment in oil palm industry especially in developing in a nutrient deficiencies detection and better oil palm tree management. By implementing the smart fertilization management based on IoT and deep learning, it will be an advantage for the oil palm industry in overcoming inefficient management of oil palm plantation which may assist the government policy.

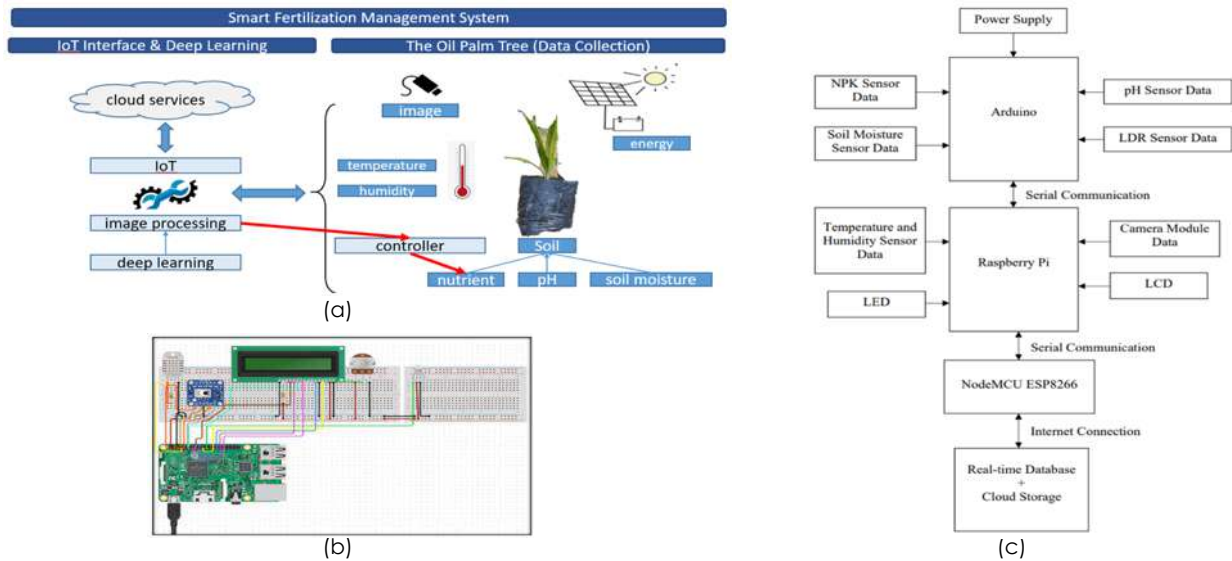

Figure 1: (a) Conceptual framework, (b) IoT circuit design system and (c) block diagram of IoT for smart fertilization management of oil palm tree

This innovation project performs to detect nutrient deficiency of young oil palm trees under several experiment treatments. The outcomes of this study will provide benefit of society considering that IoT technologies will provide a better and well-managed data collection. The collected and processing data are store in a real-time database and cloud storage. This gives a better visualization of data to targeted users such as traditional and modern farmers, and academy researchers through graphs in real-time database. For the farmers and researchers, smart monitoring will help them in contributing valid data by comparing the image processing data with the ground truth data, reduce workload because can be monitoring remotely such as using drone as in Hashim et. al.. (2020), and uncover critical areas in study that many researchers were not able to explore. Thus, it will develop a new theory on using IoT technologies. Smart monitoring using IoT technologies will assist farmers and growers balancing prescriptions of fertilizer or discovering crop diseases before it become spreading. The valid data collection will help in economic and environmental savings. This is very important for the purpose of strengthening knowledge on related oil palm plantation communities and industries in Malaysia and will directly improve the standard of living and income for an oil palm crop community and industry.

Conclusion

The development of smart fertilization management for oil palm tree based on IoT and deep learning is still on-going. This innovation project can be as a part of a solution for managing the oil palm plantation. Furthermore, this method will be reducing the utilization of fertilizers which can creates environmental pollutions. This system may assist and increases the efficiency of oil palm plantation management in Malaysia.

Acknowledgment

Authors would like to express appreciation to the members of Faculty of Earth Science, UMK and Malaysian Palm Oil Board (MPOB) as collaborating partner for their support and valuable comments and ideas. Authors also acknowledge the Universiti Malaysia Kelantan (UMK) (through UMK-PRO research grant R/PRO/A0800/01595A/003/2020/00873) for providing financial support to undertake this research and innovation strategy.

References

- Culman, M. A., Gomez, J. A., Talavera, J., Quiroz, L. A., Tobon, L. E., Aranda, J. M., Garreta, L. E., & Bayona, C. J. (2017). A Novel Application for Identification of Nutrient Deficiencies in Oil Palm Using the Internet of Things. 2017 5th IEEE International Conference on Mobile Cloud Computing, Services, and Engineering (MobileCloud), October, 169–172.
- Muhammad Asraf, H., Tahir, N. M., Nur Dalila, K. A., & Hussain, A. (2018). An Agricultural Tele-monitoring Method in Detecting Nutrient Deficiencies of Oil Palm Leaf. International Journal of Engineering and Technology (UAE), 7(4),
- Daliman S, Abu Bakar S A R and Md Nor Azam S H 2016 IOP Conference Series: Earth and Environmental Science Development of Young Oil Palm Tree Recognition Using Haar-Based Rectangular Windows
- Hashim S A, Daliman S, Md Rodi I N, Abd Aziz N, Amaludin N A and Eh Rak A (2020) Analysis of Oil Palm Tree Recognition using Drone-Based Remote Sensing Images, IOP Conference Series: Earth and Environmental Science, Volume 596, International Conference On Science And Technology 2020, September 2020, Malaysia
- TongKe, F. (2013). Smart Agriculture Based on Cloud Computing and IoT. Journal of Convergence Information Technology, 8(2), 210–216. <https://doi.org/10.4156/jcit.vol8.issue2.26>
- Kamilaris, A., Gao, F., Prenafeta-Boldu, F. X., & Ali, M. I. (2016). Agri-IoT: A Semantic Framework for Internet of Things-enabled Smart Farming Applications. 2016 IEEE 3rd World Forum on Internet of Things (WF-IoT), 442–447. <https://doi.org/10.1109/WF-IoT.2016.7845467>
- Hashim S. A., Daliman S., Md Rodi I. N., Abd Aziz N., Amaludin N. A. & Eh Rak A. (2020) Analysis of Oil Palm Tree Recognition using Drone-Based Remote Sensing Images IOP Conference Series: Earth and Environmental Science 596 International Conference On Science And Technology 2020 Malaysia.

DEVELOPMENT OF INTEGRATED SCHEDULED WASTE MANAGEMENT SYSTEM FOREducational SECTOR

Norhidayu Noruddin

Centre for Management of Environment, Occupational Safety and Health (CMeOSH), UMK, Malaysia
hidayu.n@umk.edu.my

Ahmad Rasdan Ismail¹, Noor Syuhadah Subki¹, Mohd Khalid Ab Kadir @ Musa¹, Asma Salsabila Che Shaffie¹, Mohamad Fazli Muhamad @ Che Abas¹, Wan Azlee Wan Abdullah², Siti Suhaila Mohd Naw²

¹Centre for Management of Environment, Occupational Safety and Health (CMeOSH), UMK, Malaysia

²Centre for Computing and Informatics, (CCI), UMK, Malaysia

rasdan@umk.edu.my, azlee@umk.edu.my, syuhadah@umk.edu.my, suhaila.mn@umk.edu.my, khalid.ak@umk.edu.my, asma.cs@umk.edu.my, fazli.ca@umk.edu.my

Highlights: Development of integrated system for Scheduled Waste (SW) Management in UMK known as UMK Scheduled Waste System (UMK - SWS) will lead UMK towards the holistics SW management system. The UMK - SWS system is the only SW management system of its kind available in education sector in Malaysia that significantly sustaining the environment as well as complied under the Environmental Quality (Scheduled Waste) Regulations 2005 enforced by Department of Environment, Malaysia.

Key words: *scheduled waste (SW), integrated system, compliance, environment, act*

Introduction

The Department of Environment (DOE) Malaysia had enforced proper scheduled waste management through the Environmental Quality (Scheduled Waste) Regulations 2005 by having Electronic Scheduled Waste Information System (eSWIS). However, the enforced system (eSWIS) of DOE is having many limitations on holistic monitoring of SW through the workplace. Therefore, through the Development of Integrated System for SW Management in UMK known as UMK Scheduled Waste System (UMK - SWS), it will lead UMK towards systematic and efficient SW management with th real time statistically monitored system for SW for all faculty/PTj in UMK.

Content

UMK had initiated the UMK SWS after having a competent person person registered under the act. With the fully top down commitment from UMK top management and every Faculties/PTj within three different campuses in UMK, all SW data was retrieved and compiled. With the start up funding provided by RiMC UMK the real time SW data management system was developed in order to established the real time monitoring capabilities of SW.

There are very lacks of SW management related to the inadequate awareness, lack of competent staff, inefficient practices such as non availability of SW data that contributed as the major problems to the Education Sectors in Malaysia as well as the non-compliance issues under the Environmental Quality (Scheduled Waste) Regulations 2005 enforced by the Department of Environment (DOE), Malaysia.

Past studies revealed that there was lack of SW management control among government sector especially at educational sectors especially in Malaysia Thus UMK will be the first academic institution in Malaysia taken steps ahead in spearheading the intergrated monitoring system of scheduled waste management in order to ensure the sustainability of environment.

UMK- SWS had complied under Environmental Quality (Scheduled Waste) Regulations 2005, Department of Environment Malaysia and can be managed effectively through real time monitoring on the overall SW generation, handling, storage and disposal throughout all faculty/PTj in UMK. UMK-SWS had been registered for trademark for UMK-SWS and copyright for the system develop under Intellectual Property Corporation Of Malaysia (MyIPO). As the only SW Management System of its kind in Malaysia.

Acknowledgement

The researchers would like to acknowledge the financial and support from the RMIC UMK and UMK SW Task Force Members from CMeOSH, CCI, 3PI, FSB, FIAT, FBKT, FIKW, FPV and PKU.

References

Department of Environment Malaysia, (2014). Guidelines of Packaging, Labelling and Storage of Scheduled Wastes in Malaysia. Legal Research Board. (2019). Environmental Quality Act 1974 (127 Act), Rules, Regulation and Orders, International Law Book

ISLAMIC HFitTracker: ISLAMIC HEALTH AND FITNESS TRACKER MOBILE APPLICATION FOR HEALTHY LIFESTYLES

Mohd Fadil Mohd Yusof

Faculty of Hospitality, Tourism and Wellness, Universiti Malaysia Kelantan, Malaysia
fadil@umk.edu.my

Siti Salina Saidin, Nurul Hafizah Mohd Yasin, Siti Fatimah Ab. Ghaffar, Nur Farihin Abd Hadi Khan

Faculty of Hospitality, Tourism and Wellness, Universiti Malaysia Kelantan, Malaysia
salina.s@umk.edu.my, hafizah.my@umk.edu.my, fatimah.g@umk.edu.my, farihin.ah@umk.edu.my

Highlights: The need for digital smart health application to monitor individual health, fitness and spiritual level is one of the potential innovations to be proposed. In this app, person medical records are shared among public health institutions and the records are accessible upon approval from the users. In the case of emergency, the person records are readily accessible through their smart phone with all the details. With such details, medical doctors are able to provide efficient and relevant treatment to the patients. The app may also provide information on the health tips and prevention, the do's and the don'ts in keeping up a healthy lifestyle in accordance to the practice of Islamic traditions.

Key words: digital health, application, mobile health, health prevention, Islamic healthy lifestyles, digital literacy

Introduction

The advance of information and communication technologies has changed the landscape of our society nowadays. The access to the internet and digital devices particularly mobile phones is also increasing rapidly. The internet and digital device are tools that are commonly used in a personal and professional activities performed by individuals. Based on the report by Statista (Johnson, 2021), there were 4.66 billions of active internet users worldwide representing almost 60 percent of global population. Around 93 percent (4.32 billion) of the internet users are accessing the internet using their mobile devices. In Malaysia, the percentage of households having access to the internet is reported at almost 99 percent (Bernama, 2021). The access to the mobile phones and computers also reported at the same rate of 99 percent. As reported by Chief Statistian, Uzir Mahidin, Malaysians are using the internet mostly or social networks. It is also reported that there is an increasing trend for Malaysians to search for information related to education and demand for e-health, e-government and entertainment (Koh, 2020). Against this background, the target users for this app will be middle class society and above who can access to the internet and mobile app. Market will be segmented by age profile such as young, middle age and senior citizens.

Product Description

Based on this interesting trend, it is expected that the demand for both digital health services and fitness tracker is promising. As such, an integrated mobile app is proposed, with added value of Islamic lifestyle content. The app is to cater not only general health-conscious users but especially users who belong in the Muslim community. The application will help both community segments to track personal healthy routine in an Islamic way, mainly to follow the Prophet Mohammed SAW's example to mankind, up to His traditions in health matters.

The Islamic Health and Fitness tracker mobile app primarily contain features such as self-assessment of personal health and fitness, along with advices related to a healthy lifestyle that follow the sunnah of the Prophet Muhammad SAW. The app is expected to be handy for users to note down and record their health information in the log. Therefore, this mobile app is a great medium for health and fitness conscious community, whether the users are interested in learning Islamic health, fitness and dietary tips, or searching for a practical mobile log of their health record. The app is expected to be developed using app development software and can be run on both android and iOS devices. "Everything good that happens to you (O Man) is from God; everything bad that happens to you is from your own actions". (Quran 4:79).

The Islamic Health and Fitness tracker mobile app is proposed to have the following components:

1. Users' self-completion of demographic information and other details related to medical and medication records such as previous diagnoses, vital signs, medications currently taken, immunisation dates, allergies and other relevant reports.
2. Other than health records, the app also may provide suggestions of indoor or outdoor fitness activities which tailored to a specific user's age and demographics.
3. Food and nutritional intake advices, as well as Sunnah diets as practiced by the Prophet Muhammad saw.
4. Sharing of prayers related to health, based on authentic hadiths.
5. Interactive medium for information sharing to selected social media networks permissible by users

A password will be assigned to registered users, in order to access the application. However, not all components are free to be accessed. Certain features are available upon subscription and to be renewed on yearly basis. The information provided in the app is strictly confidential and can only be accessed by the users or their immediate family members upon approval. However, information sharing is entirely up to users' permission. The information can only be shared to any third party such as the government health institutions or trusted private health upon request from the user in the mobile apps.

Contribution

This app will not only help to educate the community on physical and emotional wellness, but also the users' spiritual wellness. For physical wellness, users will learn about how to choose and prepare nutritious food and maintain active lifestyle by implementing correct indoor or outdoor fitness activities.

Whereas, for emotional wellness, this app will indirectly help to motivate users to maintain their good emotional state. Physical activities reduce levels of the body's stress hormones and stimulates the production of endorphins, that are the body's natural painkillers and mood elevators.

This app is also designed to educate the community on spiritual wellness, the knowledge on healthy lifestyle based on sunnah diet and lifestyles. Authentic hadiths and traditions are compiled and easily accessed by the users whenever and wherever needed. For instance, this app will remind the users about their daily prayers related to health and well-being. Therefore, this app will be a useful tool to educate the community on physical, emotional, and spiritual wellness.

Advantages

1. This mobile app allows users to track health data over time because users can retrieve their own health record and see the trend of their health status including fitness and nutritional status over the previous year. It will motivate them to take their preventive steps and modify their lifestyle according to sunnah diet and lifestyles.
2. Furthermore, this app will remind the users about their important health appointment such as preventive screening or checkups. Early detection of disease especially cancer during regular checkup will help the user to obtain early intervention for their disease.
3. This mobile app also helps the users share their health information with the trusted healthcare providers, namely, specialist, hospital, nursing home in the same state or even across the country. However, users' data on this app could not be sold to pharmaceutical and insurance companies because the information is shared in a secure way. The data could be accessed only after obtaining users' permission.

Commercialization Potential

1. Target population especially for Muslim— about 32, 776,114 Muslim in Malaysia in 2021 could be potential to be user for this apps.
2. Muslim population from other country – it is estimated about 1.907 billion Muslim around the world. It is expected to benefit more users around the world.
3. For the basic system, the cost is very cheap and for intensive system the cost is acceptable for medium level of business, therefore, the profit expected to be higher since this application only need experts in the field and marketing cost.

Research Novelty

First mobile application targeting Muslim that covered medical history tracking and others health application to ease medical consultation, save time and money. It is important for modern Muslim to use this app to monitor their health and maintain their well-being with health guideline from Quran and Sunnah. As following verse "Everything good that happens to you (O Man) is from God, everything bad that happens to you is from your own actions". (Quran 4:79). We believe Quran and Sunnah as a complete guideline especially in maintaining health, but this app will ease users to understand and apply the guideline in simple and easy steps.

References

- Bernama. (2021). Internet Access Usage Increased To 91.7% In 2020 — DOSM. Theedgemarkets.Com. [https://www.theedgemarkets.com/article/internet-access-usage-increased-917-2020—dosm#:~:text=KUALA LUMPUR \(April 12\)%3A,Statistics Malaysia \(DOSM\) today.](https://www.theedgemarkets.com/article/internet-access-usage-increased-917-2020—dosm#:~:text=KUALA LUMPUR (April 12)%3A,Statistics Malaysia (DOSM) today.)
- Johnson, J. (2021). Global Digital Population As Of January 2021. Statista.Com. <https://www.statista.com/statistics/617136/digital-population-worldwide/#:~:text=As of January 2021 there,the internet via mobile devices.>
- Koh, D. (2020). An Overview Of Malaysia's Digital Health Landscape. Healthcare IT News. <https://www.healthcareitnews.com/news/apac/overview-malaysia-s-digital-health-landscape>
- World Population Review, Muslim Population by Country (2021), Accessed on 20 June 2021 from <https://worldpopulationreview.com/country-rankings/muslim-population-by-country>

A MULTI-PLATFORM AND LOW-COST NETWORK ATTACHED STORAGE FOR IOT APPLICATIONS

Nurul Azma Zakaria

Fakulti Teknologi Maklumat Dan Komunikasi, Universiti Teknikal Malaysia Melaka,
Hang Tuah Jaya, 76100 Durian Tunggal, Melaka, Malaysia
azma@utem.edu.my

Zaheera Zainal Abidin¹, Muhammad Iqbal Mohamad Zaimi²

¹Fakulti Teknologi Maklumat Dan Komunikasi, Universiti Teknikal Malaysia Melaka,
Hang Tuah Jaya, 76100 Durian Tunggal, Melaka, Malaysia,
²Grass Valley Malaysia Sdn Bhd, Bangsar South City,
Jalan Kerinchi, 59200 Kuala Lumpur, Malaysia
zaheera@utem.edu.my, muhdiqbalzaimi@gmail.com

Highlights: Everyday people use digital storage to store digital information. But the personal device has a limited amount of storage. A solution to this problem is using a dedicated storage device such as Network Attached Storage (NAS). However, the NAS device that is commercially available is expensive and not suitable for personal use. Thus, this invention aims to provide a fully functional NAS but with a fraction of the price. The product integrates both hardware and software components. The project produces a low-cost NAS with multi-platform accessibility to improve NAS management that supports IoT applications.

Keywords: *Network attached storage, Dedicated storage, Extended storage, Low-cost NAS, Multi-platform NAS, NAS management.*

Introduction

In this era, global technology advancement relates to the Internet of Things (IoT) and the Fourth Industrial Revolution (IR 4.0). New integration of the computer and automation is required to complete a task. Align with this development, the computerized system has shifted to the distributed computing which supports all devices connected to the network and have the ability to communicate with each other inside the network. The necessity of network storage has become critical when the dependency of the data involved in communication has increased daily. Network Attached Storage (NAS) has been introduced in the early 2000s to solve the problem of limited device storage and decentralized data management in the network environment. There are NAS commercial products on the market such as Seagate (iPrice, 2021a) and Western Digital (iPrice, 2021b), but the prices are expensive and each of them comes with different features and functions. On the other hand, in this IoT age, people interact actively over the Internet. Unfortunately, the problem arises when the personal device that intends to provide interactive activity now becomes limited because the personal device normally comes with smaller and limited storage. The personal device is originally developed to provide portability instead of providing larger data storage. Thus, a cheaper device with more storage space is demanding to solve these issues.

However, the real challenge is to produce affordable NAS without affecting the functions of NAS itself. The microprocessor is the best solution to be used as the NAS controller and as a management device. The microprocessor offers a cheap price with similar functionality as a computer. It comprises the motherboard which controls all the electronic functions and operating system for hardware and resource management. In 2012, Raspberry Pi has been officially launched. Over time, the Raspberry Pi has evolved through several versions and extended its functions for other applications such as robotic, manufacturing, and agriculture. The combination of an external hard disk drive (HDD) with Raspberry Pi creates an improved NAS size at a cheap price compared to a commercial product for easy collaboration and effective information sharing. The NAS is not only limited to files sharing instead it also supports backup and recovery functions. Therefore, the project aims to develop a low-cost NAS device with extended storage that can be accessed and managed through multiple platforms to support the needs of IoT applications.

Methodology

The methodology selected for this project is the waterfall model (Van Casteren, 2017) which is known as the linear-sequential life cycle. This model required to complete each of the phases before can proceed to the next phase and there would be no overlapping for each phase. The waterfall model often uses for the project that does not require incremental on each phase and is one of the popular strategies for Software Development Life Cycle (SDLC). The waterfall model consists of seven (7) phases which are, requirement, analysis, design, implementation, testing, deployment, and maintenance.

Implementation

The project is divided into two (2) parts which are hardware development and system development. For the hardware development, the proposed NAS used Raspberry Pi 3 Model B+ as the microprocessor which is responsible as the main processing unit. The external HDD was connected to Raspberry Pi as the storage medium. The Raspberry Pi comes with the open-source "Raspbian" operating system which is based on UNIX. Raspberry Pi has four USB ports to support extended storage through this port. Moreover, Raspberry Pi supports two types of connections which are wireless and wired. To allow the device to function over the network, it was connected to network devices like the wireless router. The wireless router should provide the connection between Raspberry Pi and other devices in the network.

The second part of the project is system development named NAS management. A web-based application was developed for the NAS management software to support multi-platform accessibility. PHP, HTML programming languages with the combination of MySQL for the database were used for the developed system. The system uses the new ability of HTML to support responsive views and suit any current web browser. The system was developed with four main modules which are the dashboard, file management, media player, and user management modules. Only the user with a valid account can access and interact with the system. The developed system integrates with the NAS device to allow direct uploading and downloading from the NAS and enable information display of NAS services. Figure 1 shows the overview of the proposed solution.



Figure 1 Overview of the proposed solution

Conclusion

The NAS server and applications can be easily operated and managed without additional technical skills through the web browser. There are some significant strengths of the product such as providing support for extended storage, cost-saving through less power consumption, and a secured system with only allow access using the user account and password. This product can be commercialized due to its benefits in providing portable and affordable network storage devices for individuals or small companies. The product shows the feasibility of integrating various Information and Communication Technology (ICT) knowledge which supports the development of smart devices that suits the IoT applications for the benefit of society. Furthermore, it promotes the learning of related computer science topics. As a conclusion, this study may become the framework for the advancement of network storage devices and opens new opportunities for the development of low-cost NAS in the future.

Acknowledgment

A high appreciation to the Ministry of Higher Education Malaysia for providing financial support under research grant (FRGS/2018/FTMK-CACT/F00392), and Fakulti Teknologi Maklumat Dan Komunikasi, Universiti Teknikal Malaysia Melaka (UTeM) for facilitating the work done in this study.

References

- iPrice. (2021a). Seagate NAS Storage in Malaysia Price List for June 2021 [Online] Available: 1: <https://iprice.my/seagate/computing/external-storage/nas-storage/?show-filter=1>
- iPrice. (2021b). Western Digital NAS Storage in Malaysia Price List for June 2021 [Online] Available: 1: <https://iprice.my/western-digital/computing/external-storage/nas-storage/?show-filter=1>
- Van Casteren, W. (2017). The Waterfall Model and the Agile Methodologies: A comparison by project characteristics– short. Working Paper, DOI: 10.13140/RG.2.2.10021.50403

TECHNOLOGY IMPROVEMENT OF MINI SMART ARTIFICIAL INCUBATOR SYSTEM (SMART FIN-Tech) FOR FISH EGG

Suniza Anis Mohamad Sukri

Faculty of Agro Based Industry, Universiti Malaysia Kelantan, Jeli Campus, Malaysia
suniza@umk.edu.my

Zulhisyam Abdul Kari@Abdullah, Hasnita Che Harun, Zuharlida Tuan Harith, Mohd Fareezman Zamzuri

Faculty of Agro Based Industry, Universiti Malaysia Kelantan, Jeli Campus, Malaysia
zulhisyam.a@umk.edu.my, hasnita@umk.edu.my, zurhalida@umk.edu.my, fareezman.f18b0066@siswa.umk.edu.my

Highlights: Artificial incubation of fish eggs is a hatchery procedure that improves a commercial fish culture operation's economic efficiency and also for increasing hatching and survival rates. Removing the eggs from the parents can increase egg production by reducing the time between spawning. The artificial egg incubation will be improved a commercial hatchery's fry production and profitability. This mini smart artificial incubator technology will be used to check the egg hatching rate and fry survival rate.

Key words: Artificial incubator, fish egg, hatching and survival rate

Introduction

Tilapia culture has been experienced in additional than 100 countries round the world (Mikori et al., 2017). In nature, tilapia eggs need to overcome many harmful factors like predation and continual change within the natural environment (Beveridge and Mcandrew, 2000). Indeed, oldsters of most organisms have their own role in rising their generations as protection of young ones from predators is a very important and expensive element of parental care and this investment. Could also be adjusted to predation risk for the offspring (Taborsky and Foerster, 2004). To ensure that, fishes change their tending behaviour in coincidence with dynamic conditions within the nest, each on an everyday and throughout the development of embryos.

Seed production normally easily to achieve if the egg are collected every 5 days and the eggs collection is up to 400-3000 fry/m²/month or 200-1500 fry/female/month. A better result can be obtained if the unhatched eggs are kept in an artificial incubation system until their readiness for active feeding (Pradeep et al., 2011).

In Malaysia, technology based on the artificial incubator in aquaculture industry such as for Tilapia eggs cannot be used by breeders due to price factors that are too expensive to build it. Normally breeders use a natural incubators stored in the fish's mouth. Due to uncontrollable and fluctuation factors in the fish's mouth, such as temperature, egg hatching and survival rates are commonly reported. Some environmental factors that influencing the hatching rate and survival of developing eggs in an incubation system. Temperature is one in all the foremost potent environmental factors affecting embryonic development in fish eggs beside pH and ammonia.

Incubation and high survival rate can increase high seed production which will be used for the growth process. So this technology can give an effect to the increase in tilapia production in Malaysia and the world due to the high survival rate and hatching rate of eggs produced. Real artificial incubator systems are very expensive to procure by breeders in the aquaculture industry which will cause breeders to require high cost to start in this field and will also delay cost return due to high operating cost to start this business. Therefore, this technology and experiment will be executed in order to satisfy the question of whether the use of smart artificial incubator in aquaculture breeders causes either positive or negative effects.

Content

Smart Artificial Incubator design

A new design of effective portable Mini Smart Incubator System (SMART FIN-Tech) is represented in Figure 1.0. The technology will be designed for laboratory use. This SMART FIN-Tech for tilapia eggs will be designed using plastic tray and water filter will be placed to recycled water in water system. The water filter will be designed using a sponge as filter device to filter the dirt or particles before it transfer through the piping system. The pipe system will be build up and will be placed with a frame made using aluminium rods. This mini smart incubator technology will comes with 3 special incubation jars system. The jars can be filled up to 1000 eggs each. A plastic rod will be used as a place for water to come out of the piping system and into the plastic jar. An aquarium pump will be used to transfer water to the system.

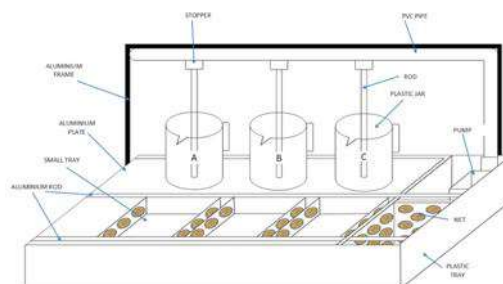

Figure 1.0: Design of SMART FIN-Tech

Hatching Rate and Survival Rate

The eggs will be monitored 2 times daily at 8.30 a.m. and 5.00 p.m. until they reached of fry stage on days-11. The water quality such as temperature, pH, Dissolved oxygen will be observed every day. During the monitoring period, the damaged eggs will be removed and will be recorded in the daily data. The total number of hatching eggs will be calculated after all the eggs are completely hatch in each jar on the 4th day for Smart Artificial Incubator and the Real Artificial Incubator System. The result of hatching eggs in each jar will be calculated then the egg hatching rate will be calculated too to find out the percentage for the hatching rate of eggs for each jar.

The main parameter of this study is to the success tilapia/fish egg to hatch. Hatching rate is the percentage of eggs hatched that can be known and calculated using the formula, namely:

$$\text{Hatching Rate (HR) (\%)} = \frac{\text{hatched egg}}{\text{Total egg}} \times 100\%$$

Survival rate will be gained after the maintenance of tilapia larvae for seven days or when the yolk of tilapia egg has been completely absorbed. The Survival rate will be measured comparing the presentation of the number of fish that will survive (t) during the study period with the number of hatched eggs (0). The formula is showed as below:

$$\text{Survival Rate (SR) (\%)} = \frac{\text{Larvae (t)}}{\text{Larvae (0)}} \times 100 \%$$

Expected result

The expected outcome from this study based on the technology improvement in Smart Artificial Incubator (SMART FIN-tech) for aquaculture that produce is to improve the hatching rate and survival rate for tilapia (*Oreochromis niloticus*). This technology is believe can simulate all the natural process such as incubate by fish with help of their fins to provide a constant water flow for better hatching of fertilized eggs using mini smart incubator.

Some advantages of the system can be found including the application lab/personal use, embryonic development can easily to be observed and monitor, rotten/ unhatched egg can be judged and removed easily, the system can be operated continuously, easy to clean, the production cost on fish seed is less or will be reduced and the system can be moved from one place to another easily.

Acknowledgement

We would like to express our special thanks of gratitude to Faculty of Agro Based Industry and all person that have contribute directly and indirectly into this project.

References

- Beveridge, M. and Mcandrew, B. J. 2000. Tilapias: Biology and Exploitation. 487p. Kluwer. Doi: 10.1007/978-94-011-4008-9
- Fareidah, F., Widodo, M. S., Nuswantoro, S. and Rizal, M. K. (2021). Hatching of Nile tilapia (*Oreochromis niloticus*) egg in the hatching medium use salinity media and bromelain enzyme. The 3rd International Conference on fisheries and Marine Sciences. IPO Conf. Series: Earth and Environment Science 718 (2021) 012027 doi:10.1088/1755-1315/718/1/012027
- Mikori, A. J., Abuom, P.O., Kapiyo, R., Anyona, D. N. and Dida, G. O. 2017. Effects of water physico-chemical parameters on tilapia (*Oreochromis niloticu*) growth in earthen ponds in Teso North Sub-County, Busia County. Fisheries and Aquatic Sciences 20:30 doi:10.1186/s41240-017-0075-7
- Pradeep, P. J., Srijaya, T. C., Miithun, S., Shaharom, F. and Chatterjii, A. 2011. Seed production and hatchery management techniques in tilapia.
- Taborsky, B. and Foerster, K. 2004. Female mouthbrooders adjust incubation duration to perceived risk of predation. Animal Behaviour 68(6): 1275-1281. doi.org/10.1016/j.anbehav.2004.03.005
- Valeta, J. S., Likongwe, J. S., Kassam, D. and Maluwa, A. O. 2013. Temperature-dependent egg development rates, hatchability and fry survival rate of Lake Malawi Tilapia (Chambo), *Oreochromis karongae* (Pisces: Cichlidae). International Journal of Fisheries and Aquaculture 5(4): 55-59. Doi: 10.5897/IJFA 12.056 ISSN 2006-9839

LOCKER SAFETY ALARM WITH BLYNK NOTIFICATION

Mohamed Faris Farhan bin Mohamed Rohi

Kota Bharu Polytechnic, Kelantan
farsi.farhan0202@gmail.com

Zainuddin bin Omar

Kota Bharu Polytechnic, Kelantan
Zainuddinomar620806@gmail.com

Highlights: 'Locker Safety Alarm with Blynk Notification' Control System is designed to sense the movement in the room or any point where the security system is required. The idea arises in order to control the movement of the intruder who tend to break through the room or places where we keep our valuable in the locker or wardrobe to keep for safety reason. An infrared sensor is installed at the lamp which is located near the wardrobe where our valuable is placed. Any movement nearby will be sense by the infrared sensor and it will activate to turn ON the lamp and the buzzer also will turn ON. The activation of the sensor will be identified by the controller (ESP 32 Microcontroller System) which is being installed in the room to activate by sending the information (signal) to the owner. The owner will receive the information in the handphone. The Blynk system which is the part of the control system in the handphone will received the information that the intruder is in the room. With this information, the owner can plan to inform somebody else to take action to the intruder. The 'Locker Safety Alarm with Blynk Notification' system will help the owner to prevent or protect the valuable from any intruder which plan to steal something in the room. This control system design can be applied not only for specific room but also can be installed at any places to sense any intruder who plan to enter the owner property for example at the entrance of the house, gate entrance etc.

Key words: *Blynk Notification, ESP 32 Microcontroller System, Infrared Sensor, Control System, Security system.*

Introduction

In this world, we can find many sensors around us. Most home or factory automation systems need sensors as the main equipment in an automation system. Examples of these automation activities such as turning on the TV with remote control, lights that can turn on when the day gets dark, CCTV that can move to follow the movement of people around, weather monitoring equipment, temperature measuring equipment, tools used to detect the occurrence of fire. For application, the sensor that can work to sense the motion or movement under the light should be put as our priority nowadays. (Motion Sensor Light). This motion sensor light operates when the object is affected, the light will come on and will send a signal to the user if someone enters the house or when there is movement in the house the light will start to turn on and also send an emergency signal by itself within the time is set up by the user.

Project background and studies on Infrared Sensors

Infrared sensors are electronic devices used to sense certain features around them. It does this by emitting or detecting infrared radiation. Infrared sensors are also capable of measuring the heat emitted by objects and detecting movement. Infrared technology is found not only in industry, but also in everyday life. Televisions, for example, use infrared detectors to interpret signals sent from remote controls. Passive infrared sensors are used for motion detection systems, and LDR sensors are used for outdoor lighting systems. The main benefits of infrared sensors include their low power requirements, simple circuitry, and portable features.

Infrared Radiation Theory

Infrared waves are invisible to the human eye. In the electromagnetic spectrum, infrared radiation can be found between the visible region and the microwave. Infrared waves typically have wavelengths between 0.75 and 1000 μ m. The infrared spectrum can be divided into near IR, intermediate IR and far IR. The wavelength region from 0.75 to 3 μ m is known as the near infrared region. The area between 3 and 6 μ m is known as the mid -infrared region, and infrared radiation having wavelength higher than 6 μ m is known as far infrared.

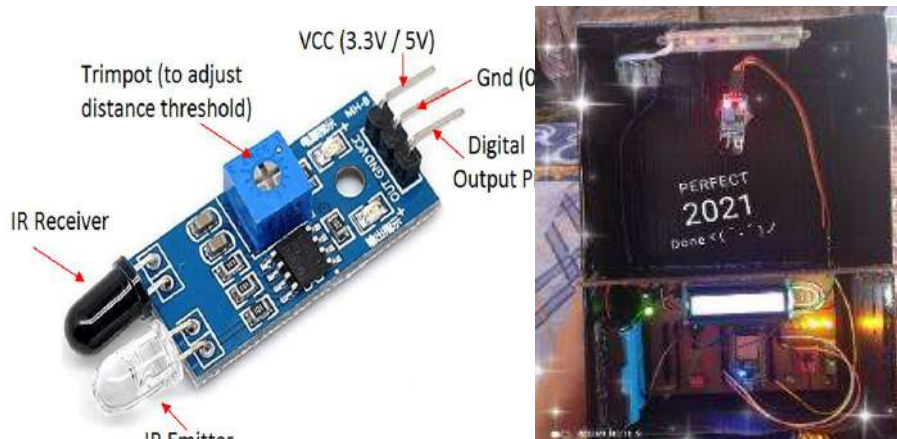

Figure 1: Infrared Sensor Locker Safety Alarm with Blynk Notification controller

How The Control System in Locker Safety Alarm with Blynk Notification Work:

- I) The sensor sense the moving object nearby.
At the beginning when the sensor sense any movement or object nearby, LCD will show the Visitors: No Motion: 0
- II) The image will appear on LCD on the controller.
Next, after the sensor sense the second movement of the object, LCD will count the object pass through the sensor. LCD will show the Visitors: No Motion: 1
- III) Led will turn ON and the buzzer will be activated.
When the sensor sense the object for the second time, the LED light and the buzzer will be activated according to the program being set up. The buzzer will keep on activated until the owner turn OFF/Reset the system. This gives the warning to the intruder not stay much longer at the location.
- IV) The message "Someone here" can be seen in the owner's Handphone.
When the infrared sensor sense the object for the second time, the ESP32 in the controller will be activated and will send the message indicator through the BLYNK system in the owner's handphone. The words message "Someone here" can be seen in the owner Handphone screen. With this information, the owner can take action as soon as possible to solve the problem.

References

- Jerrett, M., Gale, S., & Kontgis, C. (2010). Spatial modeling in environmental and public health research. *International Journal of Environmental Research and Public Health*, 7(4), 1302–1329. <https://doi.org/10.3390/ijerph7041302>
- Miller, H. J. (2004). *Tobler's First Law and Spatial Analysis*. 94(November 2003), 284–289.
- Tobler, W. R. (1970). A computer movie simulating urban growth in the detroit region. *Economic Geography*, 46, 234–240. <https://www.jstor.org/stable/143141>
- Ya'acob, S. H., & Mar Iman, A. H. (2020). The Spatial Influence of Environmental and Anthropogenic Factors on The Pattern of Air Pollution in Malaysia. *IOP Conference Series: Earth and Environmental Science*, 549(2020). <https://doi.org/10.1088/1755-1315/549/1/012011>

ZoN- ELECTRONIC SEMICONDUCTOR DEVICES

Arlina Binti Ali

Advanced Material Research Cluster, Faculty of Bioengineering and Technology, Universiti Malaysia Kelantan, 17600 Jeli, Kelantan, Malaysia

Hidayani Binti Jaafar, Teo Pao Ter, Sarizam Binti Mamat, Norfadhilah Binti Ibrahim, Mohamad Najmi Bin Masri, Mohamad Bashree Bin Abu Bakar, An'Amt Bin Mohamed Noor, Azfi Zaidi Bin Mohammad Sofi

Advanced Material Research Cluster, Faculty of Bioengineering and Technology, Universiti Malaysia Kelantan, 17600 Jeli, Kelantan, Malaysia

arlina@umk.edu.my , hidayani@umk.edu.my , teopaoter@umk.edu.my , sarizam@umk.edu.my, nfadhilah@umk.edu.my, najmi.m@umk.edu.my, bashree.ab@umk.edu.my, anamt@umk.edu.my & azfi.ms@umk.edu.my

Highlights: Zinc oxide (ZnO) nanostructured had been interested today because of their unique properties in electronic devices. ZnO nanostructured was synthesized via hydrothermal method by varied the pH values. The effect of different pH values was changed the morphological, structural and optical properties. The ZnO nanostructured use in various applications like sensors, chemical sensors, biosensor, superconductor, optoelectronic devices, cosmetics etc. Therefore, it is usually used in light emitting diodes and solar cells because having high exciton binding energy nearly 60 meV and also is environmentally friendly.

Key words: zinc oxide, nanostructured, 60 meV and semiconductor

Introduction

Recently, shape control has raised significant study in the fabrication of semiconductor nanocrystals, metal nanocrystals, and other inorganic materials [1]. Many deposition techniques have been employed to synthesize nanostructure such as nanowires, nanobelts, nanobridges, nanonails, nanoribbons, nanorods, nanotubes [2]. Zinc oxide nanostructures (ZoN) used in many applications such as photo-electrochemical cells, cosmetics, fabric, dye sensitized solar cell, photovoltaics, photo-catalysts, UV detectors and field emission due to zinc oxide have wide band gap which is around 3.37 eV at ambient temperature. There are lots of methods that was used in synthesize zinc oxide which are sol gel, thermal decomposition, hydrothermal, chemical vapour deposition, and co-precipitation [3]. The problems during synthesizing nanoparticles are stability and aggregation, control crystal growth, morphologies, sizes and distribution are important issues and continue to be solved [4]. Hydrothermal method had been employed to synthesize of ZoN nanostructures nanowires, nanobelts, nanobridges, nanonail, nanoribbon, nanorods and nanotubes. The pH of solution appears to be critical parameter for the phase formation, particles size and morphology of the structure during synthesizing process [3]. The properties of ZoN normally depends on the synthesis method and conditions during processing.

Methodology

The nanostructures were prepared from zinc chloride (ZnCl) and ammonium hydroxide (NH₄OH). The mixed solution was stirred for 1 hour at room temperature to achieve homogenization. The pH will be adjusted from 7, 8, 9, 10 and 11 by controlled the amount of ammonium hydroxide. Then, the solution heated using Teflon lined steel autoclave at 180°C for 24 hours. The precipitate obtained was washed several times with ethanol and distilled water. After washed several times, precipitation filtered with vacuum pump followed with dried at 60°C for 12 hours and examined in terms of their structural and physical properties.

The X-ray diffraction (XRD) pattern of the prepared ZnO was recorded using Bruker D2 Phaser with Cu K α radiation at the Bragg angle ranging from 10° to 90°. The crystallinity and crystal phases were determined by XRD. The absorbance spectra have been recorded using a UV-1280 Multipurpose UV-Visible Spectrophotometer. The optical properties of the samples were also studied by the UV-visible (UV-vis) absorption in the range from 200 to 800 nm at room temperature. Samples were observed using scanning electron microscopy (SEM) for surface morphological images using JEOL-JSMIT-100.

Result and Discussion

Fig.1 shows the X-ray diffraction (XRD) pattern of zinc oxide nanostructures as a function of pH variation 7, 8, 9, 10 and 11. The detected (h k l) peaks were at 2 θ values of 31.7°, 34.4°, 36.2°, 47.5°, 56.6°, 62.8°, 66.3°, 67.9°, 69.0°, 72.5°, 76.9°, 89.6° are correspond to the lattice plans (100), (002) (101) (102) (210) (103) (200) (212) (201) (004) (202) and (203) respectively. All the diffraction peaks can be indexed to hexagonal wurtzite structure of ZoN with lattice parameter constant of a= 3.249 Å and c=5.206 Å comparison with the standard with the agreement COD 9008877[6]. The intensity of the graph is increasing with the increase in pH value may be due to the different precursor used as [7] reported the intensity of the pH value is decreasing with the increase in pH. The sharp peak of the XRD graph corresponds to the 101 indicate a high crystalline of the samples. The strongest peak corresponds to the 101 plan is more prevalent for the nanostructure as reported by Lupan et al. (2007). No diffraction peaks from impurities were detected.

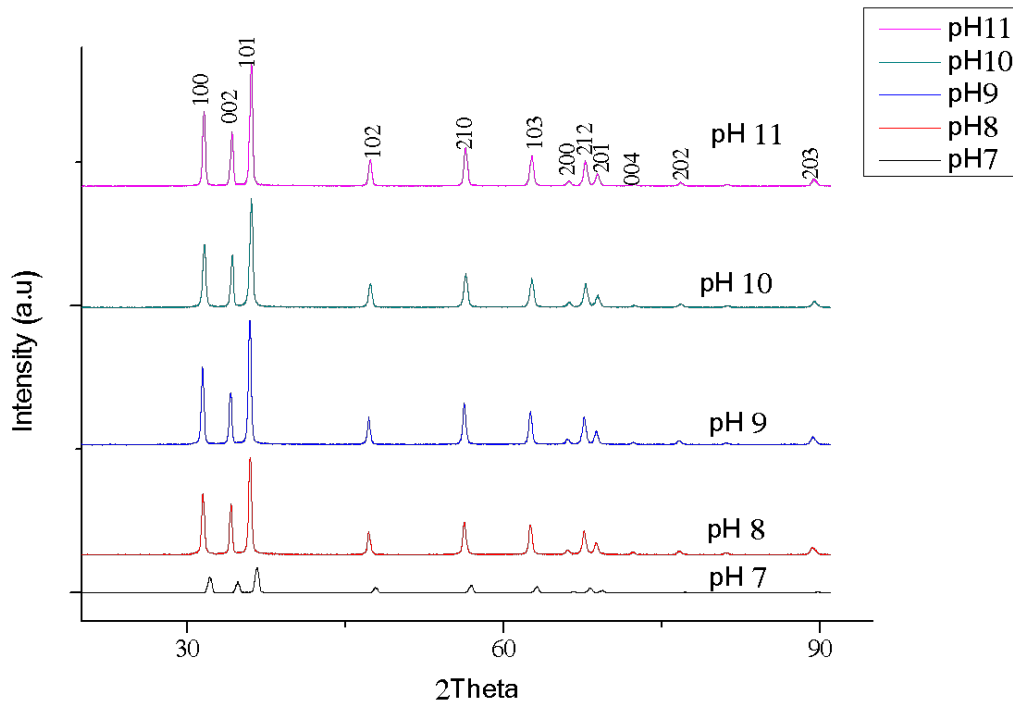

Figure 1.0: X-ray diffraction patterned of ZnO nanostructures prepared at different pH values

Scanning electron microscope image of the ZnO synthesized at the different pH values presented in Fig 2. Fig 2 shows the morphology variation structure was observed hexagonal flower-like to rod-like structure. Results in a complete flower like characteristics of the ZnO controlled by the pH of the precursor.



Figure 2.0: SEM image of ZnO nanostructures prepared at different pH values

Conclusion

In summary, the effect of pH on the morphological ZnO has been examined. The crystallized ZnO powders with different morphology have been successfully prepared by a convenient hydrothermal method. Upon using different amount of ammonium hydroxide as solvents, the morphologies such as rod and flower like the structure of the ZnO powders are obtained. It has been found that pH values were increased from 7 to 11 significantly influences the shape structures. Therefore, it is possible to control the shape of the ZnO nanostructure by adjusting the pH precursor.

Acknowledgement

Authors wish to thank Universiti Malaysia Kelantan for support the financial and final year student who directly involved in this study.

References

- Ghoderao, K. P., Jamble, S. N., & Kale, R. B. (2018). Influence of pH on hydrothermally derived ZnO nanostructures. *Optik*, 156, 758-771.
- Kumar, Brajesh, et al. "Green approach for fabrication and applications of zinc oxide nanoparticles." *Bioinorganic chemistry and applications 2014* (2014).
- Sambath, K., Saroja, M., Venkatachalam, M., Rajendran, K., & Muthukumarasamy, N. (2012). Morphology controlled synthesis of ZnO nanostructures by varying pH. *Journal of Materials Science: Materials in Electronics*, 23(2), 431-436.
- Wahab, R., Ansari, S. G., Kim, Y. S., Song, M., & Shin, H. S. (2009). The role of pH variation on the growth of zinc oxide nanostructures. *Applied Surface Science*, 255(9), 4891-4896
- Xu, H., Wang, H., Zhang, Y., He, W., Zhu, M., Wang, B., & Yan, H. (2004). Hydrothermal synthesis of zinc oxide powders with controllable morphology. *Ceramics International*, 30(1), 93-97.

VEHICLE ALERT SYSTEM

Ts. Mahayudin B. Saad

Department of Electrical and Electronic Technology
Arau Vocational College, Perlis, Malaysia
mahayudin@kvarau.edu.my

Muhammad Danish Bin Syujahuddin Ganeson

Arau Vocational College, Perlis, Malaysia
inovasiengkvarau@gmail.com

Highlights: Vehicle Alert System is designed to detect a person (child) at the back seat and it will send a notification to the parents or drivers via Telegram application if they forget someone is left inside the car. The system also can detect carbon monoxide gas leaking into the car while the engine is still on. The buzzer will beep and the window opens automatically once it detects the high amount of carbon monoxide inside the car. Other than that, the system is able to unlock the car from outside once the driver sends a message to the telegram. If the phone is inside the car, they can use any mobile phones and send through SMS (short message service) to the system.

Key words: notification, telegram, sms, unlock, detect, carbon monoxide

Introduction

Transportation especially cars is vital in our daily lives. The high number of vehicles on the road not only have caused the increasing number of road accidents but also contributed to the unwanted tragedy once the car has been parked. There were many cases of children abandoned at the back seat of the car which brought to death cases. Besides, there were death cases of adult who were sleeping inside the car with the engine was still on which had caused to the carbon monoxide poisoning. Then, the increasing number of toddlers and babies were locked inside the car automatically when their parents had left them alone. At this age, they were unable to understand the panic situation and of course they did not know how to unlock the car even with the key inside. So, the idea of designing this project is to overcome these problems faced by most road users.

Problem Statement

Death of trapped children inside the car happened because of their parents' negligence. For working parents, it is a routine for them to send their kids to school and nursery every morning but in some situations, if the child is sleeping on the seat behind them, they might forget to complete the routine maybe because of the work burdens at the office. Unfortunately, this forgottenness has made their parents drive to the office and park their car at the open space and hot without realizing the existence of their kids. Consequently, these children face suffocation till death because of the lack of oxygen and high temperature inside the cabin.

In some cases, there are also increasing number of death cases of carbon monoxide poisoning while driver or passenger sleeps inside the car. This usually happens when they are too tired to continue their long journey or on their way back from office. They think by sleeping while turning on the air conditioning is safe for them. Unfortunately, if they are exposed to this situation for long hours, the gas is able to leak into the cabin. Once it reaches at 90 ppm, it able to give side effect such as death to them.

There are cases of children and babies are locked inside the car unintentionally by their parents or because of technical problems. Even though the key is inside, but for these innocent kids, still hard for them to understand the situation and to take action. If getting a help from fireman or key expertise is taking a lot of time, parents tend to break the window which is risky for the kids inside who might get hurt and also need to pay for the cost.

Objective:

There are three main objectives:

- i. Designing a system which able to detect any object inside the car and send a warning notification via telegram.
- ii. Developing a warning system to the driver when carbon monoxide leaks into the car.
- iii. Making an alternative of unlocking a car once it locked automatically.

Methodology

The method used for development of the project is based on 'Design Thinking' which is problem solving approach. There are 5 main phases which are Empathy, Define, Ideate, Prototype and Testing. The model is chosen because it helps in solving the complexity of the problem.

i. Phase 1 : Empathy

During the phase, a study process is done by interviewing about the arising problem has shown the increasing number of death cases among children who have been left alone inside the car. They experience suffocation because of lack of oxygen and high temperature inside the car. There are also death cases among adults because of carbon monoxide leaks into the cabin. Besides, the cases of children are locked inside the car happen every day. Early study has been made by gathering the data through questionnaire. Hence, this has helped the designer to understand the problems faced by the users and helped them to develop the system. The other way of gathering data is by reading and evaluating. The designer able to identify that once the driver locks the car, they do not see what is left inside the car anymore. The second problem is when a long journey driver gets tired, they tend to sleep inside the car for long hours and this made them to be exposed by poisoning gas of carbon monoxide. The consumer always complains about the lack of indicator and notification which are vital to warn the sleeping driver. The third problem is when the car is locked automatically and based on the questionnaire's result, consumers complain that there is no alternative to unlock the car rather than breaking the window.

ii. Phase 2 : Define

This phase is to determine the consumer's need in solving the problems. Besides, this warning and safety system functions when carbon monoxide leaks into the cabin which also able to detect the amount of leaked gas that brings to death. Next, a consumer also needs an alternative to unlock the car just by sending a notification via telegram and short message service (SMS). Figure 1 shows The physical design of Vehicle Alert System.

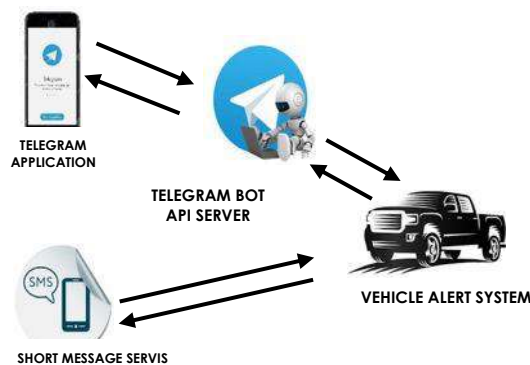

Figure 1 : The physical design of VAS

iii. Phase 3 : Ideate

This phase focuses on the rough idea of finding a solution that has been determined in the previous phase. The process involves a mechanism of the system and materials needed. The Vehicle Alert System (VAS)'s prototype comprises of three main parts which are circuit components, software and overview of the project. The system involves the building of the component and software which is able to be communicated with consumer via telegram and sms.

iv. Phase 4 : Prototype

The prototype's development divided into three parts which are the circuit design, programming system and panel box design. During the circuit design, the electronic components are connected to ESP32 board. During the programming system, it focuses on the process by using Arduino IDE on the board for the detector of the input controller which consists of switch, PIR (passive infrared sensor), DHT11 (temperature and humidity sensor) and MQ-7 (carbon monoxide sensor). For output, the system uses LED indicator, Buzzer, Relay Module, LCD display and Motor drive module. During the development of programming system output, it consists of TelegramBOT cloud to send data or information to the telegram. During the panel box design, the prototype model describes the process of its function. Figure 2 shows the circuit connection for physical prototype integrated to car's system. Figure 4 shows the VAS prototype model.



Figure 2 : Integrated between VAS and car's system

v. Phase 5 : Testing

The main objective at this phase is to test the function and usage of the prototype. The functional test is to check the sensor input of seat sensor, PIR sensor, DHT11 sensor and MQ-7 sensor while the outputs are LED, buzzer, relay module and notification to the telegram. Table 1 shows the result of recorded test from the first problem simulation. Once the seat sensor detects an object, switch 'on' and LED light 'on', then VAS sends a notification to the telegram.

Findings

Based on the ten times functional test for the first situation, Table 1 shows the result of the test. From the tests, 90% output functions as well as the second test. For the third and fourth tests, the outputs are 80% and 90%.

Table 1: The result of first functional test

TEST	FREQUENCY	OUTPUT
1. Sensor Seat detect object	10	90 %
2. Sensor PIR detect movement	10	80 %
3. Sensor Seat dan PIR detect object	10	80 %
4. Sensor DHT 11 >40°C, Seat & PIR detect object	10	70 %

Figure 3 shows the result of functional test in the first situation. The result for first and second tests are the same, 90% but there is a different result for third and fourth test which is because of the input of seat sensor, PIR sensor and temperature sensor (DHT11) happen at the same time that might cause a little error in the C programming. Anyway, this has not become an obstacle to the operation of the project.

The result of the second situation shows 70% success which has been done in the close space according to the safety's SOP. The test also has been done for ten times just to see the ability of carbon monoxide sensor (MQ-7) to detect the gas calibration. Figure 9 shows the graph of MQ-7 gas reading compared with time. When VAS detects a gas reading at 35 ppm, a warning buzzer is on and window opens automatically.

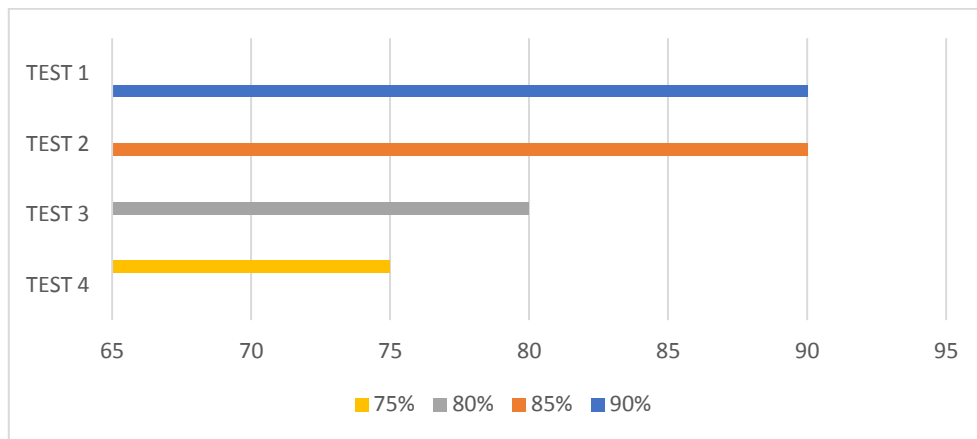

Figure 3 : Graph of First situation test

Commercial Value

This product is designed to be easily integrated with any current vehicle system and user friendliness especially for safety concerned consumer. The interesting part of this system is on the price which can be offered about RM300 excluding installation service. This is considered cheap when compared to the safety that the system offered which is really value for money. The target consumers are family especially with babies and kids as well as long journey drivers.

The system is a combination of three main functions which are alert notification, detecting carbon monoxide system and an alternative of unlocking a car. These functions comes together in a single device which can be easily installed inside the vehicle. The safety of the current vehicle system is untouched and this VAS can be an added value to the vehicle.

Advantages of the Innovation

First, the ability of the VAS is to warn parents or drivers if their children are left alone unnoticeably and also helping to decrease the number of deaths as well. Once the window opens automatically, it helps to release the heat inside the cabin avoiding heat stroke to the passengers as well as warns them when the car alarms.

Second, driver and passengers need not to worry if they fall asleep in the car since the system helps to warn them if the carbon monoxide leaks into the cabin besides releasing the gas once the window opens automatically.

Third, the system helps to reduce the loss of repairing the car or paying for the service of unlocking the car when it locks automatically with the key and child are trapped inside it. The system able to unlock the car by sending a notification via telegram or SMS.

Conclusion

Based on the result of the study, it can be concluded that the easy, fast and friendly system of VAS is able to save many lives of the drivers, passengers especially children. The result of the test has shown positive responses of VAS as well as its functions according to the objectives of this project. The system is easy to be installed in any types of vehicles especially for concerned parents or drivers in ensuring the safety of their children or even their own lives. It is hoped that this project is able to benefit not only for Malaysian but also worldwide users.

References

- Alexander Maier, Sharp Andrew, Yuriy Vagapov, (2017). Comparative Analysis and Practical Implementation of the ESP32 Microcontroller Module for the Internet of Things. 10.1109/ITECHA.2017.8101926
- H. Setiaji, I.V. Papatungan (2018). Design of Telegram Bots for Campus Information Sharing. IOP Conf. Ser. Mater. Sci. Eng., vol. 325, no. 1
- Mohamad Fokhrulradhi Mohd Sha'ri, Mohd Fo'ad Rohani (2018). Sistem Pemantauan Tahap Pencemaran Asap dan Gas Beracun Karbon Monoksida di dalam Kenderaan. ISBN 978-967-2171-29-4
- N. M. Z. Hashim, H. H. Basri, A. Jaafar, M. Z. A. A. Aziz, A. Salleh, A. S. Ja'afar (2014). Child in car alarm system using various sensors. ARPN Journal of Engineering and Applied Sciences, ISSN 1819-6608. 9(9)

IOT SOLAR REFRIGERATOR

Nur Sahira binti Ilias

Politeknik Kota Bharu, Kelantan
 nursahirailias99@gmail.com

Nur Filzah binti Mohd Fauzey, Muhamad Tarmizie bin Ismail

Politeknik Kota Bharu, Kelantan
 filzah@pkb.edu.my

Highlights: A refrigerator is a mechanical device for storing perishable food. This appliance is basically designed as a cooling unit. Refrigerators are also common electrical appliances in almost every home. Engineers have tried to design and use the latest technology to make refrigerators more efficient in saving energy yet they are still categorized as the appliances that use the most electrical power. If the source of electricity is not available or disconnected, it will be a problem for all consumers who have this equipment in their homes. Therefore, we tried to overcome this problem by creating a project that uses alternative sources to replace the source of electricity. The project that we will develop is to use solar energy and also IoT (Internet of Things) to control the heat of temperature to make sure it always cool. The electric current from solar energy results from the drying of solar panels into sunlight. The energy supply will send energy to the cooling fan to blow cold air from the evaporator to the rest of the refrigerator. The beneficial for users are; improving convenience, comfort, energy efficiency uses and level of safety in the home. The DHT II sensor works to measure the temperature and humidity of the air in the refrigerator. If the temperature of the refrigerator is high, GSM will send a short message to the phone user. As the result, this can save more electricity consumption as well as be able to control the temperature of the refrigerator remotely using IoT.

Key words: refrigerator, solar, IoT, temperature, energy, sensor, electric

Introduction

A refrigerator is a common electrical appliance in almost every home owns it to keep food cool and help food stay fresh longer, to slow down the activity of bacteria by storing perishable goods such as vegetables, raw meats, milk products and so on. This refrigerator is designed to use IoT (Internet of Things) will control the temperature so that it is always cool. IoT is designed to make for users able to control the temperature just by using a smartphone. For this project, we also use an alternative solar as the power source. In general, the use of solar systems requires high costs. However, the consumption needs to issue a capital for once only. The installation of solar panels can last up to 10 years or more and it does not require any special maintenance.

Novelty & Inventiveness

The materials used are durable and easy to use, it consists of perspex as a box model to protect the exterior of the refrigerator model. We also use cork as insulation for the refrigerator. This project also uses solar energy as a main source and IoT is applied to control the temperature of refrigerator.

1. Innovation / Product Development / Design / Process.
 - 1.1 PDCA method is use to design this project. The PDCA cycle is a continuous loop of planning (P), doing (D), checking (C), and acting (A). It provides a simple and effective approach for solving problems and managing changes.
 - 1.2 Planning (P): In this step, we used a problem statement to set up our planning of the project. We design our project based on two problems statements :
 - 1.3 If the source of electricity is not available or disconnected, it will be a problem for all consumers who have this equipment in their homes.
 - 1.4 User cannot know directly when the temperature is high
 - 1.5 Do (D): To develop the goals, we set up with the main objectives of this project:
 - 1.5.1.1 to design a model of refrigerator that uses an alternative solar energy.
 - 1.5.1.2 to control the temperature of the refrigerator using temperature sensor (DHT11).
 - 1.5.1.3 to receives a signal from the DHT11 sensor and the signal is sent to user via GSM SIM900A (smartphone).
 - 1.6 Check (C): For this step, we make sure all the components are function well. The main components in the IoT Solar Refrigerator are shown below:

Numb.	Component	Description
1.	Arduino Uno	Arduino uno is an open source electronic kit specially designed to make it easier for users to interact with various sensors and controllers. The Arduino

		Uno is a microcontroller board fully controlled by the ATmega328P (data sheet).
2.	GSM SIM900A	SIM900 GSM is a device that works to communicate between mobile phones and Arduino using GSM network. In this project, GSM SIM900A will send temperatures values via short message to the user.
3.	DHT11	Temperature / humidity of refrigerator can be read or measured and show either high or low.
4.	Solar Panel	Solar panels (known as modules or photovoltaic panels) absorb sunlight as an energy source to produce electricity or heat. It is used as a component in a larger photovoltaic system to generate electricity for commercial and residential use. In this project, we get power supply from solar panel to be use 24 hours backup.

1.5 Act (A): Lastly, we analyze what happened based on the flow chart process. We start with a source of sunlight which it emits solar to produce electricity. Next, the power supply is used to store energy, where the storage is within 24 hours. From the power supply the energy is sent to the cooling fan to blow cool air from the evaporator to refrigerator. The DHT II sensor serves as a tool to measure the temperature and humidity of the air in the refrigerator. GSM will send a short message to the user if the temperature is too high or low. User can find out the temperature conditions on their refrigerators from their phone.

2. Important to education

- 2.1 Creativity and innovation: The idea for this project is based on creativity which is translated into an innovation (renewable energy).
- 2.2 High impact: Clients (students) – fulfils clients' expectations to improve their ideas in IoT and electrical engineering.
- 2.3

3. Advantages of Innovation

- 3.1 New technology of refrigerator that use solar energy (solar panel).
- 3.2 Energy saving as well as high temperature resistance design.
- 3.3 Beneficial for improving convenience, comfort, energy efficiency uses and level of safety in the home.

4. Commercial value /marketability /profitability

- 4.1 Solar energy systems should be an option to address energy shortages and prevent global warming.
- 4.2 Easy to control, comfort and improving level of safety.

Acknowledgement

We would like to thank our supervisor, Puan Nur Filzah Binti Mohd Fauzey for the guidance and encouragement throughout the implementation of this project. This appreciation is also given to other lecturers who also have gave their great help in finishing this project. We also would like to express our deepest gratitude to our family and friends for their unfailing support and continuous encouragement.

References

- Faisal Ramadoni. (2014). Apa itu Internet of things? Retrieve from <http://teknournal.com/definisi-internet-of-things/>.
- Nur Afini (2018). Sistem Rumah Pintar Berasaskan Internet Pelbagai Perkara. Retrieve from <http://www.ftsm.ukm.my/file/research/technicalreport/PTA-FTSM-2018-118.pdf>

WIRELESS HUMANOID ROBOT USING MICROCONTROLLER “ESP32” VIA BLYNK

Mohd Faizal bin Mustapha

Politeknik Kota Bharu, Ketereh, Malaysia
mfaizal@pkb.edu.my

Muhammad Arif bin Zainudin, Wan Muhammad Afnan bin Wan Azli

Politeknik Kota Bharu, Ketereh, Malaysia
Arif.zainuddin01@gmail.com, azliafnan26@gmail.com

Highlights: The field of robotics is increasingly popular among students, including at the Politeknik Kota Bharu. Furthermore, humanoid robots are professional service robots built to mimic human motion and interaction. Like all service robots, they provide value by automating tasks in a way that leads to saving cost and productivity. Humanoid robots are a relatively new form of professional service robot. While long-dreamt about, it's now become commercially viable in a wide range of applications. The interaction between humans and robots is an important aspect to consider in the development of humanoid robots. In the mode of manual control, humans must communicate with the robot humanoid wirelessly to allow the robot to move freely. The goal of this project is to develop a humanoid robot that can be programmed from a computer using Arduino IDE software version 1.8.15. To achieve this objective, humanoid robots can be connected using Bluetooth and Wi-Fi rated at a frequency of 5 Ghz Band, a communication distance of up to 30 meters for indoor environments and up to 100 meters for open environments. microcontroller "esp32" has been selected as the robot humanoid control centre where 30 GPIO pins can be declared as output/input that will signal to the robot humanoid which is connected to other components such as servo motor, L298N, Power Supply, and others. Arduino IDE software version 1.8.15 as a compiler required to build the program before downloading the hex code into the robot humanoid control centre using the ESP32 DEVELOPMENT BOARD MODULE. The BLYNK software application allows users to send movement commands to a robotic humanoid. At the end of this study, the humanoid robot has been successfully controlled by the user by moving a joystick that includes front, back, left and right. In addition, GPIO15, GPIO2, GPIO4, GPIO16, GPIO17 are declared as outputs for servo motors. In conclusion, this study allows students to clearly see the operation of robots during the learning process and be a reference to projects involving the control of a system.

Key words : *Humanoid, Robotic, Microcontroller “ESP32” , Arduino IDE, Wireless, servo motor.*

Introduction

Robotics has become a phenomenon in engineering and manufacturing due to its ability in performing various tasks in line with the 4.0 industrial revolution. Therefore, in order to achieve as a TVET institution to fulfill the vision and mission of the Malaysian Education Development Plan (Higher Education) 2015 - 2025, students of the Diploma in Electrical and Electronics Engineering at Kota Bharu Polytechnic must take the course DEC 50122 Embedded Robotic, Humanoid Robot applied in the course to provide exposure and knowledge to students on the importance of developing robots that can perform a variety of tasks. In this subject, students will learn some basic concepts that are important for robot development such as main types of robots, microcontrollers for robot circuits, sensors to signal to robots, output devices (actuators) to enable robots to respond to the environment, design and applications. robot. Faculty of Information Technology and Science, Universiti Kebangsaan Malaysia has developed a Virtual Robot Kinematics Learning System [1] to assist in the learning process. Therefore, Humanoid Robot needs to be developed using components and materials available in the Department of Electrical Engineering (JKE) as a cost saving measure. This is because the process of purchasing new assets requires a long and complicated process. Humanoid Robot aims to develop an understanding of one of the main components of the robot to allow students to see firsthand the operation of Humanoid Robo, such as moving the wrist using a servo motor, the use of motor drivers that affect foot movement and the use of ultrasonic sensors as a response to the robot. move by detecting objects. Students can apply the knowledge by interacting with the environment and design of Humanoid Robot while studying the theory in the classroom.

Innovation Objectives

This innovative system is called Humanoid Robot with IoT concept which will be used at Kota Bahru Polytechnic, Kelantan. Humanoid Robot is an innovation that will provide new exposure and knowledge among students. Immediately, it will provide an updated or improvement in the Embedded Robotics syllabus. It is in line with the current revolution of industrial 4.0 (IR4.0).

- Increase the knowledge and skill to IoT -conceptualized robotics in nowadays
- The Humanoid robots can be versatile object is properly recognized by it.
- Teaching aids for Embedded Robotic DEC50122 practice can be provided.

Background of the study

Over the past two decades, robots have been increasingly used in the oil and gas industry, as well as the service field. For this reason, most higher education institutions introduce the subject of robotics in their study syllabuss. During the learning and teaching process (PdP), various initiatives are undertaken to attract interest and help students understand theories related to the field of robotics. Studies [2] have developed a Humanoid Robot that can be programmed through a computer that uses the Arduino IDE as a Compiler for use in the laboratory to enable students to create programs using C/C ++. This Humanoid Robot can also be developed [3] to allow students to participate in competitions while cultivating interest and increasing students' skills in the field of robotics. There is no denying that there are also studies that use Humanoid robots to find out the interests, focus and motivation of students in the classroom [4] and it is clear that it is very effectively used to enable children aged three to six years through the learning process using learning techniques while teaching [5]. For the study conducted, a Humanoid Robot was developed in which its movements were based on the use of applications used on smartphones. This Humanoid Robot communicates with the smartphone using the blynk application protocol wirelessly to allow it to move freely. The next section will discuss the production process of this Humanoid Robot starting with the mechanical design until the program is developed. The findings are also described to enable students studying the subject of Embedded Robotic to relate the theories learned to real systems.

Methodology

System Design

The overall process and signal travel for the developed study are as in Figure 1. The interface for entering commands and communication between the smartphone-Huamanooid Robot must be activated. Users can control the movement of the Humanoid Robot by moving the joystick up (forward), down (backward), left (turn left), right (turn right), Rotate 360 ° (rotate locally) or release the joystick (stop) on the blynk app.

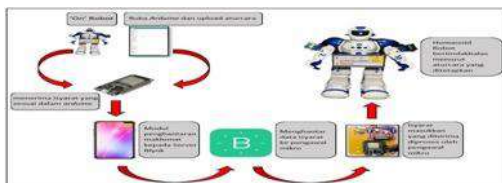

Figure 1 : System design

The program script will be written on the Arduino interface where some keyword items need to be declared due to the use of components such as servo motors that require special declarations for it to be successfully compiled. The software will analyze the written script for which there is a robot movement program. In addition, as a security measure there is an "auth token" provided to be placed in the script to prevent the occurrence of "intercept" when using blynk. The blynk application in the smartphone will be used to send instructions to the microcontroller to move the robot without using wires. The instructions received will be processed by the microcontroller to trigger the driver motor producing motion on the foot while the servo motor to move the wrist.

Mechanical Design

i. Movement of the Humanoid Robot's legs

There are two methods to trigger and navigate the Humanoid Robot namely Differential Drive and Ackermann Steering Drive. In this study, Differential Drive method was chosen to move the Humanoid Robot legs where two motors are used to control each robot wheel as shown in Figure 3. The motor to control wheel rotation is in the middle of the robot while copper -like weights are placed on the Humanoid Robot leg frame on each side to stabilize the Humanoid Robot. This design allows the rotation point of the Humanoid Robot to be between two motors.

ii. Humanoid Robot Hand Movement

The method to trigger and navigate the Humanoid Robot arm is by using a servo motor. In this study, this method was used to move both wrists where several servo motors were placed on each wrist.

Result of project

Humanoid Robot when the joystick is moved on the smartphone screen display. Tthe display on the 'terminal' joystick when it is moved up, down, left, right and released. Can be observed also if the joystick concerned is activated before the program is entered, Humanoid Robot will not react (move). Once the program is entered, the humanoid robot will

continue move guided by the instructions given. Nevertheless, sequential instructions can be given because of the Humanoid Robot only responds according to the last command prompted by the user. The resulting movement if the user move the joystick sequentially. Table 1 shows the rotation combinations motor to produce the motion of the Humanoid Robot.

Table 1 : Servomotor Rotation Combination

Motor Kiri	Motor Kanan	Pergerakan Humanoid Robot
Mengikuti Putaran Jam Dengan Kelajuan 255	Mengikuti Putaran Jam Dengan Kelajuan 255	Humanoid Robot Maju Ke Hadapan
Melawan Putaran Jam Dengan Kelajuan 255	Melawan Putaran Jam Dengan Kelajuan 255	Humanoid Robot Mundur Ke Belakang
Mengikuti Putaran Jam Dengan Kelajuan 255	Mengikuti Putaran Jam Dengan Kelajuan 100	Humanoid Robot Membelok Ke Kanan
Mengikuti Putaran Jam Dengan Kelajuan 100	Mengikuti Putaran Jam Dengan Kelajuan 100	Humanoid Robot Membelok Ke Kiri
Mengikuti Putaran Jam Dengan Kelajuan 255	Melawan Putaran Jam Dengan Kelajuan 255	Humanoid Robot Berputar Pada Titik Yang Sama

i. Politeknik Kota Bharu, JPPKK and MOHE

- To achieve Polytechnic's Malaysia KPIs towards Pelan Pembangunan Pendidikan Malaysia (Pendidikan Tinggi) 2015-2025
- Collaboration with industry and others educational institutions

ii. Lecturer

- Providing diversity in teaching aids accordingly to the current learning development through e-learning.
- Providing new technology in Industrial Revolution (IR 4.0).

iii. Student

- Adding knowledge in the embedded robotic syllabus among students.
- Teaching aids for embedded robotic practice that are latest with current technology
- Creating skilled engineering graduates in the field of robotics from TVET institution.
- Can have a more flexible learning environment anywhere as it does not require a specific place or classroom to do the practical.

Commercialisation

- This innovation project can be shared with other TVET institutions such as UTHM, UTEM, and also Vocational Colleges.
- Collaboration with industries that require the use of robotic energy such as oil & gas in hazardous areas.
- Apply in COVID19 situation such replace the human for activity in hospitality.

Suggestions For Improvements

There are some suggestions for improvements of this Humanoid Robots that it can be used more effectively. Suggestions for improvements include:

- The size can be more than that and speed of movement can be accurately
- A fixed equilibrium point to keep the robot Humanoid standing firm.

References

- Haslinda Arshad, Khor Ching Yir, Lam Meng Chun.(Aug 2012.) Journal of Convergence Information Technology(JCIT). "Virtual Robot Kinematic Learning System : A New Teaching Approach", Volume 7, Number 14.
- Thuyen Van NGO, Dong Hung NGUYEN.(2013). Proceedings of the IETEC'13 Conference, Ho Chi Minh City, Vietnam. Copyright © Authors' na Journal of Human-Robot Interaction mes "Design a Mobile Robot Operating on Linux Operational System for Educational Purposes".
- Taiser T. T. Barros, Walter Fetter Lages.(2012). 3rd International Conference on Robotics in Education. "Development of a Firefighting Robot for Educational Competitions".
- Takuya Hashimoto, Naoki Kato, Hiroshi Kobayashi .(2011). Int J Adv Robotic Sy, Vol.8, No. 3, Special Issue Assistive Robotics "Development of Educational System with the Android Robot SAYA and Evaluation", pp. 51-61.

SMART HOME AUTOMATION USING BLYNK

Muhammad Amir Syafiq bin Kamalruzzaman

Politeknik Kota Bharu, Kelantan

syafiqamir707@gmail.com

Rosmaria binti Ariffin

Politeknik Kota Bharu, Kelantan

rosmaria1979@gmail.com

Highlights: The project presents the design and prototype of a new home automation system that uses Wi-Fi technology as a network infrastructure to connect its parts. The proposed system consists of two main components, the first of which is a "server" which shows the core of the system managing, controlling, and monitoring the home. Users can remotely control the system through the use of a Wi-Fi-connected cable (internet). The second part is the hardware interface module, which provides an appropriate interface for sensors and home automation systems sensors. Unlike most home automation systems available in the market the system proposes that a server can manage many hardware interface modules as long as it exists on the range of the Wi-Fi network. The system supports various types of home automation devices such as power management components and component security. The proposed system is better from the point of view ability and flexibility of view than the commercially available home automation system.

Keyword: IOT device, smart home, internet, home automation, connected home.

Introduction (Innovation / Product development / Design / Process)

With the development of new electronic technologies and the integration of traditional building technologies, 'Smart Homes' are finally becoming a real possibility. While smart home is not a new term for society but it is still far superior from the public view. Because recently a variety of work has been done with the design and general overview of possible remote access approaches to control devices at home. This will cause negligence due to forgetting to turn off the lights and fans. Apart from that, there is a waste of maintenance costs due to damage to lights and fans as well as the cost of paying electricity bills. 'Smart Home' technology is an awareness of home automation using certain technologies. Homes that use 'android' applications are very good because the system can monitor many aspects of daily life. As the number of home-controlled appliances increase, the app's ability to connect and communicate with each other digitally becomes a useful and exciting feature. The project was developed using the ESP-32 microcontroller which is the control centre that controls the entire operation of the Smart Home. The ESP-32 microcontroller will receive a pre-programmed signal for input and send a signal to the output for each use of the input and output components on the Arduino. The Arduino must be connected to the input and output components. A port will be connected to the Arduino to be programmed on the ESP-32 to control each component job to turn on the power. Apart from that, ESP-32 will also be programmed in the use of wi-fi to control the Blynk application through the mobile phone used. To control the fan, lights and solenoids it will use a four (4) channel relay connected to each leg of the ESP-32 to transmit this signal so that it is highly capable by connecting a 12v supply to control the operation of the fan, lights and solenoids. The cost of the project is estimated at RM129.00.

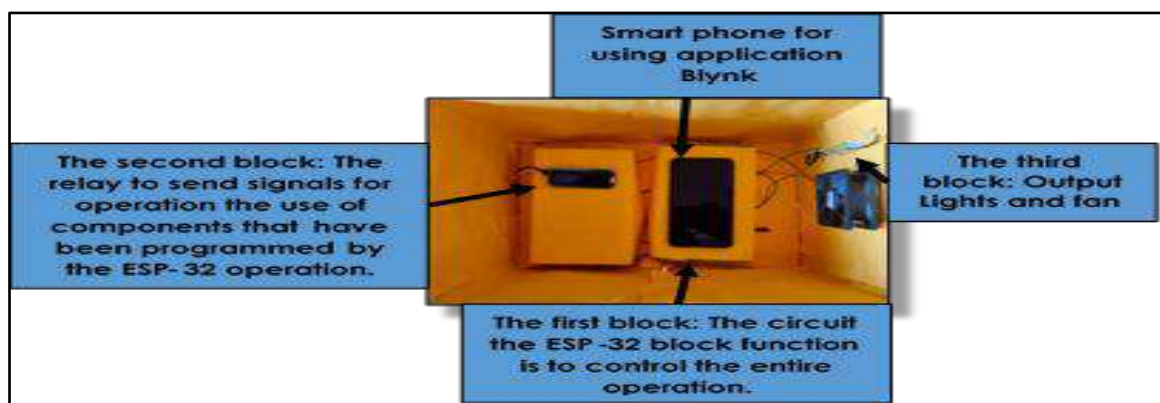

Figure 1: Design of innovation

Content

1. Description of the innovation

The project was developed using Proteus 8.5 Software as the basis in developing this Smart Home Automation Using Blynk project by creating the most efficient graphical programming for data acquisition, data analysis and data presentation. It contains a user interface known as a front panel that displays the equipment that is controlled in a

building or residence. The choice of Proteus 8.5 software is because it is software which is very effective. The Proteus 8.5 software is equipped with the application used which is Wi-Fi (Blynk) which will control all commands from the user. It facilitates the connection between the Android and ESP-32 microcontroller used in this project. With this 'Android', all user activities will be smoother and easier and it can also avoid wastage of energy.

2. Background Of the Innovation

Smart Home Automation Using Blynk can benefit organizations and customers. In addition, it can prevent the negligence and safety of users in the organization or residence. This innovation project facilitates users in the use of electronic devices such as fans and lights in organizations or homes where it saves time and energy of users because the project operates automatically and does not need to be operated entirely by humans. In addition, it can save costs by optimizing the use of available resources. These innovation projects have the potential to adapt directly or indirectly according to the needs of the organization or other institutions.

3. Important to education

The idea for this project is based on creativity that translates into innovation that benefits the end user, i.e. the user in the organization or residence. Smart Home Automation Using Blynk is able to meet customer expectations to facilitate daily affairs today in the organization or residence. With the help of these smart features as well, security is increasingly assured and part of the expenses in the organization or residence can be reduced gradually like electricity bills. The impact of IoT technology in maintaining an efficient and viable education system. Technology experts unanimously state that learning using high quality online content such as e-learning is able to offer a variety of facilities and information that benefit students and educators.

4. Advantages of your innovation

This innovation project provides many benefits to consumers in organizations or homes. Among the benefits is to avoid safety negligence and provide convenience to users in the use of electronic devices such as fans and lights in the organization / residence. Smart Home Automation using Blynk can reduce manpower consumption by using a smartphone to turn off lights or fans. In addition, it can save time and energy users because this project operates automatically and does not need to be completely controlled by humans. The system is also easy to operate and in the event of a breakdown, it is easy to repair.

5. Commercial value /marketability /profitability

With this innovation project, smart home technology can be shared and disseminated to the general public. This project can also be applied in institutions of higher learning and can meet the needs of the modern way of life in Malaysian society. The project also has the potential to be commercialized for all users by operating the equipment using Smart Home Automation technology via a mobile phone or tablet android system.

References

- Adamu S. Kadalla, Ahmed I.Tijjani, Matthew K. Luka. (2016). Android Based Smart Home System. 3rd International Conference on African Development Issues (CU-ICADI 2016), 115 - 119.
- Imran, Vignesh.S.S, Singh.J, Prasath.V.K. (2016). Smart Home automation based on IoT using Arduino mega. Article An IoT-Based Smart Home Automation System, 1- 23.
- Stolojescu-Crisan, Crisan.C, Butunoi.C. (2021). An IoT-Based Smart Home Automation System. Sensors 2021, 21, 3784. <https://doi.org/10.3390/s21113784>.

IoT-BASED NON-INVASIVE BLOOD GLUCOSE MONITORING SYSTEM

Lim Shau

Faculty of Electronic Engineering Technology, Universiti Malaysia Perlis, Arau, Malaysia
s171233190@studentmail.unimap.edu.my

**Ts. Dr. Siti Zuraidah Ibrahim, Ts. Dr. Ku Nurul Fazira Ku Azir, and
Assoc. Prof. Dr. Ruzelita Ngadiran**

Faculty of Electronic Engineering Technology, Universiti Malaysia Perlis, Arau, Malaysia
sitizuraidah@unimap.edu.my, fazira@unimap.edu.my, ruzelita@unimap.edu.my

Highlights: This innovation is an IoT-based non-invasive blood glucose concentration (BGC) monitoring system that uses near-infrared sensors (NIR) to detect blood glucose levels through fingers scanning and record the results in the cloud. The designed system consists of LED emitting signals that are sent through the fingertip and reflected signals are detected by phototransistor placed beside the LED. The glucose concentration in the blood is determined by analysing the variation in the intensity of received signal obtained after reflection. Results of the experiments proved that the device is reliable in glucose detection with 1.13% - 16.41% accuracy.

Key words: Blood Glucose, Diabetes, Near Infrared, Non-Invasive.

Introduction

In Malaysia, it is estimated that 3.9 million (18.3%) of the adult population had raised BGC in 2019 (Wan, K. S., Hairi, N. N., Mustapha, F. I., Yusof, K. M., Ali, Z. M., & Moy, F. M. (2021)). The most widely available way of reliably measuring BGC is by pricking the finger to get a few drops of blood. If the needle is contaminated or used more than once, this procedure is invasive, painful, and can cause users to be infected. The test strips are disposable and extra costs will be applied. Therefore, in this innovation, we proposed a sustainable non-invasive monitoring system that avoids the risk of infection problems and pain caused by invasive monitoring techniques. In addition, it can be used frequently without spending money on disposable strips. This is more demanded during Covid-19 outbreaks where the risk of infection should be minimized to control the spread of the virus.

Content

This work presents a method for developing a non-invasive technique to predict the BGC based on the NIR light sensor. The prototype of a non-invasive blood glucose monitoring system is shown in Figure 1.

Figure 1: The prototype of non-invasive BGC monitoring system

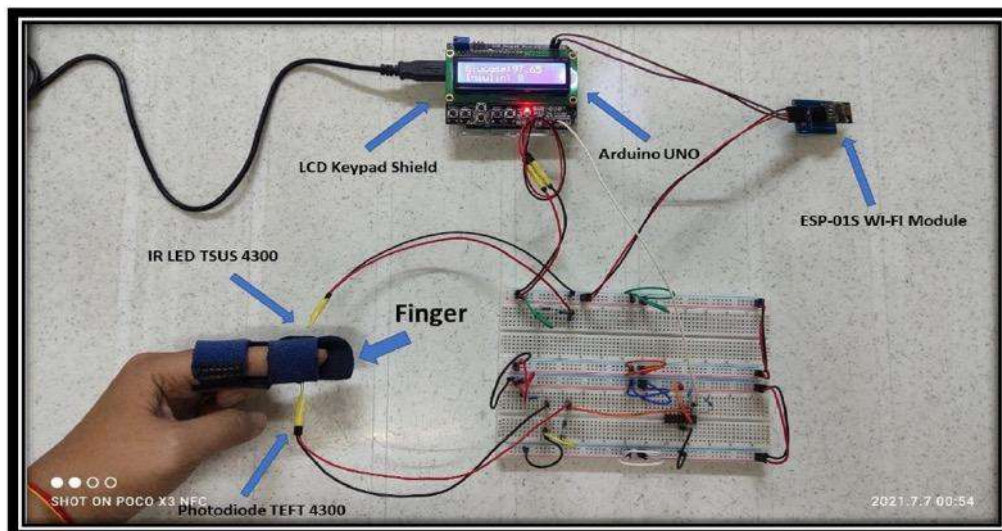

The prototype was developed using an LED-based finger sensor to collect photoplethysmography (PPG) signals, which vary depending on the variance of glucose concentration. The TSUS 4300 infrared emitting diode, 950 nm wavelength Gallium Arsenide (GaAs), is used as the transmitter. The LED emitter signal is sent through a fingertip and the reflected signal is detected by a phototransistor placed next to the LED. The photodiode, TEFT 4300 is suitable for use with TSUS 4300 because it has a wavelength sensitivity of 800 nm-950 nm, similar to IR LED TSUS 4300. Blood glucose concentration is determined by analysing the intensity variation from the received signal obtained after reflection. The module circuit for pre-processing the PPG signal is realized, which includes an amplifier and analog filter circuit, Arduino UNO is used for analog-to-digital conversion. The data shown on the LCD display includes the patient's body mass index (BMI) calculated based on the weight and height values entered, the measured BGC values and the required insulin dose. This data is then sent to the cloud via a Wi-Fi module, which can then be viewed using a laptop or mobile tablet.

In order to determine whether this technique has promised accuracy or not, TEN (10) fingertip scanning are performed, and its result are compared with the invasive prick method using commercialized glucometer Accu-Chek Instant-S. The comparison results are shown in Table 1. As shown in Table 1, the percentage error for a glucose measurement obtained using the designed method against the prick method is less than 16.41%, and the average percentage inaccuracy is 8.40%. However, if additional tests are included in the dataset, the average percentage error may be reduced even further.

Table 1: BGC readings comparison between commercialized glucometer and this innovation

Subjects	Glucose concentration measurement (mg/dL)		Percentage difference (%)
	Accu Check	NIR Sensor	
1	132	110.33	16.41%
2	115	109.46	4.81%
3	124	121.79	1.78%
4	123	110.67	10.02%
5	124	111.54	10.04%
6	126	124.57	1.13%
7	121	106.68	11.83%
8	112	125.44	12.00%
9	114	102.16	10.38%
10	95	103.55	9%
Mean	118.6	112.619	8.40%

This prototype has great potential to track the health of patients, in turn, maintaining their blood glucose levels on a regular basis. IoT innovation enables healthcare professionals or caretaker to be more watchful and connect with the diabetic patients proactively. Data collected from IoT devices can help others to identify the best treatment process for diabetic patients and reach the expected outcomes, mainly during the outbreak of Covid19 pandemic. Internet of things (IoT) healthcare market is expected to gain market growth in the forecast period of 2020 to 2027 (Ansari, S., Aslam, T., Poncela, J., Otero, P., & Ansari, A. (2020)). Current invasive BGC monitoring devices require the purchase of expensive test strips whereas this innovative product does not require the use of test strips, thus saving money and having a higher commercial value in the long run.

References

- Wan, K. S., Hairi, N. N., Mustapha, F. I., Yusof, K. M., Ali, Z. M., & Moy, F. M. (2021). Predictors of glycosylated haemoglobin A1C trend among type 2 diabetes patients in a multi-ethnic country. *Scientific reports*, 11(1), 1-13.
- Ansari, S., Aslam, T., Poncela, J., Otero, P., & Ansari, A. (2020). Internet of Things-based healthcare applications. In *IoT Architectures, Models, and Platforms for Smart City Applications* (pp. 1-28). IGI Global.

RISK MITIGATION FOR SOFTWARE ANTI-AGEING DURING ANALYSIS OF CHANGES IN SOFTWARE MAINTENANCE

Noraini Che Pa

Department of Software Engineering and Information System
norainip@upm.edu.my

Thamaratul Izzah Binti Azman, Yusmadi Yah Jusoh and Rozi Nor Haizan Nor

Faculty of Computer Science and Information Technology,
Universiti Putra Malaysia, Serdang, Selangor, Malaysia
eizahazman@gmail.com, yusmadi@upm.edu.my, rozinor@upm.edu.my

Highlights: Software ageing is inevitable, however, it can be delayed. Frequent changes during software maintenance may lead to software ageing. The study aims to determine the risks of performing software changes that influence software ageing and develop a model of software anti-ageing using risk mitigation. A survey result shows that human risk, technical risk, environment risk, technology risk, maintenance procedure, and process risk have a significant effect on software ageing. The model was validated by experts. The findings contribute to assisting software practitioners to monitor, evaluate and manage the risk of software changes to achieve software anti-ageing.

Key words: Risk Mitigation, Software Anti-Ageing, Software Ageing, Software Maintenance

Introduction

Generally, software ageing is regarded as the degradation of software performance and quality to operate and provide services (Abidin et. al., 2018). Hence, it is important to counteract software ageing because it does not only contributes to negative effects on software but also gives issues to the users and their environment. According to Ahamad (2016), effects of ageing may cause difficulties to cope with business operations leading to delayed work, schedule and economic disruption. In software engineering, ageing could be prevented through managing, evaluating, and monitoring the impact of software changes (Russo, 2014). Hence, the purpose of the research is to provide insight in preventing ageing occurrences from software change to maintain software quality.

Content

The study had determined the risks of performing software changes and further built a model as guidance to mitigate those risks. The model is developed based on literature review, empirical study and was validated by using an expert or accreditation approach through interviews. It comprises five components such as change request, risks of software changes to software ageing, risk mitigation process, and software anti-ageing. The model is applied whenever there is a change request to fix the error or enhance software functionalities. Five risk dimensions of software changes that influence software ageing shall be used as an input for the risk mitigation process. The process is applied as a strategic approach in minimizing the effect of software changes that influence ageing progress through identifying probable risks, estimating risk exposure, providing a suggestion for risk treatment, and monitoring the residual risks. In the end, the mitigated risks shall maintain the software state to remain anti-ageing.

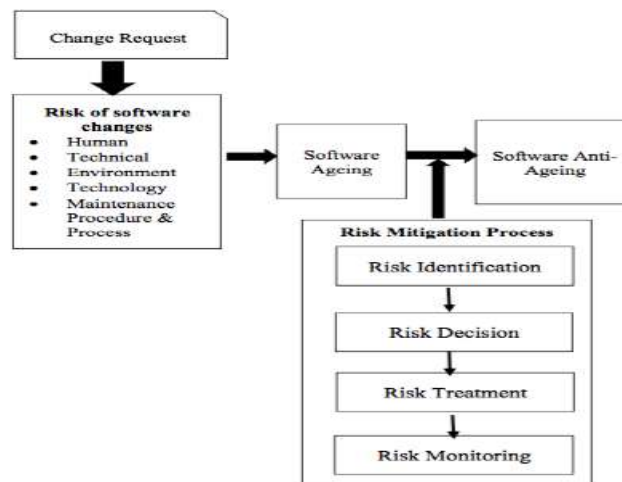

A Model of Software Anti-Ageing using Risk Mitigation

Continuous change during maintenance deteriorates software structure, which possesses threats to its quality leading to ageing (Catolino et. al., 2018). Analyzing the risk of these changes helps to minimize its impact before changes are implemented, however, it is still uncertain how maintainers perform an assessment of risks during change analysis (Russo, 2014; Rahman et. al., 2019). Moreover, the existing software anti-ageing model provides inadequate support to determine the impact of software change. Particularly, software anti-ageing is software that maintains the high quality that enables it to stay relevant within its environment (Abdullah et. al., 2019). Therefore, such gaps motivate the study to propose a model of risk mitigation for software anti-ageing.

The findings from this research are important as guidance for maintainers in providing better understanding and knowledge to mitigate risks that influence ageing manifestation during change analysis in software maintenance. It eases decision-making through a quantifiable and scalable risk mitigation process to support change analysis.

The advantages of this research towards the community are: (1). to guide maintainers in mitigating risks of software changes during change analysis in software maintenance to achieve software anti-ageing and to examine the impact of identified risks for preventing poor decision-making; (2). to assist software developers in ensuring that the software development process can consider changes on the needs requested by customers and at the same time be able to maintain the quality of software; and (3). to allow the software to be used in the long run considering repairs to any defects.

The commercial values of this research are: (1). to aid the software industries and government organizations for software maintenance; (2). to provide more understanding of risk report that provides maintainers with the exact value of risk exposure, refrains them from misunderstanding or misinterpretation; and (3). to help in managing and executing the risk mitigation process.

Acknowledgment

This work was supported by Universiti Putra Malaysia under Putra Graduate Initiative Grant, (GP-IPS/2018/9644600).

References

- Russo, S. (2014). The Dual Nature of Software Aging: Twenty Years of Software Aging Research. In 2014 IEEE International Symposium on Software Reliability Engineering Workshops. 431-432. IEEE.
- Rahman, M. A., Razali, R., & Ismail, F. F. (2019). Risk Factors for Software Requirements Change Implementation. *International Journal of Advanced Computer Science and Applications*
- Abdullah, Z. H., Yahaya, J., Ibrahim, S. R. A., Fadzli, S., & Deraman, A. (2019). The implementation of software anti-ageing model towards green and sustainable products. *International Journal of Advanced Computer Science and Applications*, 10(5), 42-50.
- Abidin, Z. N. Z., Yahaya, J. H., Deraman, A., & Abdullah, Z. H. (2018). Rejuvenation Action Model for Application Software. In 2018 6th International Conference on Information and Communication Technology (IColCT), 38-43. IEEE.
- Ahamad, S. (2016). Study of software aging issues and prevention solutions. *International Journal of Computer Science and Information Security*, 14(8), 307-313.
- Catolino, G., Palomba, F., De Lucia, A., Ferrucci, F., & Zaidman, A. (2018). Enhancing change prediction models using developer-related factors. *Journal of Systems and Software*, 143, 14-28.

HUMAN ELEPHANT CONFLICT RECORD (HECoR) APP

Hazizi Husain

PERHILITAN Negeri Kelantan
hazizi@wildlife.gov.my

Kamarul Ariffin Kambali@Hambali, Norashikin Fauzi

Universiti Malaysia Kelantan, Jeli Campus, 17600 Jeli, Kelantan
kamarul@umk.edu.my, ashikin@umk.edu.my

Highlights: This article highlights on an effective app for digitise data entry on the human elephant conflicts (HEC). This innovation known as Human Elephant Conflicts Record or HECoR is meant to introduce a smart and modern way of recording the details of incident occurring on the site. All the data recorded on this portable app will be saved in excel and accessible to the entire person in charge in dealing with HEC.

Key words: *smart modern recording, human elephant conflicts, HEC, HECoR*

Introduction

Human elephant conflicts (HEC) results in both elephants and humans suffering; it results in the loss of human lives, loss and damage of crops and property for humans; and for elephants it involves loss of life, injuries and loss and degradation of habitat. The need for baseline data on populations and habitat, for cross-sectoral information sharing and for specific information on population and habitat viability and on genetics are vital in managing the HEC.

In recent years, technological innovations like camera traps and GPS collars have revolutionized elephant research. However, when it comes to collecting field observations, wildlife rangers frequently still use the old-school method of a pen and a notebook. Conducting surveys in remote areas such as in the indigenous people villages or natural areas and then digitizing and processing survey data can be challenging and time-consuming.

This practice could be improved by innovating a holistic solution to help circumvent some typical challenges associated with old-fashion methods, such as typos, transcription errors and incorrect dates and times.

Content

1. Description of product development.

Human Elephant Conflicts Record or HECoR app is developed to avoid wasting time on data entry, losing valuable descriptive data and assist in instant monitoring of HEC through online sharing data.

This app helps users manage data sent from the field, conduct basic data analysis or export data to more sophisticated analytical tools. The data can be viewed as an Excel spreadsheet. The information such GPS locations, captured images and details of morphology of the elephants could also be saved and shared by the users particularly in Unit Tangkapan Gajah (UTG) PERHILITAN.

2. The importance of product development.

Through this development of HECoR app:

- i. Digitizing data collection by using HECoR app helps circumvent some typical challenges associated with old-fashion methods, such as typos, transcription errors and incorrect dates and times.
- ii. Moreover, the app is more time-efficient; data can be exported easily and quickly into a database, a big improvement on traditional methods that required manual entry from field notes.
- iii. The monitoring and identifying the locations of HEC could be done in a convenient way.

3. Advantages of the product development towards education and community.

- i. These forms enable field researchers who greatly involve in HEC study to conduct their surveys digitally, using a mobile phone, allowing them to spend less time collecting and compiling information and more time analyzing it.
- ii. To facilitate the flow of information between remote communities and UTG staff (PERHILITAN).

4. Commercialization potential of the product.

- i. PERHILITAN
- ii. Research institution
- iii. Remote communities

Acknowledgement

We would like to thank you to PERHILITAN and Faculty of Earth Science, UMK for supporting our journey in promoting smart technology in developing a smart HECOR app.

References

CITES MIKE www.cites.org/eng/prog/MIKE

Desai A.A., 1998. Technical Report: Management Strategies for the Conservation of Elephants and Mitigation of Human-Elephant Conflict. FAO, Colombo, Sri Lanka.

INTELLIGENT SPECTACLE FOR BLIND PERSON

Anuar Bin Mohamed Kassim

Universiti Teknikal Malaysia Melaka, Hang Tuah Jaya, 76100 Durian Tunggal Melaka, MALAYSIA
anuar@utem.edu.my

Muhammad Herman Bin Jamaluddin, Arman Hadi Bin Azahar, Mohd Rusdy Bin Yaacob, Sivarao A/L Subramonian, Albert Feisal @ Muhd Feisal Bin Ismail, Md Nazri Bin Othman, Muhammad Fahmi Bin Miskon, Ahmad Zaki Bin Shukor, Muhammad Mustaqiim Bin Roslan, Sahrul Bin Sahak, Nurul Nadia Binti Ayob, Muhammad As Shakirin Bin Abdul Aziz, Awangku Khairul Ridzwan Bin Awangku Jaya

Universiti Teknikal Malaysia Melaka, Hang Tuah Jaya, 76100 Durian Tunggal Melaka, MALAYSIA
AURO Technologies PLT, Ayer Keroh, Melaka, MALAYSIA
anuar@utem.edu.my, auro@aurotechsolutions.com

Highlights: Conventionally, most visually impaired persons (VIPs) are using white cane for travelling. For VIPs, there are two areas that need protection. These obstacles such as open window, signboard and etc. It's very important to have protection for the head level. Therefore, a new intelligent travel aid device has been developed. The designed prototype imitate the spectacle used by the VIPs called i-SPEC, the future of vision that filled with smart sensors to detect obstacles by applying the non-contact approach. This product can be used for various types of VIPs with different warning types such as light for partially blind, audio, and vibration for a fully blind and deaf-blind person. As result, the i-SPEC is in TRL7. Finally, the i-SPEC is truly believed that can improve the mobility of the VIPs and increase the quality of life.

Key words: *intelligent spectacle, wearable device, travel aid, visually impaired person*

Introduction

The World Health Organization (WHO) has released statistics on People with Disabilities (PWDs) globally estimated more than 15% of the world's population. From these statistics, the VIPs are 285.4 million people, where China and India got the highest population of VIPs. From the statistics in Malaysia the actually data, only 300 thousand registered as disabilities. And from there, there is around 48 thousand are VIPs. Actually everyone can be blind at any time. Sometime started from baby, acute diabetes (glaucoma), and cataract. Imagine, what happen if it suddenly happened to us. It is very hard to accept and to adapt with the new condition.

Conventionally, most VIPs are using white cane for travelling. However, white cane has a limited access range because the white cane can only detect the obstacle below the abdomen level. For the VIPs, there are two areas which need to be protected. Therefore, if there is any obstacle which is above their abdomen level such as at the head level. They can have a collision. White cane cannot protect the user from collision with the obstacle at a head level such as propped open window, tree branch, back stair and rear truck. Its very important for them to have the protection for the head level. From the survey, 300 blind people expert in using long cane have experience collision with head-level obstacle. 39% of respondent experienced head-level accident once a year & 14% of respondent more often than once a month.

Therefore, the usage of spectacle type obstacle detection system will help them to scan the surrounding especially for the upper body level from encountering head level collision. The design and implementation of the spectacle based obstacle detection system is the focus of this paper. Four pieces of distance measurement sensor are proposed in the travel aid in order to detect obstacles in each direction, such as front, down, left and right. If the distance measurement sensors detect an obstacle, the warning system will be activated and a warning signal about the location of the obstacle will be given to the user.

The warning devices that are designed and implemented in the system are audio and vibration warning systems. The usage of both warning devices can be switched to either as a single headphone audio or a vibration warning device depending on users' preference and environment. For example, if the user enters into a crowded environment such as marketplace or bus terminal, they are recommended to change and use only the vibration warning device, whereby their stereo hearing sense will be used to capture the sounds around them. An evaluation on the developed electronic spectacle was also done in order to produce an effective, reliable and light wearable device.

Product description

Previously, the development of travel aid device to assist the visually impaired persons to travel alone has been conducted (Kassim et al., 2011). This study is based on statistical studies by the World Health Organization (WHO) statistics and a collaboration study with the Society of Blind Malaysia (SBM) including Malaysia Associated of Blind (MAB) regarding the major problems faced by visually impaired persons in Malaysia. From the interview session, the visually impaired persons normally face difficulties when they travel alone without any guidance by helper or guide dogs. The basic problem that is always faced is obstacle detection and avoidance in order to travel and reach a destination safely. Severe accident and injury can be caused by accidental fall and collision with obstacles. Therefore, some concepts need to be understood and fulfilled in order to design and develop the travel aid suitable for the visually impaired persons. The technology requirements that need to be fulfilled include real

time guidance, portability, power limitation, appropriate interface, continuous availability, no dependence on infrastructure, low cost solution and minimal training (Anuar et al., 2015). By fulfilling these entire requirements, the visually impaired person can travel independently without depending on human or guide dogs and the accidental rate can be reduced.

Therefore, to overcome such problem, a new intelligent travel aid device has been developed after conducting some surveys, prototyping, and development. The designed prototype imitates the spectacle used by the VIPs which is called i-SPEC, the future of vision. i-SPEC stands for "intelligent spectacle" that filled with smart sensors. The smart sensor concept is applied by using ultrasonic sensor which applying non-contact approach. In the ISPEC, there are 2 pieces of ultrasonic sensor used to detect front, top, left and right which detection angle at 150 deg. Even though the sensor can detect up to 6 meters, the detection range are set started from 1.5m determined from the survey done with the VIPs.

On the other hand, the battery can be rechargeable easily using USB docking charger. The battery capacity can be checked when user switch ON device where 100% : 3 beeps, 70% : 2 beeps, 30% : 1 beep 0% : no beep. This product also can be used for various type of VIPs such as fully blind, partially blind and multi-disabled such as deaf-blind person. Each of the categories has different type of warning such as light for partially blind, audio and vibration by using the bone conduction speaker for fully blind and deaf blind person. By using the bone conduction speaker, the user also can hear the environment surround without putting the headphone into the ear.

We also have done a test with the hanging obstacle. The path of the user is captured by using the laser ranging finder and the result shown as in the video. From this result, the intelligent spectacle able to detect and give warning to the user the obstacle is. The paths that has been recorded shown as in result where the obstacles are successfully avoided by the user. The result from the sensors and the warning signal that given to the warning device such as LED, bone conduction speaker is shown as the Figure 1.

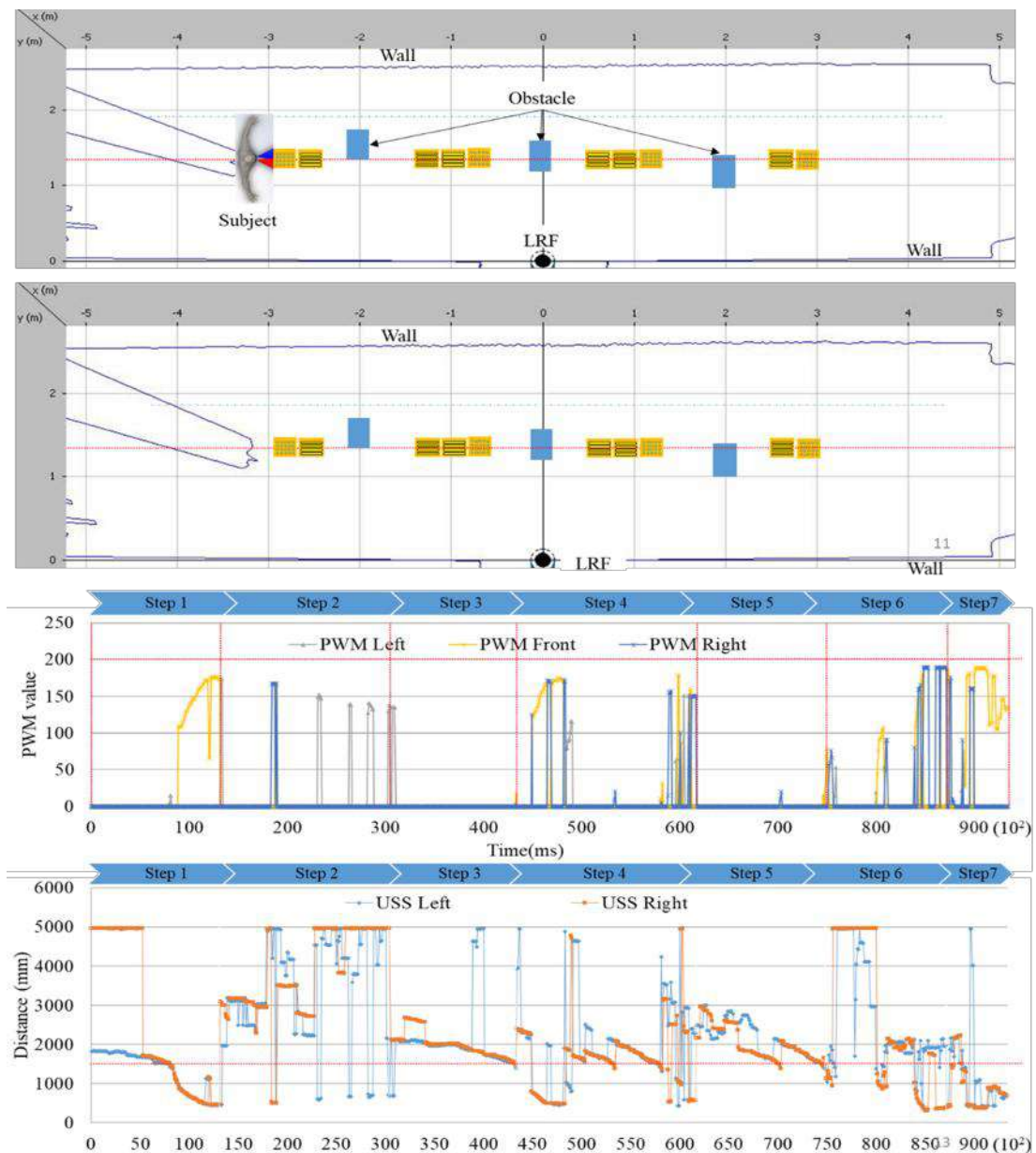





Figure 1 Experimental result for warning signal from various type of alert

Commercial viability

For technology readiness level, the i-SPEC currently where the integrated pilot system is demonstrated. To market i-SPEC, there are two marketing strategies by direct selling for the affordable VIPs through online such as Shoppe, Lazada, Amazon, eBay, Alibaba and etc. beside the pharmacy such as Watson, Guardian, Cosway and etc. Besides, the indirect strategies for the non-affordable VIPs such as government initiatives, corporate social responsibilities(CSR), and non-profit government organizations(NGO). The competition matrix of this product can be shown such as following Table 1.

Table 1: Competition matrix

Photo				
Name	i-SPEC	Bionic Spectacle	Supersonic Ring	Blind stick
Features	Detect upper body obstacle User friendly Rechargeable	More function and accurate More battery capacity	Easy to use Cover lower body level	Limited access Detect lower body obstacle
Size	Small	Medium	Small	Big
Distance coverage	1.5 m	5 m	1 m	0.5 m
Alert system	Yes	No	Yes	No
Cost	RM 800	RM 2000	RM1000	RM 150

Previously, i-SPEC has been sponsored by Standard Chartered under the CSR program to deliver to the VIPs and launched by Tan Sri Muhyiddin Yasin. The i-SPEC has patent file with no. PI2012003042 and industrial design filed no. 13016000101. Some publications in the journal and conference also conducted and received some awards from Institute of Electrical Engineer Japan(IEEJ) and recent awards are from Takeda Foundation, Japan for Young Entrepreneur Award along with Asia Pacific ICT Award(APICTA) and Start-up Business Plan Challenges by MDEC.

Intellectual properties

For this product, there are several intellectual properties which has been filed and granted. The intellectual properties are such as Patent, Industrial Design and Copyright. For the patent, the patent no is PI 2012003042: A system for alerting of a motion of a person. Meanwhile, the industrial design is 13-01600-0101 (Class 16-06) titled SPECTACLE that has been granted and finally the copyright titled Intelligent wearable device for visually impaired person.

Acknowledgement

This project is fully funded by collaboration research between Universiti Teknikal Malaysia Melaka and Ministry of Higher Education Malaysia under Prototype Research Grant Scheme no. PRGS/2019/FKE-CERIA/T00022.

References

- Acoustical Society of America (ASA), (2012) "Blindness may rapidly enhance other senses.", Science Daily, 8 May 2012. www.sciencedaily.com/releases/2012/05/120508152002.htm.
- A.M Kassim, Jamaluddin, M.H., Yaacob, M.R., Anwar, N.S.N., Sani, Z.M. and Noordin, (2011) A, Design and development of MY 2nd EYE for visually impaired person, Proceeding of IEEE Symposium on Industrial Electronics and Applications(ISIEA),, pp.700–703.
- A.M Kassim, M.S Jamri, M.S.M Aras, M.Z.A Rashid and M.R Yaacob, (2012) Design and development of obstacle detection and warning device for above abdomen level, Proceeding of 12th International Conference on Control, Automation and Systems (ICCAS), , pp.410–413.
- A.M Kassim, H. I Jaafar, M.A. Azam, N. Abas and T. Yasuno(2013), Performances study of distance measurement sensor with different object materials and properties, Proceeding of 3rd IEEE International Conference on System Engineering and Technology (ICSET), pp.281–284.
- Anuar bin Mohamed Kassim, Takashi Yasuno, Hazriq Izzuan Jaafar, Mohd Shahrivel Mohd Aras, Norafizah Abas, (2015) Performance Analysis of Wireless Warning Device for Upper Body Level of Deaf-Blind Person, SICE Annual Conference 2015, No.196, pp.341-346, Hangzhou, China, July 28-30.
- Bousbia-Salah, M. Redjati, A., Fezari, M. and Bettayeb, M., (2007), An ultrasonic navigation system for visually impaired people, IEEE International Conference on Signal Processing and Communications (ICSPC), pp.1003–1006.
- R. Manduchi and Sri Kurniawan, Mobility-Related Accidents Experienced by People with Visual Impairment, Research and Practice in Visual Impairment and Visually impairedness, Vol. 4(2), (2011), pp.1–11.
- S. Shoval, J. Borenstein, and Y. Koren, Auditory guidance with the NavBelt-A computerized travel air for the visually impaired, IEEE Trans on Systems, Man, Cybernetics, Vol.28, No. 3, (1998), pp.459–467.
- S. S. Santhosh, T. Sasiprabha, and R. Jeberson, BLI-NAV embedded navigation system for visually impaired people, Recent Advances in Space Technology Services and Climate Change (RSTSCC), (2010), pp.277–282.
- World Health Organization and the World Bank Group, Disability - a global picture, World Report on Disability 2011, Chap. 2, p.29.

IoT BASED INTELLIGENT FIRE ALARM SYSTEM (I-FAST)

Anuar Bin Mohamed Kassim

Universiti Teknikal Malaysia Melaka, Hang Tuah Jaya, 76100 Durian Tunggal Melaka, MALAYSIA
anuar@utem.edu.my

Muhammad Mustaqim Bin Roslan¹, Muhammad As Shakirin Bin Abdul Aziz¹, Muhammad Muslim Bin Mohd Rashidin¹, Muhamad Afiq Shahmi Bin Shamsul Izran¹, Sahrul Bin Sahak¹, Muhammad Malek Faizal Bin Mohammad Zaini¹, Awangku Khairul Ridzwan Bin Awangku Jaya²

¹Universiti Teknikal Malaysia Melaka, Hang Tuah Jaya, 76100 Durian Tunggal Melaka, MALAYSIA

²AURO Technologies PLT, Ayer Keroh, Melaka, MALAYSIA

anuar@utem.edu.my, auro@aurotechsolutions.com

Highlights: Conventionally, the detection and notification of the fire accident is based on the siren which triggered by the fire alarm system. However, this system need human to call the fire station to come and need the fire location. Therefore, Intelligent Fire Alarm System are highly demand. The Intelligent Fire Alarm System is a product which can send the location and the time occurred to the fire station and the owner automatically without any human intervention. This product is generated by using smart sensor system, GPS and the artificial intelligence to identify and notify effectively. The IoT system are integrated with the Intelligent Fire Alarm System to ensure the air quality can be monitored by the owner and the fire station. This product can be used by the commercial building and the domestic ensure the safety and smart cities can be realized.

Key words: *intelligent fire alarm system, fire mode, gas, smoke, heat, internet of things*

Introduction

Fire structs rural areas frequently causing large value of losses, it is recorded that solely in Malaysia, After the movement protection order was issued on March 18, 2020, there have been 15,393 fires. Open fires accounted for nearly 46% (7,032) of the total, while structural fires accounted for 1,955 of the total, causing damage to buildings and other smaller structures. Most domestic fires happen to late alert from the victims, by that the fire department will face severe fires as it was not handled early. The triangle depicts the three components that must be present for a fire to start: heat, fuel, and an oxidizing agent (usually oxygen). If all the elements are present and in the proper proportions, a fire will inevitably occur.

By that, an Intelligent fire alarm system is in demand to notify the locals for prevention and fast response as fire has occurred. Ideally by reducing human intervention in detection and alerting the fire brigade. Besides, the fire detection system with a multi-criteria alarm algorithm and multi-component sensor system has to be implemented to reduce the number of false alarms caused by individual fire detectors, as well as the time it takes for a fire to be detected. A method for reducing or eliminating the number of false alarms caused by automated fire detectors.

Product description

Therefore, Intelligent Fire Alarm System (i-FAST) are highly demand to simplified the flow of notifying the fire station. The Intelligent Fire Alarm System (i-FAST) is a product which can identify the type of danger such as flammable gases, smoke, fire and extreme heat just in one simple and compact device. The Intelligent Fire Alarm System consist of both hardware and software architecture to fulfil its function. As a fire event or dangerous condition occur, the sensor will pick up abnormal readings whereby utilizing the selection algorithm, the device will select the suitable action to prevent or to stop the current event. Consisting of air quality, flammable gaseous, heat and flame sensors. The device will notify either the closest fire station dashboard or the owner informing the inconvenience condition. For less severe conditions, the device will notify locally by utilizing the LED lights and its internal piezo buzzer.

The communication method used for internet of things the device is through both Bluetooth 5.0 BLE and 2.4 GHz Wi-Fi communication. By having access to the internet, the device is programmed to function over a single web application, which is the Main dashboard hub. The owner of the device will also be notified through Telegram API bot. For each fire station, a designated dash-board with the ma of its covered range will be displayed using the Google Map API. Each device will update its location to the dashboard, geolocation reading is obtained using a Gy-Neo6m GPS module, giving its Longitude and Latitude of the device.

The architecture of the system is implemented by both internal and external of the device. The internal program has the routine to check the status of each sensor values. The threshold will determine the abnormal readings from the sensors, there are 2 possibilities which is either sensor problems or abnormal status. These abnormal statuses will be counted as data to be processed through the selection algorithm, this algorithm will form the readings of the sensors and buttons in an array form, sorted based on its reading. The array sequence will be identified, and the action will be taken based on the array sequencing code.

The device uses an API designed to update the GPS, Sensors, and button status to the dashboard. The dashboard is designed for local fire stations coverage radius, this dashboard uses the Google map API to locate and mark-up the location of the alerted device. For early preventions, Sensor reading with insufficient proof of fire, will only notify the owner and the locals though telegram and local alarm and LED flashes. The accuracy of the

smart sensor also high and will detect the particular danger very fast. After detecting the type of danger, the Intelligent Fire Alarm System (i-FAST) will send the location and the time occurred to the fire station and the building owner automatically without any human intervention shown in Figure 1. The Internet of Things (IoT) system are integrated with the Intelligent Fire Alarm System (i-FAST) to ensure the fire status can be monitored by the building owner and the fire station. The alert system also will be notifying to the fire station through website based dashboard such as illustrated in Figure 1. This product can be used by the commercial building and the domestic ensure the safety and smart cities can be realized.







Figure 1 Developed hardware and software for IFAST

Commercial viability

The commercialization potential of this intelligent product will be done through Ministry of Housing and Local Government with Fire and Rescue Department of Malaysia. On the other hand, there are others market such as residential and the industry which need frequent monitoring and the users that frequently travel and left their properties. The comparison matrix of IFAST can be shown in Table 1.

Table 1: Competition matrix

Photo				
Name	iFAST	Securistar MCD573X	Tuya Smart Home Gas Detector	Xiaomi Mijia Honeywell Fire Alarm Smoke Detector
Gas sensor	Yes	No	Yes	Yes
Fire sensor	Yes	No	No	No
Heat sensor	Yes	Yes	No	No
Smoke sensor	Yes	Yes	No	Yes
GPS coordinate	Yes	No	No	No
IoT dashboard	Yes	No	Yes	Yes
User notification	Yes	No	Yes	Yes

Intellectual properties

The technology readiness level for this product is in TRL 5. Where the small scale of prototype system was verified. In term of intellectual properties, this product has been registered under statutory of declaration of copyright and the copyright by MY.I.P.O. The registered copyright number is LY2021W00464.

Product impact

As a conclusion, the multi-sensor built in this system was designed and integrate with IoT in this project. The developed system can be used as a basis for a fire alarm system when more sensor devices are connected to the system. Besides, the developed system also can be used to monitor the condition of the monitored area and a suitable approach can be created for the controls in future if necessary. It was also important to be able to store and set sensor values related warning messages. The parameter monitoring user interface and mapping interface design to ease the fire fighter to understand the condition of fire and the rate of severeness. Some analysis framework proposed also help fire fighters to make decision in future prevention steps.

Acknowledgement

This project is sponsored by Commercialization Centre of Universiti Teknikal Malaysia Melaka. On the other hand, this product also sponsored by the Structural Entrepreneurial Incubation Program (SEIP) under Ministry of Higher Education Malaysia and Malaysia Social Innovation Acceleration program (MYSIAP) under Ministry of Science Innovation and Technology (MOSTI).

References

- J. Timbuong, "Firefighters dealt with more fires in first MCO | The Star." <https://www.thestar.com.my/news/nation/2020/12/12/firefighters-deal-with-more-fires-in-first-mco> (accessed May 10, 2021).
- S. J. Chen, D. C. Hovde, K. A. Peterson, and A. W. Marshall, (2007) "Fire detection using smoke and gas sensors," *Fire Saf. J.*, vol. 42, no. 8, pp. 507–515, Nov. 2007, doi: 10.1016/j.firesaf.2007.01.006.
- J. Yang, M. Liu, J. Lu, Y. Miao, M. A. Hossain, and M. F. Alhamid, (2018) "Botanical Internet of Things: Toward Smart Indoor Farming by Connecting People, Plant, Data and Clouds," *Mob. Networks Appl.*, vol. 23, no. 2, pp. 188–202, 2018, doi: 10.1007/s11036-017-0930-x.
- S. R. Prathibha, A. Hongal, and M. P. Jyothi, (2017) "IoT Based Monitoring System in Smart Agriculture," *Proc. - 2017 Int. Conf. Recent Adv. Electron. Commun. Technol. ICRAECT 2017*, pp. 81–84, 2017, doi: 10.1109/ICRAECT.2017.52.
- M. A. Zamora-Izquierdo, J. Santa, J. A. Martínez, V. Martínez, and A. F. Skarmeta, (2019) "Smart farming IoT platform based on edge and cloud computing," *Biosyst. Eng.*, vol. 177, pp. 4–17, 2019, doi: 10.1016/j.biosystemseng.2018.10.014.
- V. Pravalika and C. Rajendra Prasad, (2019). "Internet of things based home monitoring and device control using Esp32," *Int. J. Recent Technol. Eng.*, vol. 8, no. 1 Special Issue 4, pp. 58–62, 2019.
- V. Thirupathi and K. Sagar, (2018) "Implementation of home automation system using mqtt protocol and esp32," *Int. J. Eng. Adv. Technol.*, vol. 8, no. 2C2, pp. 111–113, 2018.

SIMPLE COIN BANK USING ESP32

Noraida binti Yusoff

Politeknik Kota Bharu, Ketereh, Malaysia
yusoffnoraida18@gmail.com

Hirni binti Rashid, Ajmal Danish bin Mohd Zemri, Muhamad Akmal Aiman bin Mohd Azlan

Politeknik Kota Bharu, Ketereh, Malaysia
hirni760512@gmail.com, ajmal.danish77@gmail.com, akmalaimanazlan@gmail.com

Highlights: Saving is an act in which we save money little by little for our future use during times of emergency such as running out of savings. This electronic project can facilitate users in terms of automatically calculating the amount of each coin we put in the tube. This electronic project system consists of infra red sensor, 16X2 Led 12C Display, ESP32 Microcontroller, Buzzer and Push Button Switch. Then the circuit is used to view the output from the programmed 16X2 Led 12C display. The use of this system can facilitate users because it displays the amount of Malaysian coins according to the type of coin which is 10 sen, 20 sen and 50 sen. This project is very necessary because it can further encourage the practice of saving money among children, even adults to continue saving for the sake of the future.

Key words: *saving; infrared sensor; ESP32 Microcontroller; 16X2 Led 12C Display; coins.*

Introduction

The saving practice has become a role model and example to everyone no matter old or young. This practice has had a positive impact on society both financially and emotionally. Although this saving practice has long been practiced in Malaysia, but the problem of counting coins will cause a waste of time and space because there is no automatic coin counting machine. To create this tool, it needs to be studied and to create it requires knowledge and skills in the field of electronics. Therefore, the production of a tube that can count money automatically can help savers in separating coins based on the value of 10 sen, 20 sen and 50 sen and can calculate the total of all coins that have been collected to date. The resulting tube can function to store, count and segregate the coins as well as meet the characteristics desired by savers. Apart from that, the creation of this tube can ease the burden and save time for savers.

Objectives

The objectives of doing this project is to solve the problem and ease the users in calculating their saving in the tube without broken it. This tube is able to save time for savers to calculate the amount of coins that have been collected over the years. This tube will provide very accurate calculations without errors because this tube is equipped with a 'scan sensor' system. This tube can also facilitate savers in the process of counting coins by directly displaying the amount of coins available in the tube.

Scope of Research

The scope of the research of this project is focused on all age groups in one family living in a housing estate. The scope of the study is more focused on residents in housing estates as most of them have been practicing this saving practice since time immemorial as a good and frugal practice in managing family finances. Residents in these housing estates usually have to go to a nearby bank to get the service of counting the amount of coins in their savings coffers. There are also elderly people who still practice this saving practice, their memory is certainly limited and it is difficult to calculate savings accurately.

Methodology

Simple Coin Bank Using ESP32 is a project in the form of a real product that can continue to be used by all sections of society. The tube is able to address the problems faced by the community of all ages in the calculation of savings coins. In addition, the creation of this tube will save more time and energy. In addition, the tube also has various functions that can help solve the problem of savers.

The project was implemented using the ESP32 Microcontroller, the Arduino programming language and an Android-based mobile application. The ESP32 microcontroller is used to integrate all electronic devices in one environment. ESP32 is used because it has two cores, one core to run WiFi functions and one core to execute uploaded programs. The ESP32 also has WiFi and Bluetooth modules and 36 GPIOs.

Experimental Results

The prototype for this project has been done successfully. For part of the experiment, the prototype was tested to prove the relationship between the infra red sensor and the display. The Infra red sensor will send a signal to the ESP32 and will display the amount of coins entering the tube.

Table 1: Relationship experiments

Component	Signal
Infra Red Sensor	Successfully delivered
Display	Successfully delivered



Figure 1 : Simple Coin Bank Using ESP32

Description of Product Development

Simple Coin Bank using ESP32 originally a regular tube but has been innovated into an electronic system project. This tube is able to calculate the amount of coins that have been saved. There are various advantages to this tube that are able to facilitate the user. In addition, the tube is equipped with the ESP32 Microcontroller program system and consists of 16x2 LED12C, Buzzer, infrared sensor and push button switch. This tube is very necessary because it can encourage the practice of saving money among children, even adults to continue saving for the future.

Background of Product Development

Simple Coin Bank using ESP32 is used to keep saving Malaysian coins resulting from 10 sen, 20 sen and 50 sen from our income money. Nowadays, the variety of tubes in terms of color, design and concept were sold in market. There are factors and effects that cause a waste of time in the calculation of coins and use a space to remove all the coins that have been collected. Therefore, after the innovation, the tube called Simple Coin Bank Using ESP 32 is able to overcome the problem of wasting time in calculating coins because this tube can trace and display the amount of coins and each type of coin in the tube. Finally, this project is able to facilitate consumers and encourage the practice of saving money among children and even adults to continue saving for the future.

The Importance of Project Towards Education and Community

It is very important to education because it can cultivate the practice of saving to consumers and also at the same time can discipline consumers in being frugal in their spending. Nowadays, our country is hit by the Covid -19 pandemic, every individual should have a saving attitude because during this time, many individuals have lost their jobs. Therefore, saving attitude can help community to lead a better life.

The Advantages of Product

The advantages of this product are able to count savings coins especially Malaysian coins including 10 sen, 20 sen and 50 sen. It also can store coins well because it is equipped with a security system. This tube is also environmentally friendly and able to separate coins according to the value of the coin itself.

The Commercial Value in Terms of Marketability or Profitability Product

The product is different from the tubes that were sold in the market. Among the differences is that it has a sensor that can detect the value of Malaysian coins. This product was equipped with a program that can calculate the amount of coins that have been saved by users. In addition, it has a large money storage space to allow users to save more coins.

References

- Dkardu. (2020, August 21) *How to make smart coin counting bank with arduino smart money box.*
<https://www.hackster.io/DKARDU/how-to-make-coin-counting-bank-with-arduino-smart-money-box-f05ffa>
 Edutech. (2020, March 5). *Esp32 pinout, circuit. - Free Esp32 Datasheet Download.*
<https://www.alldatasheet.com/esp32>

IoT-BASED DOOR ACCESS CONTROL USING FACE RECOGNITION

Muhammad Afiq Bin Aznan

Faculty of Electronic Engineering Technology, Universiti Malaysia Perlis, Arau, Malaysia
s171231725@studentmail.unimap.edu.my

Ts. Dr. Siti Zuraidah Ibrahim, Ts. Dr. Ku Nurul Fazira Ku Azir, Assoc. Prof. Dr. Ruzelita Ngadiran

Faculty of Electronic Engineering Technology, Universiti Malaysia Perlis, Arau, Malaysia
sifizuraidah@unimap.edu.my, fazira@unimap.edu.my, ruzelita@unimap.edu.my

Highlights: This innovation project proposes an IoT Door System with CCTV monitoring to control door access by authorized users using facial recognition technique and the Telegram application along with a database to record user logs. In this system, the user's face will be captured and processed to match to the registered face, and then the system will use Telegram Bot to send a message to the user. If the password is valid, the system will send a signal to the hardware to unlock the door. The results showed that the developed prototype of this system successfully operated as expected.

Key words: *Face recognition, Smart Door, Security, IoT.*

Introduction

In the 4.0 revolution industry, technology has evolved rapidly. With the introduction of IoT, people can improve security and safety methods to protect access to offices and building facilities whether using access cards, fingerprint detection or keypad passwords. In epidemic situations such as the novel coronavirus pandemic (COVID-19), many organizations using traditional methods are forced to switch to face-based systems to avoid direct contact with surfaces shared by multiple people working in the same organization. The contactless surface approach is considered an important prevention in daily life against coronavirus. Driven by this situation, we propose a contactless IoT system that implements secure access to building premises using facial recognition technology along with password authentication. This is more demanded during Covid-19 outbreaks where the risk of infection should be minimized to control the spread of the virus.

Content

In this innovation project, we demonstrated secure contactless building door access using face recognition software and the Telegram app. The development of these innovations requires the involvement of software and hardware divisions.

In terms of hardware development, it will involve several components as shown in Figure 1 (a). A 12V power supply will power the Solenoid door lock, but must go through the relay module first. The relay module will allow current to flow based on the signal sent by the NodeMCU. The nodeMCU will control the relay module by sending a high or low digital signal from pin D3 and providing 3V power to the relay.

The entire operation of the software is handled by our own-developed software written in the python platform as shown in Figure 1 (b) that controls the interaction between face recognition, telegram bot, database query, and door unlock. To maximize door access security, we recommend THREE (3) layers of door access security. In the first layer, face recognition is done to detect the user who wants to access the door by showing his face on a camera mounted on the door. If the captured face is correctly identified with a picture stored in the database system, it will send the data to a telegram bot to address the second and third layers of security. In the second layer of security, Telegram Bot was set up to listen to or reply to only Telegram Chat IDs registered in the database system. Telegram Bot will not send any messages unless the system recognizes the face correctly. At this stage, users only use their own smartphones to access the Telegram app. Finally, in third layer security (authentication), the telegram bot will continue to communicate with the user by asking the user to enter the password in a short time. Telegram Bot will automatically reply that the password entered is either True or False.

When the user is successfully authenticates, the automated bot will unlock the door for 10 seconds and save the captured picture to make sure that the person is entering the door. The Telegram Bot will automatically delete the password entered after 2 seconds to protect user passwords from leaking. The door will automatically be locked after a 10-second pass, and the user has a one-time pass key to unlock the door from the inside. The camera is operating 24-hour as the security management to view the live feed and to record video. All this process from face detection to saving picture while entering the door will be recorded in the database and administrator of this software can view this record anytime.

LCD on the hardware will display the current state of the system. It will start with the first message by showing "Face detection is ready". If the face is correctly recognized, LCD display will show the name of the recognized person, otherwise it will show "unrecognized face" for 5 seconds, then return to "Face detection is ready". If the password is authentic and the door is unlocked, the LCD display will show "Door Successfully Unlocked".

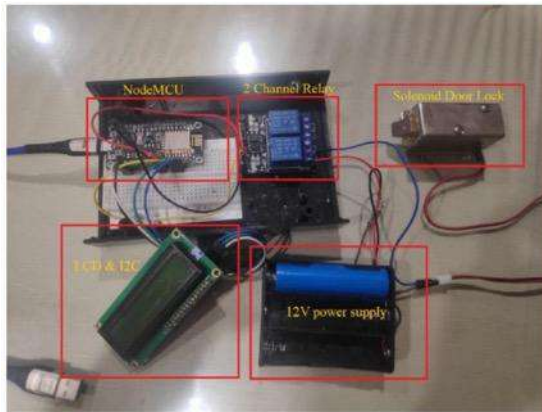

(a) Hardware prototype



(b) Software Graphical User Interface (GUI)

Figure 1: The hardware and software of IoT-Based Door Access Control Using Face Recognition

Since the COVID-19 coronavirus spread through contact, the previously used unlocking system based on fingerprint or password is also not safe. Therefore, multiple authentication application that depends on facial recognition are become crucial. Similarly, various companies focus on developing innovative smart door products to mitigate the impact of Covid19 crisis on the security application. This is expected to drive the growth of the facial ID smart door market post-pandemic in the long term.

Reference

Baluprithviraj, K. N., Bharathi, K. R., Chendhuran, S., & Lokeshwaran, P. (2021, March). Artificial Intelligence based Smart Door with Face Mask Detection. In 2021 International Conference on Artificial Intelligence and Smart Systems (ICAIS) (pp. 543-548). IEEE.

LOW-COST AUTOMATIC CAT FEEDER

Nawi bin Berahim

Politeknik Kota Bharu,
Km 24, Kok Lanas, 16450 Ketereh, Kelantan, Malaysia
nawi5333@gmail.com

Ahmad Irfan bin Kamaruddin, Muhammad Afiq bin Na Amran

Politeknik Kota Bharu,
Km 24, Kok Lanas, 16450 Ketereh, Kelantan, Malaysia
irfankamaruddin45@gmail.com, afiqsmkpc2@gmail.com

Highlights: Low-cost Automatic Cat Feeder is a project explains about the designing and developing an automatic cat feeder to ease the burden of the cat owner or cat lover. The purpose and concept of this project is to feed the cat automatically without the present of the owner. This project was developed using Arduino microcontroller as the main controller of the system. The microcontroller used in this project is programmed using the Arduino Software. The other main components used are servo motor for rotating control and an ultrasonic sensor as stimulus to detect the presence of cats at a close distance in order to open the food container. When the cats come closed to the ultrasonic sensor, the servo motor will rotate to open the container cover that contains the food for cats. It is hoped that this project will provide benefit and convenience to the users or cat lovers.

Key words: *Cat Feeder, Arduino Microcontroller, Servo motor, Ultrasonic Sensor*

Introduction

Most of us have cats at our home. Some of us or cat lovers could not afford to buy an expensive cat feeder. Therefore, this automatic cat feeder was fabricated at a low-cost price. So, this will bring many benefits to cat lovers who cannot afford the expensive one. In addition, by using this product it will make easier to users to feed their cat automatically.

The project entitled Low-Cost Automatic Cat Feeder is designed and fabricated to facilitate cat owner to feed their cat automatically especially when they are not at home. This cat feeder uses an Arduino microcontroller and it is equipped with two main components namely an ultrasonic sensor and a servo motor. When the cat approaches to the ultrasonic sensor, the servo motor will rotate in order to open the cover of food container. Overall, this device can be utilized for the convenience of the users or cat lovers.

Product Development

The main materials used in the development of Automatic Cat Feeder are Arduino microcontroller, servo motor and ultrasonic sensor. Plastic box is used for food container. All materials used are good at economic cost. Arduino microcontroller, servo motor and ultrasonic sensor are attached to the plastic box container. The Liquid Crystal Display (LCD) is also attached to the box just to display the cat is around or not. The cost to produce this product is less than RM100.00. The project is well functioning and meet the objective. Figure 1 below shows the main materials used and prototype of the product.



Figure 1 (a) Arduino Uno



Figure 1 (b) Ultrasonic Sensor



Figure 1 (c) Prototype of Low-Cost Automatic Cat Feeder

Significance of Product

An automatic cat feeder is provided for feeding cats of food while the owner is absent or otherwise engaged. The programming of the sensor determines when the feeder cover is to be opened so that the cat may

have access to the food provided in it. Automatic Cat Feeder is a portable device, light weight that easy to bring and move to everywhere. This project is concern on well proven safety aspect in the project design.

Advantages of Product Development

Nowadays, everyone can have cats at home. Automated cat feeder is built to help cats owner taking care of their cats. This is an innovation that should help user or cats' owner take care of cats better. Automated cat feeder is one of innovation for feed cat automatically. It will help cats' owner to take care of their cat while they are not at home. With this automatic feeding product, it will help cat owner to feed their cat automatically. The automated cat feeder will be automatically open the food container when cat approaches the sensor of cat feeder.

Marketability of Product

The cost of producing Automatic Cat Feeder is quite cheaper. This cat feeder has commercial potential due to the availability of cat lover or those who have cats at their home. The usage of Automatic Cat Feeder is also safe to the environment as it uses materials that are free of chemicals. Automatic Cat Feeder is easy to use, light weight and can be shifted or moved to any places.

In the future, the researchers hope to promote Automatic Cat Feeder using social media such Marketplace, Facebook and WhatsApp. The features of the product and finishing will be improved from time to time.

Acknowledgement

We are grateful to Mr Nik Nor Hishamuddin bin Nik Mustapha (as the Project Coordinator) for their guidance and support which enable us to complete this project successfully. We also would like to express gratitude and deep appreciation to the Jabatan Kejuruteraan Elektrik, Politeknik Kota Bharu for providing facilities and equipment.

References

- Kank, Aasavari and Gaikwad (Mohite), Vaishali. (October 20, 2018). Automatic Pet Feeder. Available at SSRN: <https://ssrn.com/abstract=3274472> or <http://dx.doi.org/10.2139/ssrn.3274472>
- Simon Monks. (2010). *30 Arduino Projects for The Evil Genius*. New York: Mc Graw Hill
- Tiwari M.S., Hawal S.M., Mhatre N.N, Bhosale A.R., Bhaumik M. (2018). *Automatic Pet Feeder Using Arduino. International Journal of Innovative Research in Science, Engineering and Technology*, 7(3), 2891-2897

REGENERATIVE BRAKING SYSTEM FOR ELECTRIC VEHICLES

Mohammad Muktafi Ali Khan

Department of Electrical Engineering, Zakir Hussain Engineering College, Aligarh Muslim University, 202002 Aligarh, Uttar Pradesh, India
mmuktafialikhan@gmail.com

Mohammad Muqtada Ali Khan¹, Hafzan Eva Manosr¹, Elvaene James¹, Zaitul Zahira Binti Ghali @ Ghazali¹, Sarizam bin Mamat²

¹Department of Geoscience, Faculty of Earth Science, Universiti Malaysia Kelantan, Campus Jeli, Locked Beg No 100, 17600 Jeli, Kelantan, Malaysia

²Faculty of Bioengineering and Technology, Universiti Malaysia Kelantan, Campus Jeli, Locked Beg No 100, 17600 Jeli, Kelantan, Malaysia
muqtada@umk.edu.my, hafzan.eva@umk.edu.my, elvaene@umk.edu.my, zaitulzahira@umk.edu.my, sarizam@umk.edu.my

Highlights: In the present invention, A regenerative braking system for Electric Vehicles (RBS EV) is a mechanism that reduces vehicle speed by converting its kinetic energy into a storable form of energy instead of dissipating it as heat as with a conventional brake. The captured energy is stored for future use or fed back into a battery of the EV. In battery operated EV and hybrid electric vehicles the energy is stored in a battery or bank of capacitors for later use. Regenerative braking systems reclaim and storing the kinetic energy of EV in a reusable manner. Conventional braking systems convert kinetic energy into heat, usually via friction. This wastes a great deal of energy which RBS reclaim and storing this wastes of energy (kinetic energy) of EV in a reusable manner.

Key words: *Regenerative braking System, Electric Vehicles, battery, Kinetic Energy*

Introduction

If you drive in an urban & rural area, you probably realize you're continually stopping and starting on the road. It's a big waste of time, but you might not also realize that it's a huge waste of energy. Making a vehicle move forward requires needs a large input of power, and every time you step on the brakes, all the energy you built up dissipates. According to the rules of physics, energy cannot be destroyed. That means when your vehicle slows down, the kinetic energy that was moving it forward has to go somewhere -- it's lost in the brake pads and released as heat. But what if you could store up this energy and use it when you next begin to accelerate it. That's the basic principle behind Regenerative Braking System, which are widely used in electric cars and trains.

Now a Days, Many modern electric drive vehicles including electric locomotives and HEVs have regenerative braking systems. Examples include the HEV such as Toyota Prius, Honda Insight. Early examples of this system were the front-wheel drive conversions of horse-drawn cabs by Louis Antoine Krieger (1868-1951). The Krieger electric landaulet had a drive motor in each front wheel with a second set of parallel windings (bifilar coil) for regenerative braking.

Description of your innovation

Regenerative braking is a system in which the electric motor that normally drives a hybrid or pure electric vehicle is essentially operated in reverse (electrically) during braking or coasting. Instead of consuming energy to propel a vehicle, the motor acts as a generator that charges the onboard batteries with electrical energy that would normally be lost as heat through traditional mechanical friction brakes. As the motor "acts in reverse," it generates electricity. The accompanying friction (electrical resistance) assists the normal brake pads in overcoming inertia and helps slow the vehicle.

Vehicles driven by electric motors use the motor as a generator when using regenerative braking: it is operated as a generator during braking and its output is supplied to an electrical load; the transfer of energy to the load provides the braking effect.

Electric motors, when used in reverse function as generators, convert mechanical energy into electrical energy. Vehicles propelled by electric motors use them as generators when using regenerative braking, braking by transferring mechanical energy from the wheels to an electrical load. In Motor Mode of EV works, when Vehicle has forward or reverse momentum. The wheels of EV are coupled to the rotor of EV Motor in an EV. When of a current being applied to the motor of the EV to turn the rotors, the rotors are rotate the wheels of the EV.

But in RBS of EV, Instead of a current being applied to the motor to turn the rotors, the rotors are turned by the wheels of the EV. The rotors experience opposing torque as current is induced in the motor coils. This opposing torque slows the speed of EV and generated electrical energy is stored.

In Acceleration mode and cruising mode, RBS of EV use their drive motors to convert Electrical energy into Mechanical energy (Rotating Motion). But in Slowing down mode and braking mode, RBS of EV use their drive motors to convert Kinetic energy of the Wheels into Electromagnetic Energy (Electrical Energy) which shows in Fig 1. Motors and generators operate under the same principle and can be used interchangeably. The First Law of

Thermodynamics dictates that dissipated through a resistive net

Coordinates motor and friction parameters into account and de medium state-of-charge, Route controller of RBS in EV must be voltage for safe charging (depe

In RBS of Road Vehicle efficiency in stop and go city tr Shape, Mass, momentum and Storage option And State of cha

Practical Regenerative standstill, or slowing it as require

The regenerative braking effect drops off at lower speeds, and cannot bring a vehicle to a complete halt reasonably quickly. A regenerative brake does not immobilize a stationary vehicle; physical locking is required, for example to prevent vehicles from rolling down hills.

Many road vehicles with regenerative braking do not have driven motors on all wheels (as in a two-wheel drive car); regenerative braking is normally only applicable to wheels with motors. For safety, the ability to brake all wheels is required. The regenerative braking effect available is limited, and insufficient in many cases, particularly in emergency situations. Therefore the friction brake is a necessary back-up in the event of failure of the regenerative brake.

Background of the innovation

A regenerative brake is an energy recovery mechanism which slows a vehicle or object by converting its kinetic energy into a form which can be either used immediately or stored until needed. This contrasts with conventional braking systems, where the excess kinetic energy is converted to unwanted and wasted heat by friction in the brakes, or with dynamic brakes, where energy is recovered by using electric motors as generators but is immediately dissipated as heat in resistors. In addition to improving the overall efficiency of the vehicle, regenerative braking system (RBS) can greatly extend the life of the braking system as its parts do not wear as quickly (Table 1).

Important to education

Now a days, every students have vehicles, and every vehicles has braking system for reduce the speed of Vehicle and stop it, during the braking all kinetic energy of the vehicle is lost. So it is very beneficial to know. How do you store the kinetic energy of the vehicle for increasing efficiency? Regenerative Braking system is a topic of Electrical and Mechanical Engineering.

Advantages of your innovation towards community

- (i) Increases efficiency & performance, (ii) Saving up to 35% in energy consumption, (iii) Increases the lifespan of Battery, (iv) Cut down Electricity Bill, (v) Increases the lifespan of Brake Shoe.

Table 1: Increases efficiency in Percentage in Electric Vehicle with the use of Regenerative braking System in different number of braking per KM

Number of Braking / KM	Total Number of Braking in 100 KM	Average Regenerative Braking Charging Current (In Amp)	Average Duration of Braking(In Seconds)	Total RBS Charging current in 100 km = (Number of total Braking X18 X 7.5)/3600 in AH	Efficiency increases in terms of Percentage
1	100	18	7.5	3.75 AH	3.75 %
2	200	18	7.5	7.50 AH	7.50 %
3	300	18	7.5	11.25 AH	11.25 %
4	400	18	7.5	15.0 AH	15.0 %
5	500	18	7.5	18.75 AH	18.75 %
6	600	18	7.5	22.50 AH	22.5 %
7	700	18	7.5	26.25 AH	26.25 %
8	800	18	7.5	30.0 AH	30.0 %

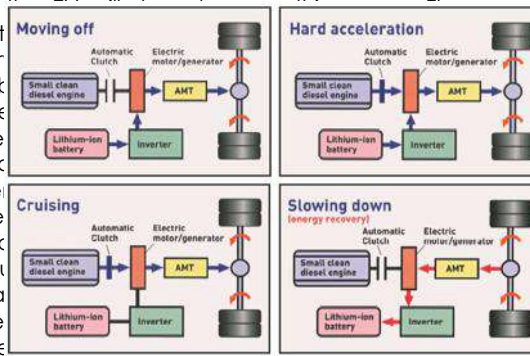

ted electrical energy can be ing).

at handle braking functions. ontroller will take the following e, Driver input (pedals), Storage the desired output. The brake e proper polarity, current, and

raking. RBS of EV improves the ary greatly from vehicle speed, vary from EV to EV, RBS, and

f safely bringing a vehicle to a raking system such as friction-

based braking. The regenerative braking effect drops off at lower speeds, and cannot bring a vehicle to a complete halt reasonably quickly. A regenerative brake does not immobilize a stationary vehicle; physical locking is required, for example to prevent vehicles from rolling down hills.

Many road vehicles with regenerative braking do not have driven motors on all wheels (as in a two-wheel drive car); regenerative braking is normally only applicable to wheels with motors. For safety, the ability to brake all wheels is required. The regenerative braking effect available is limited, and insufficient in many cases, particularly in emergency situations. Therefore the friction brake is a necessary back-up in the event of failure of the regenerative brake.

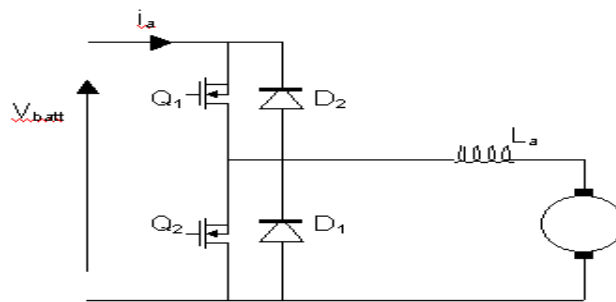
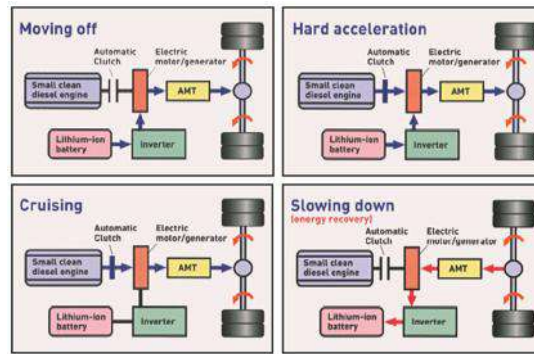

In Figure 2 when t_1 _____, the current can flow backwards (because the motor is generating) through Q_2 which is turned on. When Q_2 turns off, this current is maintained by the inductance, and current will flow up through D_2 and back into the battery.

Acknowledgement

We are grateful for Prof Dr Syed Jamil Asghar and his team for continuous and valuable advices throughout this project and also acknowledged Department of Electrical engineering, Aligarh Muslim University for providing basic facilities.

References

- Varocky B. J. (2011) "Benchmarking of regenerative braking for a fully electric car", TNO Automotive Helmond & Technische Universiteit Eindhoven.
Show in Context Google Scholar
- Boerboom. M (2012) *Electric Vehicle Blended Braking maximizing energy recovery while maintaining vehicle stability and maneuverability.*
Show in Context Google Scholar
- De Mers. S.M. (2008), "Mechanical and Regenerative Braking Integration for aHybrid Electric Vehicle", *Canada Master of Applied Science in Mechanical Engineering.*
Show in Context Google Scholar
- Hinov, N.L., Penev, D.N., Vacheva, G.L. (2016), "Ultra capacitors charging by regenerative braking in electric vehicles", 2016 XXV *International Scientific Conference Electronics (ET)*, pp. 1-4.
- Cody J., Göl Özdemir, Nedic,Z., Nafalski, A., Mohtar, A., Hamowania, O. (2009). *Regenerative braking in an electric vehicle.*

HEALTH EDUCATION MODULE (HEM) FOR THE PREVENTION OF RESPIRATORY ILLNESSES DURING HAJJ AND UMRAH

Mohammed Dauda Goni

Universiti Malaysia Kelantan, Kota Bharu, Malaysia
dauda.g@umk.edu.my

Aisha Abubakar Baaba, Ibrahim Abdul Azeez Okene

Universiti Malaysia Kelantan, Kota Bharu, Malaysia
mandybaaba@gmail.com, Ibrahim.az@umk.edu.my

Highlights: We developed a smartphone application to improve the knowledge, attitude, and practice of Malaysia Hajj and Umrah pilgrims for the prevention of respiratory tract infections. This smartphone application was developed based on the Health Belief Model (HBM). The HBM predict health-related behaviours, particularly regarding the uptake of health services. We focused on World Health Organization preventive guidelines for prevention respiratory infections during mass gathering. The health education intervention application (Hajj HEM) consists of pages for registration and pages for demonstrating the overview of respiratory tract infection and prevention steps for contracting the infections.

Key words: hajj, health education, smart-phone application, respiratory tract infection key

Introduction

Hajj Annually, the Hajj pilgrimage to Makkah in Saudi Arabia attracts an estimated 10 million Muslim faithful from across the world. This pilgrimage is usually associated with a regular occurrence of respiratory illnesses among pilgrims. Hajj can equally pose a risk for many respiratory tract infections (RTIs) as well as the outbreaks communicable diseases. Over 90% of pilgrims suffered from at least a specified respiratory symptom and the risk of respiratory infections due to mainly viruses increases several folds during Hajj. The transmission and dissemination of respiratory viruses during the Hajj period could result in the worldwide spread, which has already been reported among the US pilgrims. High occurrence of respiratory illnesses was reported among returning Malaysian Hajj pilgrims even though they practice some preventive measures.

The Smartphone and cyber-based technologies have been regarded as a suitable and feasible means to deliver intervention modules in several studies. Smartphone phone-based application delivery has been used broadly and successfully to sustain portable and widespread interventions. The capacity to digitally distribute material grants multiple benefits to health care researchers and end-users alike; prominently, personalization of resources, enhanced scalability, and affordable costs. Hence it is hypothesized that a health educational module that proffers evidence-based data concerning risk factors associated with respiratory infections prevention strategies may have the added advantage of decreasing the uncertainty for other health situations with a distinct improvement in general well-being.

Some studies have been conducted on educational interventions on respiratory tract infection prevention among Hajj pilgrims from different countries. However, none of the health educational intervention was based on any health behaviour theory to boost compliance with these preventive practices and increase their levels of knowledge towards respiratory tract infection, preventive attitudes, and practices towards prevention strategies. Similarly, there is also low compliance with the preventive measures among Malaysian pilgrims. Therefore, this project is aimed at developing and evaluating the impact of health education intervention in reducing the incidence of respiratory illnesses among Hajj pilgrims from Malaysia.

Content

The development and validation were conducted through different steps. The first step in the development process comprised an extensive review that identified the items relevant to the health educational module. The recommendation for the prevention of RTI based on the recommendation of WHO and CDC were identified. A panel of experts evaluated the completed health education module for appropriateness and relevance of content. For the content validation and pre-testing of the module, a qualitative analysis was conducted to explore the opinions, ideas, perceptions, and concerns of the pilgrims regarding the content, layout, and design of the module. The qualitative study questions were scripted accordingly. At the end of the session, participants were asked, "Is there anything else you would like to share with us," to allow them to provide information inadvertently omitted during the FGDs. This FGD interview protocol was reviewed by expert panels comprising a public health scientist, a microbiologist, an epidemiologist, and a computer scientist. The health education intervention application (Hajj HEM) has several major components, including (1) pages for registering the users and (2) pages demonstrating the overview of respiratory tract infection and prevention steps for contracting the infections. To overcome the challenges of lost in internet connection, the application was designed to function even without an internet connection once it is installed in the smartphone. The final version of the Hajj HEM application can be assessed through this URL <https://play.google.com/store/apps/details?id=my.usm.hc.sms.hajjhem> and screenshot of the splash screen is shown in Figure 3.3. The application was restricted to only pilgrims that consented to participate in the study. Copyright and patent of the application are in process.

Participants were encouraged to be compliant regarding the usage of the smartphone application before, during and after Hajj. The formative assessment section was included in the module for the evaluations of participants comprehension, learning needs and progress throughout the intervention. The positive impact of a smartphone-based health intervention on the incidence of respiratory illnesses. This module will also be important particularly with the present COVID-19 pandemic in which the module addressed the prevention practices that are applicable COVID-19 prevention guidelines.



Screenshot of the home screen of the Hajj HEM application

References

- Barasheed O, Rashid H, Alfelali M, Tashani M, Azeem M, Bokhary H, et al. Viral respiratory infections among Hajj pilgrims in 2013. *Virologica Sinica*. 2014;29(6):364-71.
- Benkouiten S, Charrel R, Belhouchat K, Drali T, Nougairede A, Salez N, et al. Respiratory viruses and bacteria among pilgrims during the 2013 Hajj. *Emerging infectious diseases*. 2014;20(11):1821.
- ECDC. Public health risks related to communicable diseases during the Hajj 2017, Saudi Arabia 30 August – 4 September 2017: European Centre for Disease Prevention and Control; 2017 [Available from: <https://ecdc.europa.eu/sites/portal/files/documents/RRA-Mass-gathering-Saudi-Arabia-Hajj-10-Aug-2017.pdf>].
- Farrag MA, Hamed ME, Amer HM, Almajhdi FN. Epidemiology of respiratory viruses in Saudi Arabia: toward a complete picture. *Archives of virology*. 2019:1-16.
- Hashim S, Ayub ZN, Mohamed Z, Hasan H, Harun A, Ismail N, et al. The prevalence and preventive measures of the respiratory illness among Malaysian pilgrims in 2013 Hajj season. *J Travel Med*. 2016;23(2):tav019.
- Hoang VT, Gautret P. Infectious Diseases and Mass Gatherings. *Current infectious disease reports*. 2018;20(11):44.
- Madani TA, Ghabrah TM, Al-Hedaithy MA, Alhazmi MA, Alazraqi TA, Albarrak AM, et al. Causes of hospitalization of pilgrims during the Hajj period of the Islamic year 1423 (2003). *Annals of Saudi medicine*. 2006;26(5):346-51.
- Parker S, Hoosen AA, Feldman C, Gamil A, Naidoo J, Khan S. Respiratory infections due to *Streptococcus pneumoniae* and the influenza virus in South Africans undertaking the Hajj. *Southern African Journal of Infectious Diseases*. 2018:1-5., A. J., O'Connor, M. J., & Van Dyke, J. (1994). *People Smarts: Bending the Golden Rule to Give Others what They Want*. Pfeiffer.

TOWARDS AQUACULTURE PRECISION FARMING: IoT BIG DATA ANALYTICS USING MACHINE LEARNING

Khalifa Chekima

Borneo International Tradings Sdn Bhd
K.chekima@gmail.com

Brahim Chekima

Faculty of Business, Economics and Accountancy
b.chekima@gmail.com

Highlights: The COVID-19 pandemic, has presented itself as a wicked problem where both the disease and its containment measures have caused significant human suffering. The pandemic has also affected every aspect of the economy including aquaculture. The Covid-19 and its containment measures, such as restrictions on the mobility of people, social distancing and ban on public gathering, have disrupted fish production, due to the fact that aquaculture process is a human labor intensive. This phenomena directly affected the food safety. An early initiatives to address this issues was proposed using an IoT based system (Martin et al, 2017) which also known as smart farming, mainly to automate the process related to aquaculture such as fish feeding, water monitoring including PH level and water turbidity. As a result of using IoT, huge amount of data were produced by these sensors, however, in Malaysia most of existing IoT aquaculture systems were built for the purpose of automation, in other words, the data produced by these sensors were not fully utilized to improve the aquaculture production by extracting the insights for future panning and prediction. Despite having such a useful data, aquaculture farmers still rely on human expert's advice. In this paper, we developed a precision farming prototype and proposed a model using machine learning (Bayesian Model) where all the parameters are set by data rather than expert's experience. Based on the outcome, the proposed prototype were able to fully automate the aquaculture process while producing insights from data to assist farmers in their decision making and future prediction.

Key words: *Smart Farming, Precision Farming, Artificial Intelligence, Machine Learning, IoT, Big Data Analytics*

Introduction

Proposed IoT Prototype

Fish farming refers to the keeping and breeding of fish commercially carried out in controlled areas, usually to secure food supply, breed ornamental fish or as a recreation such as fishing (O'Donncha & Grant, 2019). Among the type of fish ponds being used including ground pond, concrete tank, Polyethylene tank, canvas and fiber glass tank. Many challenges faced by the traditional system including maintaining the water quality such as Ph level, water level, ammonia level, wand water temperature, biological factors including presences of bacteria, presence of toxic microalga, etc. Lack of labor workers, or due to natural factors such as weather (Yang et al, 2021).

The Industrial Revolution 4.0 opened up opportunities for the improvement of water quality monitoring and control activities in aquaculture farms (Bongiovanni &Lowenberg, 2004). The Internet of things (IoT) is one of the key technologies introduced for this monitoring and control purpose. In this work. We present the use of IoT to address most of the challenges face by aquaculture farmers, at the same time we make use of data produced by sensors by extracting insights that benefits users in decision making as well as in future prediction. Diagrams below under figure 1 and 2 describes the flow of sensors involved.

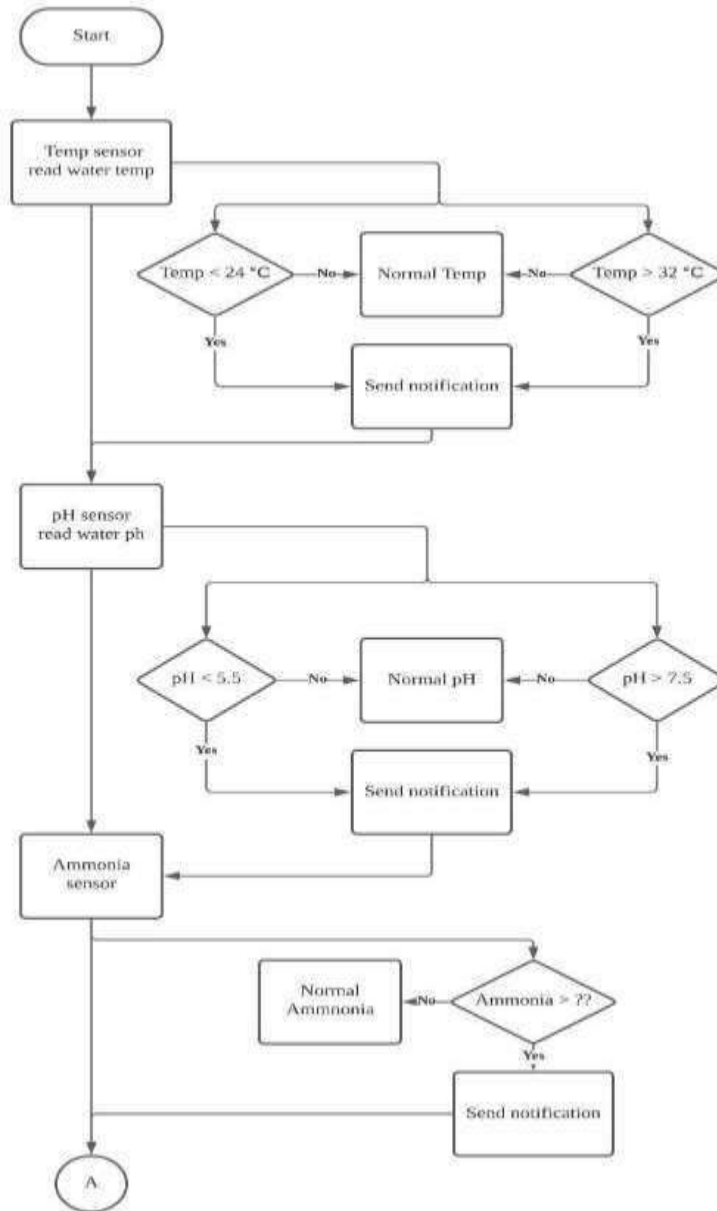
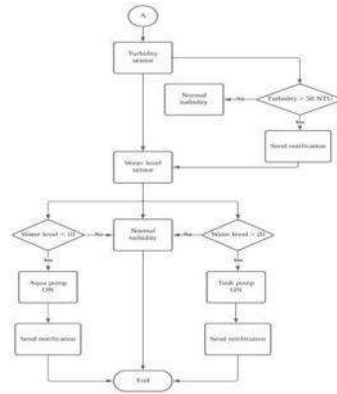

Figure 1 & 2: Sensors Flow



Basically, in the proposed prototype, there are 6 different type of sensors including water temperature sensor, ph level sensor, ammonia sensor, water level sensor, feeding sensor, and turbidity sensor. As a result a rich data is produce by these sensors throughout the day, figure 3. Sensors can be adjust to produce data according to its nature of task. Data can be extracted from sensors as frequent as needed by user, example every second, every minutes, hourly, daily, weekly, monthly, etc. Once data is produced, we adopt machine learning technique (Naive Bayes Classification) to keep track of any changes that occurs in the pond. Whenever a new sensor readings arrives, it will be compare with initial readings and if any drastic change in readings, system will automatically notifies the user, at the same time it will take the necessary action to solve any issue. This save time as well as effort.

Time	Datastream Name	Value
1.63E+09	TEMPERATURE	26.991143
1.63E+09	AMMONIA	208.95238
1.63E+09	WATER LEVEL	14.420857
1.63E+09	Turbidity	3000
1.63E+09	Ph	7.8439048
1.63E+09	TEMPERATURE	26.93181
1.63E+09	AMMONIA	154.38095
1.63E+09	WATER LEVEL	15.174524
1.63E+09	Turbidity	3000
1.63E+09	Ph	8.2990952
1.63E+09	TEMPERATURE	26.93795
1.63E+09	AMMONIA	132.7
1.63E+09	WATER LEVEL	14.45
1.63E+09	Turbidity	3000
1.63E+09	Ph	8.29855
1.63E+09	TEMPERATURE	26.940905
1.63E+09	AMMONIA	363.2381
1.63E+09	WATER LEVEL	14.556048
1.63E+09	Turbidity	3000
1.63E+09	Ph	8.2791905
1.63E+09	TEMPERATURE	26.917
1.63E+09	AMMONIA	197.14286
1.63E+09	WATER LEVEL	15.356667
1.63E+09	Turbidity	3000

Figure 3: Data produce by Systems's Sensors

Conclusion

Industrial fish farming is an important supplier of marine protein for human consumption. Yet it is facing many challenges. Future methods for fish farming will therefore need to be more advanced and smarter, in the sense that the industry needs to shift from experience-driven to knowledge-driven approaches to better optimize production. The way to go is to adopt technology to overcome the traditional limitation.

References

- Martin FøreKevin FrankTomas NortonEirik SvendsenJo Arve AlfredsenTim DempsterHarkaitz EguiraunWin WatsonAnnette StahlLeif Magne SundeChristian SchellewaldKristoffer R. SkøienMorten O. AlverDaniel Berckman. (2017). "Precision fish farming: A new framework to improve production in aquaculture,"
- F. O'Donncha and J. Grant, "Precision Aquaculture," in IEEE Internet of Things Magazine, vol. 2, no. 4, pp. 26-30, December 2019.
- Bongiovanni, R., Lowenberg-Deboer, J. Precision Agriculture and Sustainability. Precision Agriculture 5, 359–387 (2004).
- X. Yang, L. Shu, J. Chen, M. Ferrag, J. Wu, E. Nurellari, K. Huang, "A Survey on Smart Agriculture: Development Modes, Technologies, and Security and Privacy Challenges", IEEE/CAA Journal of Automatica Sinica, Vol. 8, p. 273, 2021

IoT SMART GUIDANCE PARKING SEARCH SYSTEM

Iszaidy bin Ismail

Centre of Excellence Advanced Computing, Faculty of Electronic Engineering Technology UniMAP, Arau, Malaysia.
iszaidy@unimap.edu.my

Nur Farhan Kahar¹, Ruzelita Ngadiran¹, Mohamad Hanif Md Saad²

¹Centre of Excellence Advanced Computing, Faculty of Electronic Engineering Technology UniMAP, Arau, Malaysia.

²Institute of IR4.0, Universiti Kebangsaan Malaysia, Bangi, Malaysia
nurfarhan@unimap.edu.my, ruzelita@unimap.edu.my, hanifsaad@ukm.edu.my

Highlights: The invention is an IOT Smart Guidance Parking Search System. This project is developed to guide users in finding the parking spot for their vehicle using web based view based on QR code scanned in the designated area and the camera IOT connectivity. The invention provides a QR code to be scanned and link to a real time updated web for users and a method for camera based parking spot detection and notification. Advantageously, this system and method utilizes a standard camera or CCTV camera to identify parking spots which will be connected to the IOT network and inform the user in the real time web based graphic provided.

Key words: IOT, smart parking, camera, web-based information, Qr code.

Introduction

Finding a parking spot can be a daunting task especially in a high density area. But, thanks to information and communication technology evolution, drivers can more efficiently find satisfying parking spaces with smart guidance parking search. The existing and ongoing works on smart parking are complicated and transdisciplinary. At the same time, in this era of fast data transmission technology over the internet, the Internet of Things (IOT) become famous technology and plays an important role to connect all the sensors and devices together for monitoring, controlling and other purposes. Many applications have been boosted by the implementation of IOT techniques. Parking systems consist of problems related to monitoring and notification, with IOT, this problem can be solved. So IOT based smart guidance parking search system is a way to go.

Many parking areas have already started implementations of smart parking projects (Luque-Vega et al, 2020), with the aim of making driving easier through the installation of sensors and boards informing numbers of parking space availability. This current solution helps drivers to search for parking spaces through information provided however with limited visuals to the driver and expensive cost of sensor installation at each parking spot. Other approaches such as IOT based smart parking utilize the proximity sensor to recognize if the car is present in the parking slot (Dixit et al, 2020) and Simsek et al (2020) propose an IOT based parking with single bit light sensor for detecting the car availability. Overall, many current solutions utilizing IOT for parking space detection require sensor based installation at each parking spot. Thus, what is still needed in the art is a smart guidance parking system that utilizes a minimal sensor for the parking area and by utilizing existing camera or CCTV image, such that parking spot detection and identification can be done and information is sent over the IOT network. Such a system that provides a visual based parking spot detection and notification system is provided by the present invention.

Content

The main objective of this invention is to develop a system for parking guidance based on image processing to provide a real time web update of the parking view and its IoT platform to notify the available parking space from the camera view of the parking area. The driver need to scan provided QR code upon entering the parking area. The information will be sent to the dedicated web to help the driver to find the available parking spot/space. The real time update will enable notification the driver if another driver is leaving the parking area. Besides, the system can be managed by the parking administrator to improve parking initialization and image processing tools are used for the detection of parking space and can be applied to existing CCTV or camera view.



Figure 1 : Web based view and example CCTV view

1. In this work, a camera is attached to the Raspberry Pi to act as a CCTV system. Image processing process applied to the video camera to analyse the parking availability. The parking administrator can also manage during initialization of detection or setup. The presence of the car in the parking slot is tracked with the edge detection and background subtraction. Edge detection is an image processing algorithm that helps to locate the object's borders within an image. The edge detector operates by identifying the discontinuities in luminosity. Laplacian is used on the parking slot for seeking the edges. By integrating the image threshold approach into the code, the threshold is used to separate two regions from the Laplacian average. If the average value is below the threshold, the system can sense the car in the car park and vice versa. And, the system will update the parking slot availability to the web in real time.
2. Figure 1, shows the web to inform if there is a parking spot available. Web based simplified graphic are provided to inform the available parking location. An example of CCTV view shows how parking spots are marked to be assessed for availability. In this work only 6 parking lots are used for initial test as detection and display.
3. The evaluated image information is then sent to the database before the information and notification are sent to the dedicated website.
4. This project can be beneficial to indoor and outdoor parking spots. Suitable for any commercial area.

This work proposes an efficient vision based method of the intelligent parking search system to reduce and overcome the common problem of allocating and guiding in parking spaces areas, especially the area covered by camera view. The smart parking guidance search system provides a safer and more effective solution for parking management. It can assess the availability of parking space by using the image processing system. A smart parking guide search system is user-friendly to both administrators and consumers

References

- Luque-Vega LF, Michel-Torres DA, Lopez-Neri E, Carlos-Mancilla MA, González-Jiménez LE. IoT Smart Parking System Based on the Visual-Aided Smart Vehicle Presence Sensor: SPIN-V. *Sensors*. 2020; 20(5):1476. <https://doi.org/10.3390/s20051476>
- M. Dixit, C. Srimathi, R. Doss, S. Loke, and M. A. Saleemdurai, "Smart Parking with Computer Vision and IoT Technology," 2020 43rd Int. Conf. Telecommun. Signal Process. TSP 2020, pp. 170–174, 2020.
- G. Simsek and M. T. Sandikkaya, "Parking IoT: An IoT Architecture to Collect Availability Data from Parking Lots," 2020 9th Mediterr. Conf. Embed. Comput. MECO 2020, pp. 8–11, 2020.

EARTHCARE APPS DEVICE

Nur Sajida binti Peduka

Universiti Malaysia Kelantan, Kampus Kota
Sajida.h18a0408@siswa.umk.edu.my

**Zakiah binti Taharim, Nur Izzah Amalia binti Hashim, Nur Bashiratul Khalidah binti Ismail Hisyam,
Hazziyati binti Hashim, Fadhilahanim Aryani binti Abdullah**

Universiti Malaysia Kelantan, Kampus Kota
Zakiah.h18a0681@siswa.umk.edu.my, izzah.h18a0391@siswa.umk.edu.my, bashiratul.h18a0368@siswa.umk.edu.my,
hazziyati@umk.edu.my, ariyani.a@umk.edu.my

Highlights: Our team developed the Earth Care Apps device, which is an Apps technology device designed to help outsiders recycle unwanted items. We use the concepts of redo, reuse and resale. This concept can enhance recycling activities, and produce items or tools that can be sold in Earth Care Apps from these recycled materials, and the sales proceeds of recycled items will be donated to those in need. In addition to protecting the environment, we can also maintain the welfare of communities in need and raising public awareness of this recycling activity. We also carry out charity work.

Key words: *Recycle, Redo, Reuse, Resell, Donation, Waste Reuse*

Introduction

The creation of the app of Earth Care is to help the people in Kelantan. Earth care is an app that can help reduce garbage and protect the earth. We use the concept of redo, reuse, and resell. Besides, we also make this Earth Care apps to become a shopping app. We will sell the items that can still be used.

Content

Description of your innovation

The concept of Earth Care is redo, resell and reuse in an application which is a free location-based mobile application that helps the customer across State of Kelantan to recycle their unused item. Our center will receive customer requirements and drive to their designated location as well as pick up the recycled item. We will recycle the unusable items and redo them into usable things as well as selling them. An innovation adding in Earth Care, an online shopping platform that sells the item which is still be able to use and item that we redo using the recycled items that we received from the customers. It is a way to reduce waste and reduce the generation of garbage.

Background of the innovation

The launch of this Earth Care apps is to raise the awareness of people to care for the earth. It is because the garbage that humans produce has been harmful to our environment for a long time. The garbage that generates too much by humans is unable to be disposed of in a sustainable manner. Our seas and landfills are overflowing with waste that is not biodegradable or cannot be recycled adequately. People continue to generate a vast amount of rubbish and fail to properly dispose of it. It will cause environmental pollution as well as puts human health at risk. In order to prevent this from getting worse, we create Earth Care apps to dispose of the recycled items they do not want. Earth Care apps does not only help customers to deal with their unused items but also increase their environmental awareness. Furthermore, it also deals with the unused item in the right way for environmental protection and save the earth.

Why are they important to education?

Earth Care plays a very important role in education. Earth Care can increase people's awareness of how to collect, sort and dispose of materials that can be used as raw materials. It ensures that these materials do not become waste and ultimately damage the environment and allow people to identify habits that contribute to the environment. Earth Care also provides people with the knowledge to reduce waste by using materials that have already been used as raw materials, thereby ultimately reducing pollution. Earth Care raises people's awareness of environmental issues through the form of education, enabling people to further study sustainable options and change their negative attitudes towards conservation. It is important that people must be educated about the impact of human activities on the environment so that they can take sustainable actions to protect the environment.

Advantages of your innovation Towards Education and Community

Our idea is to increase awareness for a redo, reuse and resell across residents in Kelantan. Not only can enhance the awareness for the environment of the community but also make them have a minimalism living. In addition to this, for the redo and reuse, there is the concept that reduces waste as well as reduces environmental pollution. Recycling education is a critical link in the chain of environmental stewardship and long-term community

development. It requires everyone in a community to commit to cleaner, more environmentally friendly behavior. Thus, recycling contributes to the well-being of a community. It is because recycling initiatives can help to keep the environment healthy and clean for a community. For the resell, this is one of the concepts that help people in need. It is because some of the profits that is earned from the selling redo items or the secondhand items will be donated to the people who need help.

Commercial value in terms of marketability or profitability of your innovation

Earth Care is buying the recycle item from customer and sell the redo or recycle item at an online shopping platform for the needy. The item has a bargain price, which also allows customers to buy these needed items at a low price. Earth Care solves and packs recycling items more conveniently. The buying and selling platform allow more customers to buy second-hand things instead of buying new things and it reduces the waste of more resources on the planet.

Acknowledgement

Many thanks and well done to the innovative members for successfully contributing ideas in producing an application that is Earth Care Apps. Not only that, we would like to thank our team members who gave their full commitment and enthusiasm while doing this group assignment. Without cooperation, understanding and tolerance, the task of this group cannot be completed in a timely manner.

References

- Husna, A., Safitri, A. I., Darmawi, D., Azwar, A., & Reyaldi, F. The Influence of Knowledge and Support of Community Leaders in the Application of 3 R (Reduce, Reuse, Recycle) in Household Waste in Johan Pahlawan District, Aceh Barat District. *JournalNX*, 6(06), 611-619.
- Ilangoan, P., & Meena, K. (2016). APPs on e-Governance for Solid Waste Management. *International Journal of Computer Science Engineering (IJCSE)*, 5(4), 212.
- Kaburuan, E. R., & Heriyati, P. Mobile Apps Business Design and Development for Integrated Waste Management.

APC-BUS: AUTOMATED PASSENGER COUNTING FOR INTELLIGENT BUS TRANSPORTATION SYSTEM

Aimi Salihah Abdul Nasir

Faculty of Electrical Engineering Technology, Universiti Malaysia Perlis, Perlis, Malaysia
aimisalihah@unimap.edu.my

Muhammad Rizal Farhan Shaik Osman, Muhammad Izuan Fahmi Romli, Marni Azira Markom

Faculty of Electronic Engineering Technology, Universiti Malaysia Perlis, Perlis, Malaysia
rizalfarhan123@gmail.com, izuanfahmi@unimap.edu.my, marni@unimap.edu.my

Highlights: The APC-BUS is an innovative product that is specially engineered to count the number of passengers inside the bus. This system utilizes image processing technique based on face detection in order to count the number of passengers and enhance the robustness of the detection accuracy. By incorporating the system, passengers can preview the live occupancy status that is displayed on the bus. In addition, the live occupancy can also be accessed through the designated mobile phone apps integrated with Wifi and GPS, ultimately, the system allows the passengers and the bus manager to locate vehicles in real time.

Key words: *Passengers Counting, Face Detection, GPS Tracker, Bus Fleet Management*

Introduction

The outbreak of the COVID-19 has made automated passenger counting more important than ever. As is well known, the buses are usually used by the industry workers with working hours based on shifts. This is because most of the large industries require work shifts for continuous round-the-clock coverage to optimize output and productivity. Having said that, it is estimated that the average industry workers in a multinational company are accounted for 2000 to 4000 workers.

On accounts of the current situations due to COVID-19, it is necessary to enhance social distancing as recommended by the government. However, to ensure effective social distancing among the onboard passengers is difficult because of overloaded industry workers. Consequently, most company buses frequently get overcrowded especially as the workers rush to board the bus simultaneously.

Additionally, the passengers are unaware of the bus occupancy status prior boarding and the estimated time for the bus arrivals. In consequence, most of the passengers decided to aboard the first bus simultaneously until it gets overcrowded to its full capacity as it is hard to ascertain the arrival time of the next bus. More importantly, some passengers may become intolerant and act aggressively in competing for a seat in the bus. Therefore, with a cost less than RM1k, APC-BUS offers several benefits and can be commercialized to industry.

Content

The APC-BUS is an innovative product that is specially engineered to count the number of passengers inside the bus. This system utilizes image processing technique based on facial detection in order to count the number of passengers and enhance the robustness of the detection accuracy. By incorporating the system, passengers can preview the live occupancy status that is displayed on the bus and allowing the awaiting passengers to decide whether to ride the bus or skip for the upcoming bus. The live occupancy can also be accessed through the designated mobile phone apps integrated with wifi and GPS, ultimately, the system allows the passengers and the bus manager to locate vehicles in real time. In the app, the real-time location tracking of the bus is provided alongside the estimates on the number of passengers riding on the bus. This is particularly rewarding to the passengers to predict the estimated time of arrivals (ETA) and be informed if the anticipated bus is overcrowded. Hence, the passengers do not have to rush to board the bus. Figure 1 presents the automated passenger counting for intelligent bus transportation system.

Based on the descriptions of this system earlier and with a cost less than 1K, APC-BUS offers several benefits and can be commercialized to industry. APC-BUS will ease the industry worker to choose the correct bus based on empty seat display on the bus. The ability of this system to show live occupancy figures in vehicles helps passengers to follow the social distancing recommendations while using public transport. Moreover, APC-BUS also provides real-time tracking which will help bus manager to monitor number of passengers on board and locate the current location of the buses to ensure the safety of passengers. It's unlikely that coronavirus will be completely eradicated in the near future. This means that extra precautions against the spread will remain a high priority. Looking ahead, when social distancing is behind us, attention will be given to lessen the impact of any future novel contagions.



References

- Nasir, A. S. A., Gharib, N. K. A., & Jaafar, H. (2018, August). Automatic Passenger Counting System Using Image Processing Based On Skin Colour Detection Approach. In 2018 International Conference On Computational Approach In Smart Systems Design And Applications (ICASSDA) (pp. 1-8). IEEE.
- Husin, M. S. C., & Nasir, A. S. A. (2021). Automatic Passengers Counting System Using Images Processing Based on YCbCr and HSV Colour Spaces Analysis. In Proceedings of the 11th National Technical Seminar on Unmanned System Technology 2019 (pp. 853-872). Springer, Singapore.

SMART INTERNET-OF-MEDICAL WEARABLE WATCH FOR EARLIER SYMPTOMS DETECTION, MONITORING AND TRACKING OF COVID-19 PATIENTS

Naimah Yaakob

Advanced Computing, Centre of Excellence (AdvComp),
Faculty of Electronic Engineering Technology, University Malaysia Perlis, Perlis, Malaysia
naimahyaakob@unimap.edu.my

Nik Adilah Hanin Zahri¹, Siti Hajar Bt Abdul Rahman¹, Riza Nur Arissha Bt Mohd Sabri¹, Devendran A/L Ramesparan¹, Siti Nur Aisyah Bt Azara'ai¹, Mahathir Almashor²

¹Faculty of Electronic Engineering Technology, University Malaysia Perlis, Perlis, Malaysia

²CSIRO/Data61 and Cyber Security Cooperative Research Centre, Marsfield, Australia

adilahhanin@unimap.edu.my, s181021176@studentmail.unimap.edu.my, s181021169@studentmail.unimap.edu.my,

s181021041@studentmail.unimap.edu.my, s181021179@studentmail.unimap.edu.my,

mahathir.almashor@data61.csiro.au

Highlights: This project has developed a way to remotely monitor and provide early detection of COVID-19 symptoms using smart watches and Internet-of-Medical-Things (IoMT) technology. This wearable watch detects symptoms and notifies healthcare professionals without the need for direct contact. This minimizes risks to caregivers and reduces the spread of the virus, which is crucial in both flattening the nation's infection curve and limiting disease morbidity and mortality. Results show that the smart watch in conjunction with the proposed system can effectively detect COVID-19 symptoms, signalling the project's high potential to aid in the nation's pandemic response.

Key words: COVID-19 Symptoms Early Detection, Wearable Devices, Healthcare Monitoring.

Introduction

The ongoing Coronavirus Disease 2019 (COVID-19) global pandemic is at a critical juncture, with new variants posing serious threats to public health. It has caused more than 187 million confirmed cases, with more than 4 million deaths as of July 2021 marking it as the deadliest pandemic in history (WHO, 2021). This unprecedented disease has severely strained the healthcare systems of even developed nations as they faced sudden surges. In addition, we have also witnessed instances of healthcare collapse in various countries. Moreover, as new variants speed up the infection rates, hospital facilities and resources are over consumed, which exacerbates higher mortality rates. The currently used conventional reverse transcription-polymerase chain reaction (RT-PCR) technique in COVID-19 detection endures with some inevitable limitations (Abhijeet et. al., 2021). Consequently, the establishment of reliable detection and monitoring system for earlier detection of COVID-19 symptoms is essential for effective prevention and to contain a growing public health crisis.

Significance

One of the main challenges facing health authorities is that they have to diagnose patients without knowing if they have already been infected. A patient may already be in the infectious stage, which is risks transmission to attending medical staff. Remote and early detection of infections is important to mitigate disease spread through self-isolation, contact restriction and effective treatments. A recent study (Mishra et. al., 2020) have shown that elevated heart rate measurements from smartwatches can be used in epidemiological studies to track the spread of respiratory viruses. Moreover, since most infections become apparent only upon symptoms onset, current testing methods cannot identify pre-symptomatic carriers, which is a significant challenge for the implementation of early-stage interventions that reduce transmission. It is believed that as much as 50% of COVID-19 cases are asymptomatic, facilitating further viral spread. Hence, this project makes use of body temperature, heart rate and blood oxygen levels (SpO₂) which are key indicators that can help detect COVID-19 infection.

Product Description, Novelty and Innovation

This project embodies the concept of COVID-19 symptoms detection driven by Internet-of-Medical-Things (IoMT). The novelty lies in the development of a wearable smartwatch that integrates with a Firebase cloud and real-time web-based monitoring system specifically tailored for COVID-19 detection. Our system can be divided into five distinct phases as shown in Figure 1(a) and the system prototype is illustrated in Figure 1(b). The 1st phase consists of data acquisition where vital signs from patients' smartwatches are collected at home and sent to a centralized cloud to power a multi-tiered alert system to doctors. This is made feasible by the use of sensors for temperature (DS18B20), heart rate & SpO₂ (MAX30100). These rudimentary yet key signals can infer the general state of a person's health.

Subsequently, Phase 2 initiates COVID-19 symptoms detection using Raspberry Pi which then classifies the data into three conditions (low, medium and high risk). The aim here is to detect prolonged readings outside of pre-defined safe thresholds which can be inferred as potential symptoms of COVID-19. These classifications can also significantly guide medical staff on the appropriate level of action to be taken on infected patients.

Phase 3 involves alerts and notifications once dangerous thresholds are exceeded. This is done using LED, buzzer and an SMS module (SIM900A GSM). Upon exceeding any normal threshold and classified as high risk for over 5 times, SMS alert will be sent directly to the doctor in-charge. As shown in the figure, the sensor attached to a patient's finger is used to measure body temperature, with normal temperature identified as between 36 to 37.2

degrees (Celsius). Abnormal conditions are defined as anything other than within this range. Conversely, the sensor to measure the patient's heart rate has a normal range from 60 to 85 beats per second (b/s). Readings out of this range are considered critical to patient health as it may cause brain lesions to form in the target patient demography.

Moreover, Phase 4 emphasizes on cloud integration in which data will be securely uploaded into the Firebase cloud via HTTPS. Data transmission using HTTPS is crucial to protect sensitive information related to medical data. Finally, Phase 5 entails the development of Healthcare Monitoring System (HMS) for data analysis through cloud analytics. Real-time sensed data is continuously fed into the Firebase database, and updated in the HMS to be used by doctors for further diagnosis. This system also features graph visualization and patients' historical data which allows for timely diagnosis of symptoms, without the need for ever-present medical staff. Doctors can directly observe whether the patient is in a high, mild or low risk based on data classification done on the microprocessor. For high-risk patients, immediate further actions can be taken by either urgently moving them to medical facilities via ambulance, or by calling on local health staff to further inspect patients. This system is also accessible by patients to monitor their own status and to make appointments with doctors. They can also see their prescriptions, and check whether their appointments are approved or if they should follow alternative medical instructions.

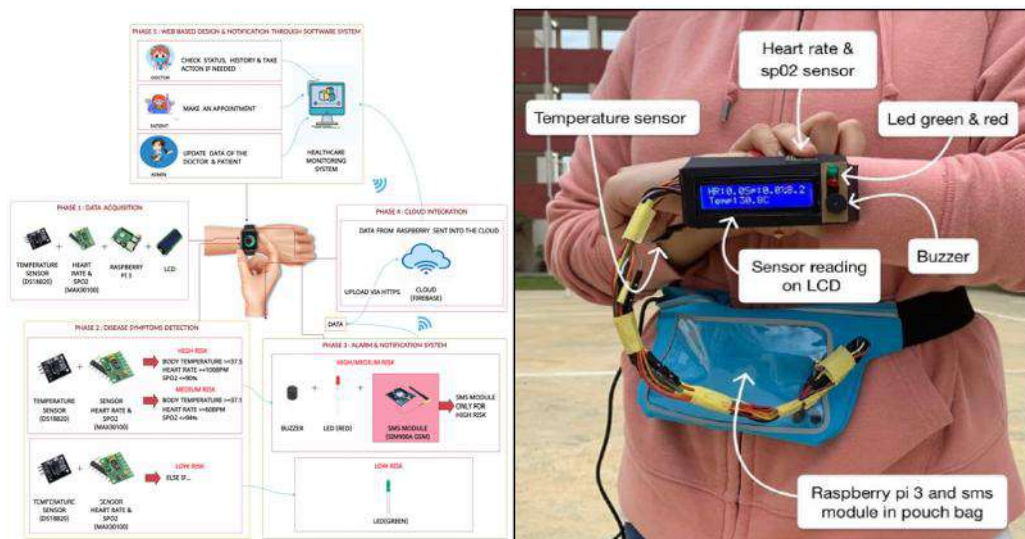

Figure 1: (a) System Overview (b) Project Prototype

Advantages towards community

Collectively, the proposed IoT smart watch and the developed HMS features would be useful to rapidly and safely detect COVID-19 patients. This will ameliorate the spread of viral infections during the current pandemic and allow greater control by health authorities. This will also limit community transmission and hence reduce the morbidity and mortality rates in the whole world. In Malaysia, this detection system will greatly help the management of COVID-19, protect our front-liners, and assist in timely disease containment.

Commercial value in terms of marketability or profitability

Due to rapid spread of coronavirus, earlier detection of symptoms can greatly reduce the spread of the disease, and provide timely intervention before it severely affects patients' health. Therefore, the developed product and system has a high commercialization potential due to its relatively low cost, operational simplicity, and ability to reduce the workloads of healthcare professionals, and ultimately save lives.

Acknowledgement

The work has been partially supported by the Cyber Security Research Centre Limited whose activities are partially funded by the Australian Government's Cooperative Research Centres Programme.

References

- WHO, "Coronavirus disease (COVID-19) pandemic" <https://www.who.int/>. accessed by 15th July 2021.
- Mishra, T., Wang, M., Metwally, A.A. et al. Pre-symptomatic detection of COVID-19 from smartwatch data. *Nat Biomed Eng* 4, 1208–1220 (2020). <https://doi.org/10.1038/s41551-020-00640-6>.
- Abhijeet Mohanty, Adarsh P. Fatrekar, Saravanan Krishnan, Amit A. Vernekar, A concise discussion on the potential spectral tools for the rapid COVID-19 detection, *Results in Chemistry*, Volume 3, 2021, 100138, ISSN 2211-7156, doi.org/10.1016/j.rechem.2021.100138

VISION BASED SMART GRIPPER FOR MATERIAL HANDLING USING INTERNET OF THINGS

Hasimah Ali

Universiti Malaysia Perlis, Arau, Malaysia
hasimahali@unimap.edu.my

Muhammad Irfan Zainur, Tan Yin Suan, Mohamed Elshaikh

Universiti Malaysia Perlis, Arau, Malaysia
irfanzainur97@gmail.com, tanys409@gmail.com, elshaikh@unimap.edu.my

Highlights: Robotic grippers have becoming an emerging trend due to their boundless applications in industrial automation. Grippers used to operate with industrial robots for various material handling and also manipulation of objects. Nowadays, deployment of vision based smart gripper for material handling in industrial applications remains challenging and ongoing research. As Internet of Things (IoT) becomes more commercialized, various concept of IoT have been integrated with the gripper due to efficient usage. Therefore, this project proposes the development of vision-based sensor of smart gripper for material handling in industrial applications that integrates with internet of things (IoT). The rationale of integrating IoT to vision based smart gripper is that it allows authenticated users to login from any device, anywhere, and view video or images from vision based smart gripper in real-time for critical material handling. This system incorporates a camera by means vision sensor to act as "eye" to automatically detect and recognize the object that having different weight and shapes and send the information to the robot for next task. Gripper with two fingers have been constructed. This smart gripper adopts force sensor that mounted into the fingertip in order to control the force applied when working with wide range of objects that having different weight. In electronic system, power module, communication and control module, sensor and actuator as well as user interface module have been adopted and integrated into the system. Besides, in software development system, user interface configuration was developed through mobile application in which it communicates with Raspberry Pi B+ camera to serve as IoT platform. A series of experiments shows that the vision based gripper using IoT able to detect and recognize the objects and then send the information/command directly to the robot to execute grasping and lifting phase of the object to the desired location that has been assigned.

Key words: *Vision based, Smart Gripper, Internet of Things.*

Introduction

Robotic gripper is widely used for different tasks in various fields. Grippers operate with industrial robots for handling and manipulation of objects. Grippers also operate with hard automation for assembling; micro assembling, machining and packaging. Nowadays, deployment of vision based smart gripper for material handling in industrial applications remains challenging and ongoing research (Yang et. al, Ali et. al]. As Internet of Things (IoT) becomes more commercialized, various concept of IoT have been integrated with the gripper due to efficient usage. Therefore, this project proposed the development of vision-based sensor of smart gripper for material handling in industrial applications. The rationale of integrating IoT with smart gripper is that it allows authenticated users to login from any device, anywhere, and view video or images from vision based smart gripper in real-time for critical material handling. This system incorporates a camera by means vision sensor acts as "eye" to automatically detect and recognize the object that having different weights and shapes and send the information to the robot for next task. Gripper with two fingers has been constructed. This smart gripper adopts force sensor that mounted into the fingertip in order to control the force applied when working with wide range of objects which having different weights without crushed or damaged it. In electronic system, power module, communication and control module, sensor and actuator as well as user interface module have been adopted and integrated into the system. Beside, in software development system, user interface configuration was developed through mobile application in which it communicates with Raspberry Pi B+ camera to serve as IoT platform. A series of experiments shows that the vision based gripper using IoT able to detect and recognize the object and then send the information/command directly to the robot to execute grasping and lifting phase of the object to the desired location that has been assigned.

Content

Figure 1 shows the flowchart of the product development. The system starts when the user gives a command to the mobile application, which then will be sent to the server through a wireless connection of IoT platform. Then, Raspberry pi, which receives the control signal, will initiate the robot vision system to capture the image of objects from the working area. The image taken is processed to detect if there are objects in the working frame. The system will only start to identify the shape, size, and colour of objects if objects are detected. After that, the system will calculate the x, y, and z coordinate of objects from the image coordinate. Raspberry pi will then send the object coordinate to the Arduino controller through serial communication to convert the y and z coordinates into servo angle and step conversion. The Servo motor will move the robot arm to the location of the detected objects. The

smart gripper will grip the object with a suitable force and proceed to do pick and place operation. The system will end until all objects are picked. Figure 2 shows the vision based smart gripper based IoT hardware development.

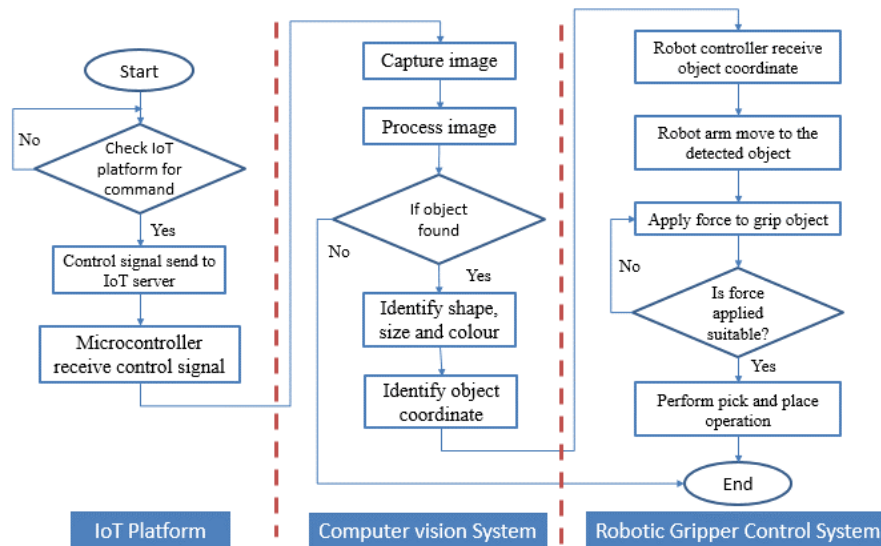

Figure 1: The flowchart of the product development

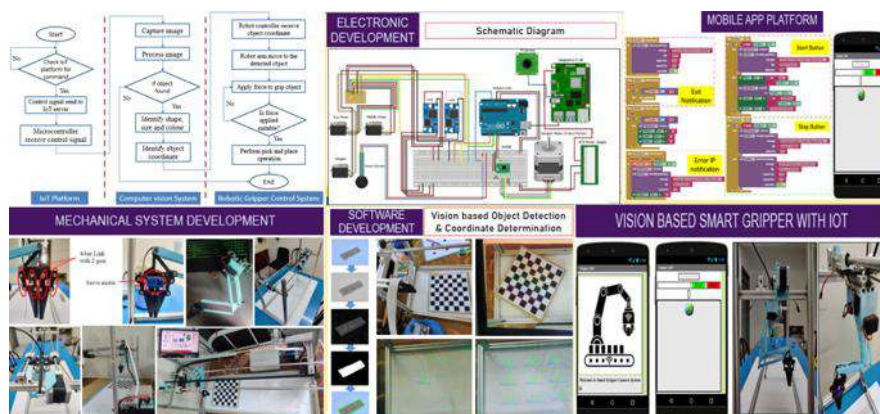

Figure2. Overall vision based smart gripper based IoT development for material handling.

Commercialization Potential. The vision based smart gripper based IoT has potential commercialization in automation industry for critical material handling (e.g. micro-assembling, machining, packaging in line with industrial revolution IR 4.0).

Novelty. Development of vision based smart gripper using IoT allows the authenticated users to login from any device, anywhere, and view video or images from vision based smart gripper in real-time for critical material handling with appropriate grasping force.

Innovation Impact. Vision based smart gripper using IoT provides innovation impact for automation industry (industry IR 4.0) aligns with SDG agenda in Malaysia (Goal 9) that help industry players to build resilient infrastructure in material handling.

References

- Yang L., Wu S., Lv Z., and Lu F.(2020). Research on manipulator grasping method based on vision. 2019 MATEC Web Conf.Volume 309. 2019 International Conference on Computer Science Communication and Network Security.
- Ali M. H., Aizat K., Yerikhan K., Zhandos T., and Anuar O.(2018). Vision-based Robot Manipulator for Industrial Applications. *Procedia Comput. Sci.*, vol. 133, pp. 205–212, 2018, doi: 10.1016/j.procs.2018.07.025.
- Malaysia Sustainability Development Goal Voluntary National Review 2017.

CUSTOMIZED RAINFALL COLLECTOR FOR ISOTOPE ANALYSIS
(²H, ¹⁸O, TRITIUM)**Roslanzairi Mostapa**Malaysia Nuclear Agency, 43000 Kajang, Bangi, Malaysia
roslanzairi@nuclearmalaysia.gov.my**Kamarudin Samuding¹, Mohammad Muqtada Ali Khan², Zakiyah Ainul Kamal², Hafzan Eva Manosor²,
Nor Shahida Binti Shafiee @ Ismail², and Aweng A/L Eh Rak²**¹Malaysia Nuclear Agency, 43000 Kajang, Bangi, Malaysia²Department of Geoscience, Faculty of Earth Science, Universiti Malaysia Kelantan, Campus Jeli, Locked Beg No
100, 17600 Jeli, Kelantan, Malaysiaksamudin@nuclearmalaysia.gov.my, muqtada@umk.edu.my, zakiyah.ainulkamal@gmail.com,
hafzan.eva@umk.edu.my, shahidashafiee@umk.edu.my, aweng@umk.edu.my

Highlights: The setup of the rainwater collection apparatus suitable for for isotope analysis (²H, ¹⁸O, Tritium) is by using tube–dip–in–water totalizer collector with pressure equilibration for excellent evaporation protection. A stainless steel table–tennis–sized–ball and debris screen is placed in the collection funnel for extra protection against evaporation and to help in sealing the collector bottle against any debris, respectively. Another advantage of using this type of collector is it facilitates low–cost unattended monthly sampling and eliminates the need for paraffin oil.

Key words: Rainfall, collector, isotope, analysis

Introduction

In general, the main precautions in precipitation sampling for isotopic analysis are evaporation prevention or exchange with atmosphere and representativeness of the sample to ensure reliable isotopic data. Sample evaporation may occur during sample collection as the collector is left for one month on site and open exposure of a precipitation sample to the atmosphere can result in evaporation that can alter the isotopic composition of the water sample. Rainwater sample collected should represent the integrated natural precipitation of the targeted sampling period which is one calendar month. Rainwater flowing out of a collector from extreme rain events such as monsoon may also result in loss of an important part of a month's precipitation (IAEA, 2014). All these concerns led to the invention of this rainfall collector. The setup of the rainwater collection apparatus suitable for this purpose is by using tube–dip–in–water totalizer collector with pressure equilibration for excellent evaporation protection. A stainless steel table–tennis–sized–ball and debris screen is placed in the collection funnel for extra protection against evaporation and to help in sealing the collector bottle against any debris, respectively. Another advantage of using this type of collector is it facilitates low–cost unattended monthly sampling and eliminates the need for paraffin oil. The rain gauges were placed at the sampling area in the rainfall stations compound on the first day of every month and the monthly accumulated samples or composite samples of precipitation were emptied at the end of the month. The disadvantage of this collector is the amount of rainfall need to be determined volumetrically when there is no rain amount recorder on site. However, the rain amount can be estimated using the equation below:

$$\text{Rainfall amount (mm)} = \frac{10V}{\pi r^2}$$

Where, V = volume of rainwater collected (ml) and r = funnel radius (cm). The bottle size used in this setup is 20L to ensure that the accumulation bottle is capable of accepting all the rainwater collected during the sampling period taking into account the possibility of extreme events (e.g. monsoons). The collector should be mounted approximately 30cm and 1m above ground in natural and developed areas, respectively to reduce the impact of wind turbulence and nearby structure. This method compared favourably with the paraffin oil and performed better than collecting daily rain gauge samples overall (Hughes, 2013) and highly recommended by the International Atomic Energy Agency (IAEA, 1983) due to the advantages mentioned above.

Operating Mechanism

Rainwater enters the collector through the funnel. As the rainwater accumulates, the stainless steel ball will float thus allowing the rainwater to flow down into the collector. The stainless steel ball will act as the first line of defense against evaporation as it return to its original position and therefore sealing the upper part of the funnel hole. When rainwater reaches the bottom part of the collector, the second phase of evaporation prevention mechanism immediately takes place as the water hose end will be submerged. This water hose end is kept in place with the help of the weight. Since the collector will be left for one month at the sampling site and water level will rise when it rains, the long small tubing will equilibrate the pressure inside the collector and further minimizes the evaporation of the water sample.

Pro

Cheap, robust and practical/easy to use.

Con

The prototype lack of aesthetic value.



Figure 1: Above pictures showing setup of rainfall collector

Table 1: Comparison of rainwater measurement results between old collector and new collector.

Year	Old Collector ¹		New Collector ²		D	
	d ¹⁸ O (‰)	d ² H (‰)	d ¹⁸ O (‰)	d ² H (‰)	d ¹⁸ O (‰)	d ² H (‰)
2016						
Jan	-3.85	-22.81	-3.94	-22.67	0.09	0.13
Feb	-0.90	-8.65	-2.94	-11.10	2.03	2.45
Mar	-2.28	-8.37	-3.89	-11.01	1.62	2.64
Apr	-3.17	-18.86	-4.46	-21.42	1.29	2.56
May	-6.78	-39.48	-6.86	-41.66	0.08	2.18
Jun	-9.21	-70.45	-12.71	-69.50	3.50	0.95
July	-9.46	-60.75	-10.99	-62.88	1.54	2.14
Aug	-6.85	-23.67	-4.23	-30.13	2.62	6.46
Sept	-6.05	-33.78	-8.11	-43.62	2.06	9.84
Oct	-6.66	-47.11	-7.43	-50.67	0.77	3.56
Nov	-10.40	-66.62	-9.47	-67.86	0.93	1.25
Dec	-9.92	-66.72	-8.86	-72.65	1.06	5.93
				Avg	1.46	3.34

¹Old collector using paraffin as evaporation prevention mechanism.

²The new Tube-dip-in-water totalizer collector with pressure equilibration.

Acknowledgement

The authors are grateful to the International Atomic Energy Agency (IAEA) for endowing with basic facilities and support to carry out the present project. The financial assistance received from Fundamental research Grant (R/FRGS/A0800/00644A/003/2018/00556) are highly acknowledged.

References

IAEA (International Atomic Energy Agency) (2014) IAEA/GNIP precipitation sampling guide. Vienna: IAEA.
 Hughes, C. E., Crawford, J., (2013) Spatial and temporal variation in precipitation isotopes in the Sydney Basin, Australia. Journal of Hydrology, 489: 42–55.
 (IAEA) (International Atomic Energy Agency) (1983) Guidebook on nuclear techniques in hydrology. 1983 Edition, Technical Report Series No. 91, Vienna: IAEA.

SUPRIMA S5

Mohd.Zulkafli Bin Mohamed

Politeknik Kota Bharu, Kota Bharu, Malaysia
mohd.zulkafli@yahoo.com

Tengku Azmie Bin Raja Hassan, Muhamad Shah Rul Bin Kamaruddin, Ahmad Suhaimi Bin Arshad, Wan Amiruddin Bin Wan Mustapha

Politeknik Kota Bharu, Kota Bharu, Malaysia
mohd.zulkafli@yahoo.com, shahrul@pkb.edu.my, suhaimi@pkb.edu.my, amiruddin@pkb.edu.my

Highlights: The Internet of Things (IoT) application is used as the primary medium to improve the level of vehicle safety in developing the Proton Innovation system. All systems have been successfully completed and certified. The Thumbprint System (TPS) is a fingerprint scan to activate the electronic system on the vehicle. Once the fingerprint is approved, the driver can then turn on the engine. Only registered owners and users can turn on the engine. In the case of an out-of-control situation such as theft, then the owner can stop the vehicle using a smartphone.

Key words: Internet of Things, safety, and security

Introduction

The Internet of Things (IoT) application is used as the primary medium to improve the level of vehicle safety in developing the Proton Innovation system. All systems have been successfully completed and certified. The Thumbprint System (TPS) is a fingerprint scan to activate the electronic system on the vehicle. Once the fingerprint is approved, the driver can then turn on the engine. Only registered owners and users can turn on the engine. In the case of an out-of-control situation such as theft, then the owner can stop the vehicle using a smartphone. The Car Tracking System (CTS) will keep track of vehicles with the help of hidden cameras. The built-in security system is implemented by transmitting the burglar image and current vehicle location to the owner and authorities via emails. In terms of safety for the user, the Vehicle Carbon Monoxide Detector System (VCOD) works with the vehicle window to open ¼ automatically when detecting monoxide gas inside the cabin. Meanwhile, the Alcohol Detection System (ADS), acts as an alcohol detector on the driver while driving or before commuting. This situation will prevent accidents caused by driver driving under the influence of alcohol. This function is activated by avoiding the engine from being switched on as long as the sensor detects the presence of alcohol on the driver's breath. NGV Leakage Detector (NGVD) will detect NGV gas leakage which will prevent vehicles from burning due to leakage, as drivers will be alerted through buzzer sound and display on LCD screens.

Content

SUPRIMA S5 with 5 innovation of Safety and Security System, developed innovation for the SUPRIMA S5 System as figure 1.

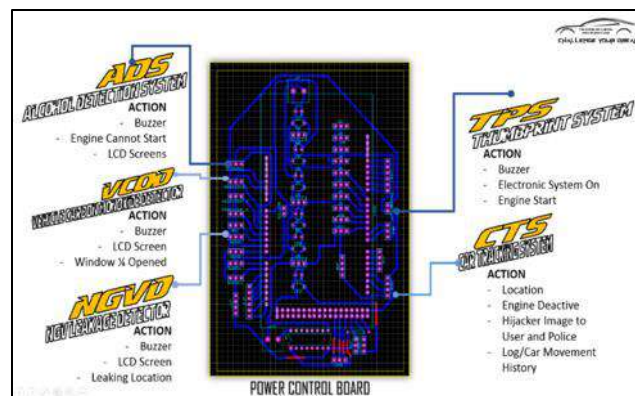

Figure 1 : SUPRIMA S5 System Developed

For the purpose of connecting the system that has been developed with the original system of the vehicle can be seen the schematic circuit in figure 2. Where the Wiring Harness on the Proton SUPRIMA S has been connected to the system via socket C32 and into the Power Distribution Board (PDB) of the system, this connection can be seen more clearly in Figures 3 and 4. In addition to the PDB the position of the relay on the circuit can also be seen in fig. The developed system is coordinated on the system via the Power Unit on the SUPRIMA S.

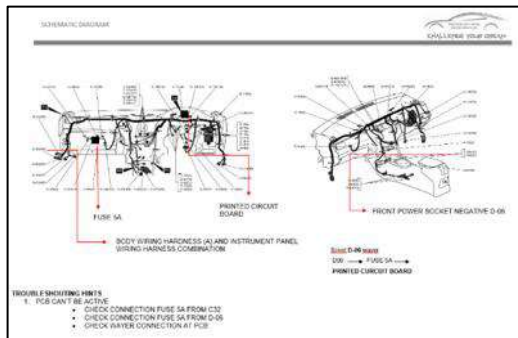

Figure 2: SUPRIMA S5 Schematic Circuit

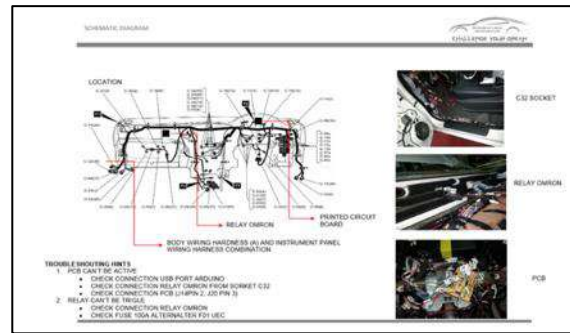

Figure 3: SUPRIMA S5 System Positioning

Effectiveness and achievement

This innovation has won a gold medal during the Proton Polytechnic (PiPPo) Innovation Competition and Exhibition 2019, apart from that, SUPRIMA S5 is also a contributor to the invaluable marks for the APACC Audit and also the ETAC at PKB. This innovation is also used as a teaching aid for several courses for students to better understand the vehicle system.

Conclusion

The production of SUPRIMA S5 can be used as one of the platforms for the dissemination of knowledge for the target group, especially outsiders. This is through exhibitions and demonstrations held outside the polytechnic area to be displayed to outsiders. In this way, the potential for disseminating knowledge to external parties about these vehicles and the potential for use in the PnP process can be explained more openly.

Apart from that, this SUPRIMA S5 can be used as a promotional material especially to attract the interest of prospective polytechnic graduates to continue their studies here.

Apart from that, the potential to be disseminated to outsiders can also happen starting from the production process of this SUPRIMA S5 again where students visit the industry center and exchange opinions to produce this SUPRIMA S5.

Through the development of SUPRIMA S5, students can also indirectly participate in high -impact innovation programs. With this participation forms the identity of students to think in a more creative and innovative direction. Exhibition or any activity involving the use of this SUPRIMA S5, it also has the potential to be the next public gaze the potential for the dissemination of knowledge about the production of this machinery by students and the benefits from it can be known.

VCOD - Vehicle Carbon Monoxide Detector System

NGVD - System detection of Carbon Monoxide gas inside the cabin

CTS - Car Tracking System

TPS – Thumb Print System

ADS – Alcohol Detection System

References

- Arkadiusz Spiewak dan Wojciech Salabun (2015). A Mobile Gas Detector With an Arduino Microcontroller. *International Journal of Computer Applications in Technology*. 6(4) 636-641, August 2015, ISSN:2229-6093
- A.Mahalingam dan R.T. Naayagi (2012). Design and implementation of an Economic Gas Leakage Detector. Conference paper. 6th International Conference on Circuits, System and Signal.
- C.O Folorunso, L.A.Akinyemi, A.A.Ajasa dan Oladipupo Kazeem (2015). Design and Development of Fingerprint Based Car Starting System. *International Conference and Exhibition on Power and Telecommunications*
- Karthikeyan.a dan Sowndharya.j (2012). Fingerprint Based Ignition System. *International Journal of Computational Engineering Research*. Mar-Apr 2012, Vol. 2, Issue No.2, 236-243 Page 79
- Mohammad Faizul Bin Sabawi (2009). *Vehicle Tracking System Using GPS And GSM Technology* . Tesis Sarjana Muda, Universiti Teknikal Malaysia Melaka.
- Mutasem El-Fadel dan Layale Abi-Esber (2009). In-vehicle Exposure to Carbon Monoxide Emissions from Vehicular Exhaust. *Critical Reviews in Environmental Science and Technology* 39(8): 585-621, August 2009, DOI: 10.1080/10643380701798264
- Pranjali Ingalepatil, Priyanka Barhate, Bhagyashri Nemade dan Vijay D. Chaudhari (2017). Alcohol Detection System in Vehicle Using Arduino. *International Research Journal of Engineering and Technology*. Volume: 04, Issue: 06, June 2017. e-ISSN:2395-0056
- Pratiksha Bhuta, Karan Desai, Archita KeniGuide dan Vijayalakshmi Badre (2015). Alcohol Detection and Vehicle Controlling. *International Journal of Engineering Trends and Applications*. Volume 2 Issue 2, Mar-Apr 2015, ISSN: 2393 9516
- Sneha Kamble, Chinmaya Godbole, Rohini Gaikwad dan A.P.Yadav (2016) . Vehicle Tracking System. *International Journal for Innovative Research in Science & Technology*. Volume 2, Issue 11, ISSN: 2349-6010

SCIENTIFIC WRITING PAPER MANAGEMENT INNOVATION "I-REVIEW"

Hasanah Binti Safein @ Shafie

Politeknik Kota Bharu, Kota Bharu, Malaysia
hasanah@pkb.edu.my

**Ira Fazlin Bin Mohd Fauzi, Muhammad Daniel Nafis Bin Ahmad, Muhammad Yahya Bin Mat Rashid,
Wan Mohamad Fikri Bin Wan Shahrudin**

Politeknik Kota Bharu, Kota Bharu, Malaysia
ira@pkb.edu.my, modanafis@gmail.com, emberspirit290@gmail.com, wanmhdfikri2391@gmail.com

Highlights: Digest@JMSK publication is the result of research writing produced by lecturers and students throughout the Polytechnics, Community Colleges and Institutes of Higher Learning Malaysia which covers areas related to research in accordance with the set standards. In addition, the research results of this digest book are to meet the requirements of education, technology, engineering, management and marketing. In order to produce quality research books, researchers need to produce articles on promotion excellence criteria for lecturers in polytechnics. Several research activities have been implemented in stages to collect the results of writing to be included in this book Digest@JMSK. Every piece of writing produced needs to be reviewed and refined before printing and distribution is done. It is hoped that this publication will cultivate interest and provide exposure to lecturers and students towards research and innovation globally. Research and Scientific Writing Paper Management Innovation www.digestjmsk.com is built to facilitate the process of management and print production of a quality scholarly writing article.

Key words: *scientifically, management, writing, articles*

Introduction

These Extended Abstracts are not single abstracts or proposals of intention but should include all the information f Digest@JMSK publication is the result of research writing produced by lecturers throughout Polytechnics, Community Colleges and Institutes of Higher Learning Malaysia which covers fields related to education, technology, engineering, management and marketing. In order to produce quality research books, researchers need to produce research articles that follow the set standards. Through the development of the digestjmsk website can help in managing the results of writing articles in a planned and systematic manner for the purpose of publishing digest regularly every year.

Content

Innovation Details

This website was developed using the wordpress.com website. Users can 'access' the login by typing 'www.digestjmsk.com'. The website contains 7 menu views such as Home, Info Digest, and Call for Paper, Registration, Writing Format, Contact Us, Reviewer Evaluation and Article List. Users can fill out the registration form and download the article online. The Review Panel can fill out the evaluation form online. This platform is design as a platform in article management developed online and interactively.

The online platform can assist in the efficient and systematic management of articles between the author and the review panel. The objectives of innovations is to improve lecturers' skills in research, writing and publishing. It also to provide opportunities and space for lecturers to share experiences, ideas and results of writing and innovation with other participants. This platform also improving the quality of research and scholarly writing in line with current developments at the polytechnic.

From this innovation, the evaluation process of an article can be viewed online in a web platform. Lecturers and evaluators can follow the article management and publication process at any time. The writers themselves can evaluate the quality of their writing by reviewing the article comments filled in by the appointed article reviewer. By making your own assessment and constructive comments from online article reviewers then the quality of this innovation is constantly improved from time to time.

The development of the Digest@JMSK website was created as a platform for researchers who are interested in submitting articles to be published in Digest@JMSK papers. Through this website can indirectly help users to obtain information related to the format of writing, article submission as well as comprehensive information related to article writing. Users can also take advantage of the information available on this website and increase interest in research and further contribute to the development of the country through the results of research conducted. This innovation is expected to be able to speed up and give an understanding to the lecturers of the procedure of writing articles and sending articles to the secretariat of digest@JMSK papers through the website.

In addition, it is hoped to cultivate the interest of lecturers to learn and deepen the techniques of scientific writing interactively. This innovation was developed to encourage lecturers to create scientific writing efficiently and systematically. Lecturers can also repeat several times on the way of scholarly writing according to their ability. Lecturers can also prepare in advance before carrying out scholarly writing by browsing the techniques and

examples of articles available on the site. The My IPO number is **NO.HARTA INTERLEK, LY2020002406** and the serial number of ISSN is **NO ISSN , ISSN 2289-3210** and **eISSN 2756-8997**

Acknowledgement

We are grateful for Politeknik Kota Bharu to concern and encourage through enhance our in sting innovation

References

- Ab Aziz, N., & Hassan, J. (2008). Faktor-faktor Yang Mempengaruhi Minat Terhadap Matematik di Kalangan Pelajar Sekolah Menengah (Doctoral dissertation, Universiti Teknologi Malaysia).
- Aziz, M. A. (2020). Graduan di Malaysia meningkat kepada 5.3 juta orang. Berita Harian. <https://www.bharian.com.my/berita/nasional/2020/08/718587/graduan-di-malaysia-meningkat-kepada-53-juta-orang>
- Jabatan Pengajian Politeknik. (2013). Senarai politeknik KPT. Dicapai pada 20 September 2013 melalui <http://www.politeknik.edu.my/portalbpp/index.asp?pg=poli>
- Kementerian Pendidikan Malaysia. (2019). Laporan Analisis Keputusan Sijil Pelajaran Malaysia (SPM) Tahun 2019. Dicapai melalui http://lp.moe.gov.my/files/spm/2020/Laporan%20Analisis%20Keputusan%20SPM%202019_Upload.pdf Kementerian Pendidikan Malaysia (2020). Garis Panduan Penyelarasan Sijil Dan Transkrip Akademik Politeknik Malaysia Edisi Jun 2020. Sistem Gred (Diploma) (pp.27).
- Mohamad Johdi Salleh, Mazliza Kamin & Jane F.H. (2012). Kajian Terhadap Faktor-faktor Mempengaruhi Pencapaian Pelajar Dalam Penilaian Menengah Rendah di Sabah. Labuan International Conference on Education Research. Dipetik pada Julai, 1, 2016 dari http://irepiumedumy/26876/1/Full_Paper_LICER_Faktor_Pencapaian_Akademik_PMR_di_Sabah.pdf
- Mohd, R., Noor, M., Shamsuddin, N. S., & Awang, S. (2018). Pemahaman Konsep Matematik Terhadap Pelajar Ulang Kursus DBM2013 di Politeknik Sultan Mizan Zainal Abidin, Dungun, Terengganu. Politeknik & Kolej Komuniti Journal of Social Sciences and Humanities, 28-41.

HUMAN INTELLIGENCE PERFORMANCE PREDICTION BASED ON AI METHODS

Raja Suzana Raja Kasim

Faculty of Entrepreneurship and Business, Universiti Malaysia Kelantan, City Campus,
Pengkalan Chepa, 16100 Kota Bharu, Kelantan
rajasuzana@umk.edu.my

Ghous Bakhsh Narejo², Zulazli Hashim³, Nurul Afiqah Zulazli⁴, Wan Nor Munirah Ariffin⁵

²NED University of Engineering & Technology, Karachi, Pakistan

^{3,4}Universiti Malaysia Kelantan, City Campus, Pengkalan Chepa, 16100 Kota Bharu, Kelantan, Malaysia

⁵Universiti Malaysia Perlis, Perlis Malaysia

²ghousnarejo12@gmail.com; ³zulazli.hashim@gmail.com; ⁴fiqazalee@gmail.com; ⁵munirah@unimap.edu.my

Highlights: A human intelligence performance prediction for analysing the social profile data of the individual performance is obtained through application of data analytics and artificial intelligence. The user data belonging to a target group of individuals in an office, organisation, industry or community whose daily work related activities data is obtained and processed further employing AI based data analytics algorithm to generate the set of quantitative data reports about the individual and collective data profile based upon their actions and speech. The collected consumer data is given to data analytics and AI algorithms to generate the second set of classified data, cleaned and processed for the classification and detection of the meaningful results to predict social profile of workforce intelligence.

Key words: *human intelligence, artificial intelligence, industry 4.0, technopreneurship, Malaysia.*

Introduction

The primary object of this human intelligence performance prediction (HIPP) invention is to provide an algorithm that acquires the sensory data in real-time from the field containing the performance of human intelligence of the individual who work within the office, organisation, industry or community whose daily work related activities data is obtained and processed all data in real-time.

The data is taken through mobile sensors, field cameras and shared wirelessly using the cloud computing, WSN and IOT to fetch the data to a central location where human intelligence performance prediction algorithm, already trained, is tested. The algorithm detects an act of human intelligence of the individual who work within the office organisation, industry or community whose daily work related activities data is obtained and processed and reports real time.

Description of the Innovation

HIPPs uses LSTM algorithm [please see Figure 1 on generic algorithm structure] by acquiring the data in real time through the sensors located in the physical environment. The sensor data is then sent to a processor wirelessly. The algorithm extracts the features of interest such as physical acts of piety based upon the earlier data base after training on these actions [please see Figure 2 on novel LSTM feature extraction and detection algorithm].

The test phase starts, where the physical sensory data is tested and the decision is automatically conveyed about each individual about his/her acts and its association with socio economic significance in the individual/community report.



Figure 1: A generic algorithm structure



Figure 2: A novel LSTM feature extraction and detection algorithm

Advantages of the Innovation

A program code easy to be operated by the individual who work within the office, organisation, industry or community collectively, with ease of operations to acquire the raw data set and process automatically as the processed data set, readily available as the useful advice in real-time for the community and the individual on the multiple screens. Figure 3 shows the data flow using AI Algorithm to detect human intelligence performance which consists of the set of data denominated here as the first data set for the target group of individual consumers.



Figure 3: Data flow using AI Algorithm to detect human intelligence performance data

Novelty

The novelty of HIPP is on its ability to measure the anomalies in social behavioural datas well as forecasting immediately to give value for predicting performance in the aspect of socio economic impact of enterprise. • The innovation offers on the IOT, ML, Data mining and big data analytics with primary uses: predicting performance for the socio economic output of the social enterprises related with their financial datas. • The AI system automates the data, processing, and decisions made for the welfare of enterprises on the projects where government agencies and the NGOs wish to assess the output of their investment. Greenpreneur learners and educators build a solid foundation in critical 21st-century skills and Industrial Revolution 4.0. The innovation fits the enterprises' startup and Green SME promotion agenda in Malaysia

Benefits to other industries

The profile of the individual, the group and the community is developed in that particular setting recording the consumer behaviour in terms of the human intelligence performance and the data obtained is employed for the forecast of the individual needs, preferences, including the priority in the acts of human intelligence of the individual who work within the office, organisation, industry or community whose daily work related activities data is obtained and processed.

The set of raw as well as processed data is employed for training and testing the AI algorithm to generate a predictive model on the individual human intelligence profile in the complex contest of the predicting performance success. The daily work related activities and the predictive model is coupled to generate the advance metrics covering the futuristic performance of the individual who work within the office, organisation, industry or community

Commercialisation values

The commercialisation values offer a return on investment in support of green technologies in Industry 4.0 to B2B, B2G and B2C. Ministry of Entrepreneur and Cooperative Development benefits in preparing market in particular micro SME enterprises to meet their financial reporting challenges. Ministry of Education Malaysia will benefit sufficient number of qualified trainers in meeting the industry 4.0 talent to grow. Ministry of Women and Family Development may main-streaming women (gender) participation in support of growing new entrepreneurs. UA/schools/audit centers will prepare human capital, workforce, future social entrepreneurs, students, graduates with the automatic analysis of financial statement with creativity, innovative and problem-solving skills to meet the science and green technology challenges.

Business Model

1. B2B (Industry) and B2C (consumer)
 - Consulting solutions pay per professional services (depends on large datasets)
 - Feature such as designed and collect consumer data
 - generate first & second set of data
 - generate classification & detection and processed by AI Algorithm
2. B2G (education)
 - Pay per use - digitally delivered with Access Code and innovative curriculum to make users smart in AI for all.

References

- Aspiranti, T., Amaliah, I., Mafruhah, A.Y., Kasim, R.S.R (2020), Dynamic behaviour model. Polish Journal of Management Studies. DOI: 10.17512/pjms.2020.22.1.04
- Hanieh Alipour Bazkiaei, Low Hock Heng , Noor Ullah Khan , Roselina Binti Ahmad Saufi & Raja Suzana Raja Kasim (2020). Do entrepreneurial education and big-five personality traits predict entrepreneurial intention among universities students? Manuscript DOI: 10.1080/23311975.2020.1801217 (IF: 0.860), Journal: Cogent Business & Management
- Raja Suzana Raja Kasim, Fakhar Shahzad and Wan Suzanna Aafanii Adeeba Binti Wan Ibrahim (2020) COVID-19 Impact on Business Sustainability: A Case of Micro-Small and Medium Enterprises in Malaysia. Horizon J. Hum. & Soc. Sci. 2 (S): xx – xx, <https://horizon.jhssr.com/current-issue.php> (2020)
- Raja Suzana Raja Kasim, Fakhar Shahzad (2020). Unveiling the adverse effect of late-night use of social media on female' entrepreneurial cognitive engagement: a stressor-strain-outcome perspective (IJEER-04-2020-0256). <https://www.frontiersin.org/Frontier in Psychology> (Scopus)
- Raja Suzana Raja Kasim, Zulazli Hashim, & Zainudin Awang (2017). Social innovation and its influence on youth startup: the marginalised communities in Malaysia. PERTANIKA Journal of Social Science & Humanities (JSSH), 25(S), 89-98.
- Raja Suzana Raja Kasim, Zainudin, Awang, & Zulazli Hashim (2017). Keusahawanan dan inovasi sosial: ke arah penjanaaan semula pembangunan generasi muda yang positif. In Raja Suzana R.K., & Samsudin, A.R., (Ed.), Generasi muda komuniti terpinggir: kearah penjanaaan semula pembangunan generasi muda. (Pp. 87-121). Kota Bharu, Kelantan: Penerbit Universiti Malaysia Kelantan
- Raja Suzana Raja Kasim, & Zulazli Hashim (2018). Pemerksaan keusahawanan generasi muda komuniti terpinggir lulusan TVET dalam menangani cabaran arus industri 4.0 ke arah negara maju. In Raja Suzana R.K., & Samsudin, A.R., (Ed.), Generasi muda komuniti terpinggir: kearah penjanaaan semula pembangunan generasi muda. (Pp. 145-169). Kota Bharu, Kelantan: Penerbit Universiti Malaysia Kelantan.
- Yudha Dwi Nugraha, Raja Suzana Binti Raja Kasim, Tasya Aspiranti, Nunung Nurhayati, and Ima Amaliah, (2020)., How does the government boost the entrepreneurship community in Entrepreneurial Ecosystem in Higher Education. India, Lucknow: Empryal Publishing House, p. 8-22.

ARTIFICIAL INTELLIGENCE SYSTEM AND METHOD FOR SUSTAINABLE SOCIAL FINANCE DATA PREDICTION

Raja Suzana Raja Kasim

Faculty of Entrepreneurship and Business, Universiti Malaysia Kelantan, City Campus,
 Pengkalan Chepa, 16100 Kota Bharu, Kelantan
 rajasuzana@umk.edu.my

Ghous Bakhsh Narejo¹, Zulazli Hashim², Nurul Afiah Zulazli², Wan Nor Munirah Ariffin³

¹ NED University of Engineering & Technology, Karachi, Pakistan

²Universiti Malaysia Kelantan, City Campus, Pengkalan Chepa, 16100 Kota Bharu, Kelantan, Malaysia

³Universiti Malaysia Perlis, Perlis Malaysia

ghousnarejo12@gmail.com 3zulazli.hashim@gmail.com 4fiqazalee@gmail.com 5munirah@unimap.edu.my

Highlights: The AI with machine learning (ML) and LSTM algorithms are employed to minimise the existing paper work as well as the reading and processing financial data that processes the documents and the financial data as well as take the financial decisions critical to social organisations. Modeling Artificial Intelligence methods (AIMS) is a copyrighted and patented ML which consists of forecasting the financial standing such as balance sheet, statements of changes in owner's equity, income and cash flow statements and extract value from this activity. AIMS can forecast social enterprises sustainable funding, budget and several other socio and economics' indicators, thus help the entity improves its performance.

Key words: *sustainability, social finance, data analytics, artificial intelligence, industry 4.0, technopreneurship, Malaysia.*

Introduction

The statistics and historical data of thousands over social enterprises that exist in the Malaysian setting will be captured, documented, and analyzed using artificial intelligence data analytics. Key pain points to be addressed will be on examining information overload and fragmented data. The focus on transacting daily operation in manual format have triggered numbers of weaknesses in managing the data diligently and accurately. Timeliness, speed and accuracy in reporting mechanism is becoming vital as it requires effectiveness in managing this information. The extent of breadth and depth of the analysis is to address the commercial and social cause performance of the social enterprises. The AI with machine learning (ML) algorithms is employed to minimise the existing paper work, the reading and processing financial data and take the financial decisions. AI employs four steps of data collection, data engineering, algorithm development, and algorithm refinement to impact social Enterprises. AI accelerates the transition from a linearly designed economy to a circularly growing economy.

Description of the Innovation

We develop the sensory data base consisting of the social as well as financial datasets of the individuals in a community. The LSTM algorithm is trained on the data set belonging to the individuals in a community. After the successful training of the algorithm on the data set, the LSTM is provided with the testing data sets concerning the social and financial activities of each individual in the community.

On the test data set, the algorithm detects the anomalies and forecasts the financial state of the transactions as well as looks into financial market activities of the individuals related to demand, supply, inventory, price, and general market indicators. Modeling AIMS is a copyrighted and patented ML which consists of forecasting the financial standing such as balance sheet, statements of changes in owner's equity, income and cash flow statements and extract value from this activity. The AIMS also makes use of algorithms such as Quantile Regression Forest, Support Vector Regression, recurrent neural network, linear regression, logistic regression, clustering, random forest. AIMS analyzes historical data to understand the demand, supply, and inventory, then forecasts the future's demand, supply, and inventory. AIMS can forecast social enterprises sustainable funding, budget and several other socio and economics' indicators, thus help the entity improves its performance.

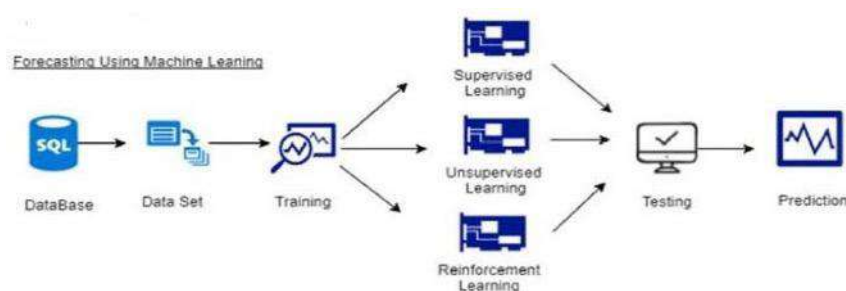

Figure 1: A generic AI algorithm

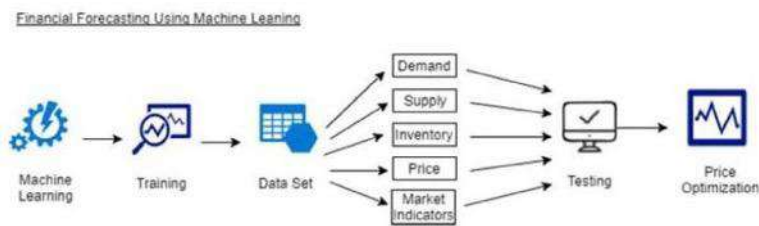

Figure 2: A novel LSTM algorithm for financial prediction

Advantages of the Innovation

A program code easy to be operated by the individual consumer and the community collectively, with ease of operations to acquire the raw data set and process automatically as the processed data set, readily available as the useful financial advice in real-time for the community and the individual on the multiple screens. Figure 3 shows the data flow using AI Algorithm to detect social finance consumer data which consists of the set of data denominated here as the first data set for the target group of individual consumers.

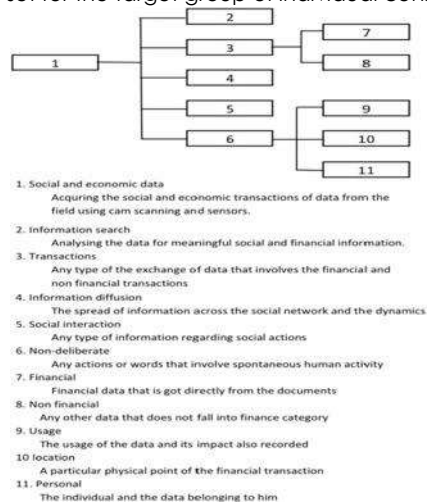

Figure 3: Data flow using AI Algorithm to detect social finance data

Novelty

- The novelty of HIPP is on its ability to measure the anomalies in social behavioural datas well as forecasting.
- AIMS offers a set of social profile of the enterprise, the group and the community is developed in that particular setting recording the social finance behaviour.
- The innovation is a solution provider and robovisor in terms of the social finance data, sales, demand, purchase and the data obtained is employed for the forecast of the enterprise' needs, preferences, including the priority in the social finance data, sales, demand, purchase, and other financial activities for the enterprise as well as the group. immediately to give value for predicting performance in the aspect of socio economic impact of enterprise.
- The innovation offers on the IOT, ML, Data mining and big data analytics with primary uses: predicting performance for the socio economic output of the social enterprises related with their financial datas.
- The AI system automates the data, processing, and decisions made for the welfare of enterprises on the projects where government agencies and the NGOs wish to assess the output of their investment.
- Greenpreneur learners and educators build a solid foundation in critical 21st-century skills and Industrial Revolution 4.0
- The innovation fits the enterprises' startup and Green SME promotion agenda in Malaysia

Benefits to other industries

The profile of the individual, the group and the community is developed in that particular setting recording The enterprises' and social enterprises' behaviour in terms of the social finance performance. The data obtained is employed for the forecast of the social finance needs in particular setting recording the social finance behaviour in terms of the

- social finance data, sales, demand, and purchase and

- the data obtained is employed for the forecast of the enterprise' needs, preferences, including the priority in the social finance data, sales, demand, purchase, and other financial activities for the enterprise as well as the group

The set of raw as well as processed data is employed for training and testing the AI algorithm to generate a predictive model on the enterprise social finance profile in the complex contest of the predicting sustainable social finance opportunities.

The sustainable social finance footprints and the predictive model is coupled to generate the advance metrics covering the futuristic behaviour and trend of sustainable social finance for the enterprise, the group and the community.

Commercialisation values

- The commercialisation values offer a return on investment in support of green technologies in Industry 4.0 to B2B, B2G and B2C.
- Ministry of Entrepreneur and Cooperative Development: preparing market in particular micro SME enterprises to meet their financial reporting challenges.
- Ministry of Education: Malaysia will benefit sufficient number of qualified trainers in meeting the industry 4.0 talent to grow.
- Ministry of Women & Family Development: mainstreaming women (gender) participation in support of growing new entrepreneur
- UA/schools/audit centers: prepare human capital, workforce, future social entrepreneurs, students, graduates with the automatic analysis of financial statement with creativity, innovative and problem-solving skills to meet the science and green technology challenges.

Business Model

1. B2B (Industry) and B2C (consumer)

- Consulting solutions pay per professional services (depends on large datasets)
- Feature such as designed and collect consumer data
- generate first & second set of data
- generate classification & detection and processed by AI Algorithm

2. B2G (education)

Pay per use - digitally delivered with Access Code and innovative curriculum to make users smart in AI for all

Acknowledgement

This research was supported by the Fundamental Research Grant Scheme [R/FRGS/A0100/01530A/002/2020/00890]; Ministry of Higher Education Malaysia.

References

- Aspiranti, T., Amaliah, I., Mafruhat, A.Y., Kasim, R.S.R (2020), Dynamic behaviour model. Polish Journal of Management Studies. DOI: 10.17512/pjms.2020.22.1.04
- Yudha Dwi Nugraha, Raja Suzana Binti Raja Kasim, Tasya Aspiranti, Nunung Nurhayati, and Ima Amaliah, (2020)., How does the government boost the entrepreneurship community in Entrepreneurial Ecosystem in Higher Education. India, Lucknow: Emypreal Publishing House, p. 8-22.
- Hanieh Alipour Bazkiaei , Low Hock Heng , Noor Ullah Khan , Roselina Binti Ahmad Saufi & Raja Suzana Raja Kasim (2020). Do entrepreneurial education and big-five personality traits predict entrepreneurial intention among universities students? Manuscript DOI: 10.1080/23311975.2020.1801217 (IF: 0.860), Journal: Cogent Business & Management
- Raja Suzana Raja Kasim, Fakhra Shahzad and Wan Suzanna Aafanii Adeeba Binti Wan Ibrahim (2020) COVID-19 Impact on Business Sustainability: A Case of Micro-Small and Medium Enterprises in Malaysia. Horizon J. Hum. & Soc. Sci. 2 (S): xx – xx, <https://horizon-jhsr.com/current-issue.php> (2020)
- Raja Suzana Raja Kasim, Fakhra Shahzad (2020). Unveiling the adverse effect of late-night use of social media on female' entrepreneurial cognitive engagement: a stressor-strain-outcome perspective (IJEER-04-2020-0256). <https://www.frontiersin.org/Frontier in Psychology> (Scopus)
- Raja Suzana Raja Kasim, Zulazli Hashim, & Zainudin Awang (2017). Social innovation and its influence on youth startup: the marginalised communities in malaysia. PERTANIKA Journal Of Social Science & Humanities (JSSH), 25(S), 89-98.
- Raja Suzana Raja Kasim, Zainudin, Awang, & Zulazli Hashim (2017). Keusahawanan dan inovasi sosial: ke arah penjanaaan semula pembangunan generasi muda yang positif. In Raja Suzana R.K., & Samsudin, A.R., (Ed.), Generasi muda komuniti terpinggir: kearah penjanaaan semula pembangunan generasi muda. (Pp. 87-121). Kota Bharu, Kelantan: Penerbit Universiti Malaysia Kelantan
- Raja Suzana Raja Kasim, & Zulazli Hashim (2018). Pemerkaasaan keusahawanan generasi muda komuniti terpinggir lulusan TVET dalam menangani cabaran arus industri 4.0 ke arah negara maju. In Raja Suzana R.K., & Samsudin, A.R., (Ed.), Generasi muda komuniti terpinggir: kearah penjanaaan semula pembangunan generasi muda. (Pp. 145-169). Kota Bharu, Kelantan: Penerbit Universiti Malaysia Kelantan.

COMPACT RECIRCULATING AQUACULTURE SYSTEM (CORALS): ASIAN CLAM SAVIOUR

Zharif Ramli

Faculty Agro-Based Industry, Universiti Malaysia Kelantan,
zhariframli@yahoo.com

Aweng Eh Rak¹, Lee Seong Wei²

¹Faculty Agro-Based Industry, Universiti Malaysia Kelantan,

²Faculty of Earth Science, Universiti Malaysia Kelantan,
aweng@umk.edu.my, leeseong@umk.edu.my

Highlights: Compact Recirculating Aquaculture System (CORALS) is a novel system developed for Asian clam, *Corbicula fluminea* (etok) juveniles. The CORALS comprises four components and it is divided into filtration and rearing components. The filtration components comprise the biological, mechanical, and chemical components. Four rearing chambers, each of which can accommodate 2000 juveniles/chamber. Newly metamorphosed juveniles are held in this system. The CORALS is reasonable and simple in structure, lower in cost, replicable, and the purpose of rearing the freshwater bivalve in the hatchery is achieved.

Key words: *etok, Corbicula fluminea, juveniles, RAS, CORALS, hatchery*

Introduction

Aquaculturists are concerned about a freshwater clam from the genus *Corbicula* because of its potential for food production. Furthermore, the *Corbicula* has become very valuable as a food source, particularly in Asia. They were heavily harvested from the natural habitat which endangerment their population including in Malaysia. Predominantly, the *C. fluminea* inhabited our freshwater bodies and well known as etok in a local name (Ramli et al., 2020). Fortunately, *Corbicula* has a unique life cycle that necessitates the reproduction by an individual which could be maintaining their existence for a certain time.

Attempts to reproduce and culture *Corbicula* have been made in the past. However, since the *Corbicula* is considered an invasive species in western countries, their research is mainly for ecological purposes (King et al., 1986). Furthermore, the *C. fluminea* was cultured and reared in Taiwan in a flow-through raceways system, which requires a huge water amount in comparison to the biomass of the juveniles. Because of the juvenile's clam's small size, a properly built recirculating aquaculture system (RAS) will keep thousands of individuals alive in just a few litres of water. The small size of juvenile clams presents difficulties in handling and confining them in flowing water. The released juveniles of *C. fluminea* generally range between 170 and 250 µm in length. These juveniles are easily suspended by currents, such that they can be lost from the open containers in flowing water. Furthermore, the juveniles crawl and drift which not surprising, the loss in grow-out, relocation, and death (Sicuro, 2015). Many marine species are successfully grown and survive well in the closed RAS which extensively uses for rearing adults and juveniles (Huang et al., 2013). The uses of RAS were reported in culturing freshwater juvenile mussels such as *Chamberlainia hainesiana* (Kovitvadi & Kovitvadi, 2013), *Hamiota altilis* (Fobian et al., 2017), *Unionidae* (Barnhart, 2005) which probably can be applied to culture the *C. fluminea* juveniles.

Since the *C. fluminea* juveniles are small enough to occupy the diffusive boundary layer, maintaining enough flow in culture systems is critical. The diffusive boundary layer is a benthic zone closely adjacent to surfaces, where friction reduces water movement to the point that diffusion, rather than convection, becomes the dominant mode of solute transport. The system should be constructed to alleviate stagnant zones while maintaining consistent flow and water quality. The functions of compartments in this recirculating system were defined in this paper. The *C. fluminea* juveniles were reared for 90 d and the growth and survival rates were evaluated.

Content

Compared to other freshwater bivalves, the *C. fluminea* is uncommon to be produced and farmed. Practice in Kelantan, the harvested *C. fluminea* was placed in a basket for a few days in the river before further use. However, the fluctuation of water current and quality parameters were distressing the live *C. fluminea* and causing a death. Recently, recirculating aquaculture systems (RAS) received great attention in aquaculture. Still, little information on the RAS for rearing freshwater bivalves, their enhancement is required. Therefore, a compact recirculating aquaculture system (CORALS) that accommodates the *Corbicula* juveniles is needed to be specific to grow the juveniles and enhance survivability.

The CORALS (Fig. 1) has three filtration compartments namely biological (1), physical (3), and chemical (4). First, biological filtration comprises Bio-balls. Then, water inflow at this compartment and flow to the rearing chambers (2). The water flows through the cups and flows into physical filtration (corals and crushed shells). Finally, the water reaches chemical filtration (activated carbon) and a small submersible aquarium pump circulated water from this chamber to the biological chamber. The nominal flow rate for this model pump is 400 Lh⁻¹.

In the rearing compartment (2), four rearing chambers for confining juveniles were installed made up of polyvinyl chloride (PVC) cone-shaped cups (diameter of top: 6.0 cm and bottom: 3.0 cm). A nylon screen (mesh 200 µm) was placed at the bottom of the pipe. Then, the nylon screen was glued at the top of the coupling, forming a filter cup. Pairs of filter cups were press-fit loosely together to form chambers that can accommodate the juveniles. These

chambers could be opened by separating the two filter cups, allowing access to the juveniles. Each chamber was positioned vertically in the recirculating system so that the juveniles rested on the screen of the lower cup. The CORALS is replicable and can be amplified to increase the seeds production in the future.

This invention had established a culturing technique of the *C.fluminea* juveniles in the RAS. Then, this invention has successfully grown and enhances the survival of *C.fluminea* juveniles in a captive system. This novel rearing system enables the *C.fluminea* juveniles to sustainably be reared and may generate another source for economic purposes. In summary, this work possibly proposes that *C.fluminea* be farmed due to it feasible as valuable aquaculture species, particularly in this region.

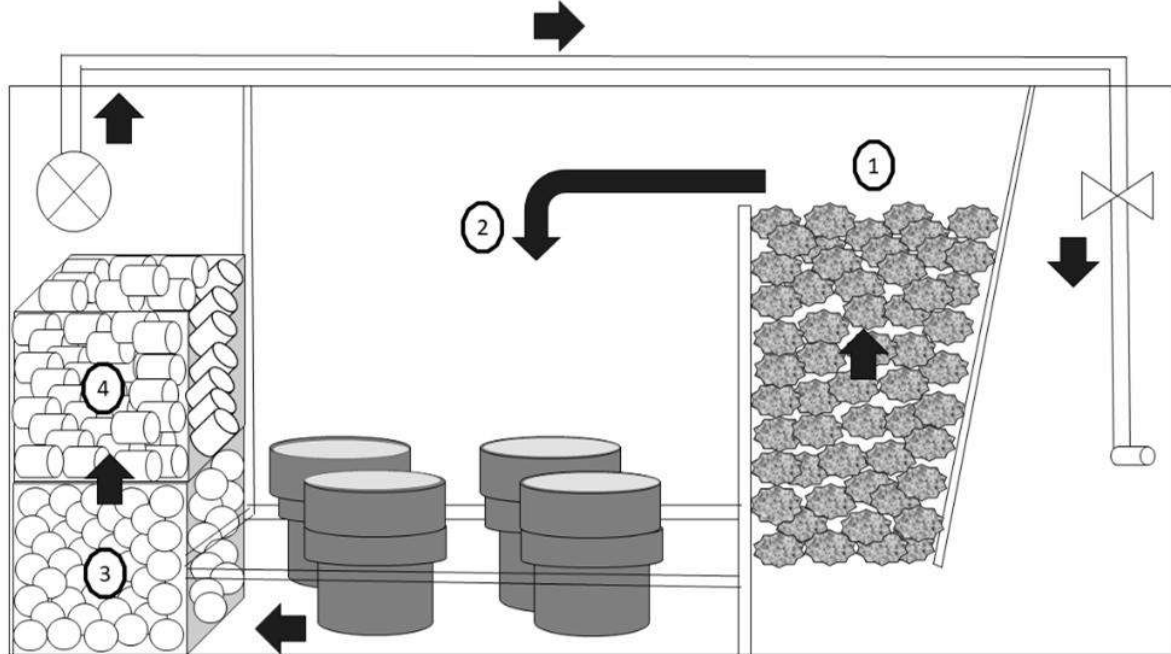

Figure 1: Schematic diagram of CORALS and the water flow direction (arrow).

Acknowledgement

This study was supported by the Malaysia Ministry of Education under the Transdisciplinary Research Grant Scheme (TRGS) R/TRGS/A0.700/00387A/007/2016/000391.

References

- King, C. A., Langdon, C. J. & Counts, C. L. (1986). Spawning and early development of *Corbicula fluminea* (Bivalvia: Corbiculidae) in laboratory culture. *American Malacological Bulletin* 4: 81-88
- Kovitvadi, S., & Kovitvadi, U. (2013). Effects of rearing density and sub-sand filters on growth performance of juvenile freshwater mussels (*Chamberlainia hainesiana*) reared under recirculating system conditions. *Science Asia*, 39, 139-149.
- Fobian, T. B., Buntin, M. L., & Johnson, P. D. (2017). Juvenile Freshwater Mollusk Culture System Designs from Metamorphosis to Release. Barnhart, M. C. (2006). Buckets of muckets: A compact system for rearing juvenile freshwater mussels. *Aquaculture*, 254:227-233.
- Huang, Z., Jones, J., Gu, J., Hallerman, E., Lane, T., Song, X., & Wan, R. (2013). Performance of a recirculating aquaculture system utilizing an algal turf scrubber for scaled-Up captive rearing of freshwater mussels (Bivalvia: Unionidae). *North American Journal of Aquaculture*, 75(4), 543-547.
- Ramli, M. Z., Ayyapan, V., Yusoff, A., Eh Rak, A., & Lee, S. W. (2020). Phenotype and Genotype Characterisation of the Asian Clam of the Genus *Corbicula* Megerle von Mühlfeld, 1811 (Venerida, Cyrenidae) from the East Coast of Peninsular Malaysia. *Borneo Journal of Resource Science and Technology*, 10, 24-36.
- Sicuro, B. (2015). Freshwater bivalves rearing: a brief overview. *International Aquatic Research*, 7(2), 93-100. <http://doi.org/10.1007/s40071-015-0098-6>

RIZBRUNANA: ADVANCES IN HIGH-FIBRE BISCUIT USING BROWN RICE AND BANANA PEEL

Nurul Hafizah Mohd Yasin

Faculty of Hospitality, Tourism and Wellness, Universiti Malaysia Kelantan, Malaysia
hafizah.my@umk.edu.my

Derweanna Bah Simpong, Nur Farihin Abd Hadi Khan, Mazne Ibrahim

Faculty of Hospitality, Tourism and Wellness, Universiti Malaysia Kelantan, Malaysia
derweanna@umk.edu.my, farihin.ah@umk.edu.my, mazne@umk.edu.my

Highlights: Malaysian adults consumed less than the recommended dietary fiber intake of 20-30 g/day. Therefore, study was conducted to develop a product of high-fiber brown rice biscuits made from Saba' banana peel flour. This high fiber biscuit contained 463.40g/100 of energy, 9.23g/100 of protein, 18.98g/100 of fat, 60.16g/100 of carbohydrate, and 7.53g/100 of dietary fiber. The consumer test shows good potential of commercialization as 77% of respondents like and would buy this biscuit.

Keywords: High-fibre biscuit, brown rice, banana peel, commercialization, product development.

Introduction

The food industry is now primarily concerned with functional food ingredients that are high in fiber. In this light, the development of this product is sparked by the awareness on the importance and benefits of dietary fiber contents of food products available in the current market. Dietary fibers have been shown to have many health benefits. For instance, it can improve the function of the digestive system and are able to reduce the risk of many chronic diseases such as cancer, diabetes and heart disease (Cui & Robert, 2009). According to the American Dietetic Association (ADA), the proposed dietary fiber intake for adults is 20g to 35g/1000 Kcal for Americans. Meanwhile, the recommendations for fiber intakes among Malaysians are 20g to 30g per day for all ages. However, 77% of these populations failed to achieve the recommended average intake; Americans were found to take about 14g to 15g dietary fiber per day, while Malaysians consumed 13g to 16g per day. These figures are lower than the proposed recommendations (Ng et al., 2010).

Rice is an example of high-fiber cereals. There are more than 40,000 varieties of rice grown around the world. Rice is the staple food in Malaysia and white rice is commonly consumed. On the other hand, brown rice is rarely consumed because of its dreadful tastes and takes longer time to cook compared to white rice. However, brown rice has gained its popularity in recent years due to its health benefits, brown rice is recognized for its food value content and its potential as a source of antioxidants, anti-carcinogenic and others (Paretti et al., 2002).

Bananas are one of the foods with high fiber contents. They also have high nutritional values. Banana is easily reproduced at an optimal temperature of 27°C, easily grown and available in tropical Malaysia and could be bought at low prices. However, the high consumption of bananas also caused an increase by product of banana peel wastes. High amount of waste has been giving problems to the disposal system of this material without affecting the environment (Emaga et al., 2008). There are various studies conducted regarding the use of other waste products that has been utilized into marketable products, and reported that most of these waste materials contain greater nutritional value than its fruits and vegetables. A study by Emaga et al. (2008), found that 50% of the fibre in bananas are contained in the banana peel. Production of flour from banana peel is able to address the issues of minimizing food waste disposal and maximizing the use of natural resources. Therefore, this issue also provides an opportunity for researchers to develop a product that could solve this problem.

Methodology

The main raw materials in the production of the high-fiber biscuits are brown rice and banana peels. The details about the processing of biscuits are discussed as follows.

Processing of High-Fiber Brown Rice Biscuit and Banana Peel Flour Mixes

To ensure the quality of biscuits produced, brown rice flour and banana peel flour were sifted to remove the impurities. Each ingredient including the brown sugar, baking powder and butter, was weighed respectively. Then, the brown sugar, baking powder, egg yolks and butter were put into the mixer and mixed thoroughly until they become smooth. Brown rice flour and banana peel flour were added into the dough. The dough was refrigerated for 20 minutes, then, it was shaped and divided into portions weighting 10.0 ± 0.5 g for each dough. The dough were then baked in the oven with a temperature of $170 \pm 5^\circ\text{C}$ for 20 minutes. The cooled biscuits were wrapped with plastic polypropylene (PP).

The basic formulation was modified from flour, brown sugar, butter and made into 8 new formulations using experimental design factorial 4×2 where 4 levels of the ratio of brown rice flour and banana peel flour and 2 levels of the ratio of brown sugar and butter. Based on the basic formulation by Nagao (2001), the ratio of butter and brown sugar is 2:2. The formulation developed in the initial test was changed based on the results obtained in all three best formulations with the butter and brown sugar ratio of 3:2. Thus, the ratio of butter and brown sugar formulations developed for the next test using the formulations with the butter and brown sugar ratio of 3:2 and 2:3

to test the formulation that will be most accepted by the expert panel. These formulations were modified to obtain the taste and texture to suit the developed product.

Findings

Sensory Evaluation

Sensory evaluation tests were carried out on eight biscuit formulations, which were divided into three sessions. Each session consists of four sample formulations. The data obtained from test using BIB designs were analyzed using Friedman test to get the T value on the degree of accuracy and the level of differences of 5% to determine significant differences between the data obtained. It was found that there was no significant difference ($p > 0.05$) between F6 samples and other samples. Three samples which had the lowest amount of the composition, as well as showing a significant degree of difference are sample 6, 8 and 4. These samples were selected to undergo Hedonic Test. Sample 6 was the sample that has the lowest score among respondents; this sample had the second largest banana peel content, which is 13.5% while the ratio of butter and brown sugar content was 2:3. In conclusion, majority of the respondents favoured the formulation containing a moderate amount of banana peel flour (7:3), and followed by formulation with the highest ratio of banana peel content (6:4).

Hedonic Test

Three best formulations of sample F4, F6 and F8 were selected to undergo Hedonic Test. Table 1 shows the results obtained from one-way ANOVA analysis for the Hedonic Test. Based on the results of sensory evaluation, the F6 formulation is the most accepted formulation by the panellists in all attributes tested and there were significant differences ($p < 0.05$) exists in every attribute tested. This means that there are significances in each attribute.

Nutrition Information

The energy content of the biscuits obtained is shown in Table 1 below.

Table 1: Nutrition information

Nutrition	100g	Serving size (10g)
Energy (kcal)	463.40	46.34
Protein (g)	9.23	0.92
Fat (g)	18.98	1.90
Carbohydrate (g)	60.16	6.02
Dietary Fiber (g)	7.53	0.75

Storage Quality Study

The storage quality study for high-fiber brown rice with banana peel flour biscuits was carried out for 8 weeks. Throughout this study, these biscuits were packed in polipropena plastic (PP) and stored at room temperature. In this study, physicochemical analysis, microbiological test and sensory evaluation tests were conducted on the biscuits during storage period.

Product Novelty and contribution to education/community

Dietary fiber have been studied in the prevention of cardiovascular and colon diseases, and diabetes; these consist about 50% of the dry matter of banana peel. Thus, there is a huge potential in the valorization of this food waste into value-added food products.

Transforming banana peels to powder extends its shelf-life, eases transportation and storage, and broadens its possible food applications.

A waste material such as banana peel can be transformed to a tasty and value-added product of high-fiber biscuit.

Commercial Value

This high-fiber biscuits has good commercial value as 77% of respondents said they would buy these biscuits.

Rizbrunana biscuits are a great start in exploiting the potential of this waste; other products such as cakes, breads can also be explored as food applications.

References

- Cui, S. W. & Roberts, K. T. (2009). Dietary Fiber: Fulfilling the Promise of Added-Value Formulations. Canada: Elsevier Inc.
- Emaga, T. H., Robert, C. H., Se'bastien, A., Ronkar, A., Wathélet, B., & Michel, P. (2008). Dietary fibre components and pectin chemical features of peels during ripening in banana and plantain varieties. *Bioresource Technology*, 99: 4346–4354.
- Nagao, S. (2001). Japanese Snack Foods. *Snack Food Processing*. United State: CRC Press.
- Ng, T. K. W., Chow, S. S. F., Chan, L. P. Y., Lee, C. Y. M., & Lim, S. Q. (2010). Recommended nutrient intake for dietary fibre: bar set too high for Malaysians?. *Malaysian journal of nutrition*, 16(2): 271-280.
- Nielsen, S. S. (2003). *Food Analysis*. 3rd Edition. United States of America: Kluwer Academic.
- Perretti, G., Miniati, E., Montanari, L. & Fantozzi, P. (2002). Improving the value of rice by-products by SFE. *Journal of Supercritical Fluid*, 26: 63–71.

TERMICIDE: ONE DROP SOLUTION TO REPEL HOUSEHOLD PEST TERMITES

Suganthi Appalasamy

Institute of Food Security and Sustainable Agriculture (IFSSA), Universiti Malaysia Kelantan, Jeli, Kelantan, Malaysia
Faculty of Earth Science, Universiti Malaysia Kelantan Jeli Campus, 17600 Jeli, Kelantan, Malaysia
suganthi.a@umk.edu.my

Nivaarani Arumugam¹, Alia Diyana Mohamed Hassim², Boon Jia Geng³, Jayaraj Vijaya Kumaran^{1,4}

¹Faculty of Earth Science, Universiti Malaysia Kelantan Jeli Campus, 17600 Jeli, Kelantan, Malaysia

²Pesticide Action Network Asia Pacific (PANAP), 48, Persiaran Mutiara 1, Pusat Komersial Bandar Mutiara, 14120 Simpang Ampat, Penang, Malaysia

³Faculty of Bioengineering and Technology, Universiti Malaysia Kelantan Jeli Campus, 17600 Jeli, Kelantan, Malaysia

⁴Global Entrepreneurship Research Innovation Centre (GERIC), Universiti Malaysia Kelantan Kota Campus, 16100 Kota Bharu, Kelantan, Malaysia

niva035@gmail.com , aliaamine@gmail.com , jia.geng@umk.edu.my , jayaraj@umk.edu.my

Highlights: Termites caused high economic damages. The currently available pesticide lead to environmental contamination especially at urban areas. A green solution was innovated. Fluid from termites was used as repellent against pest termites. This anti-termite is innovated from termite extract to be used against pest termite. This product has been tested and proven to be effective as anti-termite for pest termites such as *Coptotermes* and *Macrotermes*. A single drop on an affected termite point has been observed to be effective as termiticide and repellent within a week.

Key words: termiticides, pest termites, organic, anti-termite, pest control, Malaysia

Introduction

There are 3106 living and fossil termite species have been recorded in the world (Krishna et al., 2013). Among the recorded species only 10% classified as pest termite species (Lewis, 1997; Grace, 2011). However, the damages caused by the termites are serious. Termites recorded to damage buildings, furniture, crops and more. Various methods have been used to control the pest termites such as chemical products and baiting systems.

Background of Innovation

TERMICIDE is a liquid anti-termite which was developed using mainly compounds isolated from natural extract of termite. This liquid anti-termite functions as repellent for pest termite. The formulated liquid repellent is an outcome from laboratory and intensive field testing. This novel termiticide works against pest termites by sensory repelling signal has been tested and proven to be effective as anti-termite for pest termites such as *Coptotermes* and *Macrotermes*

Description of Innovation

An organic liquid termiticidal developed to control pest termites especially in urban households. This liquid anti-termite functions as repellent for pest termite. With input from local industry (Zabidi Global Ventures) majoring in pesticide development, application of single termiticide drop at affected termite point on wood or termite tunnel has been proven to effective during field survey and able to repel the termites within a week.

Advantage of Innovation

This termiticide product is practically very easy to use with just a single application on the termite infested structures/points at homes. The product does not emit smell or odour that are hazardous to human. The easy application and nontoxic nature of the product ensures the ease of use by all household members. In a nutshell, the design of the product developed in such way to simplify the repelling and also to protect the wooden structures of a urban house from pest termites.

Commercial Value of Innovation

Compared to the current commercially available pesticide which contain toxic compounds and hazardous solvents, this termiticide liquid is developed using Green Chemistry which is nature friendly and non-toxic to environment. A single application has been observed to repel the termites within a week.

Acknowledgement

The authors would like to thank Ministry of Higher Education Malaysia for providing FRGS grant (R/FRGS/A08.00/01330A/002/2016/000375), Geran Yayasan Tan Sri Fng (R/TSF/A0800/01350A/006/2021/00906) and Universiti Malaysia Kelantan (UMK) for providing required facilities. Authors also extend their appreciations towards Zabidi Global Ventures (ZGV) for the input as field test partnering industry.

References

- Krishna, K., Grimaldi, D.A., Krishna, V., & Engel, M.S. (2013). *Treatise on the Isoptera of the world: 1. Introduction*, **377**. New York: Bulletin of the American Museum of natural history
- Lewis, V. R. (1997). Alternative control strategies for termite. *J. Agric. Entomology*, *14*: 291-307.
- Grace, J. K. (2013). Invasive termites and wood protection. *Proceedings of the American Wood Protection Association*. Honolulu, Hawaii, *109*: 42-51.

SPATIAL PREDICTION FOR AMBIENT PARTICULATE POLLUTION USING SPATAP MODEL

Siti Hajar Ya'acob

¹Sustainable Science Program, Faculty of Earth Science, Universiti Malaysia Kelantan Jeli Campus, Kelantan, Malaysia
hajar.y@umk.edu.my

**Siti Aisyah Nawawi¹, Noor Syuhadah Subki¹, Norrimi Rosaida Awang¹, Shaparas Daliman²,
Muhammad Ikram A. Wahab³**

¹Sustainable Science Program, Faculty of Earth Science, Universiti Malaysia Kelantan Jeli Campus, Kelantan, Malaysia

²Natural Science Program, Faculty of Earth Science, Universiti Malaysia Kelantan Jeli Campus, Kelantan, Malaysia

³Center for Toxicology & Health Risk, Faculty of Health Sciences, Universiti Kebangsaan Malaysia, Jln Raja Muda Abd Aziz, 50300 Kuala Lumpur, Malaysia

aisyah.n@umk.edu.my, syuhadah@umk.edu.my, norrimi.a@umk.edu.my, shaparas@umk.edu.my, ikram@umk.edu.my

Highlights: A model was established for PM₁₀ prediction using a spatial approach named as SpatAP model. The SpatAP model is the improved version of the previous spatial model published by Ya'acob & Mar Iman (2020). The model has better specification with four significant predictor variables, namely RH, industry land-use, traffic count, and time for PM₁₀ concentration prediction across Peninsular Malaysia.

Key words: *spatial prediction, GIS, particulate pollutant, land-use.*

Introduction

Ambient particulate concentration occurs to be associated with spatial influences. A variety of spatially related human-made activities cause the distribution of particulate pollutants over the geographic area. Air pollution patterns in Malaysia are yet to be more understood, primarily because vulnerable populations are more likely to live closer to pollutant sources and, most likely, closer to pollutant sensors (Geer, 2014). Concerns have arisen that question the suitability of air pollution status interpreted from stationary monitoring stations as a representative community exposure assessment living at other unsampled locations. Such environmental risk concern is appropriately addressed using advanced geographic information science and spatial modeling, as Jerrett et al. (2010) suggested. Thus, the spatial air pollution (SpatAP) model was established and executed to predict ambient particulate concentration captured by the stationary monitoring stations and other unsampled locations across Peninsular Malaysia.

Content

Tobler's first law of geography reveals that 'everything is related to everything else, but near things are more related than distant things' (Miller, 2004; Tobler, 1970). The law applies to the effective use of the SpatAP model. By incorporating Tobler's law, the SpatAP model expects air pollution levels to not be different between any nearby locality. Firstly, the similarities in the underlying social and economic processes might emit particulate pollution. Secondly, some atmospheric processes will suspend particulate pollutants over large distances and disperse the particulate pollutants from one place to another. Thus, this model's advantages were that it considered the spatial dimension of particulate emission over a 16-years time using land-use types, meteorological parameters, and traffic count as the predictor variables. Figure 1 shows the SpatAP model framework, which consists of parameterization of each predictor variable that spatially represents the 37 air quality monitoring stations. The framework also showed an execution of exploratory regression and Ordinary Least Square (OLS) regression for finding the most suitable predictor variables and final prediction model, respectively. The output from OLS prediction was mapped using kriging interpolation. Based on the significant trend of vehicle population and industrialization area found from the SpatAP model, it was predicted that ambient particulate tends to demonstrate spatial patterns. In other words, the model indicated an important spatial relationship that helps regulatory authority to understand to which extent people's activity's location relates to environmental quality.

Furthermore, the SpatAP model also highlights air quality, particularly the PM₁₀ concentration across a particular geographic locality. Any monitoring activities using the model can give the status of current air quality by geographic sub-region. Subsequently, from this SpatAP model, we can identify the potential accumulation of particulate pollution for a specified duration of exposure to be used as a health risk estimation for the exposed population. We consider this model has innovation value because it added value to the current air monitoring routine by substantially contribute to a better understanding of potential exposure pathways in space overtimes. Also, the model has an added value of the related social distributions of particulate pollutants, leading to a better representative assessment of health effects. Besides, the estimation of particulate concentration caused by land-use types, traffic count, and climatic influences from the SpatAP model is significantly relatable to current rapid urbanization and industrialization happening not only in the Klang Valley region but also in another region of Peninsular Malaysia.

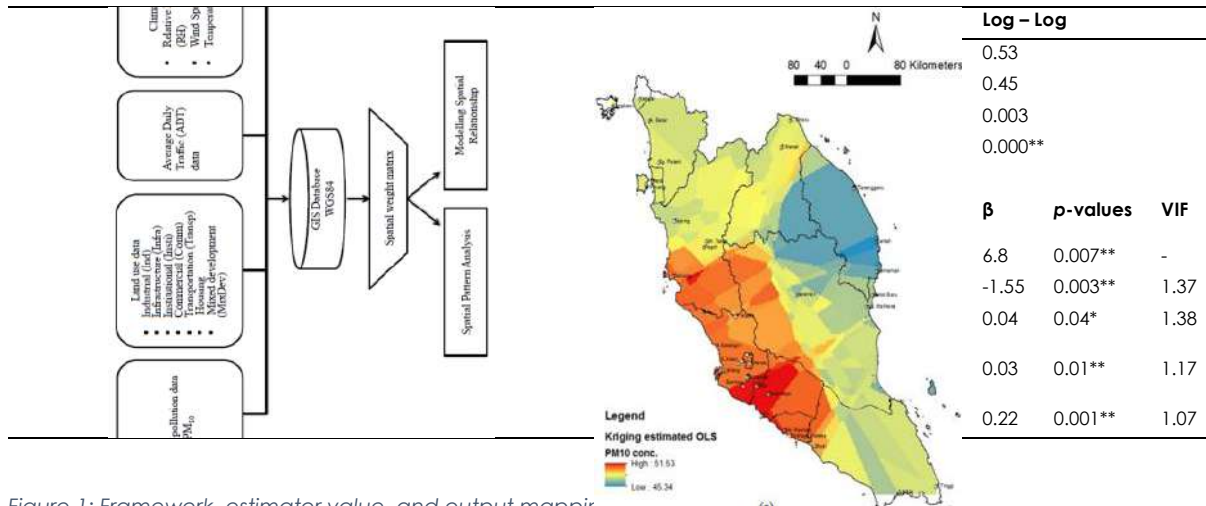

Figure 1: Framework, estimator value, and output mapping of spatial model.

Acknowledgment

The authors are grateful for the funding received from Ministry of Higher Education (R/FRGS/A08.00/012281/001/2016/000373). We thank the Malaysia Department of Environment and the Federal Department of Town and Country Planning for providing the required data.

References

- Geer, L. A. (2014). Identifying exposure disparities in air pollution epidemiology specific to adverse birth outcomes. *Environmental Research Letters*, 9(10). <https://doi.org/10.1088/1748-9326/9/10/101001>
- Jerrett, M., Gale, S., & Kontgis, C. (2010). Spatial modeling in environmental and public health research. *International Journal of Environmental Research and Public Health*, 7(4), 1302–1329. <https://doi.org/10.3390/ijerph7041302>
- Miller, H. J. (2004). *Tobler's First Law and Spatial Analysis*. 94(November 2003), 284–289.
- Tobler, W. R. (1970). A computer movie simulating urban growth in the detroit region. *Economic Geography*, 46, 234–240. <https://www.jstor.org/stable/143141>
- Ya'acob, S. H., & Mar Iman, A. H. (2020). The Spatial Influence of Environmental and Anthropogenic Factors on The Pattern of Air Pollution in Malaysia. *IOP Conference Series: Earth and Environmental Science*, 549(2020). <https://doi.org/10.1088/1755-1315/549/1/012011>

DESIGN DEVELOPMENT OF WASTE COOKING OIL SMART FILTRATION BOX

Asriana Ibrahim

Centre of Advanced Research Energy (CARE), Universiti Teknikal Malaysia Melaka (UTeM), Melaka, Malaysia
asriana@utem.edu.my

**Rafiq Hilmi Alias, Mohd Hakim Naquiddin Abdul Kadir, Mohd Hafidzal Mohd Hanafi, and
Nurul Hanim Razak**

Centre of Advanced Research Energy (CARE), Universiti Teknikal Malaysia Melaka (UTeM), Melaka, Malaysia
rafiqhilmi100@gmail.com, mohdhakim.hn@gmail.com, hafidzal@utem.edu.my, nurulhanim@utem.edu.my

Highlights: Pouring waste cooking oil (WCO) down the drain leads to clogging and fatberg. WCO can be considered a cost-effective renewable feedstock for bio-based material production if properly collected and recycled. Thus, the WCO Smart Filtration Box was designed to treat and improve the physicochemical properties of WCO, which can be reused for biomaterial production. The box's design uses an intelligent Arduino microcontroller and temperature sensor for the two-stages filtration system. Furthermore, this design offers an automated control-based system for WCO filtration that can be used as home appliances and small-scale biomaterial industries to recycle WCO effectively.

Key words: Waste Cooking Oil (WCO), Oil Filtration, Smart Oil Filtration System, Arduino.

Introduction

Restaurants, hotels, and kitchens regularly produced large quantities of waste cooking oil (WCO). It is estimated that 1 million tons per annum of WCO is generated in Europe (Lopes et al., 2019). Dumping WCO into landfills and rivers causes environmental problems, such as soil and water pollution (Tsai, 2019). Besides, pouring the WCO into sewerage leads to fatberg and promotes breeding pests that may affect human health. To solve these problems, WCO has been recycled to produce bio-based products. However, the polar compounds in WCO, such as free fatty acids that may harm humans' health, should be removed before WCO can be reused (Dobarganes & Márquez-Ruiz, 2015).

Various technology has been used to remove the impurities from WCO (i.e. adsorption and filtration). A study shows significant physicochemical improvement on treated WCO using adsorption and filtration (Hafidzal et al., 2015). Recent research uses Magnesol filter powder in the filtration process to reduce the formation of the polar compounds in frying oils (Xu et al., 2019). They also claim that oil filtration is an essential step to extend the frying life of oils. Therefore, WCO Smart Filtration Box was designed by applying adsorption and filtration technology to recycle the WCO.

Design Development

Quality Function Deployment (QFD) is a structured methodology that helps translate customer requirements into design specifications (Erdil & Arani, 2019). There are three stages of the QFD method used for this project: data collection, concept generation, and concept selection.

At the first stage, all the customer requirements information is collected using documentation techniques in which by gathering data about the characteristics of the oil filtration products in supplier companies (Bolar et al., 2017). Four customer requirements have been identified in this stage: functionality, user-friendly, durability, and cost. The design specifications for customer requirements have been recognized: safety, portability, compact design, easy to operate, automated system, high quality, and affordability.

Then, the second stage is a procedure to generate the best alternative to produce a creative concept design. The method used a set of customer requirements and design specifications to produce results in an array of product concept design alternatives. Lastly, in the concept selection stage, the best concept design is selected for prototype development and testing. The selection is made by comparing the relative strengths and weakness of the alternative concepts.

Conceptual Design

This design has three compartments which are collection, membrane filtration and storage of treated WCO. The collection part consists of a WCO insertion area with a cover and a first-stage filtration system to remove solid materials dispersed in the oil. After the first filtration process is done, the oil will go to the second stage filtration system. Here, membrane filtration is used to adsorb the polar compound in the oil. Besides, gravitational sedimentation also applied in this part to remove the retain solid particles. The design of the filter is to ease the removal procedure for the cleaning process. Lastly, the treated oil will go to the storage area for cooling down purpose. In addition, a handle and wheels are mounted at the top and bottom of the design, respectively, to allow the device to be removable for the filter cleaning process.

An intelligent Arduino microcontroller and temperature sensor are used in this design for the two-stages filtration system. The system allows insertion of the WCO at room temperature. Still, the filtration process is performed at a temperature of 30-50°C, where the WCO is heated using an electric heater operated by an automation system.

Three-dimensional computer-aided design drawings have been done using SolidWorks 2018. The drawings preparation is an essential process before prototype development to ensure all parts are designed with accurate dimensions. The basic shape of the design is a rectangular L-shape with 750mm length, 450mm in width and 1035mm in height. The assembly view of the conceptual design is shown in Figure 1.

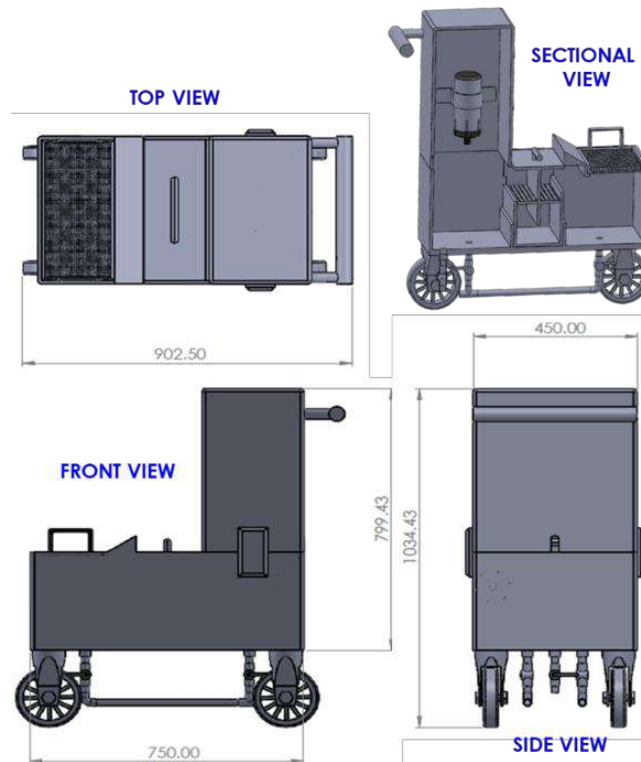

Figure 1: Assembly view of the conceptual design.

Conclusion

This device is designed to raise awareness of the importance of recycling WCO. It is ideal for use as a home appliance as it allows the WCO to be used repeatedly with good quality. Besides, it also has commercial value for small-scale biomaterial industries that used recycled WCO as a primary raw material for their products. Moreover, it can reduce pollution and increase environmental awareness towards Malaysians.

Acknowledgement

We are grateful for the sponsor by Commercialization Center (UCC), Universiti Teknikal Malaysia Melaka.

References

- Bolar, A. A., Tesfamariam, S., & Sadiq, R. (2017). Framework for prioritizing infrastructure user expectations using Quality Function Deployment (QFD). *International Journal of Sustainable Built Environment*, 6(1), 16-29.
- Dobarganes, C., & Márquez-Ruiz, G. (2015). Possible adverse effects of frying with vegetable oils. *British Journal of Nutrition*, 113(S2), S49-S57.
- Erdil, N. O., & Arani, O. M. (2019). Quality function deployment: more than a design tool. *International Journal of Quality and Service Sciences*.
- Hafidzal, M. H. M., Razi, M. Z. M., Hamzah, A., Razak, N. H., Zulkafli, N. I., Abdollah, M. F. B., Shamsudin, A., & Roslizar, A. (2015). Potential of mixed Zingiber Officinale and Garcinia Atroviridis as a treating medium for used cooking oil. *ARPN Journal of Engineering and Applied Sciences*, 10(17), 7784-7787
- Lopes, M., Miranda, S. M., Alves, J. M., Pereira, A. S., & Belo, I. (2019). Waste cooking oils as feedstock for lipase and lipid-rich biomass production. *European Journal of Lipid Science and Technology*, 121(1), 1800188.
- Tsai, W. T. (2019). Mandatory recycling of waste cooking oil from residential and commercial sectors in Taiwan. *Resources*, 8(1), 38.
- Xu, L., Yang, F., Li, X., Zhao, C., Jin, Q., Huang, J., & Wang, X. (2019). Kinetics of forming polar compounds in frying oils under frying practice of fast food restaurants. *Lwt*, 115, 108307.

ASTAX-FEED

Zuharlida Tuan Harith

Fakulti Industri Asas Tani, Universiti Malaysia Kelantan Kampus Jeli, 17600 Jeli, Kelantan
zuharlida@umk.edu.my

Suniza Sukri, Nik Nur Azwanida Zakaria, Fatin Nursabriena Mohd Sabir, Fatin Syuhada Remlee

Fakulti Industri Asas Tani, Universiti Malaysia Kelantan Kampus Jeli, 17600 Jeli, Kelantan
suniza@umk.edu.my, azwanida@umk.edu.my, sabrienafatin@gmail.com, fatinsyuhadaetoo@gmail.com,

Highlights: Astax-Feed is a fish feed formulated with enrichment of *Haematococcus pluvialis* that aims to increase the aesthetic value of red tilapia fish at the same time increase the health of the fish. Astaxanthin powder is added into the commercial fish feed that are lacking of natural feed colourant aiming to increase the red pigmentation in the red tilapia. Furthermore, astaxanthin is known to has high antioxidant activity and subsequently helping to produce healthy fish. This innovation has high impact to the farmer where healthy and highly pigmented red tilapia is produced. The highly pigmented red tilapia will increase the purchasing power among consumer as the aesthetic of the tilapia will attract the consumer to purchase the tilapia.

Key words: *Astaxanthin, Tilapia, Feed*

Introduction

Astaxanthin is one of the most important carotenoids among others that has vast applications in the pharmaceutical, aquaculture and food industries. The United States Food and Drug Administration (US FDA) (60 FR 18738, 13 April 1995) has approved the use of astaxanthin (E161) as a food colourant in animal and fish feed, and the European Commission (EC) also approved the use of natural astaxanthin as a food dye, in 2003. Astaxanthin that are available in the market are mainly sourced from microalgae, yeast and synthetically produced.

Apart from that, astaxanthin is rich with antioxidant. It could intensify the health and growth of red tilapia fish. Also, at the end of this research, one of the things that are being expected is the rate of death will be decrease if compared with control without astaxanthin used. The antioxidant properties preventing the degradation caused by rancidity in food products (Ponsano et al., 2014).

Given this, because of the ease of farming, tilapia fish are well known as fish products and have been widely marketed worldwide for human consumption. Therefore, with enhancing the value on fish feed, it will give improvement for broodstock performance. Finally, the analysis of astaxanthin used in fish feed diets will provide valuable information about the possible effect on colour and carotenoid content of various colorants present in tilapia fish feed (Ponsano et al., 2014)

Content

Astaxanthin serves as a source of pigmentation in aquaculture (Zhang et al., 2014). By conducting this research, the effect of astaxanthin enrichment in their diet could solve several issues with red tilapia including the pale colour problem and the increase the health of fish available in the current market. Customers are more attracted to purchase because the perceived first attribute and the selection criteria for determinants are color.

Astaxanthin powder from *Haematococcus pluvialis* (microalgae) is added into the commercial fish feed that are lacking of natural feed colourant aiming to increase the red pigmentation in the red tilapia. Pigments that are responsible to give Tilapia its red colour is known as carotenoids on which fish consumed through diet intake.

Most of red tilapia available in the market are farmed either in pond or caged. One of the issue being raised is that the red pigmentation in farmed red tilapia is low, hence affecting the aesthetic of the fish. However, tilapia does not has the capability to metabolically synthesized the red pigment but need to be included to their diet. Meanwhile, the purchasing behaviour of the consumer is very much related to the aesthetic value of the fish.

Due to the pale colour of Red Tilapia that are widely marketed, it indirectly indicates the presence of pigments in their diet are low due as most Tilapia in Malaysia are farmed in environment that are lacking of natural source of pigments (microalgae derived) such as in cage and ponds. Therefore, this innovation explore the potential of astaxanthin enrichment to tilapia feed, to subsequently increase the red pigmentation in red tilapia.

This innovation has high impact to the farmer where healthy and highly pigmented red tilapia is produced. The highly pigmented red tilapia will increase the purchasing power among consumer as the aesthetic of the tilapia will attract the consumer to purchase the tilapia.

From this study, it showed that the feed that formulated did not only give an effect on skin, but also the fillet (Table 1). When tilapia ingest the ASTAX-FEED, there were slowly transformed to astaxanthin in the gut. When tilapia get sufficient amount of feed, excess will be deposited as astaxanthin to give red color to flesh of fish. The findings from this study showed similar results from a study from (Yasir & Qin, 2010). Diet with the addition of 100 ppm astaxanthin in false clownfish *Amphiprion ocellaris* were capable to substantially increase the red hue by the end of the 5th week.

Table 1: Color intensity on fillet of *Oreochromis niloticus* sp. fed diets after 6 weeks of feeding.
 Control- no astaxanthin enrichment, ASTAX-FEED- 8% astaxanthin enrichment

	SKIN		FILLET	
	Control	ASTAX-FEED	Control	ASTAX-FEED
L*	47.7 ± 5.94	52.2 ± 3.05	33.3 ± 0.87	31.61 ± 1.55
a*	1.24 ± 0.11	1.77 ± 0.29	8.57 ± 1.20	10.16 ± 1.42
b*	6.25 ± 0.69	8.19 ± 0.36	9.53 ± 0.41	8.37 ± 0.10

L* - lightnes; a* - redness; b* - yellowness

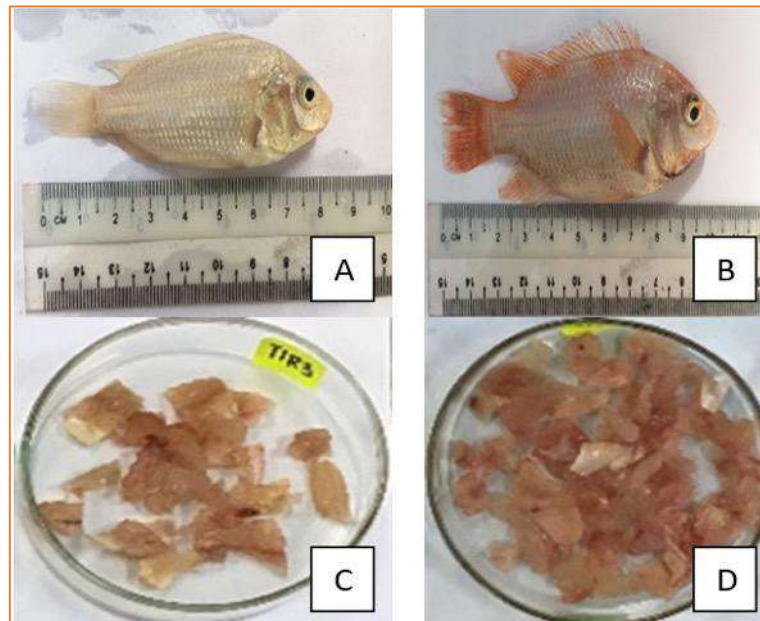

Figure 1: Physical observation on skin and fillet of *Oreochromis niloticus* sp. fed with ASTAX-FEED and control.

A: Control, B: ASTAX-FEED, C: Fillet of control, D: Fillet of ASTAX-FEED

Acknowledgement

We would like to thank UMK-Fund for the grant provided to carry out this research project (R/FUND/A0700/00668A/001/2020/00739)

References

- Carvalho, C. C. C. R. De, & Caramujo, M. J. (2017). Carotenoids in Aquatic Ecosystems and Aquaculture : A Colorful Business with Implications for Human Health. 4(April). <https://doi.org/10.3389/fmars.2017.00093>
- Ponsano, E. H. G., Grassi, T. L. M., Santo, E. F. E., Marcos, M. T. S., Cavazzana, J. F., & Pinto, M. F. (2014). Color and Carotenoids in Tilapia Fish Fed Different Carotenoids. August.
- Rodriguez-amaya, D. B. (2016). ScienceDirect Natural food pigments and colorants. Current Opinion in Food Science, 7, 20–26. <https://doi.org/10.1016/j.cofs.2015.08.004>
- Zhang, W., Wang, J., Wang, J., & Liu, T. (2014). Bioresource Technology Attached cultivation of *Haematococcus pluvialis* for astaxanthin production. Bioresource Technology 158, 329–335. <https://doi.org/10.1016/j.biortech.2014.02.044>.

PINE-COOKIES

Ho Pei Zheng

Fakulti Industri Asas Tani, Universiti Malaysia Kelantan Kampus Jeli, 17600 Jeli, Kelantan
zuharlida@umk.edu.my

Zuharlida Tuan Harith, Nik Nur Azwanida Zakaria

Fakulti Industri Asas Tani, Universiti Malaysia Kelantan Kampus Jeli, 17600 Jeli, Kelantan
zuharlida@umk.edu.my, azwanida@umk.edu.my

Highlights: Fruit waste is the one of the leading causes of municipal waste that lead to environmental problems. The possibility of pineapple cores to serve as non-gluten flour which is suitable for those peoples have non-celiac gluten sensitivity. Pineapple core also contains bromelain which is a substance that breaks down proteins effectively. PINE-COOKIES is developed using non-gluten flour from pineapple cores as substituting to wheat flour with a high nutritional values. Pineapple core flour (100% w/w) has been used in the formulation of PINE-COOKIES and widely is highly accepted during customer survey.

Key words: waste to wealth, pineapple core, bromelain, non-gluten flour

Introduction

In the recent years, the consumption and production of different varieties of fruits is increased along with the rise of economic development in Malaysia. However, the food waste produced is about 1.3 billion tons in a year, with the major contributor comes from fruits and vegetables waste. The non-edible part of fruits such as skins, seeds, and fruits residue which contribute to generate vast quantities of wastes in agriculture sector. The fruit waste is the one of the leading causes of municipal waste that carry out the environmental problems (Deng et al., 2012).

The study of non-gluten flours production and texture analysis of cookies can be a basic learning paradigm for the related parties in the flour production. The research can promote the utilization of fruit waste in Malaysia. This utilization of fruit waste can be developed into a new food product in food industries and may promote the economic development. This study was conducted in order to contribute further research on commercializing flour products in the market. Non-gluten flour from pineapple cores for cookies recipes can be developed. This research can be used by the food industrialists and developers in order to manufacture their food based products in the future.

Content

This study was conducted in order to contribute further research on commercializing flour products in the market. The use of fruit industrial waste in the processing new foods represents an important new step for the food industry.

Pineapple core contains bromelain which is a substance that breaks down proteins effectively. It can be extracted from the core and stem of pineapple. Bromelain is one of the potential digestive benefits, preventing cancer and inflammation. The nutritional value of pineapple is high levels of fibers, vitamin C and minerals including copper and manganese (Miranda et al., 2018).

Development of non-gluten flour from fruit waste for cookies recipes is useful as reference for further study. This utilization of fruit waste can be developed into a new food product in food industries and may promote the economic development. This study also considered as basic learning paradigm for the related parties in the recycling waste. Proximate analysis was conducted in this study including ash, energy value, carbohydrate, moisture content, crude fat, crude fibre, and crude protein.

The purpose of this innovation was to develop non-gluten flour from pineapple cores as substituting to wheat flour. Designing the cookies is the main factor for the consumer acceptability to determine and produce a successful developed product with improved the nutritional value. Thus, pineapple core flour was incorporated into corn flour at different ratios (0:100, 100:0, 70:30, 60:40, 50:50) to prepare cookies. Proximate analysis was conducted to determine nutritional composition of pineapple core flour including ash, carbohydrate, crude fibre, crude protein, moisture, and crude fat. The best formulation was found out when 100% pineapple core flour was used in the cookies.

Hence, reuse the waste from fruit residues would reduce the pollution, low cost, and provide the ingredients in high nutritional values. Some people cannot consume gluten because it can cause harmful to their small intestine. In fact, people often mistake intolerance of gluten for wheat allergy which an immune response to protein in wheat. Thus, this research was carried out to develop non-gluten flour from pineapple cores as substituting to wheat flour. This utilization of fruit waste can be developed into a new food product in food industries and may promote the economic development. This study was conducted in order to contribute further research on commercializing flour products in the market. Non-gluten flour from pineapple cores for cookies recipes can be developed. In terms of marketability or profitability of the innovation, this research can be used by the food industrialists and developers in order to manufacture their food based products in the future.

Parameter (%)	Pineapple Core Flour
Ash	0.47±0.15
Moisture	3.49±2.83
Crude Protein	3.46±0.062
Crude Fat	1.34±0.32
Crude Fibre	0.0126±0.000849
Carbohydrate	91.24 ± 2.93
Energy (Kcal)	390.81±9.11

Table 1:
The proximate
analysis of
pineapple core
flour.

References

- Ahmad. (2001). Development in Rural Poverty Alleviation. *Sustainable Agriculture System in Malaysia*, 10.
- Akalu & Geleta. (2019). Comparative Analysis on the Proximate Composition of Tubers of *Colocasia Esculenta*, *L. Schott* and *Dioscorea Alata* Cultivated in Ethiopia. *American Journal of Bioscience and Bioengineering* 7(6), 93-101.
- Gezehagn et al. (2019). Value Chain Analysis of Pineapple (*Ananas Comosus*) Production and Marketing from Traditional Agroforestry System, Southern Ethiopia. *Food Science and Quality Management* Vol.84.
- Lama et al. (2010). Utilization of Pineapple Waste: A Review. *Journal of Food Science and Technology Nepal* Vol 6, 10-18.
- Singh, R. (2016). Development of fiber enriched bakery products by incorporating. *International Journal of Advanced Research in Biological Sciences* Volume 3, Issue 6, 222-226.

LA PANCA:
THE FURNITURE FOR THE BOTTOM BILLION

Azli Abdullah

Faculty of Architecture and Ekistics, Universiti Malaysia Kelantan, 16300 Bachok, Kelantan, Malaysia
azli.ab@umk.edu.my

Nik Nurul Hana Hanafi, Siti Aisyah Muhammad, Najah Md Alwi, Nor Hafizah Anuar, Nuzul Haqimi Muhammad, Mhd Hafiz Karami Mhd Zain, Muhammad Rizal Khairuddin, Juliza Mohamad, Yasmin Mohd Faudzi

Faculty of Architecture and Ekistics, Universiti Malaysia Kelantan, 16300 Bachok, Kelantan, Malaysia
hana.h@umk.edu.my,aisyah@umk.edu.my, najah.ma@umk.edu.my, norhafizah@umk.edu.my,
nuzulhaqimi@umk.edu.my, hafiz.k@umk.edu.my, rizal.k@umk.edu.my, juliza@umk.edu.my, yasmin.mf@umk.edu.my

Highlight: This product aims to produce innovation in the production of prefabricated furniture using 'appropriate technology'. The product production method incorporates traditional architectural, structural elements such as 'tanggam system', which is translated through the strength of the building structure. La Panca is driven by the concept of the bridge structure. It aimed to utilize the usage of friction and gravity as part of the structural idea. La Panca structure designed mainly of wooden poles and beam without any fasteners. Timber is a sustainable material, and it was suitable for heavy-duty usage. This idea was influenced by the traditional craftsman and 'tanggam' system in Malay architecture construction techniques. From this idea, we try to develop and enhance the method in order to commercialize the concept. La Panca interlock system makes the two mechanisms in this product function manually. It is easier to install and affordable to the people.

Keywords: *La Panca, appropriate technology, furniture, Bottom Billion,*

Introduction

Urbanization is a general term that refers to the displacement meant of people from the rural and urban areas to the city for social and development purposes (Hadi, 2010 & Wahid, 2014). Rapid urbanization has taken place worldwide, and Asia is no exception (Aziz & Hadi, 2017). It has passed through all the regions, including Asia, either East Asia or South Asia. The main result of the urbanization process is that traffic congestion over the entire area is due to the urban population dominated by newcomers from rural and urban areas. These groups are exploited by development and are regarded as human resources to drive the city's economic, social, and political outcomes with the presence of this group in the city. According to Lamry (2014) and Dahlan (1997), most informal settlements redeveloped through privatization will result in the urban poor moving elsewhere. However, the re-settlement process of these low-income communities poses enormous financial problems for them. We admit that "architecture is about people, culture and land: the architecture flourished when the people developed, and it is portrayed through architecture out of people's determination". Street furniture is a collective term for objects and pieces of equipment installed along the street, road and any public space for various purposes. La Panca is designed to fit this purpose and will be benefiting people, especially the Bottom Million.

La Panca is by Meranti wood. It was easier to find with minimal price. Besides, it also easy to carry. This product had immense potential in the furniture industry. It can also generate income for local people for the local craftsman to sustain the local community. Besides, this product can also be produced by yourself, without the help of many employees. To create it, this product only needs to employ a minimum of two people. La Panca can also be owned by the low-income group. They can also produce these products at home without the use of large machines.

Design Development

After the introduction of the Industrial Revolution 1, the industry sector played a major role in developing the global economy. The same situation is happening in Malaysia. The industry has resulted in the demand for human resources and employment, resulted in a shift pattern of economic in the Malay community. Currently, furniture product is made in a factory using machinery and low skill labour. This situation is forcing and affecting traditional construction systems. Malay carpentry skills are increasingly threatened due to the rural-urban migration process. Then, the impact of globalization and the pace of urbanization affected directly the Malay craftsmanship skills disappear. The furniture industry is threatened by the problem of skilled workers in the production of wood-based products. La Panca is an innovative piece of furniture introduced to highlight the art of Malay craftsmanship through the construction of more innovative, creative, durable and practical ways. This product can conserve Malay skills through 'tanggam' joinery system that existed for centuries.

Background Innovation

La Panca is an innovative product that combines the traditional method of 'tanggung' joinery system and structural strength. La Panca was introduced to demonstrate the strength of a durable and portable structure. In addition, this product does not require many human resources, portable installation, no use of machines and high-quality products. This advantage makes La Panca is a product that will provide jobs opportunity and income generators for the B-40. Since it does not require high costs and have a high quality, this product can offer job opportunities for the Malay community, especially in the rural area.

Advantages of La Panca

Of course, La Panca is a greater choice for anyone to use. Simple installation techniques, structural strength and ease of maintenance are the main keys of La Panca (Figure 1.0). In addition, it is able to use materials other than wood, such as metal and plastic, for future innovation. But what is important, it is able to generate income for the poor and improve their quality of life. As described earlier, the urban poor is the largest group in Malaysia. In addition, the production of this product will provide jobs opportunities to the local community, rural area and prevent rural-urban migration.

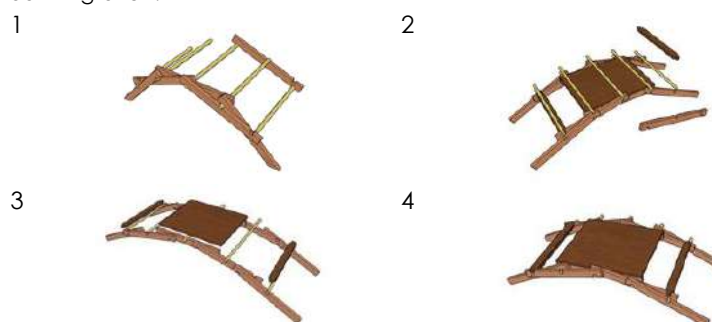

Figure 1.0: La Panca installation process (Source: Azli Abdullah, 2021)

Commercial Values

La Panca has its own strengths to be of high commercial value. These 'appropriate technology' products do not require a monopoly and capitalist system that will turn the poor people into 'tools' for economic development. With the existence of this product, the rural communities are able to create job opportunities in their communities by themselves. It is also able to preserve the Malay community rather than migrate to the cities. After changes to the non-agricultural sector of agriculture to the Malay people, they can now carry out innovative products in rural communities and market these products to the city. Population explosion and pace of urbanization in the city have a significant impact on the cramped living space in the city. Moreover, the development of low-cost settlements has resulted in social communities not having a space to congregate. La Panca offers the only product innovation capable of overcoming this problem.

Novelty

his innovation is the combination of bridge technology and the Malay traditional 'tanggung' system. The variety of modern and traditional construction techniques will produce a product that can be commercialized and not available in the market.

Acknowledgement

We would like to thanks Muhammad Afifi Bin Ahmad Fitri, Muhammad Syafik Bin Syazwan, Ahmad Firdaus Bin Muhammad, Nur Aqilah Binti Arshad and Mohana A/P Supramaniam for making this successful product.

Reference:

- Aziz, N., & Hadi, A.S. (2017). Linking Urban Form to a Liveable City. *Malaysian Journal of Environmental Management*8. Pp. 10- 17.
- Dahlan, H., M., (1997). *Urbanisasi Alam Kejiwaan Sosial dan Pembangunan*. ISBN: 96 79423662. UKM Press. Malaysia.
- Lamry, M., N., (2014). *Biografi Ishak Shari: Pejuang Bumi Semua Manusia*. ISBN: 9789674122522. UKM Press. Malaysia
- Hadi, A.S. (2010). *Urbanisasi di Malaysia: Mengaitkan Kepelbagaian Proses ke Bentuk Perbandaran*. *Malaysian Journal of Environmental Management*11 (2) (2010). Pp. 21-31.

SONATA: MOBILISED ARCHITECTONIC STREET FURNITURE WITH MULTI-TRANSFORMATION

Siti Aisyah Muhammad

Faculty of Architecture and Ekistics, Universiti Malaysia Kelantan, 16300 Bachok, Kelantan, Malaysia
aisyah@umk.edu.my

Nik Nurul Hana Nik Hanafi, Juliza Mohamad, Najah Md Alwi, Nor Hafizah Anuar

Faculty of Architecture and Ekistics, Universiti Malaysia Kelantan, 16300 Bachok, Kelantan, Malaysia
hana.h@umk.edu.my, juliza@umk.edu.my, najah.ma@umk.edu.my, norhafizah@umk.edu.my

Highlights: The street furniture categorised as sculptural furniture that consists of function and artistic product. The function such as bench and shelter reinvented with artistic design attracts pedestrians and also become the landmark of the specific area. This study aims to introduce an architectonic street furniture that can be mobilised and able to reform according to the specific needs. The method of case study was applied for this project whereby the ergonomic and anthropometric of the potential users were considered. The result was examined to design the most suitable street furniture that fulfil the artistic mobilised street furniture namely SONATA. SONATA able to reform up to six seating functions and mobilised to any location desired offering the social distancing application. The innovation of Sonata has potential to be commercialised and be part of the street furniture to improve the alleys, pedestrian walkway and park.

Key words: SONATA, street furniture, Beethoven, pandemic, bench, sustainable

Introduction

The name SONATA is borrowed from a much-loved piece from German composer Beethoven's expression of emotions-the Moonlight Sonata. The sensuous rhythmic keys from the grand piano presented multi rhymes with it slow, hypnotic set of arpeggios determined to not follow the status quo for its genre. This project represents a similar nature for an item of architectural street furniture with multi transformations to achieve optimum usage as a street bench in public spaces such as a park or pedestrian walkway. Outdoor furniture plays a distinct role in connecting people, be it in public domain such as a public park or in a private setting as in a yard or garden. It provides more than just functional features but also able to make a difference to the overall look and feel of the outdoor setting. Through certain design and concept, it is able to enhance the uniqueness of a place hence it contributes in creating a vibrant, lively environment. It may act as a focal point, a meeting point and even offer visual pleasures through its design. While there are numerous selections of outdoor benches readily available, not many designs offer flexibility to cater for different usage in outdoor spaces. Flexible furniture with convertible and movable features presents numerous potential strategies for the future. One unit of this timber furniture can be transformed into multiple designs and usage hence it is able to satisfy various needs for various activities. This strategy is able to reduce material resources thus reducing environmental impact in the long run. Flexible furniture could influence spatial flexibility as it is able to improve space efficiency, particularly when it comes to activity variety, space capacity and usage intensity (Oday, Omar & Hussien, 2014). In this respect, the same space will be able to accommodate various activities by transforming the furniture into desired design to suit the needs of activities, making it adaptable to the users' needs.

Design Development

Traditionally, street furniture or outdoor furniture are constructed as static pieces. Most street furniture, if not all, are designed to be immobile and available in fixed, inflexible sizes and design. The physical appearance of this furniture will remain unchanged in the way it is manufactured. The current design would limit various outdoor activities, especially in limited outdoor areas or parks hence it would reduce the flexibility for the public to enjoy the outdoors. For that matter, it is worth considering the need for more flexible outdoor furniture so that the outdoor space could accommodate different activities and events users need to. It is viable to rethink and reinvent the design of street furniture in order to solve numerous concerns and issues. Thus, in this study, we proposed a new invention of flexible street furniture, with the intention to improve current street furniture design while offering place-making solutions. Named as Sonata, this study aims to introduce an architectonic street furniture that can be mobilised and able to refresh the overall outlook of outdoor spaces potentially parks, alleys, and even campuses. The term 'social distancing' is now part of the everyday vocabulary in times of the global Covid-19 pandemic outbreak. How the pandemic has completely reformed our daily activities, especially when out in public spaces, has created new opportunities for a creative renaissance in commercial spaces. Thus, it resulted the objectives of this invention as followed:

1. To propose a flexible street furniture, accommodate social distancing without compromising its optimum usage in public spaces
2. To promote an alternative street furniture design fulfilling the user's need with multi-transformation
3. To encourage the use sustainable material for the street furniture

Background Of Innovation

This project was initiated to produce an outdoor bench with flexibility in mind. The design incorporates the idea of modularity where the segmented design would allow for extension; therefore, users have the freedom to extend the length of this bench to accommodate extra people as needed. Approaches to outdoor furniture design are traditionally constructed to be fixed, immobile and static with limited intended activities. Furthermore, most of this furniture is mass-produced with minimal consideration of its artistic design and ergonomic aspects. This new invention of flexible street furniture SONATA draws upon its aims to contribute to street furniture design by offering design that can be transformed according to users' needs at any preferred outdoor location. This project also considers the requirements for allowing safe distances between members of the public while utilising public furniture.

Advantages Of Innovation

SONATA contributes to society and country in several ways; designed to accommodate social distancing without compromising its optimum usage. SONATA is a valuable asset as a street bench in public spaces. The way each segment can be manipulated and transformed in to multiple sitting positions and functions-based on user's preferences is crucial for its use in public space while safely observing social distancing. Also, one unit of this timber furniture offers multiple functions for multiple activities. This strategy can reduce environmental impact in the long run of its productivity and usage.

Commercial Values

SONATA has strong potential for commercial value as the design fulfils various user's needs for any situation in urban and public space. The modular concept approach for this furniture item allows for the production of the bench in multiple length from single seater to the desired length. SONATA in its unique design applied the ingenious configuration for engineering of structural design with its multi transformation purpose and functions.



Figure 1: Multi-Transformation of SONATA up to Six Sitting Designs

Acknowledgment

We are grateful for the excellent contributions from Muhammad Rizam Muda, Muhammad Azffar Hakimin Mohammad Hadifar, Muhd Hanis Abdul Halim, Ainan Sufia Kalid, Amirah Syatiah Mat Tarmizi in completing the project.

References

Oday, Q. A., Omar, A. S., & Hussien, S. A., (2014). Impact Of Flexibility Principle On The Efficiency Of Interior Design. International Transaction Journal of Engineering, Management, & Applied Sciences & Technologies, Vol. 3 (3), pp. 195-212

GINOC: EDIBLE FOOD DYE

Shamsul Muhamad

Fakulti Industri Asas Tani, Universiti Malaysia Kelantan, Kampus Jeli, Kelantan, Malaysia
Shamsul.m@umk.edu.my

Saliza Anida Salleh

Sekolah Kebangsaan Jeli (1), Jeli, Kelantan
salizaanida@gmail.com

Highlights: GINOC (GINOC dye) is a liquid dye derived from the local edible plant, *Gynochthodes sublancolata* (Rubiaceae). It is used to colour starchy food such as rice and vermicelli with dark purple colour. This dye is self-preserved due to its antibacterial and antioxidant properties. Furthermore, it is non-toxic as determined by the brine shrimp lethality test and cytotoxic assay.

Keywords: Dye, purple, anthocyanins, plant, extract, rice.

Introduction

Colourants have a significant factor to food manufacturers as additives to enhance consumer acceptability of processed food (Coultrate & Blackburn 2018; Neves et al. 2021). Generally, food colourants are categorized into two types according to sources: the first is artificial colourants synthetically derived from coal tar or petroleum, and the second is natural colourants extracted from plants, animals, or microorganisms (Rodriguez-Amaya 2019). Due to colour stability in various processing and storage conditions, synthetic food colourants are used extensively by food manufacturers.

However, synthetic food colourants are identified as a cause of severe health problems such as cancer, neurotoxicity, hypersensitivity, and hyperactivity-related disease among children (Amin & Al-Shehri 2018; Hastaoğlu et al. 2018). Hence, some synthetic food colourants are not permitted by the Food and Drug Authority (FDA), USA. (Corradini 2019). As a result, food manufacturer gradually replaces these harmful synthetic colourants with the healthy colourants (Coultrate & Blackburn 2018; Ramesh & Muthuraman 2018). Thus, we present GINOC dye derived from the local edible plant as a food colourant in this effort

Description of innovation, the ginoc dye

The physical form of the GINOC dye is the concentrated liquid extract with a green colour. This particular dye is produced from leaves of *Gynochthodes sublancolata* (Rubiaceae). Rice can be coloured with GINOC dye by mix 1 ml of GINOC dye with 100-gram rice and 300 ml water. Then, cook a mixture using rice cooker; and finally, a rice will be coloured with dark purple colour (FIGURE 1) (Norzaki 2020). The purple colour of rice is due to the presence of anthocyanins, i.e., cyanidin-3-O-glucoside chloride, cyanidin-3, 5-di-O-glucoside chloride, malvidin-3-O-glucoside chloride, malvidin-3, 5-di-O-glucoside chloride, and peonidine-3-O-glucoside chloride as determined by HPLC-DAD analysis.

GINOC dye has moderate antibacterial activity, inhibited the growth of *Vibrio cholerae*, *Salmonella*, *Edwardsiella tarda*, *Aeromonas*, *Flavobacterium* (Disc diffusion assay with inhibition zone between 8 mm-17 mm (Arif 2015). GINOC is considered not toxic as determined by cytotoxic assay and brine shrimp lethality test. The IC_{50} value of the cytotoxicity assay on cell lines, i.e., MCF-7, HT-29 and WRL-68, were more than 200 µg/ml. Whereas the LC_{50} value of the brine shrimp lethality test was more than 2,000 µg/ml. GINOC has moderate antioxidant activity (DPPH EC_{50} , 267.38 ± 6.21 µg/ml) (Ghani 2014; Ishak 2014).

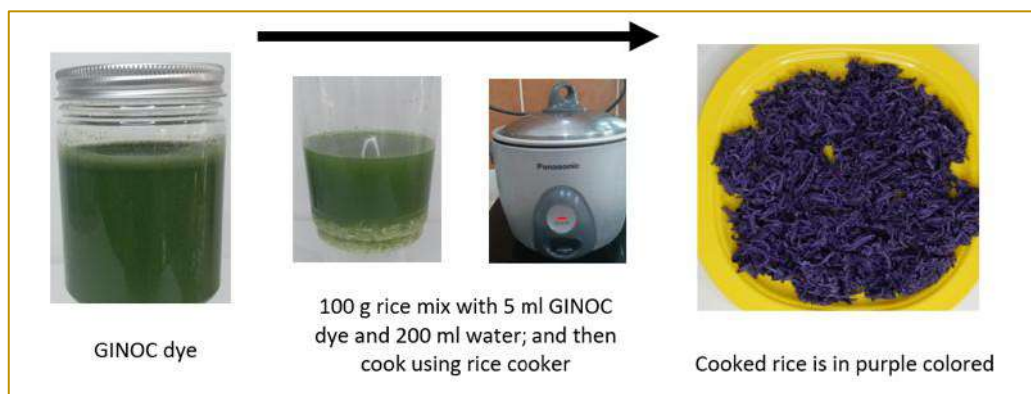

Figure 1: Method to colour rice with GINOC dye

Advantages Of Ginoc Dye Towards Education And Community

The advantage of GINOC dye as a food colourant can be increased consumer/society awareness and educate on the adverse effect of on consumption of synthetic food dye to their health. GINOC dye is safe and healthy since it derived from edible plant; and its does not contains preservative as well as has antioxidant property.

Commercial Value In Terms Of Marketability Or Profitability

This innovation is ready for market and sustainable production due to the abundance of source. We have already set up method for large scale planting and process. The retail price of 100 ml GINOC dye is RM 10.00, i.e., comparable to the price of the synthetic purple dye from the Star Brand.

Acknowledgement

The study funded by the Ministry of Higher Education (R/FRGS/A03.00/002788A/002/2011/00040).All data obtained from the thesis of undergraduate and postgraduate students at Fakulti Industry Asas Tani, Universiti Malaysia Kelantan. All of the laboratory works were entirely supervised by Dr. Shamsul Muhamad

References

- Amin, K. A., & Al-Shehri, F. S. (2018). Toxicological and safety assessment of tartrazine as a synthetic food additive on health biomarkers: A review. *African Journal of Biotechnology*, 17(6), 139-149.
- Arif, N.H.M. (2015) Biological activity and phytochemical study of purple pigment from *Gynochthodes sublancoolata* miq. Master's thesis, University Malaysia Kelantan.
- Corradini, M. G. (2019). Synthetic food colors. *Encyclopedia of Food Chemistry*, 291-296.
- Coultate, T., & Blackburn, R. S. (2018). Food colorants: Their past, present and future. *Coloration Technology*, 134(3), 165-186.
- Ghani, N.A. (2014). Antioxidant and antibacterial activity of acetone extract of pitang (*Gynochthodes sublancoolata*) Bachelor of Science thesis University Malaysia Kelantan
- Hastaoğlu, E., Can, Ö. P., & Vural, H. (2018). The Effects of Colorants Used in Hotel Kitchens in Terms of Child Health. *Avrupa Bilim ve Teknoloji Dergisi*, (14), 10-16.
- Ishak, N.I. (2014). Antioxidant and antibacterial activity of ethanol extract from *Gynochthodes sublancoolata*. Bachelor of Science thesis University Malaysia Kelantan
- Neves, M. I. L., Silva, E. K., & Meireles, M. A. A. (2021). Natural blue food colorants: Consumer acceptance, current alternatives, trends, challenges, and future strategies. *Trends in Food Science & Technology*.
- Norzaki, N.F. (2020). Colour analysis of rice incorporated with colorant derived from *Gynochthodes Sublancoolata* Miq (Rubiacea) leaves, Bachelor of Science thesis University Malaysia Kelantan
- Ramesh, M., & Muthuraman, A. (2018). Flavoring and coloring agents: health risks and potential problems. In *Natural and artificial flavoring agents and food dyes* (pp. 1-28). Academic Press.
- Rodríguez-Amaya, D. B. (2019). Update on natural food pigments-A mini-review on carotenoids, anthocyanins, and betalains. *Food Research International*, 124, 200-205.

THE INVENTION OF FISH FRY MOBILE, AUTOMATIC COUNTER (FRYMAC) USING ARDUINO UNO

Nur Aina Lyana Mohamad Ali¹

Politeknik Jeli Kelantan, Jalan Raya Timur Barat, 17600 Jeli, Kelantan, Malaysia
¹nurainalyanaMA@gmail.com

Nazrin Nazari², Norhaida Musril³ & Nik Muhammad Farhan Nik Mohd Sani⁴

Politeknik Jeli Kelantan, Jalan Raya Timur Barat, 17600 Jeli, Kelantan, Malaysia
²nazrinnazari0589@gmail.com, ³ciknorhaida@gmail.com & ⁴paan7543@gmail.com

Highlights: This study was an innovative invention of an automatic fish fry counting tool called FryMAC using Arduino Uno processor aims to help lecturers, students and aquaculture breeders particularly in facilitating the process of handling fish fry. This tool helps save time and simplifies handling so that the fish does not stress and fish calculations are more accurate than the manual method.

Key words: *Automatic fish counter, Arduino in Aquaculture.*

Introduction

Stocking density is one of the most important elements in aquaculture. Fish fry need to be harvested from the nursing tank in order to sort their size before it can be stocked into a farm pond or tank. Stocking density plays a crucial role in survival, growth, food intake as well as the production of the fish fry (Arifin et. al., 2019) as the higher the density may affect fish performance such as leading to individual fish competition over feed utilization (Abdel-Aziz et. al., 2016).

As to date, most fry counting methods for sampling were done manually either by farmers, as well as being practiced in aquaculture teaching and learning process. Manual fish counting is costly, uses too much apparatus and manpower besides very time consuming for the preparation and fry counting (Saha et al., 2018). All the apparatus must be set-up on site besides, which in unfortunate event the long-time taken could lead to fish stress (Silveria et.al., 2016) and death once the fry was already stock in the pond (Portz et. al., 2006).

Therefore, the fry mobile auto counter (FryMAC) was intended to overcome such problems. FryMAC body was integrated with Arduino Uno, an electric microcontroller that controlled the sensor by automatically detecting fish movement and displayed the counted fish through the LCD screen. It also builds using cheaper material and comes with wheels to simplify movement and storing. In addition, the user manual for the usage instruction and maintenance was documented to help FryMAC users.

Methodology

The invention started with the 3D drawing of FryMAC. FryMac comprises two main parts i.e. body part consist of main frame, holding tank, water pump, receiver tank and electronic part consist of Arduino breadboard, laser diode sensor and LCD screen (Figure 1). Fish fry (3-5 inches long) was placed in a holding tank. The water pump pushes the fish going through the laser sensor before finally falling into the receiver tank. The average number of fish detected by the laser sensor appeared at the LCD screen.

Table 1: Fish counting and time taken using manual counting and FryMAC

No.	Groups (3 replicate s each)	Fry Number			Duration (sec)	
		Manual count	FryMAC sensor	Actual number	Manual count	FryMAC sensor
1	Group 1	15	15	15	1 min	1 min
2	Group 2	33	30	30	3 min	2 min
3	Group 3	47	50	50	5 min	3 min 5 sec



Figure 1: Fish fry Mobile Auto Counter (FryMAC)

The data of average fish number as well as duration (time taken during fry counting) were recorded and summarized in Table 1. FryMAC sensor accurately detects all the fish that passed through the sensor compared to some miscounting of the manual human counting. The duration taken during fish counting was also manageable. The result showed that FryMAC can effectively cut the labour and operational cost, fast and easy fish handling, accuracy and could reduce fish stress due to lack of human intervention in the handling process.

Conclusion

For the conclusion, FryMAC can facilitate the process of fish counting quickly and accurately and can be taken anywhere whether in the hatchery, pond or tank. FryMAC are suitable and have great potential to be used by farmers, fisheries officers and teachers. With the rapid development of digital technology known as industrial 4.0, we are able to encourage the use of the internet of things (IoT) among students, lecturers, teachers and the aquaculture farming community. For further advance study, we suggest integrating the FryMAC with a weighing mechanism and using a smart approach like controlling data directly to the smartphone apps.

References

- Abdel-Aziz, M. F., Abou-Zied, R.M., Allam, S.M. & Mohammed R.A. (2016). Effect of Stocking Density and Water Exchange Period on Growth Performance, Feed Utilization and Body Chemical Composition on Rabbitfish *Siganus Rivulatus* Juvenile Under Laboratory Condition. *Egyptian Journal of Aquatic Biology & Fisheries* 20(3):15-33.
- Arifin, O. Z., Prakoso, V. A., Subagja, J., Kristanto, A. H., Pouil, S. & Slembrouck, J. (2019). Effects of Stocking Density on Survival, Food Intake and Growth of Giant Gourami (*Osphronemus goramy*) Larvae Reared in a Recirculating Aquaculture System. *Aquaculture* 509, 159-166.
- Badamasi, Yusuf. (2014). The working principle of an Arduino. 1-4. International Conference on Electronics, Computer and Computation, (ICECCO), 1-4.
- Portz, D. E., Woodley, C. M. and Joseph, J. C. Jr. 2006. Stress-associated Impacts of Short-Term Holding on Fishes. *Reviews in Fish Biology and Fisheries*. 16:125-170.
- Saha, S., Rajib, R. H. and Kabir, S., 2018. IoT Based Automated Fish Farm Aquaculture Monitoring System. *2nd International Conference on Innovations in Science, Engineering and Technology*, 201-206.
- Silverio F. J., Certal A. C., Mao de Ferro C., Monteiro J. F., Almeida Cruz J, Ribeiro R.,2016. Automatic System for Zebrafish Counting in Fish Facility Tanks. *International Conference on Image Analysis and Recognition*, 774-782.

GUAJAVA – A NUTRITIONAL PINK GUAVA POMACE POWDER

Khomaizon Abdul Kadir Pahirulzaman

Universiti Malaysia Kelantan, Jeli, Malaysia
khomaizon@umk.edu.my

Fazilawati Shaari, Nurhanan Abdul Rahman

Universiti Malaysia Kelantan, Jeli, Malaysia
fazilawatishaari@gmail.com, nurhanan.ar@umk.edu.my

Highlights: GuaJava Pomace Powder is a healthy and nutritious food product developed from pink guava pomace. It is prepared in powder form with the aims to increase its applications. This fruit powder is suitable to be used for bakery products such as bread and biscuits to improve their nutritional values and palatability. This valuable fruit powder is suitable to be consumed by children and adults and at an affordable price. By adding GuaJava to your ingredients list, you are helping to create a more sustainable environment.

Key words: *guava, pomace powder, fruit by-product, zero waste to landfill*

Introduction

A wide variety of agro-industrial residues from many fruit species are wasted every year, causing a harmful environmental problem. Some steps have been taken to use residues to produce and grow a range of value-added goods, such as bioactive substances used by the food, cosmetic and pharmaceutical industries (Schieber A et al., 2001). Guava pomace is one example of the processing waste generated after the manufacturing process and represents up to 15% of the original fruit (Jimenez-Escrig A et al., 2011). It consists of a mixture of peel, seed, and pulp rich in phenolic compounds with antioxidant potential.

Psidium guajava pomace powder is an essential source of fibre content. Otherwise, when using it in baked product formulations, it is important to consider that it contains a high amount of soluble dietary fibre (SDF). Moreover, fruit dietary fibre (DF) concentrates may lead to a better nutritional quality because of the presence of significant amounts of associated bioactive compounds (flavonoids, carotenoids, etc.) and their balanced composition of higher fibre content (Saura-Calixto, F., 1998).

The nutritional quality of bakery products seems relatively low because of the inferior dietary composition of the wheat grain. The substitution part of the organic plants such as guava has been advocated for the nutritional enrichment of these products and utilizing the better quality of bread with organic raw materials preferentially. Adding fruit by-product will improve the physicochemical properties of bread. Nutritionally, many studies have analysed in the scientific literature concerning consumption level and its nutritional value in foodstuff (Ponis et al., 2017). The consumption of cereal grain, including bread must have essential fibres, dietary carbohydrates, protein, vitamin B, vitamin E, iron, and trace minerals. Therefore, some cereals products such as bread, tortillas and rolls, ready-to-eat cereal, quick bread, and bread products were described as folate manganese, thiamin, niacin and zinc contribution to the human diet.

Bread is one of the most consumable foodstuffs around the worldwide. It is belief that bread created from wheat composite flour incorporates a principal part in nourishment determined from a composition containing micronutrients in arrange to boost its nutritional value. Generally, bread could be a common food made sourced from salt, flour, water yeast, and sugar. Additionally, the bread itself is a baked food product that is made from flour, which has been moistened, kneaded and fermented. The dough usually will impact the structuring three of the bread transformations after baking.

Furthermore, addition of other optional ingredients contributes to the flavour of variety breads, including guava pomace powders. Besides nutrition aspects, the advantage of using guava pomace powder ingredient in bread formulations includes higher fibre content may alter the nature and degree of negative effects such as reduced volume of loaf, increased firmness of crumb and darkened appearance (Henryk Jelen, 2012). Incorporation of fruit pomace powder had marked negative effects on colour of the bread with the increase in the level of supplementation and resulted in the darkening of the bread. However, colour and appearance is an important parameter for the likeability of the consumer and assists consumer in evaluating quality of bread. Thus, guava pomace tends to improve taste, aroma and acceptability of bread.

Content

Guava juice is a favourite food product from guava fruit, but it will cause the generated off by-products or wastes such as peels, outer leaves, and pulps. Reducing the wastes should be taken by converting the by-products into something useful. The pink guava is also very good to health because it contains high dietary fibre. Thus, this product innovation aims to produce pink guava pomace powder that can be used for bread making. Pink guava pomace powder (PGPP) was prepared by drying and ground into powder. Different percentages of PGPP were used to replace wheat flour in bread making. Physicochemical properties of the bread prepared using PGPP were evaluated. Results show that the hardness, springiness and chewiness of bread were significantly reduced when a higher percentage of PGPP was used. In addition, colour measurements showed a significant difference between

the control and bread prepared with PGPP. PGPP decreased the lightness of bread. Whereas, bread's redness and yellowness and moisture content were increased with a higher percentage of PGPP in bread.

The context of our product innovation is towards achieving zero food waste to landfill.

The advantages of our product innovation are:

1. We can reduce the amounts of wastes from guava that cause environmental problem.
2. GuaJava Pomace Powder can be used in making bread with higher fiber, lower calories and nutritional content.
3. Including GuaJava Pomace Powder in your pastry ingredients may alter the nature and degree of the pastry.

Nowadays, consumers perception on bread as low quality because of its nutritional content. Demand for health-oriented products such as low calories and high fibre products are increasing. Our product will be a good target for people who practice healthy lifestyle.

Acknowledgement

The authors thank Faculty of Agro Based Industry, Universiti Malaysia Kelantan for the laboratory facilities

References

- Fulgencio Saura-Calixto. (1998). Antioxidant Dietary Fiber Product: A New Concept and a Potential Food Ingredient. *Journal of Agricultural and Food Chemistry*, 46 (10), 4303-4306.
- Henryk Jelen. (2012). *Food Flavors. Chemical, Sensory and Technological Properties*. CRC Press.
- Jiménez-Escrig, A & Gómez-Ordóñez, E & Rupérez, Pilar. (2011). Seaweed as a source of novel nutraceuticals: Sulfated polysaccharides and peptides. *Advances in food and nutrition research*. 64. 325-37.
- Ponis, S. T., Papanikolaou, P., Kafimertzoglou, P., Ntalla, A. C., & Xenos, K. I. (2017). Household food waste in Greece: A questionnaire survey. *Journal of Cleaner Production*, 149, 1268-1277.
- Schieber, A., Stintzing, F. C., Carle, R. (2001). By-products of plant food processing as a source of functional compounds-recent developments. *Trends in Food Science & Technology*, 12: 401-413.

PRECISE FERTILIZATION WITH DRONE-BASED TECHNOLOGY

Muhammad Nurfaiz Abd. Kharim

Universiti Malaysia Kelantan, Jeli Campus, Jeli, Kelantan, Malaysia
 nurfaiz@umk.edu.my

Aimrun Wayak, Abdul Rashid Mohamed Shariff, Ahmad Fikri Abdullah

Universiti Putra Malaysia, Serdang, Selangor, Malaysia
 aimrun@upm.edu.my, rashidpls@upm.edu.my, ahmadfikri@upm.edu.my

Highlights: IPCA-RGB model is an image algorithm that was developed to improve fertilizer management of rice farming for precise fertilizer application. The algorithm was developed based on specific nutrients needs by rice plants according to their specific growth stages. The algorithm can be integrated with any type of surveillance drone for aerial image acquisition and can be suited with any ordinary RGB camera for aerial mapping procedure. The algorithm has 90% accuracy in determining precise fertilizer during field application at larger scales. Thus, the cost and amount of fertilizer application have successfully reduced up to 60% - 70% of saving.

Key words: rice farming, precision farming, fertilizer management, fertilizer algorithm, drone, aerial mapping.

Introduction

The concept of producing more with fewer inputs is a significant principle of Precision Farming (PF). PF focus on precise management in every aspect of farm variability including fertilizer management. In fact, PF highlights the importance of maintaining environmental quality whilst performing the farming activities without affecting the final production. However, PF is not cheap and requires a high cost to be implemented by the farmer. The high cost of PF and drone-based technology for field operation such as spraying and aerial mapping procedures become the main issue that hinders the wider adoption rate and acceptance among the rice farmer and service provider. For example, drone-based technology & accessories for aerial mapping procedures require high-end drones and specific cameras to perform the PF mapping technique. This makes service providers had to charges higher prices to the farmers to perform the PF procedure to cover their operation cost. Therefore, continuation research and collaborative effort from other researchers to improve further the available vegetation index & fertilizer calculation is necessary.

Innovation description

The main core of the innovation is perceived through the precise fertilizer algorithm calculation that is specifically developed according to the actual nitrogen requirement required by the rice plant based on various growth stages. The fertilizer algorithm calculation can be practiced with any type of rice planting system and even can be suited together either with the inorganic and organic type of fertilizer. The algorithm is called as IPCA-RGB which is mainly developed to enhance the fertilizer management of rice farming, especially for precise nitrogen fertilizer application (Abd. Kharim et al., 2019). The algorithm calculation is described below.

$$\text{IPCA-RGB algorithm} = 0.994 |R-B| + 0.961 |G-B| + 0.914 |G-R| \quad (\text{Saberioon et al., 2014}) \quad [1]$$

R = Red colour; B = Blue colour; G = Green colour

$$N \text{ (mg/L)} = 0.80 + 0.93 * \text{SPAD} \quad (\text{Gholizadeh et al., 2011}) \quad [2]$$

$$N \text{ (mg/L)} = -2.61 + 0.98 * \text{SPAD} \quad (\text{Gholizadeh et al., 2011}) \quad [3]$$

$$\text{Amount of liquid fertilizer (mL)} = [A - (C / 1000)] / D \quad (\text{Abd. Kharim et al., 2019}) \quad [4]$$

Where:

A = threshold level of N (mg/L) in the rice leaves

C = either [2] or [3] in N (mg/L)

D = N (%) of concentration rate of the liquid fertilizer used.

SPAD = SPAD values of rice leaves recorded from SPAD chlorophyll meter

Apart from that, the algorithm is specially made for the drone-based aerial image acquisition operation. The algorithm has been developed in simplified form so that any type of RGB camera either cheap or expensive one can be integrated with it. In fact, the default camera that already attaches to the drone can be used effectively to capture the aerial image of the rice field for a later precise fertilizer calculation process. The algorithm mainly helps to scan and determine precisely the actual nutrient (nitrogen) requirement needed by the rice plant based on the green colour and chlorophyll content of the rice canopy leaves. So that, precise fertilizer amount can be applied to the rice field through drone-based fertilizer spraying or granular broadcasting.

Innovation advantages & results

The IPCA-RGB algorithm has gone through a comparison study with the existing vegetation index model that available in the market to compare the reliability, accuracy, validity, and scalability of the algorithm within three years period of field experiments. From the comparison, the algorithm shows a positive result in determining nitrogen

content in rice plants for precise fertilizer application. Thus, the algorithm shows a higher close relationship with the chlorophyll and nitrogen content of the rice plant from the aerial image acquisition of the rice canopy leaf. In terms of yield performances, results showed that our IPCA-RGB algorithm had produced higher rice yields (ton/ha) for both types of fertilizer compared to other algorithms as shown in Figure 1.

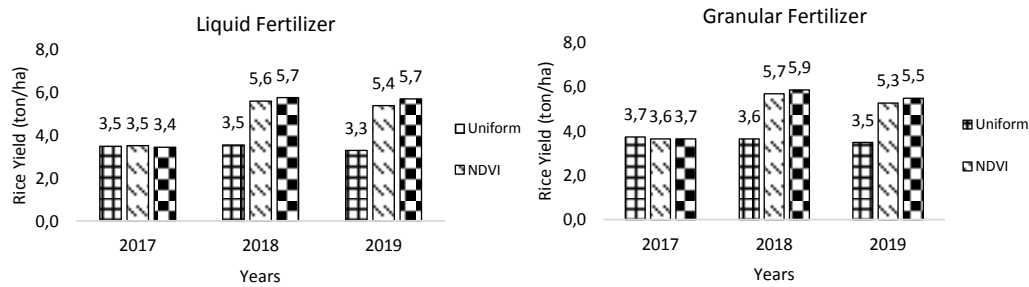

Figure 1 Comparison of rice yield (ton/ha) between different types of fertilizer algorithm for liquid and granular fertilizer during various years of field application

The innovation can help to reduce the overall cost of field operation especially the fertilizer input application in rice farming. As shown in Table 1, the cost comparison study shows that the I_{PCARGB} algorithm can help to reduce the fertilizer application cost by up to 60% - 70% of saving without affecting the final rice yield. This shows that the I_{PCARGB} algorithm can minimize the input cost for the fertilizing activities thus can help to reduce the overall cost of fertilizer management. Apart from that, the drone service provider can use the I_{PCARGB} algorithm within their post-analytic process to reduce the field operation cost since the algorithm can be integrated with any type of RGB camera that attaches to the drone for the aerial mapping procedure. The algorithm model can help to increase the accuracy of crop analysis in determining and calculate precisely the fertilizer amount that required to be applied to the field. Furthermore, with the current Artificial Intelligence and Machine Learning technology, the I_{PCARGB} algorithm can be integrated, improvise and improve further for smart and robotic fertilizer application within rice farming. The I_{PCARGB} algorithm just not limited for fertilizer management but it can be used to scan and detect the pest & disease infestation in the rice field for later mitigation procedures.

Table 1 Comparison of total fertilizer cost (RM)/ha between different types of fertilizer algorithm for both liquid and granular fertilizer application during various years

Type of fertilizer	Total Fertilizer Cost (RM)/ha					
	Liquid Fertilizer			Granular Fertilizer		
Algorithm	Uniform	NDVI	I_{PCARGB}	Uniform	NDVI	I_{PCARGB}
2017	48	19	15	640	192	184
2018	48	22	18	640	220	212
2019	48	20	15	640	216	210

Conclusion

Knowing actual nutrient requirements for rice plants is crucial in supplying the correct amount of fertilizer for better and precise fertilizer management in rice farming. I_{PCARGB} algorithm model can help to improve and reduce the cost of the aerial mapping procedure with a cheaper camera & drone. Thus, it can improve the accuracy of post-analytic for fertilizer mapping assessment. Moreover, the innovation can foster the adoption rate of drone-based technology among rice farmers towards precision farming activities and Industrial Revolution 4.0, especially in the Asia region.

Acknowledgement

The authors would like to acknowledge the Universiti Putra Malaysia for funding this research project under Putra Grant, project code GP-IPS/2017/9573700, SMART Farming Technology Research Centre, Faculty of Engineering, Universiti Putra Malaysia and Universiti Malaysia Kelantan for technical support.

References

- Gholizadeh, A., Amin, M.S.M., Anuar, A.R., Aimrun, W., & Saberioon, M.M. (2011). Temporal variability of SPAD chlorophyll meter readings and its relationship to total nitrogen in leaves within a Malaysian paddy field. *Australian Journal of Basic and Applied Sciences* 5(5): 236-245.
- Muhammad Nurfaiz Abd Kharim, Aimrun Wayayok, Abdul Rashid Mohamed Shariff & Ahmad Fikri Abdullah. (2019). Droplet deposition density of organic liquid fertilizer at low altitude UAV aerial spraying in rice cultivation. *Computers and Electronics in Agriculture* 167: 105045.
- Muhammad Nurfaiz Abd Kharim, Aimrun Wayayok, Abdul Rashid Mohamed Shariff, Ahmad Fikri Abdullah & Ezrin Mohd Husin. (2019). Preliminary study of variable rate application – organic liquid fertilizer by using SPAD chlorophyll meter on System of Rice Intensification (SRI) cultivation. *Communications in Soil Science and Plant Analysis* 50(5): 639-649.

BIODEGRADATION OF WASTE COOKING OIL, ORGANIC MATERIAL AND PLA-FILAMEN MIXTURE

Mohd Hafidzal Mohd Hanafi

Faculty of Mechanical Engineering, Universiti Teknikal Malaysia Melaka, Hang Tuah Jaya,
76100 Durian Tunggal, Melaka, Malaysia
hafidzal@utem.edu.my

Anis Ainaa Omar, Ainul Syakirah Md Saffie, Nurul Hanim Haji Razak, Asriana Ibrahim

Faculty of Mechanical Engineering, Universiti Teknikal Malaysia Melaka, Hang Tuah Jaya,
76100 Durian Tunggal, Melaka, Malaysia
asyakirah713@gmail.com, nurulhanim@utem.edu.my, asriana@utem.edu.my

Highlights: The aims of this study is to conduct biodegradation testing for five different samples. The samples involved in this biodegradation testing are Waste cooking oil (WCO) + Bee wax, WCO + Palm wax + PLA filament material, WCO + Bee wax + PLA filament material and WCO + Palm wax + PLA filament material. WCO is chosen in this study since WCO is among factors that contribute to the water pollution rate. Biodegradation testing is conducted by burying the sample in different duration of days (5, 10, 15 and 20 days). Blending of WCO + bee wax shows the highest biodegradation rates.

Key words: Waste cooking oil (WCO), Plastic, Biodegradation, Polymer, PLA, Bio-material

Introduction

Cooking oil and plastic are among products that very essential in daily life. Basically, cooking oils are used as a medium for during food preparation (Mukherjee, S and Mitra, A. 2009). During heating or frying, cooking oil is involved in chemical reactions, hydrolysis, oxidation and polymerization process (Mahendran, S et. Al. 2010). On the other hand, application of plastic increasing due to their extensive industrial and domestic applications. Currently, over 80% of the plastics used in the manufacturing sector are made from petroleum which making them non-renewable products. This has become a great threat to the environment (Rus, Salim & Sapiee, 2015). However, Improper waste cooking oil (WCO) and plastic disposal management is not only causes harmful to human kind, but also to environment and aquatic ecosystem. Waste cooking oil (WCO) is a sort of household waste created when edible vegetable oil is used to cook and fry food. WCOs have a chemical composition that includes triacylglycerols, glycerols, free fatty acids (FFAs), and a variety of polymerization chemicals. Plastic is an example of polymer. Generally, polymer used in the making of composites and plastics in its industry. Basically, it has hydrocarbon that contain of fluorine, chlorine, silicon, nitrogen and sulphur. Biodegradation of plastic take very long

In order to solve the problem created by WCO and plastic, an approach by reuse WCO and combine with organic material and Polyactic acid (PLA) to conduct biodegradation testing is conducted. The objective of this study is to investigate biodegradation testing for each samples. The final mass for each sample is measured to determine which sample have high rate of biodegradation.

Methodology

A biodegradation testing for five types of samples are conducted. The samples are WCO + Bee wax, WCO + Palm wax + PLA filament material, WCO + Bee wax + PLA filament material and WCO + Palm wax + PLA filament material. 200g of WCO is poured into the low form high borosilicate glass beaker chemistry container. The used cooking oil is heated on the multifunction mini household electric small stove cooker hot plate until the temperature reaches 50°C using digital food thermometer. Then, 200g of bee wax are added into the used cooking oil. The waste cooking oil is stirred continuously with a stirring rod until the hardener added into the borosilicate glass beaker have molten and mixed well with the waste cooking oil. The methods for all samples to make it solid are same as bee wax. The methods for all samples to make it solid are same. After all samples is become harder. Biodegradation test is started by burying the samples in different holes.

Five different holes were dig on a ground surface by using a hoe. A metal ruler was used to ensure that all the holes had the same depth equals to 10cm. Then, each samples are labelled by writing type of sample and number of buried days clearly. The number of buried days were 5, 10, 15 and 20 days. Each specimen is removed from underground after the listed days to measure the final mass of each model.

Results

Figure 1 shows the results of biodegradation testing for five different samples. Since the used types of organic waxes were difference, each specimen will have different biodegradability level. Experiment were carried out for 20 days to determine the changes of mass that took place in each specimen. Each specimen will be removed from the ground after each five days for weighing some mass will be lost. It can be seen that the 3D printer filaments (LB) – high quality PLA filament material has the lowest biodegradability level since the mass of this specimen remained constant at the throughout the 20 days of the experiment.

The mixture of waste cooking oil with bee wax specimen has a slightly lower mass after 20 days compared to the mixture of waste cooking oil with palm wax specimen. Therefore, the mixture of waste cooking oil with bee wax is more biodegradable.

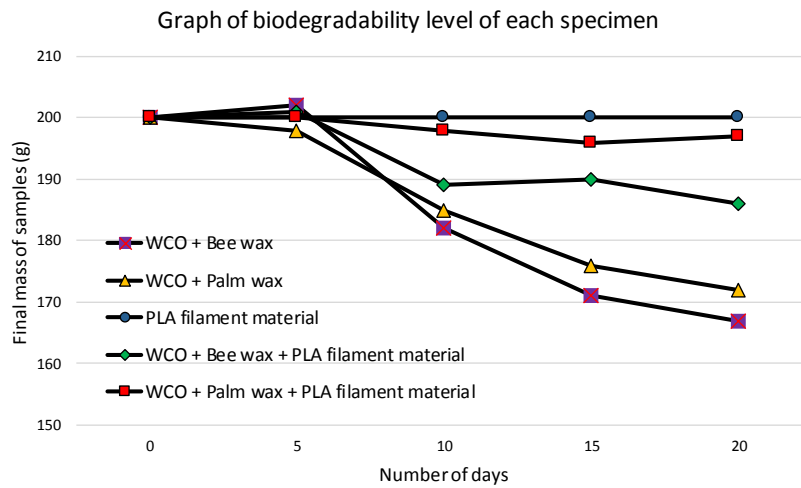

Figure 1 Result of biodegradation testing

Acknowledgement

Authors are grateful to Universiti Teknikal Malaysia Melaka (UTeM) for the financial support through FRGS/1/2020/FKM-CARE/F00436.

References

- Mahendran S., Devarajan R., Nagarajan T. and Majdi A. (2010). A review of micro-EDM. In: Proceedings of the international multi conference of engineers and computer scientists.
- Mukherjee, S and Mitra, A. (2009). Health effects of palm oil. *Journal of Human Ecology*. Vol. 26, pp.197-203.
- Rus, A. Z. M., Salim, N. S. M., & Sapiee, N. H. (2015). Recycling of cooking oil waste into reactive polyurethane for blending with thermoplastic polyethylene. *International Journal of Polymer Science*, 2015.

VSOL- INNOVATIVE METHOD TO DETERMINE ULTRA TRACE LEVELS OF PESTICIDES IN FRUITS

Krishna Veni Veloo

Universiti Malaysia Kelantan, Jeli, Kelantan, Malaysia
 veni.v@umk.edu.my

Highlights: VSOL is a new extraction kit of dispersive solid phase extraction, which comprises of new mesoporous hybrid material MTMOS-CPTES and a green extraction method for determination of organophosphorus pesticides in fruits and vegetable.

Key words: pesticides, dispersive solid phase extraction, green chemistry, microextraction

Introduction

VSOL is a new extraction kit of dispersive solid phase extraction, which comprises of new mesoporous hybrid material MTMOS-CPTES and a green extraction method for determination of organophosphorus pesticides in fruits and vegetable. It provides ultra-trace level detection capability for pesticides (part per trillion detection). VSOL uses 1 mL sample volume (10 times less sample volume compared to commercial sorbent material). Provide high extraction performances (high accuracy, sensitivity and precision). Acts as multi-modal sorbent (ability to extract wide range of analytes (non-polar to polar). Reusable up to 10 times, solves disposable problem. Eco-friendly and cost effective (15x cheaper than the commercial product).

Content

1. VSOL is a laboratory kit to detect level of pesticide in food and vegetables.
2. Commercial sorbent such as silica based materials, polymeric sorbents. However, they have limitations such as low recovery for analytes, Matrix effect, Low porosity material, Low sensitivity, Low precision (repeatability and reproducibility), Low reusability of sorbent material. Therefore, there is need new sorbent material to overcome these limitations. VSOL use sol-gel process to produce new sorbent material which exhibit high surface area, high porosity, high extraction efficiency, precision, sorbent reusability, able to overcome those limitations
3. VSOL uses 1 mL sample volume (10 times less sample volume compared to commercial sorbent material). Provide high extraction performances (high accuracy, sensitivity and precision). Acts as multi-modal sorbent (ability to extract wide range of analytes (non-polar to polar). Reusable up to 10 times, solves disposable problem. Eco-friendly and cost effective (15x cheaper than the commercial product).
4. The market for sample preparation kits is 2.28 million, this will go more as the need to ensure food safety

Table 1: Comparison of VSOL with commercial kit

OPPs	d μ SPE-MTMOS-CPTES (VSOL)				d μ SPE-PSA			
	Coefficient of determination (r ²)	RSD (%)	LOD (μ g/L)	LOQ (μ g/L)	Coefficient of determination (r ²)	RSD (%)	LOD (μ g/L)	LOD (μ g/L)
Chlorpyrifos	0.9999	2.5	0.0001	0.0040	0.9997	3	0.3	2
Diazinon	0.9998	2.6	0.0007	0.0028	0.9998	3.2	0.43	2.3
Profenofos	0.9996	1.5	0.0003	0.0010	0.9994	4	0.42	1.7
Quinalphos	0.9997	1.8	0.0006	0.0021	0.9995	2.5	0.33	2.1
Methidathion	0.9998	1.2	0.0009	0.0032	0.9997	3	0.3	2

Acknowledgement

The author acknowledge the Ministry of Higher Education Malaysia (MOHE) for financial support under the Fundamental Research Grant Scheme (FRGS).

References

Alessandra, A. J., O'Connor, M. J., & Van Dyke, J. (1994). People Smarts: Bending the Golden Rule to Give Others what They Want. Pfeiffer.

OLEOPHILIC POLYMER WASTE – OIL SOLIDIFIER (OPWOS) FOR USED COOKING OIL (UCO)

Nurul Hanim Razak

Centre of Advanced Research Energy (CARE), Universiti Teknikal Malaysia Melaka (UTeM), Melaka, Malaysia
nurulhanim@utem.edu.my

Mohd Hafidzal Mohd Hanafi, Asriana Ibrahim, Nurul Afwa Ab Razak, Norlina Mohamad Norani

Centre of Advanced Research Energy (CARE), Universiti Teknikal Malaysia Melaka (UTeM), Melaka, Malaysia
hafidzal@utem.edu.my. asriana@utem.edu.my. afwanisarazak@gmail.com. norlina764@gmail.com

Highlights: This paper presents a novel super adsorbent for used cooking oil, known as OPWOS. OPWOS includes oleophilic cellulose sorbent (corn cob, sawdust), NaOH, and hydrophobic polymers (PE and PP). The OPWOS is prepared through polymer blending; these blends are characterized and evaluated for their adsorption efficiency in used cooking oil solidification. OPWOS is made of plastic waste and super fibrous cellulose adsorbent with high oleophilic properties. This innovation helps in reducing fat, oil, and grease (FOG) down to drain, which can lead to sewer pipelines blockages and water pollution.

Key words: Fat, oil, and grease (FOG, used cooking oil (UCO), polymer waste, oleophilic, oil solidifier.

Why is it so important to properly dispose of FOG?

Fat, oil, and grease (FOG) is a by-product of cooking foods and includes vegetable oils, meats, dairy products, food scraps, meat fat, lard, tallow, cooking oil, butter, margarine, and sauces. Restaurants and other food premises are a significant source of FOG. FOG is usually found in kitchen wastewater causes severe problems during wastewater treatment. FOG causes major issues are contributing factors to sewer pipelines blockages and water pollution, costing municipalities millions in repairs every year. FOG induces the build-up of the fatberg, a congealed lump in a sewer system formed by the combination of non-biodegradable solid matter with grease or cooking fat. Continuous build-up of the fatberg will reduce the capacity of the sewer system and will ultimately cause blockages. These fat blockages can result in sewer flooding, dead fish, eutrophication, rotten smell, and the risk of rat infestations.

In addition, the clogged drains will also attract rodents and other pests that carry diseases. This blockage can result in an expensive plumbing repair bill to clean up the oil-clogged drains, as shown in **Figure 1**. FOG will coat the interior surface of the pipelines if it is discharged into the sewerage system directly. Over some time, it will harden and restrict wastewater while damaging the pipeline and polluting the environment. FOG is more difficult to degrade than other standard components of municipal sewage biologically. **Figure 2** depicts the tailor-made conceptual formulation of OPWOS from PP, PE, NaOH (lye), sawdust, and CC powder.

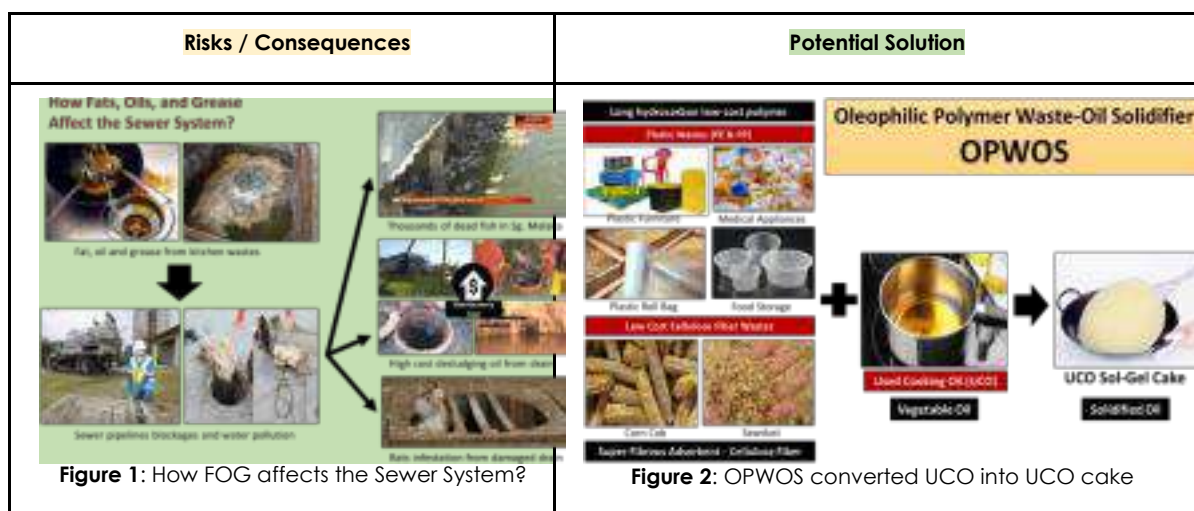

Teeming with food waste, clogged with grease and filled with water the color of curry, drains surrounding coffee shops and food stalls in most Kuala Lumpur and Selangor areas can be a nauseating sight. Alam Flora workers find it difficult to flush out the grease, slowed down by illegal pipes and other obstacles. In Malaysia, waste oil is classified as scheduled wastes under the First Schedule of the Environmental Quality (Scheduled Wastes) Regulations 2005 (doe.gov.my, 2010). The following codes and descriptions: Code SW 311- Waste oil or oily sludge. Waste oil should be appropriately managed according to the requirements of the Environmental Quality (Scheduled Wastes) Regulations 2005. The most effective solution is to ensure that FOG is stopped at the source and does not enter the wastewater system. After that, it should be removed before going down to the sink or drains.

Research Novelty and Objective

Limited study and attention are given in the literature on UCO solidification. There is no trace of research from the literature dealing with the polymer wastes to solidify UCO. The novelty of OPWOS is using low-cost feedstock and having a high adsorptive rate. This investigation aims to determine the effectiveness of oleophilic plastic waste and cellulosic fibrous sorbent to adsorb used cooking oil. In short, the oleophilic polymer waste-oil solidifier (OPWOS) contains plastic waste and super fibrous cellulose adsorbent with high oleophilic properties helps in oil solidification.

How can OPWOS help in UCO disposal and recycling plastic wastes?

This work aims to evaluate adsorption performance (%) of polyethylene (PE) and polypropylene (PP), NaOH, sawdust, and corn cob (CC) super absorbent to solidify used cooking oil. This solid UCO can be directly disposed of in a garbage bag. OPWOS also can help to solidify the UCO right after cooking. Hence, OPWOS significantly reduces the UCO down to the drain.

Analysis

Blends of PP, PE, NaOH (lye), sawdust and CC powder were prepared by mixing the corresponding amount of each of the polymers with UCO for a few minutes until a completely homogeneous solution was obtained. The optimally prepared adsorbents from OPWOS blends were further evaluated. The analysis focuses on the total time taken for the UCO to become UCO Sol-Gel Cakes.

Results and Discussion

OPWOS solidifiers are polymers that have a physical attraction to UCO enhanced by van der Waals forces, based on the theory that molecules are attracted to those with similar structures. Nonpolar hydrocarbon polymers (sawdust and CC) are attracted to nonpolar petroleum hydrocarbons (PP, PE). NaOH is the catalyst to escalate the solidification process. They consist of long hydrocarbons with a loose molecular structure and fibrous (Chandrasekhara Rao, P., 2020). The resulting data are tabulated in Table 1.

Table 1: Parameters

Blends of Oleophilic Polymer Waste – Oil Solidifier (OPWOS)			Time Taken to Solidify UCO (min)
Plastic Wastes	Cellulose Adsorbent Wastes		
PE, PP (mg)	<i>Constants: Corn cob, sawdust, NaOH</i>		
0	UCO	200 mL	0
100	NaOH	100 mL	5
200	Sawdust	100 mg	10
300	Corn Cob	100 mg	15

The OPWOS (absorbent) will dissolve in UCO (adsorbate), thicken the UCO, increase its viscosity, and eventually form a UCO Sol Gel Cake. The high oil uptake of the OPWOS is mainly due to the presence of pores and voids in the absorbent OPWOS structure. The grain size and surface area primarily control the reaction time of the sorbents. The extent of intermolecular forces between adsorbate UCO and the absorbent OPWOS proliferate the adsorptive effects. Intermolecular forces depend on two features of molecular structure. Firstly, the forces increase as the molecular weight/chain increases. Secondly, intermolecular forces depend upon molecular shape via the surface area over which two molecules can contact (Inaqbi, M., Al Blooshi, A., & Greish, Y., 2020). The diagram in Figure 3 concluded that the higher the polymer plastic, the faster the time taken to solidify the UCO, the harder the oil cake.

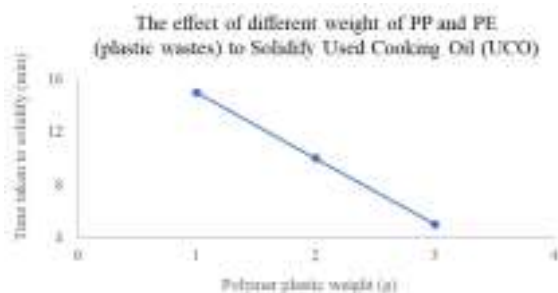

Figure 3: The effect of plastic wastes on used cooking oil solidification

Conclusion

The blends of a hydrophobic polymer plastic waste and oleophilic super fibrous cellulose show a high affinity for oil solidification. The resulted OPWOS in UCO concluded that the higher the weight of polymer plastic, the faster the time taken to solidify the UCO, the harder the oil cake. This is because the plastic waste blended with cellulose fibrous adsorbents provides higher pores and voids in the absorbent OPWOS structure. The future idea of OPWOS is highly recommended for the high-rise residential to manage their UCO easily by converting the UCO to UCO sol-gel cake, hence, avoiding the domestic oil spill and clogging the drains.

Acknowledgement

We are grateful for the xyz. The authors would like to thank Universiti Teknikal Malaysia Melaka (UTeM) for providing a research fund under research grant number: FRGS/1/2020/FKM- CARE/F00436.

References

- Inaqbi, M., Al Blooshi, A., & Greish, Y. (2020). Polyethylene and Polyvinyl Chloride-Blended Polystyrene Nanofibrous Sorbents and Their Application in the Removal of Various Oil Spills. *Advances In Polymer Technology*, 2020, 1-12.
- Chandrasekhara Rao, P. (2020). Effects of matrix modification on mechanical and durability characteristics of polymer composites through variations in micro fillers, macro fillers, and fibers. *Construction and Building Materials*, 235, 117505.
- doe.gov.my, 2010. Guidelines on Standard and Specification of Recovered Waste Oil in Malaysia. <http://www.doe.gov.my/>. <http://www.doe.gov.my/> (accessed July 2 2021).

BOTANICAL REPELLENTS AGAINST SNAIL (*ACHATINA FULICA*)

Tengku Halimatun Sa'adiyah Binti T Abu Bakar,
Faculty Agro Based Industry, Universiti Malaysia Kelantan
halimatun@umk.edu.my

**Ainon Najihah Binti Abd Rahman, Jeffrey Anak Tasek, Tengku Halimatun Sa'adiyah Binti T Abu Bakar,
Suhana Binti Zakaria, Maryana Binti Mohamad Nor, Norhafizah Md Zin & Raja Ili Airina Raja Khalif**
Faculty Agro-Based Industry, Universiti Malaysia Kelantan
halimatun@umk.edu.my, suhana@umk.edu.my, norhafizah.mz@umk.edu.my, norhafizah.mz@umk.edu.my

Highlights: Nowadays, there is a lot of synthetic pesticides and repellent for the snails (*Achatina fulica*) produced by the industry that may cause negative effect on human and environment. Thus, this innovation used botanical plants which are ginger (*Zingiber officinale*), and coffee as a repellent for the snails. Finding showed ginger & coffee were effective as botanical repellent against snails (*Achatina fulica*) as there is significant on weight loss of crops, mortality & survival rate. Thus, this innovation focused on the efficiency of botanical repellent by mixed ginger and ground coffee against snails. In general, the creation of ginger, and coffee as a botanical repellent for snails has improved the farming environment and helped in cultivating quality and eco-friendly crops.

Key words: Botanical repellent, *Achatina fulica*, *Zingiber officinale*, *Allium sativum*, Coffee

Introduction

Agriculture has become one of the most important sectors to produce food for a human being. It remains an important sector in Malaysia and becomes the backbone of the Malaysian economy by producing agricultural products for domestic consumption. According to the official portal of the Department of Statistics Malaysia (2019), the agriculture sector contributed 7.3 percent (RM99.5 billion) to the Gross Domestic Product (GDP) in 2018 (Mahidin, 2019). Nowadays, the development of the agriculture sector has led farmers to use chemical products to control and prevent various types of agriculture pest attacks. However, the problem that arises is that the chemical pesticides have caused the pest to evolve and become resistant to the pesticides even though a huge concentration of pesticide is being used (Hawkins, et al., 2018). The same pesticide can no longer be used to control and prevent the pest population on the farm. Besides, the problem that rises from the use of pesticides is due to chemical waste which not only affects the environment but also a human beings. The management of all pesticides and other chemicals used in Agriculture was covered under this Act. Other related regulations on the management of pesticides are the Food Act 1983 and Environment Quality Act 1974 (Jiang, 2017). Furthermore, many commercial farmers take the easy way by using the pesticides in excess to quickly eliminate the pests. Even though it can increase the productivity of the crops but it will have an impact on health (Ali & Shaari, 2015).

The insecticidal properties of the number of plants have been discovered long years ago (Chaudhari, 2014). These plant-derived pesticides are bio-degradable and environmentally friendly. These botanical pesticides help in producing non-toxic, safe, and healthy food crops. Besides, botanical pesticides also help to conserve natural resources and are easily decomposed. People often think that the term a pesticide usually refers to something that kills insects. However, the pesticide has a broad term that includes products that do not kill the insect such as repellent (Environmental Protection Agency, 2019). The use of botanical pesticides helps to maintain the beneficial insect and pest population in the fields (Abhishek, 2018). Also, they reduce the farmer's dependency on conventional chemical pesticides. United Nations (UN) reported that an average of about 200 000 people dies each year across the world due to pesticide poisoning. UN also reported that pesticide poisoning even exceeds fatalities from infectious diseases in some countries (Rifal, 2017). Since 2017, organic pesticides have dominated the market due to the rising awareness regarding the benefits of organic pesticides (Abhishek, 2018). Besides, the previous study has shown that garlic, ginger, and the ground coffee show can be used as a repellent against snails. A study had reported that garlic extract has toxic effects against gastropods (Anwar et al., 2017). A study by Capinera (2018) also claiming the effectiveness of garlic extract against gastropods including snails. The study by Kumar et al., (2018) reported that ginger can repel snail and slug. The result from a study by Rosli (2017) shows that coffee is one of the most effective repellents against snails as it took the fastest time to repel. This innovation focused on the efficiency of botanical repellent by using garlic, ginger, and coffee against snails. In general, the creation of ginger, and coffee as a botanical repellent for snails has improved the farming environment and helped in cultivating quality and eco-friendly crops.

Content

This innovation focused on the efficiency of botanical repellent by mixed ginger and coffee against snails. However, one experiment has been done to observe the efficacy of botanical plants which are ginger (*Zingiber officinale*), garlic (*Allium sativum*), and coffee as a repellent for the snails. Spinach (*Spinacia oleracea*) was used as a food source for the snails as it contains more calcium which is needed for shell formation compare to other vegetables. The extract of the solution is done by blending the ginger rhizome (T1) and garlic bulb (T2) with water separately for

each treatment. The coffee solution (T3) was extracted by brewing the coffee grounds with hot water. Mixed treatment (T4) was done by mixing ginger, garlic, and coffee solutions. Isolation of the land snail was done before the experiment began. The parameters that have been observed in this study were fresh weight loss of the spinach, mortality, and survival of the snails. Fresh weight loss of the spinach, mortality, and survival of the snails will be observed every three days. The plants extract treatments had been compared with the control treatment (T0). Findings showed ginger & coffee were effective as a botanical repellent against snails (*Achatina fulica*) as it is significant on weight loss of crops (Figure 1), mortality (Figure 2) & survival rate (Figure 2). Thus this study focus on producing botanical repellent product mix ginger & coffee ground.

Botanical repellents are a natural product based on mixed ginger (*Zingiber officinale*) and ground coffee that help against Snail (*Achatina fulica*). This product is a botanical product that is free of chemicals and safe for humans, plants, and the environment. Moreover, these botanical repellents have huge potential to be commercialized and enter natural ingredient insect repellent because nowadays, the global natural ingredient insect repellent market size is projected to reach USD 1718.2 million by 2026, from USD 1391.9 million in 2021 (Future Marketing Insight, 2021). Besides, currently, there is the potential of the seller and distribution from Sestra High Enterprise and The Hobbit GardenNursery which is a student company Universiti Malaysia Kelantan.

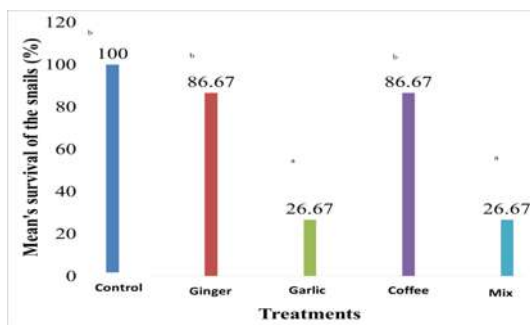
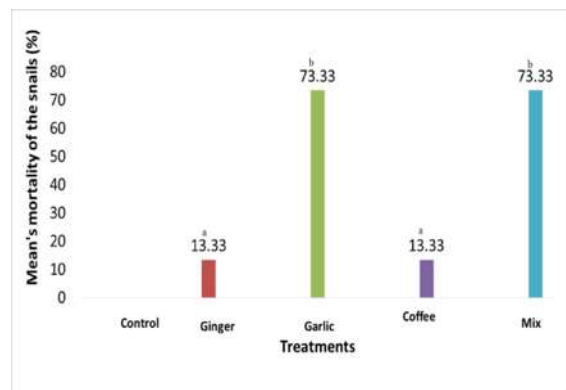
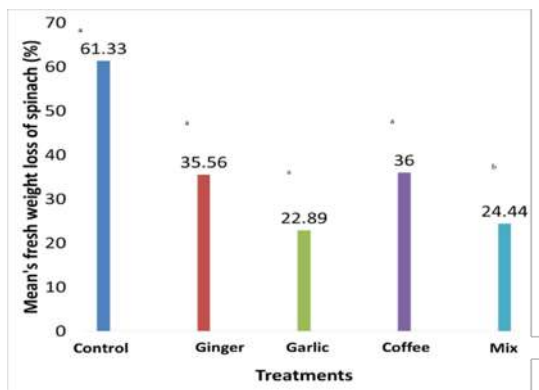

Figure 3. Mean's f survival of the snail spinach

Figure 4. Treatments done in this study with three replication for each (T0=control, T1=ginger, T2=garlic, T3=coffee, T4=mix).



Figure 5. Botanical repellent with new packaging

Acknowledgment

The authors wish to thank Universiti Malaysia Kelantan for supporting the present research. This research is supported by Universiti Malaysia Kelantan and Ministry of Finance (MOF) under UMK-MOF Social Enterprise Project (R/MOF/A0700/01283A/2020/00730).

References

- Abhishek, S. (2018, December 21). Organic Pesticides Market 2019 Industry Analysis, Size, Share, Application, Trends, Overview – Forecast to 2023. Retrieved March 25, 2020 from Market watch: <https://www.marketwatch.com/press-release/organic-pesticides-market-2019-industry-analysis-size-share-application-trends-overview-forecast-to-2023-2018-12-21>
- Ali, A., & Shaari, N. (2015). Mismanagement of Chemical Agriculture in Malaysia from Legal Perspective. *Procedia Economics and Finance*, 31, 640-650.
- Anwar, A., Gould, E., Tinson, R., Groom, M., & Hamilton, C. J. (2017). Think yellow and keep green—role of sulfanes from garlic in agriculture. *Antioxidants*, 6(1), 3.
- Capinera, J. (2018). Assessment of barrier materials to protect plants from Florida leatherleaf slug (Mollusca: Gastropoda: Veronicellidae). *Florida Entomologist*, 101(3), 373-382.
- Chaudhari, S. V. (2014). Management of insect pest by using herbal plants extracts. *Journal of International Academic Research for Multidisciplinary*, 2, 453-459.
- Environmental Protection Agency, (2019, August 9). What is an Insect Repellent? Retrieved 27, August, 2020 from United States Environmental Protection Agency: <https://www.epa.gov/insect-repellents/what-insect-repellent#:~:text=%E2%80%8BPeople%20often%20think%20of,not%20designed%20to%20eliminate%20pests.>
- Future Marketing Insight (2021). Natural Insect Repellent Market. Retrieve on 18 July 2021 from <https://www.futuremarketinsights.com/reports/natural-ingredient-insect-repellent-market>
- Hawkins, N. J., Bass, C., Dixon, A., & Neve, P. (2019). The evolutionary origins of pesticide resistance. *Biological Reviews*, 94(4), 135-155.
- Jiang, S. (2017). Overview of Pesticide Management in Malaysia. Retrieved May 2, 2020 from Agrochemical ChemLinked: <https://agrochemical.chemlinked.com/chempedia/overview-pesticide-managment-malaysia>
- Kumar, E. S., Vieira, M., & Doyle, C. (2018). Identification of Plant Extracts and Oils as Insect Repellents. *BEMS reports*, 4(2), 23-30
- Mahidin, D. S. (2019). Selected Agricultural Indicators, Malaysia, 2019. Retrieved March 13, 2020 from Department of Statistics Malaysia, Official Portal: https://www.dosm.gov.my/v1/index.php?r=column/cthemeByCat&cat=72&bul_id=SEUxMEE3VfDfBcDjhdUhpZVUxa2pKdz09&menu_id=Z0VTZGU1UHBUT1VJMfpaXRRR0xpdz09
- Rifal, R. (2017). UN: 200,000 die each year from pesticide poisoning. Retrieved April 9, 2020 from Aljazeera: <https://www.aljazeera.com/news/2017/03/200000-die-year-pesticide-poisoning-170308140641105.html>
- Rosli, N. I. (2017). Studies on The effect of organic repellents towards achatina sp. B. Sc. Thesis. Universiti Teknologi Mara.

MULBERRY LEAVES CHIPS

Tengku Halimatun Sa'adiyah Binti T Abu Bakar
Faculty Agro-Based Industry, Universiti Malaysia Kelantan
halimatun@umk.edu.my

**Mohamad Syahid Farhan Bin Mohd Zaki, Nurul Hasanah Binti Ibrahim, Hanis Syazwani Binti Haron,
Mohamad Nabil Bin Razali, Maryana Mohamad Nor, Suhana Zakaria & Siti Nuurul Huda Binti
Mohammad Azmin**

Faculty Agro Based Industry, Universiti Malaysia Kelantan
syahid.f18a0062@siswa.umk.edu.my, hasanah.f18a0286@siswa.umk.edu.my, hanis.f18b0036@siswa.umk.edu.my,
nabil.f18a0059@siswa.umk.edu.my, maryana.mn@umk.edu.my, suhana@umk.edu.my, huda.ma@umk.edu.my

Highlights: The use of mulberry leaves as human food is still not aggressively commercialized although mulberry leaves have many advantages. Mulberry leaf chips are alternative product innovations that can add value to the snack market for healthier products. The results showed that the mulberry leaves chips exhibited the optimum physical properties with the highest degree of puffiness and desirable moisture content, colour, and textural properties. Consumer preference test showed that mulberry leaves chips earned the highest scores in appearance, colour, crispness, taste, and willingness to buy. The development of novel mulberry leaves products will increase the economic value of mulberry leaves by producing healthier & Functional Food by underutilized parts of the mulberry plant.

Keywords: *Mulberry leaves, vegetable chips*

Introduction

The mulberry tree is an aromatic berry that is normally used as a superfood due to its high vitamins, minerals, and plant compounds. Recently, there are massive researches on the use of different parts of the mulberry tree in producing value-added food products. However, the utilization of mulberry leaves as human food ingredients still lacking (Larasati & Issutarti, 2017) and identity at the commercial scale of the mulberry tree is still poor (Dhiman et al., 2020). Mulberry leaves have many advantages and have a very strong antioxidant effect (Frank & Orwell, 2013). Normally, mulberry leaves were used for animal feed because palatable to animals and high nutritious (Sánchez-Salcedo et al., 2017). Moreover, mulberry leaves are also suitable for human food due to contain carbohydrates, protein, calcium, vitamin, folic acid, iron, ascorbic acid, and, non – toxic (Charunuch et al., 2007). Mulberry leaves are also rich in flavonoids and moracins that affect as a free radical scavenger or antioxidant (Sharma et al., 2001). Moreover, mulberry leaves have huge potential to enter the food market due to their bioactive compounds and health benefits attributed (Dhiman et al., 2020). Alternative innovation based on underutilize parts of mulberry such as mulberry leaves tree will increase the economic value of mulberry tree (Larasati & Issutarti, 2017), especially as a healthier snack. A line with the change of people's demand and lifestyles for convenient and healthy foods helps to boost the snack market (Thunyanichnondh et al., 2020).

Content

Mulberry leaves chips are a healthier snack that contains high nutrients and antioxidants. Blended mulberry leaves were mixed with cornflour and the chicken flavor was prepared for snack food production. The mulberry leaves chips were examined for physical characteristics (puffiness, moisture content, color, and texture). Besides, consumer preference test of mulberry leaves chips also have evaluated using an untrained panel (n = 50) includes appearance, color, crispness, taste, and willingness to buy. The consumer preference test in this research uses five-item Likert scale, that is 1 = does not like, 2 = rather dislike, 3 = normal, 4 = rather like, 5 = likes. Based on Table 1, mulberry leaves chips have the highest degree of puffiness and desirable moisture content, color, and textural properties. Appearance, color, crispness, taste, and willingness to buy are considered important attributes by the consumer for snacks or chips. Based on the consumer preference test (Table 2), the majority of respondents liked mulberry leaf chips and were willing to buy them. Most of the respondents like mulberry appearance (48%), color (47%), crispness (48%), and taste (44%) even though few respondents dislike color (5%) and crispness (2%) mulberry leaves chips.

Mulberry leaves chips are a healthier snack because rich in high vitamins, minerals, and antioxidants. This product is also free from chemical floor, artificial color, and preservatives. Moreover, mulberry leaves chips to have huge potential to be commercialized and enter the snack market because based on market data forecast (2021), the size of the global Healthy Snacks Market is worth the US \$ 23.05 billion in 2021, and is estimated to reach a valuation of US \$ 32.88 billion by the end of 2026. Besides, currently, there is the potential of the seller and distribution from LaFruta Fresh enterprise which is student company Universiti Malaysia Kelantan.

Table 1: Physical attributes of mulberry chips

L*, a*, b* :colour codes; BI: browning index, P_i : degree of puffiness.

Table 2. The Results of Consumer Preference Test

Moisture (%)	L*	a*	b*	BI	P _i (%)	Factorability (g)	Hardness (g)	
6.9±0.2	79.5±0.6	-9.8 ±1.0	-5.1±1.2	-18.9 ±0.4	750 ±106	859 ±368	1077 ±132	
ATTRIBUTE		PERCENTAGE (%)						
	1	2	3	4	5			
Appearance	0	0	15%	37%	48%			
Color	0	5%	12%	36%	47%			
Crispness	0	2%	22%	28%	48%			
Taste	0	0	14%	42%	44%			
Willingness to buy	0	2%	18%	32%	48%			

* 1 = does not like, 2 = rather dislike, 3 = normal, 4 = rather like, 5 = likes.



Figure 1. Mulberry leaves Chip



Figure 2. Mulberry leaves Chip with new packaging

Acknowledgment

The authors wish to thank Universiti Malaysia Kelantan for supporting the present research. This research is supported by Universiti Malaysia Kelantan and the Ministry of Finance (MOF) under the UMK-MOF Social Enterprise Project grant (R/MOF/A0700/01283A/2020/00730).

References

- Charunuch, C., Tangkanakul, P., Rungchang, S., & Sonted, V. (2007, January). Application of mulberry (*Morus alba*) for supplementing antioxidant activity in extruded Thai rice snack. In *International Workshop on Medicinal and Aromatic Plants 786* (pp. 137-146).
- Dhiman, S., Kumar, V., Mehta, C. M., Gat, Y., & Kaur, S. (2020). Bioactive compounds, health benefits and utilisation of *Morus* spp.–a comprehensive review. *The Journal of Horticultural Science and Biotechnology*, 95(1), 8-18.
- Larasati, A., & Issutarti, I. (2017, October). The Analysis of Consumer Preferences on Mulberry Leaves Tea as An Antioxidant-Enriched Product. In *2nd International Conference on Accounting, Management, and Economics 2017 (ICAME 2017)* (pp. 41-51). Atlantis Press.
- Sánchez-Salcedo, E. M., Amorós, A., Hernández, F., & Martínez, J. J. (2017). Physicochemical properties of white (*Morus alba*) and black (*Morus nigra*) mulberry leaves, a new food supplement. *J. Food Nutr. Res*, 5, 253-261.
- Sharma, R., Sharma, A., Shono, T., Takasugi, M., Shirata, A., Fujimura, T., & MACHII, H. (2001). Mulberry moracins: scavengers of UV stress-generated free radicals. *Bioscience, biotechnology, and biochemistry*, 65(6), 1402-1405.
- Thunyanichnonndh, J., Suebsiri, N., Leartamonchaikul, S., Pimolsri, W., Jittanit, W., & Charoensiddhi, S. (2020). Potential of green seaweed *Ulva rigida* in Thailand for healthy snacks. *Journal of Fisheries and Environment*, 44(1), 29-39.

SMART CHAMBER FOR PRE-ACCLIMATIZED TISSUE CULTURE BANANA PLANTLETS

Suhana Zakaria

¹Faculty of Agro based Industry, Universiti Malaysia Kelantan, Jeli Campus, 17700 Jeli, Kelantan, Malaysia
suhana@umk.edu.my

**Tengku Halimatun Saa'diah T Abu Bakar¹, Maryana Mohamad Nor^{1,2}, Fatimah Kayat²
Raja Ili Airina Raja Khalif¹, Muhammad Irfan Hakim Azmi¹**

¹Faculty of Agro based Industry, Universiti Malaysia Kelantan, Jeli Campus, 17700 Jeli, Kelantan, Malaysia

²Institute of Food Security and Sustainable Agriculture (IFSSA), Universiti Malaysia Kelantan,
Jeli Campus, 17700 Jeli, Kelantan, Malaysia

halimatun@umk.edu.my; maryana.mn@umk.edu.my; fatimah@umk.edu.my; airina@umk.edu.my;
muhamadirfan356@gmail.com

Highlights: Smart Chamber was developed for pre-acclimatization of tissue culture banana plantlet. This chamber was equipped with ventilation fan, temperature and humidity sensor, and misting system that linked with Xiami software to control the humidity and temperature inside the chamber. The pre-acclimatize banana plantlets were transferred in the planting tray and left for 2 weeks before transfer in the polybag. The chamber help the plantlet to grow healthy and decrease the percentage of dry and wilt plantlet.

Key words: tissue culture, acclimatization, chamber, banana, humidity, temperature

Introduction

Banana tissue culture seedlings have high demand from farmers. However, during the pre-acclimatization process that is when tissue culture banana plantlets are transferred from the jar (in vitro) to the nursery (ex vitro), only 80-90% of tissue culture plantlets are alive and the rest will die. The mortality factor is caused because the plantlets are very sensitive and unable to adapt to the outdoor environment which has inconsistency of temperature and humidity. This smart chamber was introduced to help the farmers to pre-acclimatize tissue culture banana plantlets to slowly adapt to the real environment after being taken out from the lab. The ex-lab plantlets were very sensitive, thus needing a condition that can reduce the mortality of the plantlets. The objective of this study was to develop a smart chamber equipped with a ventilation, irrigation system and a remotely controlled humidity and temperature detector to place ex-lab tissue culture banana plantlets.

Description of product development

A chamber with a size of 15 feet long, 15 feet wide and 9 feet high (15 '(P) X 15' (L) X 9 '(T)) was built as a place/space for the pre-hardening process equipped with an irrigation system, ventilation as well as temperature/humidity detectors (Figure 1). The misting irrigation system was set up to operate twice a day at 8 am and 6pm. This misting system also was set up to automatically turn on when the temperature/ humidity sensor increased more than 40oC and low humidity was less than 50%. Two ventilators were equipped to make sure the ventilation inside the chamber is in good condition.

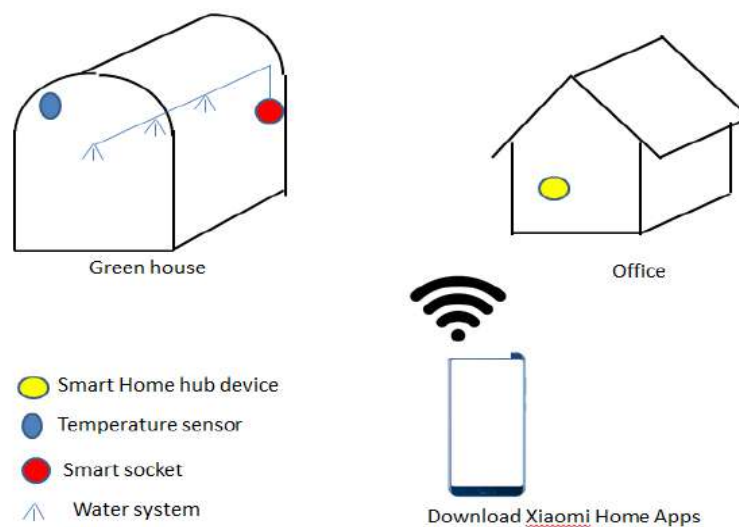

Figure 1. Smart Chamber

Tissue culture banana plantlets were placed inside the chamber to investigate the effectiveness of the developed smart chamber. The plantlets placed in the chamber had an average height increase of 0.58cm compared to the control of 0.45cm in height during the 2 -week monitoring period. The average increase in the number of leaves was 0.58 for plantlets placed in the smart chamber, while the control was only 0.1 in number. In terms of color, the leaves of the plantlets have been classified into 3 colors, namely green which indicates a fresh tree, yellow which indicates a less fresh tree and brown which indicates that the tree is almost dead. The data from this project showed that 90% of the leaves of the control trees were green in week-1 but decreased to 40% during week 2. The yellow color increased from 10% to 50% and there were 10% showing a brown color which is a sign of an unhealthy and almost dead tree. For leaves placed in the smart chamber, 88.9% were green in week-1 and decreased slightly to 84.44% in week 2. Overall, the green leaves in the chamber were 86.67%, yellow 13.33% and none brown. This clearly indicates that no tree death occurs if the tree is placed in a controlled condition.

Importance towards education, community and farmers

This smart chamber can be used to reduce mortality of in vitro banana plantlets and produce high productivity of survival plantlets. Besides, this system can reduce manpower to operate irrigation systems and the system can be monitored by smartphone. It will save time, cost, manpower and also save plantlets from die. At the same time, integration of technology in agriculture can attract the younger generation to join and work in this field.

Commercial value in terms of marketability or profitability

This smart chamber has a potential to be commercialized with the suitable specification required.

Acknowledgement

The authors wish to thank financial support from the Ministry of Education for the PPRN grant, Universiti Malaysia Kelantan and Emas Impresif Sdn Bhd for technical support contributed in this study.

References

- Chandra S., Bandopadhyay R., Kumar V. & Chandra R. (2010). Acclimatization of tissue cultured plantlets: from laboratory to land. *Biotechnol Lett* 32:1199–1205
- Vasane S. R. & Kothari R. M. (2006). Optimization of secondary hardening process of banana plantlets (*Musa paradisiaca* L. var. grand nain). *Indian Journal of Biotechnology* 5, 394-399

SCREENING AND TRIAGE CUBICLE (S.A.T CUBE) FOR COVID-19

Mhd Hafiz Karami Mhd Zain

Universiti Malaysia Kelantan, Bachok, Malaysia
 hafiz.k@umk.edu.my

Wan Azlina Wan Ismail¹, Najah Md Alwi¹, Norwina Mohd Nawawi², Wan Pauzi Wan Ibrahim³, Azirawati Ismail⁴, Mohd Zurairie Mohd Zubir⁵

¹Universiti Malaysia Kelantan, Bachok, Malaysia, ²International Islamic University of Malaysia, Kuala Lumpur, Malaysia, ³Universiti Sultan Zainal Abidin, Kuala Terengganu, Malaysia, ⁴Hospital Raja Perempuan Zainab II, Kota Bharu, Malaysia, ⁵Bulan Sabit Merah Negeri Kelantan, Kota Bharu, Malaysia
 azlina@umk.edu.my, najah.ma@umk.edu.my, norwina@iium.edu.my, wanpauzi@unisza.edu.my, geera82@gmail.com, zurairiezubir@gmail.com

Highlights: The SAT Cube is an idea borne out of a need to assist and provide a safe and convenient space for health care personal during screening and triage phase of the patients suspected of COVID-19. It is also designed in consideration of any future similar air-borne pandemic predicted by scientists.

Key words: Covid-19 Screening Booth, Healthcare, virus isolation room, ergonomic, anthropometric, pandemic

Introduction

When the Coronavirus Disease 2019 (COVID-19) pandemic occurred worldwide in March 2020, it has intensified global health care institutions to execute screening methods to identify the virus, along with means to contain the spread. While there is still ongoing research to learn about the variants of COVID-19, the screening protocols remain the same. Until now, studies have shown that the spreadability of COVID-19 share similarities with other coronaviruses, infecting primarily from person to person via respiratory droplets among close contacts under a specific period. Therefore, the healthcare personnel, especially doctors and nurses, as the first defences of the front lines of caring for patients with possible or confirmed infection with COVID-19, have an increased risk of exposure to this virus every day in the field.

As the cases of COVID-19 in Malaysia continues to rise, a large number of daily COVID-19 screening continues nationwide. However, the combination of local climate, paired with extended hours working in personal protective equipment (PPE) suits, has resulted in extensive mental and physical exhaustion reported among healthcare workers. In addition, the hospitals were also facing other issues with medical supplies shortage in the personal protective equipment (PPE) suits.

Was there a way to accommodate safer screening space for doctor and nurse to reduce this risk during screening? What is the feasibility of designing a portable "cleanroom" that reduces the PPE use inside the cube? These are just the early driving questions that researchers from University Malaysia Kelantan to collaborate with several local health facility experts in assisting the aforementioned issues. In this proposal, the product development strategies are presented.

S.A.T. Cube Design Strategies

The S.A.T Cube has specific functionality aims in which it plans to achieve with the following objectives:

Table 1: Aims and approaches

Objectives	Design Strategies
To provide safer space for doctors/nurse/healthcare personnel to conduct screening test for COVID-19	S.A.T Covid designed with enclosed space for health personnel with waterproofed wall and indoor circulated air conditioned.
To provide safe platform and isolation between doctor and patient to conduct swab test	1. Half transparent wall designed slanted at suitable angle with 2 holes wrapped with long plastic gloves to make doctor easier to reach seated patient while conducting the swab test 2. Both sided are provided desk to put the related documents and equipment 3. Space for patient are covered with overhanded roof which also as cover to close the counter from outside.
To avoid test sample exposed to health personnel and the other patient during the swab test	S.A.T Cube has a 'tunnel' at the middle of the cube which allows the test sample to be insert will be insert into a small 'window' attached to patient counter to bring it to the back of the booth by sliding through roller inside the tunnel. This strategy is to avoid health personal exposed to the positive COVID-19 patient at the front counter so they can collect the sample from the behind of the cube.
To create a portable outdoor screening test cube	This cube designed to be light weight by using aluminium panel as the structure and acrylic panel as the walls so it can be use outdoor and easily can be remove to any suitable outdoor place.
To create an affordable screening test cube	The structure, wall and electrical dan mechanical fitting of the cube are

design using affordable material.

The figure below shows the spatial organisation, the sampling operational and the design of the S.A.T Cube:

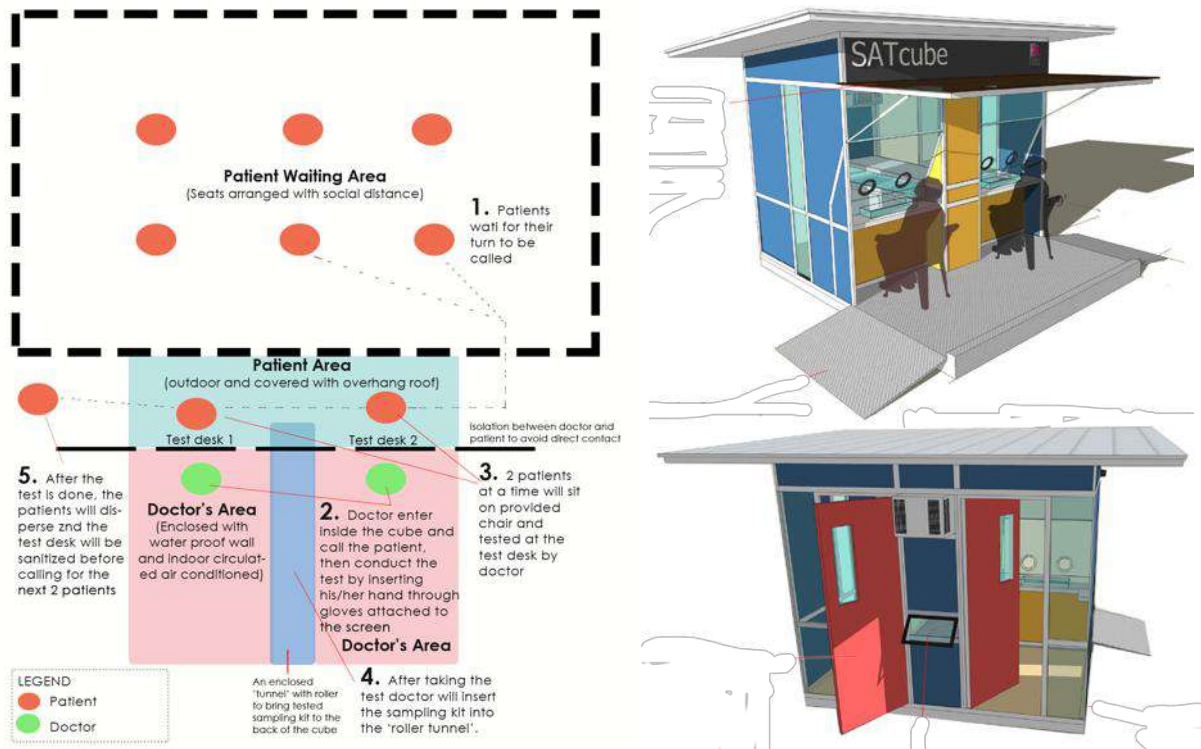

Figure 1: Spatial organisation, the sampling operational and the outer look of the S.A.T Cube

To conclude, the S.A.T Cube is still in its early the design phase and is planned for further development toward a buildable prototype. The potential of this product design lies in its purpose to alleviate the physical burden of donning long hours of PPE suits which health workers when larger quantity of COVID 19 screenings take place. Subsequently, the cube can also be commercialised for further custom design features that would be of use to interested institutional parties.

Acknowledgement

We would like to express acknowledgement to the team, the health and medical facility experts from Universiti Sultan Zainal Abidin, International Islamic University of Malaysia and Hospital Raja Perempuan Zainab II, as well as the Healthcare NGO Bulan Sabit Merah Negeri Kelantan who contributed as a mediator for this project.

References

- Carayon, P., Xie, A., & Kianfar, S. (2014). Human factors and ergonomics as a patient safety practice. *BMJ quality & safety*, 23(3), 196–205. <https://doi.org/10.1136/bmjqs-2013-001812>
- Ong SWX, Tan YK, Chia PY, et al. Air, Surface Environmental, and Personal Protective Equipment Contamination by Severe Acute Respiratory Syndrome Coronavirus 2 (SARS-CoV-2) From a Symptomatic Patient. *JAMA*. Published online March 04, 2020. doi:10.1001/jama.2020.3227
- Chowell G, Abdirizak F, Lee S, et al. Transmission characteristics of MERS and SARS in the healthcare setting; a comparative study. *BMC Med*. 2015;13:210. doi:10.1186/s12916-015-0450-0

PREMIUM TMR: ALL-IN-ONE FEED FOR LAMBS

Nor Dini Rusli

Faculty of Agro-based Industry, Universiti Malaysia Kelantan, Jeli Campus, 17600 Jeli, Kelantan, Malaysia.
Institute of Food Security and Sustainable Agriculture, Universiti Malaysia Kelantan Jeli Campus, Jeli 17600, Kelantan,
Malaysia
nordini@umk.edu.my

**Mira Panadi¹, Khairiyah Mat², Hasnita Che Harun², Mohd Mahmud², Syed Muhammad Al-Amsyar Syed
Abd. Kadir², Mohamad Khairi Mohd Zainol³, Zamzahaila Mohd Zin³**

¹School of Biomedical Engineering and Health Sciences, Universiti Teknologi Malaysia, Skudai, 81300 Johor Bahru,
Johor, Malaysia,

²Faculty of Agro-based Industry, Universiti Malaysia Kelantan, Jeli Campus, 17600 Jeli, Kelantan, Malaysia,

³Faculty of Fisheries and Food Science, Universiti Malaysia Terengganu, 21030 Kuala Nerus, Terengganu
mirapanadi@gmail.com, khairiyah@umk.edu.my, hasnita@umk.edu.my, mohd@umk.edu.my, amsyar@umk.edu.my,
mkhairi@umt.edu.my, zamzahaila@umt.edu.my

Highlights: Premium Total Mixed Ration (TMR) is a balanced mixed feed combining the concentrated feed and forages to meet the nutritional requirement of young sheep. Premium TMR is developed through a new research-based formulation under Fundamental Research Grant Scheme (FRGS 2017). The benefits of Premium TMR for growing lambs include preventing the feed selection, providing more feed intake with high palatability, maintaining the balanced feed ratio of forage to concentrates, preventing diseases and providing stable feed supply and reduction of labour power.

Key words: Total mixed ration; TMR; lamb; sheep; goat; growth performance

Introduction

The COVID-19 pandemic is a health and human crisis threatening the food security and nutrition of millions of people around the world. In the context of the livestock industry in Malaysia, it is well known that ruminant animal is slow in growth and in reproduction. Based on Department of Statistics Malaysia (2020), it shows that only 23% of self-sufficiency level (SSL) for beef and 12% for goat meat or mutton in Malaysia. In addition, meat is one of main food trade deficits in 2018 (-3.2B RM). From year 2016 to 2018, ruminant population in Malaysia was decreased by 10%. The main issue is because of low quality of feed and forages. Hence, it leads to poor nutritional status of ruminant as well as poor animal health.

Premium TMR is a balanced mixed feed combining the concentrated feed and forages to meet the nutritional requirement of young sheep. Premium TMR is developed through a new research-based formulation under Fundamental Research Grant Scheme (FRGS 2017). The formulation of TMR include the local feed resources, for example palm kernel cake, rice bran and copra cake. The forage to concentrate ratio for basal diet and formulated diet was maintained at 60:40 for growing lambs. An adequate level of protein in livestock feed is essential for optimal microbial growth and protein synthesis. Excess protein consumption can result in a lot of waste, especially nitrogen (N), which can pollute the environment (Chandrasekharaiah et al. 2011).

In term of education, this innovation can encourage all students including school students to get to know about the importance of balanced diet for farm animal. Proper nutrition is essential to health and productivity of the animals. The process of formulating Premium TMR from raw agricultural products can also be a good insight for the students about the benefits from the utilisation of agricultural waste. It is imperative that ruminant feed needs to be utilised from agricultural by-products rather than grains grown for human nutrition. The utilisation of agricultural by-product needs urgent attention by adopting proper approaches to recycle and reuse it as well as upgrade its potential as animal feed.

Premium TMR is the first, established TMR that provides optimum crude protein (CP) requirement for growing lambs raised in Malaysia. After the establishment of this product through research & development (R&D) for 3 years, it was suggested that the optimum CP level for growing lamb raised in Malaysia was 16%. The growth performance of lambs which include final body weight, average body weight gain (ADG), residual feed intake (RFI) and residual body weight gain (RIG) were improved by a minimal CP level of 16 % (Table 1). The additional CP level over these requirements did not improve the growth performance of lambs. Table 1 shows the effect of varying CP levels in grower ration resulted in the linear increase of final body weight of growing lambs. The final body weight of growing lambs in GR16 (36 kg) was significantly ($P < 0.05$) higher than those in CON11 (27.33 kg) and GR14 (30.20 kg). However, there were quadratic effects of varying CP levels on ADG of growing lambs. The ADG was decreased when fed on a diet containing 18 % CP (GR18). In general, the RWG and RIG were found non-significant ($P > 0.05$) in all treatments.

The benefits of Premium TMR for growing lambs include preventing the feed selection, providing more feed intake with high palatability, maintaining the balanced feed ratio of forage to concentrates, preventing diseases and providing stable feed supply and reduction of labour power. For the farmers, the use of Premium TMR can reduce the medication cost of the animals by 50% and faster the growth of lambs. Thus, lambs can be sold quicker than usual time. In term of investor's benefits; the revenue channels for Premium TMR are the sale, product licensing and consultation charge. It is expected that the ROI of Premium TMR will be achieved in Year 3. The benefits of Premium TMR to market ecosystem will be the improvement of ruminant performance thus the production of meat and milk will be increased.

In term of commercial value of Premium TMR, the market size is about 10,000 breeders of small ruminants in Malaysia. After this product gets into the market, it is expected that this product will share about 30% of market share with other existing products in the market. In addition, the serviceable addressable market (SOM) will be 15000 breeders in East Coast Malaysia. Our team has a good industrial collaboration with Agropolitan-Setiu, Besut Terengganu and also Sepadu Rumi Sdn Bhd.

Table 1 Growth performance of growing lambs fed with TMR at different crude protein levels

Parameters	Treatment groups (mean \pm standard error)				P-value	
	CONTROL DIET	GR14	GR16 (Premium TMR)	GR18	Linear	Quadratic
Initial body weight (kg)	23.67 \pm 0.33 ^a	24.00 \pm 1.38 ^a	27.00 \pm 1.53 ^{ab}	28.50 \pm 1.20 ^b	0.013	0.673
Final body weight (kg)	27.33 \pm 0.67 ^a	30.20 \pm 1.83 ^a	36.00 \pm 1.53 ^b	34.40 \pm 1.83 ^{ab}	0.006	0.246
ADG (g/d)	43.14 \pm 10.38 ^a	72.94 \pm 5.76 ^{ab}	105.88 \pm 17.97 ^b	69.41 \pm 13.21 ^{ab}	0.064	0.019
RFI	-0.10 \pm 0.04 ^{ab}	0.08 \pm 0.03 ^b	-0.30 \pm 0.23 ^a	0.16 \pm 0.01 ^b	0.348	0.152
RWG	-0.007 \pm 0.007	0.010 \pm 0.004	0.013 \pm 0.007	-0.013 \pm 0.008	0.746	0.039
RIG	0.09 \pm 0.05 ^b	-0.07 \pm 0.03 ^a	0.31 \pm 0.21 ^c	-0.17 \pm 0.02 ^a	0.305	0.085

^{a,b} Different superscripts within the same row indicate significant differences ($P < 0.05$)

ADG = average daily gain, RFI = residual feed intake, RWG = residual body weight gain, RIG = residual intake and body weight gain

CON14 = control diet at 14 % of CP, CF16 = creep feed at 16 % of CP, CF18 = creep feed at 18 % of CP, CF20 = creep feed at 20 % of CP, CON11 = control diet at 11 % of CP, GR14 = grower ration at 14 % of CP, GR16 = grower ration at 16 % of CP, GR18 = grower ration at 18 % of CP

Acknowledgement

The author wishes to express the gratitude to the Ministry of Higher Education for funding this research through the Fundamental Research Grant Scheme (FRGS): R/FRGS/A.06.00/00534A/007/2017/000439.

References

Chandrasekharaiah, M., Thulasi, A., Sampath, K.T. (2011). Microbial protein synthesis, nitrogen capture efficiency and nutrient utilisation in sheep fed on finger millet straw (*Eleusine coracana*) based diet with different rumen degradable nitrogen levels. Journal of the Science of Food and Agriculture, 91, 1505–1510.

FUELLING FUTURE TREASURE: COMMUNITY-BASED E-WASTE RECYCLING MODEL

Marieanne Christie Leong

Faculty of Earth Science, Universiti Malaysia Kelantan Jeli Campus, Jeli, 17600 Kelantan, Malaysia
marieanne@umk.edu.my

Aweng Eh Rak¹, Suganthi Appalasamy¹, Amal Najihah Muhamad Nor¹, Nur Aqilah Azmi¹, Jayaraj Vijaya Kumaran¹, Wong Hie Ling¹, Muhammad Firdaus Abdul Karim¹, Robin Sebolino²

¹Faculty of Earth Science, Universiti Malaysia Kelantan Jeli Campus, Jeli, 17600 Kelantan, Malaysia

²University of Asia and the Pacific, Pearl Drive, Ortigas Center, Pasig City, 1605, Metro Manila, Philippines
aweng@umk.edu.my, suganthi.a@umk.edu.my, amalnajihah@umk.edu.my, aqilahazmi135@gmail.com, jayaraj@umk.edu.my, hlwong@umk.edu.my, firdaus.ak@umk.edu.my, robinjason.sebolino@uap.asia

Highlights: Billions of precious metals and rare earth elements go to waste annually due to unsustainable consumerist behaviour and management on electronic goods. The current practices of disposal and recycling of electronic wastes (e-wastes) are unsatisfactory due to improper regulations and lack of functional facilities to adopt e-waste recycling practice. A localised youth movement to facilitate nationwide e-waste recycling was innovated. The pandemic-imposed movement restriction order was leveraged to deliver localised experiential learning for youths to collect, sell or dispose of e-waste responsibly. A major outcome of this project is a community-based e-waste recycling model with great potential for commercialisation.

Key words: e-Waste recycling, climate action, youth empowerment, community

Introduction

The rapid technological advancement has resulted in increased consumption of natural resources, especially precious raw metals (e.g., gold, copper) and rare earth elements (e.g., yttrium, terbium) to produce electronic goods. Grave consequence at the end of the goods' lifespan is the accumulation of electronic wastes (e-waste) that have yet seen proper and responsible recycling practices. Globally, the number of e-wastes increase unprecedentedly at the rate of 4 – 5% annually (Islam et al., 2016). In Malaysia, the number of e-waste produced in 2019 was 364 kilotons, an increase of 17% from 2015 (Global Waste, 2021).

The lack of sustainable practices in e-waste management in Malaysia is dampened by lack of (i) educational awareness on the dangers and treasures of e-wastes, (ii) e-waste recycling facilities, (iii) incentives to promote e-waste recycling, (iv) continuity in e-waste recycling campaigns, and (v) poor coordination and performance between governmental agencies (e.g., Department of Environment Malaysia, DOE) and e-waste collectors, to name a few of the challenges.

For instance, despite the effort of DOE in building web- (<http://www.doe.gov.my/hhew/>) and mobile-based application (MyEwaste), community participation is unsatisfactory (only 100+ downloads of MyEwaste app). The app also received poor reviews on the lacklustre technical and content performance, as well as the already few recycling facilities being limited only in major cities. Moreover, the app is almost pointless in East Malaysia. The incomprehensive list of recycling facilities in the app are likely due to most recycling enterprises being overlooked by the DOE or that they are not registered with the DOE.

Virtual and field surveys from this project found several recycling enterprises in small localities that were not included on the website/ app. Therefore, as initial first step to reduce the gap in the inadequacy and fleeting campaigns of e-waste recycling, a localised, youth-driven movement was deployed to be the catalyst in bringing e-wastes to respective recycling facilities.

Description of the project

Our **unique approach** is in **leveraging the pandemic-imposed movement restriction order**, turning this restriction into an opportunity to extend virtual distance learning by providing **localised experiential learning with nationwide geographical coverage** and at the same time **solving local community problem** – the build-up of e-wastes and not knowing where to dispose of them.

Google Maps was used as a tool to pinpoint students' home locations and e-waste collection. Collection facilities were then categorised into buying and non-buying collectors and items that are accepted by each collector were identified and sorted into those providing collection services or drop-off services for logistics planning. Social media and e-communication tools were used to circulate marketing posters and videos to reach out to both local communities and netizens.

Motivation of the project

- i. To provide impactful, localised experiential learning to the students.
- ii. To solve the largely unaware crisis of e-waste.
- iii. To create a conceptual model for community-based e-waste recycling.

Importance to education

This project is important to education as it provides experiential learning that extends out from their classroom education. Moreover, it serves as a testament that despite the pandemic situation, students are still able to carry out their social responsibility within their means.

Advantages towards education and community

i. Meaningful and fulfilling educational activities that elevate youth empowerment and ownership

Through educating students on both the harmful threats and precious treasures of e-waste, the students were able to internalise this knowledge and transform them into an action that contribute to reducing the adverse impacts of improper e-waste disposal. The action they undertake gave them a sense of pride, ownership, empowerment and achievement in being an agent of change who contribute to positive impacts to the environment.

ii. Conceptual model for community-based e-waste recycling programme

The students were able to educate people about the threats and treasures of e-wastes. The people who have reached out to donate their e-wastes were very thankful for such effort as they were able to get rid of their long-kept, broken or unwanted e-wastes, knowing that they are being disposed of responsibly. Figure 1 shows a conceptual model developed from this project.

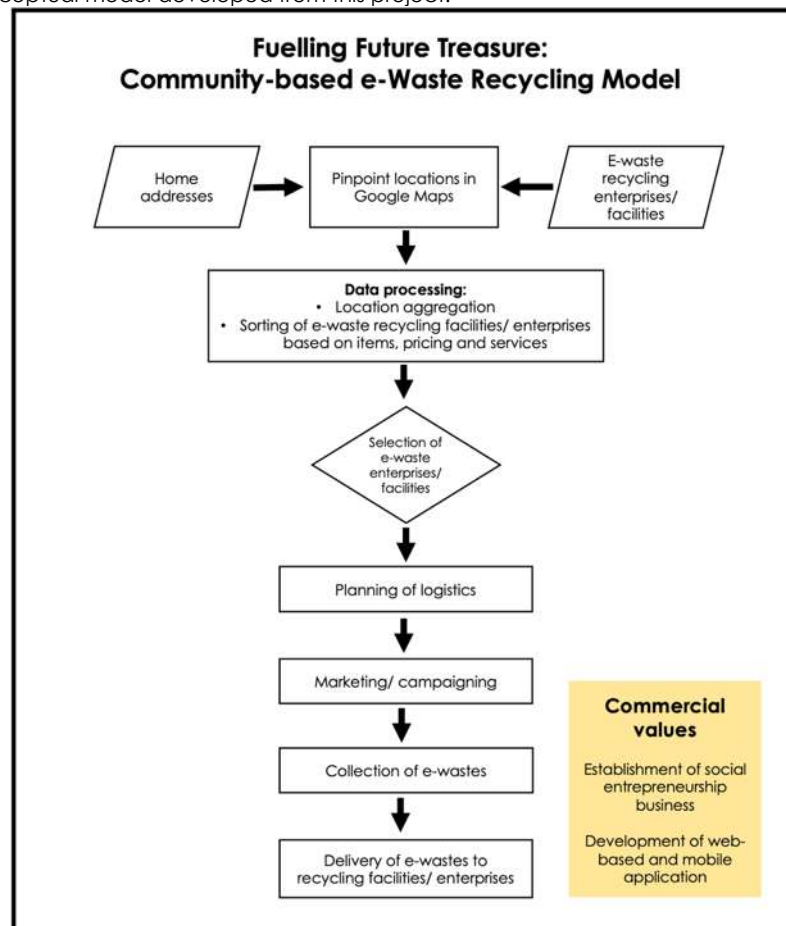

Figure 1 Conceptual model for community-based e-waste recycling programme.

Commercial values

- Establishment of social entrepreneurship business.
- Development of a more robust web and mobile application for e-waste collection that fulfils the needs of users.

This project is highly adoptable at all levels. Performing collection of e-waste and thereafter selling them to e-waste collectors within the community area reduces transportation costs, thus maximising profit gain. The estimated profit gain from this project trial in 29 areas across Peninsular Malaysia, Sabah and W. P. Labuan is RM 395.30 over a span of one month (May 2021).

Acknowledgement

We are grateful for the generous contribution of e-wastes from the community.

References

Department of Environment Malaysia. Household e-waste. <http://www.doe.gov.my/hhew/>. Last retrieved on 22.06.2021.

Department of Environment Malaysia. Hebahan muat turun aplikasi mobile myewaste di telefon pintar. <https://www.doe.gov.my/portalv1/en/info-hebahan/pengumuman-bergambar/hebahan-muat-turun-aplikasi-mobile-myewaste-di-telefon-pintar/329055>. Last retrieved on 22.06.2021.

Global Waste. Malaysia – 2019 – e-waste statistics. <https://globalewaste.org/statistics/country/malaysia/2019/>. Last retrieved on 22.06.2021.

Islam, M. T., Abdullah, A. B., Shahir, S. A., Kalam, M. A., Masjuki, H. H., Shumon, R., & Rashid, M. H. (2016). A public survey on knowledge, awareness, attitude and willingness to pay for WEEE management: Case study in Bangladesh. Journal of cleaner production, 137, 728-740.

Notes:



Poster

<https://drive.google.com/file/d/17mZ-PjYgr36X09FGzkv57OellFGW9kMY/view?usp=sharing>



Video

<https://youtu.be/L-V0n4T4KuM>



LinkedIn

<https://linkedin.com/in/marieanneleong>

DEVELOPMENT OF STRAW MUSHROOM (*VOLVARIELLA VOLVACEA*) FLOUR AND ITS APPLICATION IN BAKING PRODUCT

Saw Wei Xian

Faculty of Agro-Based Industry, University Malaysia Kelantan, Malaysia swxian.f17a0199@siswa.umk.edu.my

Noor Hafizoh Binti Saidan

Faculty of Agro-Based Industry, University Malaysia Kelantan, Malaysia hafizoh.s@umk.edu.my

Highlights: This project analyzes and evaluates new products by improving the ingredient flour to make gluten-free bread. The straw mushroom (*Volvariella volvacea*) is supplemented with gluten-free and wheat bread. This study aims to improve the proximate composition and physical characteristics of gluten-free bread supplemented from mushroom flour powder. The analysis method includes proximate analysis following AOAC (2000) standard, physical analysis on the characteristic of bread using texture analyzer, and Minolta Colorimeter. The findings provide scientific proof that gluten-free bread supplemented with mushroom flour powder has increased its protein, fibre, ash, and carbohydrate content and lowered its moisture content. The texture of gluten-free bread can mimic the texture of wheat bread after the addition of mushroom flour. This research is beneficial for those with gluten intolerance. They can consume this gluten-free bread supplemented with mushroom flour to gain the same level of nutrition as wheat bread.

Key words: *Gluten, gluten-free bread, mushroom flour, wheat flour, gluten intolerant*

Introduction

Bread is a dietary product, and people take bread as the foundation of their meal. Most studies on gluten-free food have been carried out on celiac disease, which leads to problems with gluten, and the most effective way to manage the symptom is to eliminate gluten from their daily diet. However, gluten-free food derived from cereals lacks macronutrients and micronutrients (Flores Quan et al., 2018). This problem can cause an imbalance of nutrients for people who have celiac disease. Therefore, the development of gluten-free food is essential in considering nutritional value, health benefits, and taste. This research aims to improve gluten-free bread's nutritional value with mushroom flour powder supplements (Ho et al., 2020). Mushroom is a naturally gluten-free source which consists of protein, vitamin, dietary fiber, and other nutrients that benefit the human body. Adding mushroom flour in making gluten-free bread is planned to replace wheat flour in bread making. Hence, various research and experiments were used to improve the texture and taste of the bread.

Product Description

Gluten-free bread was developed with the addition of *V. volvacea* mushroom flour powder. The mushroom was washed with clean water and blanched for 7 min. The mushroom was dried in the oven at 55 °C – 60 °C for 120 min. The dried mushroom was blended into powder and sieved through a 20 mesh/inch sieve. Next, the mushroom flour powder has used in making gluten-free and wheat bread. Bread samples were prepared by mixing all the dry ingredients like flour, salt, sugar, baking powder, and water, egg, and oil. The mixture was poured into the mold and baked at 170 °C for 45 min. A sample of gluten-free bread supplemented with mushroom flour (GMB), gluten-free bread without mushroom flour (GB), wheat bread sample supplemented with mushroom flour (WMB), and wheat bread without mushroom flour (WB) was produced.

Result and Discussion

There are four types of flour and bread sample in the proximate analysis: *V. volvacea* mushroom flour, gluten-free flour, wheat flour, cornflour, gluten-free bread, wheat bread, and bread sample added with mushroom flour. The proximate analysis is crucial for determining the nutrition content in protein, fat, fiber, ash, moisture, and carbohydrate. Each of these proximate contents may influence the physical characteristic of the bread produced and studied through the result.

Table 1: Proximate, physical analysis, and colour of the sample.

Type of Flour	Type of Bread									
	Mushroom (Volvacea) Flour	Gluten-Free Flour	Wheat Flour	Corn Flour	Gluten-Free Bread with Mushroom Flour Powder	Gluten-Free Bread without Mushroom Flour Powder	Wheat Bread with Mushroom Flour Powder	Wheat Bread without Mushroom Flour Powder		
Proximate Analysis	Crude Protein (%)	28.75±0.05	6.15±0.07	11.73±0.05	1.40±0.06	5.78±0.09	9.15±0.04	8.71±0.09	9.19±0.02	
	Crude Fat (%)	1.34±0.09	1.13±0.17	2.30±0.11	0.30±0.18	7.74±0.04	7.34±0.02	8.57±0.05	8.98±0.06	
	Crude Fiber (%)	6.84±0.08	0.40±0.10	1.17±0.10	0.55±0.06	0.95±0.09	1.60±0.00	1.28±0.02	0.92±0.06	
	Ash (%)	6.03±0.07	1.70±0.05	1.59±0.04	1.37±0.01	4.95±0.02	5.09±0.03	2.59±0.03	2.73±0.07	
	Moisture (%)	19.16±0.08	14.46±0.11	13.67±0.09	13.30±0.07	31.55±0.02	31.70±0.03	32.75±0.03	33.56±0.05	
	Carbohydrate (%)	37.96±0.11	76.17±0.24	69.54±0.20	83.08±0.18	49.03±0.15	45.11±0.01	46.01±0.03	44.63±0.04	
Physical Analysis	Hardness (g)						930.67±2.49	2459.33±2.62	2201.67±2.49	
	Chewiness						1154.33±2.52			
							48.34±0.07	59.62±0.04	57.05±0.05	64.74±0.07
Colour	Lightness (L*)						27.78±0.05	34.19±0.05	41.81±0.04	45.33±0.05
	Redness (a*)						2.58±0.03	4.04±0.05	2.7±0.04	5.7±0.05
	Yellowness (b*)						22.25±0.05	28.34±0.05	26.15±0.03	27.52±0.05

Note: Value represents the mean ± standard deviation

The protein content was highest in mushroom flour (28.75 %). The study of Okafor et al. (2012) discovered that lysine is one of the amino acids that lack in wheat, while mushroom is particularly remarkable in lysine. Thus, the mushroom regarded as a good source of protein in the human diet as mushrooms rich in lysine, which can replenish the protein deficiency in cereal food (Sadler, 2003). The total fat content found in mushroom flour, gluten-free flour, and cornflour was lower than wheat flour. The fiber content in mushroom flour (6.84 %) was higher among the flour samples. Mushroom flour has the highest level of ash content (6.03 %) which indicates higher amount of minerals compared to others flour. Besides that, the moisture content was highest in mushroom flour (19.16 %). Mushroom flour has lesser carbohydrate content (37.96 %) which consists of sugar alcohol that gives a sweet taste but does not fully absorb by the body and fewer calories (Okoro, 2012).

Result shows the percentage of protein's mean value, moisture, and ash increased with mushroom addition in gluten-free and wheat bread. The high amount of fibre content in mushroom flour exerts water absorption capacity and prevents moisture from evaporates during baking cause the moisture content shows an increase in mushroom flour added to bread sample (Kurek et al., 2015). From the research of Towo et al. (2011), mushroom flour could be added into a low mineral foodstuff to combat iron, zinc, and other micronutrient deficiencies. Besides, the crude fat content in gluten-free bread was a remarkable decrease with mushroom flour addition, which is 7.74 % and 7.34 % separately. It may occur due to the low-fat content in mushroom flour, and when mixed with low-fat, gluten-free flour causes the fat level in bread was slightly affected (Wan Rosli et al., 2011).

In contrast, wheat bread has a significant increase in crude fat content with mushroom flour, 8.57 % and 8.97 %, respectively. The effect of mushroom flour addition in different types of bread may have differed the fat content of bread due to the flour's origin fat content. The crude fiber content increased in gluten-free bread added with mushroom flour but decrease in wheat bread. Therefore, the mushroom flour powder added into the gluten-free bread sample enhances its fibre content and surpasses wheat bread with mushroom flour supplemented (Hager, 2013). Moreover, there was a decrease in carbohydrate content in both bread samples added with mushroom flour. High carbohydrate food provides extra glucose as fat and triggers insulin to balance blood glucose, while low carbohydrate diets help weight loss in obese.

In addition, the data above demonstrates the texture profile analysis (TPA) of bread samples in hardness and chewiness. The hardness value decreased in both gluten-free and wheat bread with mushroom addition. The decrease in bread hardness may occur due to the higher protein content of mushroom flour that can exert the capacity of water holding properties and prevent moisture loss from baking cause the hardness of bread decreases after mushroom flour addition (Li et al., 2018). Chewiness can be expressed as the amount of energy needed to masticate food before swallowing and elastic food resistance (Salehi et al., 2016). The TPA shows the chewiness value increase in both gluten-free and wheat bread after added with mushroom flour.

The colour showed the value of L* indicates the luminance in which the white objects are dignified from grey while light objects from dark colour. There was an increasing trend in the bread lightness intensity with mushroom flour increment. Besides that, the higher a* value indicates the red to green colours of the lower a* value. Compared to the redness between the gluten-free and wheat bread, the gluten-free bread with mushroom flour addition has lesser redness than wheat bread. Lastly, there is an increasing trend in the value of b* with mushroom flour addition in the bread sample. Overall, as mushroom flour was added into a bread sample, the value of L*, a*, and b* increased, indicating that a lighter, redder, and yellow bread sample was produced.

Commercialisation

V. volvacea Mushroom flour powder has the potential of marketability in terms of replacing or as a new ingredient in baking or cooking. It addresses the four key points in the target market: product, people, price, and place in developing a marketing mix. For the product key point, mushroom flour consists of economic value which as a protein supplement in baked goods like bread, biscuit or cereal products. It contains soluble and insoluble fibre such as beta-glucans and chitosans, which can help manage cholesterol level, blood glucose level, and cardiovascular disease. In addition, it replenishes the deficiency in gluten-free food, which lacks protein and fiber content compared to gluten food. The high ash content of mushroom flour helps combat micronutrient deficiency. Low carbohydrate content attributed by sugar alcohol can introduce baked goods as a reduced-calorie sweetener with fewer calories. The low carbohydrate content of the mushroom flour helps to manage obesity as well. This product target people who seek for healthy food and help people with gluten intolerant gain the same level of nutrient as gluten food while consuming gluten-free food. Next, it is important to evaluate how much the product is offered when developing a market mix. The value must be affordable; the price composition strategies must be effective in discount is given and market quotation. Lastly, the place key point involves of market, channel, and distribution while developing the market mix to ensure this product is available to consumers.

Acknowledgement

I want to convey my deepest gratitude to my research supervisor, Dr. Noor Hafizoh Binti Saidan, who gave a lot of help and useful advice to guide me during this research. Lastly, thanks for all the support from my friends, whether spiritually or financially support. This report would not have been accomplished without all of these people.

References

- Flores Quan, C. V., Redecillas Ferreiro, S. E., & Cantón, O. S. (2018). Gluten-free diet: Always as easy, useful, and healthy as people think? *Journal of Child Science*, 8(1), e75–e81.
- Hager, A.-S. (2013). Cereal products for specific dietary requirements Evaluation and improvement of technological and nutritional Doctor of Philosophy-PhD in Food Science and Technology.
- Ho, L.-H., Asyikeen Zulkifli, N., & Tan, T.-C. (2020). Edible Mushroom: Nutritional Properties, Potential Nutraceutical Values, and Its Utilisation in Food Product Development. An Introduction to Mushroom.
- Kurek, M. A., Wyrwisz, J., Pawińska, M., & Wierzbicka, A. (2015). Influence of the wheat flour extraction degree in the quality of bread made with high proportions of β-glucan. *Food Science and Technology*, 35(2), 273–278.
- Li, L., Wang, N., Ma, S., Yang, S., Chen, X., Ke, Y., & Wang, X. (2018). Relationship of Moisture Status and Quality Characteristics of Fresh Wet Noodles Prepared from Different Grade Wheat Flours from Flour Milling Streams. *Journal of Chemistry*, 2018.
- Okafor, J. N. C., Okafor, G. I., Ozumba, A. U., & Elemo, G. N. (2012). Quality characteristics of bread made from wheat and Nigerian oyster mushroom (*Pleurotus pulmonarius*) powder. *Pakistan Journal of Nutrition*, 11(1), 5–10.
- O. Okoro. (2012). Proximate and mineral analysis of some wild edible mushrooms. *African Journal of Biotechnology*, 11(30), 7720–7724.
- Sadler, M. (2003). Nutritional properties of edible fungi. *Nutrition Bulletin*, 28(3), 305–308.
- Salehi, F., Kashaninejad, M., Asadi, F., & Najafi, A. (2016). Improvement of quality attributes of sponge cake using infrared dried button mushroom. *Journal of Food Science and Technology*, 53(3), 1418–1423.
- Towo, E., Mgoba, C., Ndossi, G., & Kimboka, S. (2011). Effect of phytate and iron-binding phenolics on the content and availability of iron and zinc in micronutrient fortified cereal flours. *African Journal of Food, Agriculture, Nutrition and Development*, 6(2), 1–14.
- Wan Rosli, W. I., Solihah, M. A., Aishah, M., Nik Fakrudin, N. A., & Mohsin, S. S. J. (2011). Colour, textural properties, cooking characteristics and fibre content of chicken patty added with oyster mushroom (*Pleurotus sajor-caju*). *International Food Research Journal*, 18(2), 621–627.

A CASE STUDY – IMPACT OF COVID-19 ON LIVESTOCK FARMERS IN KELANTAN

Nur Syuhada Sazali

Faculty of Agro Based Industry, Universiti Malaysia Kelantan, Jeli 17600, Kelantan, Malaysia
nursyuhada.sazali02@gmail.com

Mohammad Mijanur Rahman, Khairiyah Mat, Nor Dini binti Rosli, and Raja Ili Airina binti Raja Khalif

Faculty of Agro Based Industry, Universiti Malaysia Kelantan, Jeli 17600, Kelantan, Malaysia
mijanur.r@umk.edu.my, khairiyah@umk.edu.my, nordini@umk.edu.my, airina@umk.edu.my

Highlights: Malaysia has implemented the first Movement Control Order (MCO) at the end of March 2020 to reduce the spread of the coronavirus during the COVID-19 pandemic. A survey was conducted using a standard questionnaire during the recovery MCO period to better understand the impact of the COVID-19 pandemic on food security, poverty, and development of smallholder livestock farmers. A total of 100 farmers in ten districts of Kelantan were involved in the survey. The study found that the COVID-19 pandemic has negatively affected smallholder livestock farmers in Kelantan. Farmers have started to adjust their plans on improving their farms.

Key words: *impact, COVID-19 pandemic, smallholder livestock farmers, movement control order (MCO)*

Introduction

The Covid-19 pandemic, which was caused by the emergence of a coronavirus at the end of December 2019, has led to a global public health emergency and a socioeconomic crisis in 2020. The first COVID-19 case was detected in Malaysia on January 25 among Chinese tourists arriving via Singapore. By February 16, the number of cases had risen to 22, indicating the first wave of cases. On February 27, the second wave of cases began, taking the total number of people infected with the coronavirus to over 1,000 (Pfordten & Ahmad, 2021). Malaysia had the highest total number of confirmed COVID-19 cases in Southeast Asia within weeks, with 4,817 cases, 77 deaths, and 2,276 cases of recovery announced by the Ministry of Health (MOH) in Malaysia as of April 13, 2020 (Umair, Waqas & Faheem, 2021). During the COVID-19 pandemic, Malaysia has implemented a Movement Control Order (MCO) to prevent the pandemic from spreading. All economic, social, agricultural, and other activities were entirely halted as a rule of the MCO. Malaysia's agriculture supply chain has been disrupted due to the implementation (Amir et al., 2020).

COVID-19 has had a significant impact on many sectors, including livestock, globally, regional, and national levels. Many countries' actions, such as lockdown, travel restrictions, and border controls, had unwanted or unfavorable effects on the livestock industry, including difficulty transporting live animals and animal products to markets. These difficulties have caused a decline in animal product processing capability, a drop in income, and a slowdown in business activity. Furthermore, as the disease spreads, movement restrictions become increasingly strict, resulting in labour shortages for the harvest or difficulties for farmers in transporting their products to market (Bekuma, 2020).

A secure supply of agricultural products is essential for a healthy and functioning economy and people's livelihoods. As a result, sustaining the livestock sector is a critical economic component in the ongoing battle against the outbreak; however, their hardships have received little exposure. Thus, this study aims to understand the operational situation and demands of smallholder livestock farmers impacted by the COVID-19 pandemic through a standard questionnaire.

Content

This study was carried out to better understand COVID-19's effects in the livestock sector, focusing on the food security, poverty, and development of smallholder farmers. A semi-structured survey questionnaire was developed and pre-tested. With a few slight adjustments, the final questionnaire included few sections with several questions that were addressed mainly about: farmer's basic information, information of farms, farm management, animal health management, and action taken during COVID-19 restrictions. This survey involved 100 farmers in ten districts (Bachok, Gua Musang, Kota Bharu, Kuala Krai, Machang, Pasir Mas, Jeli, Tanah Merah, Pasir Puteh and Tumpat) of Kelantan (10 questionnaires from each district). Each interview was conducted face to face only after the given consent of the respondent farmer to attend the interview. The questions were asked only to the farmer who directly maintains the farm. The main concern from the smallholder livestock farmers during the early phase of MCO was the changes in farm or business due to COVID-19 where the farmers are encountering the decreased product's demand, reduced income, financial loss, and decreased product's price which about 55%, 49%, 32%, and 15% respectively. About 43%, 29%, 18%, and 5% of the respondents are selling their products directly from the farm, online, to butcher, and to restaurant, respectively. But still, approximately 91% of respondents have internet access and 86% of respondents stated that their internet facilities are helping their business in various ways as an alternative channel throughout the MCO.

This study was important in providing information regarding the problem faced by smallholder livestock farmers and how severely COVID-19 impacts the livestock sector. This study will also help giving recommendations and some actions that need to be taken that can assist smallholder livestock farmers in bringing the farm back to life. Furthermore, the government will be able to better comprehend the operating conditions and demands of smallholder livestock farms affected by the COVID-19 pandemic through this study. Thus, the government could make financial assistance available to smallholder livestock farmers to help them support their businesses and reduce the effect of the COVID-19 pandemic on the livestock sector.

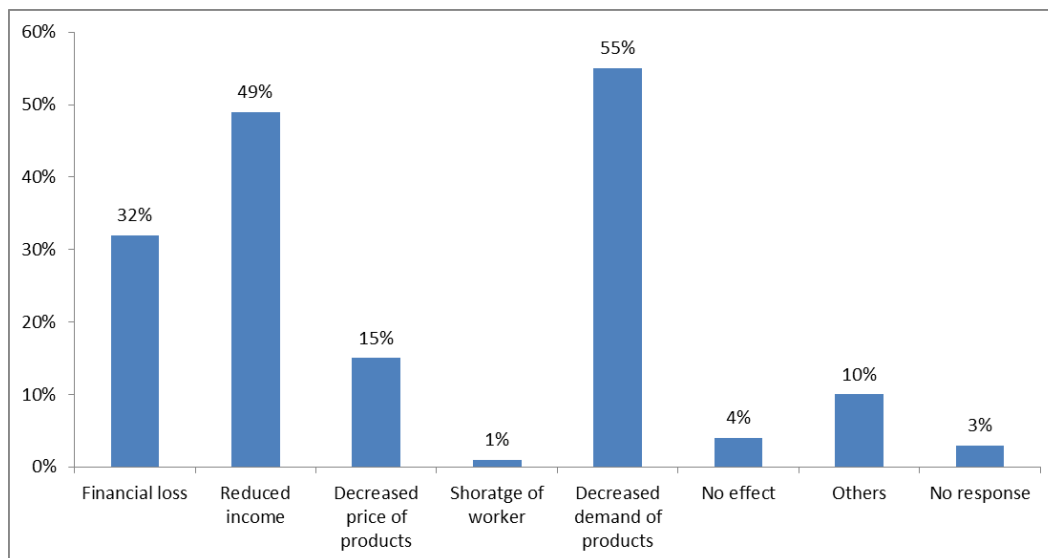

Figure 1: Respondents response about changes in farm or business due to COVID-19.

Acknowledgement

The authors would like to thank Universiti Malaysia Kelantan for financial support to conduct this research under the internal research grant (R/C19/A0700/0157A/002/2020/00776).

References

- Amir, H. M., Abidin, A. Z. Z., Rashid, K. F. A., & Suhaimie, S. (2020 December 23). Agriculture Food Supply Chain Scenario during the COVID-19 Pandemic in Malaysia. *FFTC Agricultural Policy Platform (FFTC-AP)*. <https://ap.fftc.org.tw/article/2679>.
- Bekuma, A. (2020, December 18). Impact of COVID - 19 on Livestock Production and Best Practices to Devastate. Retrieved from https://www.researchgate.net/publication/347443733_Impact_of_COVID_-19_on_Livestock_Production_and_Best_Practices_to_Devastate.
- Pfordten D., & Ahmad, R. (2020). Covid-19: current situation in Malaysia. *The Star*. Retrieved from <https://www.thestar.com.my/news/nation/2020/03/23/covid-19-current-situationin-malaysia-updated-daily>.
- Umair, S., Waqas, U., & Faheem, M. (2021). COVID-19 pandemic: stringent measures of Malaysia and implications for other countries. *Postgraduate Medical Journal* 97: 130-132.

IRFRAM WASTE TRAP

Muhammad Ramzi Bin Ramli

Polytechnic of Kota Bharu, Kota Bharu, Kelantan
ramzi6698@gmail.com

Muhammad Irfan Bin Asri, Affidah Mardziah binti Mukhtar

Polytechnic of Kota Bharu, Kota Bharu, Kelantan
lmuhd6447@gmail.com, affidah.mukhtar@gmail.com

Highlights: Problems of dumping garbage in waterways whether in water lines, rivers, drains and so on often occur. This causes an unpleasant odor and may cause illness to the locals. In addition, the risk of flash floods can also occur due to clogged garbage. The objective of this project is to design an IRFRAM waste trap, identify the appropriate flow rate to allow garbage to enter the waste trap and identify the quantity of garbage will be trapped by this waste trap. The methodology for this study is more of an experimental study, where the IRFRAM waste trap product is produced in a laboratory/workshop and then the product is tested for its effectiveness in several proposed locations. The results of the study are expected to provide a new innovation in the field of civil engineering and waste engineering. The potential for this product to be used in the community is clear.

Key Words: waste trap, garbage, waterways, flow rate, effectiveness

Introduction

Nowadays, the issue of clogged waterways is increasingly causing concern among the community. Among the problems that occur due to clogged waterways is the problem of flash floods. In addition, incessant rain of 5-6 hours dive on clogged waterways can cause the channels to be unable to accommodate large amounts of rainwater and cause flooding. Flash floods have the potential to destroy community property. (Federal Territory of Kuala Lumpur DID, 2020)

According to Mohd Khidir Zakaria (2020), among other problems when waterways are clogged are, foul smell caused by piles of garbage accumulated on the waterways and cause disease risk to local residents. Therefore, the steps that need to be taken to prevent waterways from clogging are by installing waste traps in waterways that have the potential to become clogged.

The waste trap that will be made is the IRFRAM waste trap which is designed to control the problem of clogged water channels in a more effective way. With the presence of these IRFRAM waste traps, problems such as flash floods, foul odors, and diseases caused by clogged drains can be controlled and reduced efficiently.

Product Development, Design and Process

The production of IRFRAM waste traps is referred to figure 1: Flow of methodology below. Once the problem statement of the study is identified then the objectives of the study are formed. After that the research methodology is determined to ensure that the objectives can be achieved. Production of IRFRAM products began to be implemented and testing of the products was made. Analysis of the use of IRFRAM products is made to ensure that the objectives can be achieved or not.



Figure 1: Flow of methodology

The design of the IRFRAM product produced is based on a study of the pros and cons of several previous products such as Log Boom, Trash Screen and net types. Next, the design characteristics of waste traps, namely flow rate, maintenance, load estimation and channel type must be met to produce an efficient waste trap (Khairul Anuar, 2008).

Result

As a result of the design study made, the following is a sketch of the IRFRAM waste trap product:

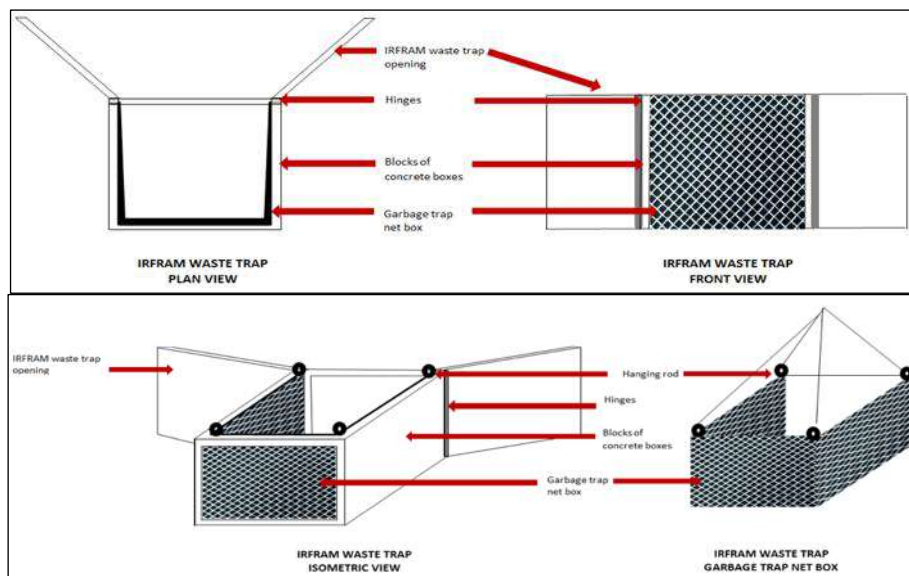

Figure 2: IRFRAM Waste Trap Design

The function of the IRFRAM waste trap is as follows:

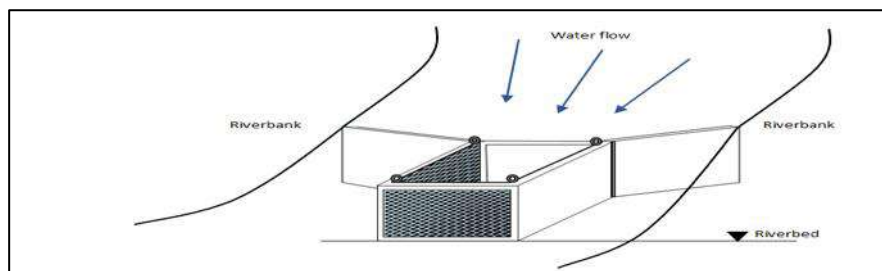





Figure 3: IRFRAM Waste Trap Function

IRFRAM Waste Traps are made from concrete blocks to ensure sufficient weight to prevent the waste traps from drifting. The bottom part of the waste trap must be flat on the bottom part of the river. The opening of the trap will be adjusted to the surface of the river bank to prevent all garbage from escaping. Garbage will move into the waste trap with the appropriate flow rate. Once the garbage quantity is full, the net container inside the waste trap will be lifted out and the garbage is taken for disposal at the landfill.

Discussion

The results of the study have shown that the design idea of this IRFRAM Waste Trap is expected to be able to accommodate all the disadvantages of the existing waste trap product. The comparison can be shown through Table 1 : Comparison of existing waste trap types with IRFRAM Waste Traps.

Table 1 : Comparison of existing waste trap types with IRFRAM waste traps

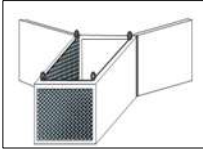
TYPE OF WASTE TRAP	LOG BOOM	TRASH SCREEN	NET WASTE TRAP	IRFRAM WASTE TRAP
				
DESIGN	Extend across the river to restrict the flow of garbage	Inclined or vertical mesh,	is a sack net waste trap placed on the surface of the Culvert	waste trap for rivers or ditches
TYPE OF CHANNEL	Large width	Narrow water channel	Narrow water channel	Simple channel
CHANNEL FLOW RATE	Slow	Normal	Normal	Normal and a bit speedy
QUANTITY OF WASTE RETAINED	50-60%	0%	00%	0%
COST OF WASTE COLLECTION	RM60.00-RM70.00 for a tone of garbage	M80.00-RM100.00 for a tone of garbage	M80.00-RM100.00 for a tone of garbage	M40.00-RM50.00 for a tone of garbage
OTHERS	<ul style="list-style-type: none"> Garbage other than 50-60% will sink to the bottom Fish habitat is disturbed 	<ul style="list-style-type: none"> Garbage is easily clogged on the net poses a risk of flooding if not properly maintained and cleaned regularly. 	<ul style="list-style-type: none"> requires high costs, a lot of work and a lot of manpower to install and maintain these traps 	<ul style="list-style-type: none"> Easy to maintain low risk of damage

Resources : Mohd Najmie Bin Mohd (2007)

Acknowledgement

We would like to thank Polytechnic of Kota Bharu, Kelantan for their assistance and technical management as well as space and assets belonging to the institution during the process of conducting this study.

References

- JPS Wilayah Persekutuan Kuala Lumpur (2020) Peningkatkan sistem perparitan di Lembah Klang. Laporan Tahunan Tahun 2020 <http://state.water.gov.my/wpkl/index.php/ms/component/content/article/200-peningkatkan-sistem-perparitan-di-lembah-klang>
- Khairul Anuar Mohamad and Norhan Abd. Rahman (2008). Kajian ciri-ciri hidraulik dan alam sekitar terhadap perangkap sampah di UTM, Skudai, Johor Bahru. Fakulti Kejuruteraan Awam, Universiti Teknologi Mara.
- Mohd Khidir Zakaria (2020), Longkang tersumbat punca banjir kilat. Harian Metro 5 Jun 2020 <https://www.hmetro.com.my/mutakhir/2020/06/592117/longkang-tersumbat-punca-banjir-kilat>
- Mohd Najmie Bin Mohd (2007). Kajian Tahap Keberkesanan Struktur Perangkap Sampah. Universiti Teknologi Malaysia.

PREGNAMIX; RECIPE FOR BREEDING IN RUMINANTS

Raja Ili Airina R.K

Faculty of Agro-Based Industry, University Malaysia Kelantan Jeli Campus, Jeli, 17600, Kelantan, Malaysia
airina@umk.edu.my

**M S Nazhiifah Amiirah, Abu Bakar K.N., Mohamad Azlan, S.S.,
Z Suhana, Nor M. M and T H S T Abu Bakar.**

Faculty of Agro-Based Industry, University Malaysia Kelantan Jeli Campus, Jeli, 17600, Kelantan, Malaysia
amierasuhaimi97@gmail.com, kyraniesa@gmail.com, sitisarah168@yahoo.com, suhana@umk.edu.my,
maryana_mn@umk.edu, halimatun@umk.edu.my

Highlights: In 2019, a total of 802,798 cattle and goats were registered in Malaysia. However, the country imported approximately RM3 billion worth of meat since 2015, and the number is still increasing. Animal Breeding Policy 2013 pointed out that poor livestock productivity and poor breeding structure were the main challenges. Breeding commences with estrus synchronisation, where hormone regime in animals is possible. However, hormones such as Controlled Internal Drug Release (CIDR) is costly. Alternatively, the utilisation of herbs also manages to synchronise estrus in animals. Pregnamix, a combination of herbs enables structured breeding and optimise productivity because it is cost-effective and practical compared to the utilisation of expensive hormones. With the structured breeding plan, births during the monsoon season that leads to high mortality rates can be avoided. Plus, the forecast on farm productivity can be estimated. Pregnamix grasped the Quadruple Helix Model of innovation because it was proven effective in the field with scientific data, coherent to the Animal Breeding Policy 2013, combine endocrinology and farm management in education and bring new innovation for farmers and the community.

Key words: *estrus synchronisation, structured breeding, ruminant, breeding plan, herbs, CIDR*

Introduction

Self-sufficiency level (SSL) for beef and goats in 2019 was 22.49% and 10.5%, respectively (1). Currently, Malaysia is importing more than 80% of meat for local demand. To tackle this problem, the government constructed Animal Breeding Policy 2013. The policy states that limitations and challenges in the livestock industry are poor productivity, unstructured breeding and lack of technological application among farmers (2). In order to solve the problem, an integrated structured breeding module with Good Animal handling Practices (GAHP) should be introduced in the breeding policy. Structured breeding requires estrus synchronisation, but the cost for hormonal regimes that are available commercially are too expensive and impractical. Thus, natural herb supplements act as an alternative that is safe and cost-effective for estrus synchronisation.

Pregnamix will be able to help breeders plan breeding on the farm. Breeders can plan 5 births in 2 years without affecting the performance of females. When breeding is planned, management for pregnant females and preparations for birth can be arranged. In terms of productivity, farmers are able to anticipate the number of births as well as profits and sales that can be done in future.

Description of PregnaMix

Pregnamix contains a mixture of herbs common in Malaysia, such as *Cinnamomum Verum*, *Zingiber officinale* and *Piper nigrum L.* Studies reported that these herbs have nutritional values in health, but little looked into effect on fertility (3). Studies have shown that Pregnamix showed the same efficacy on estrus synchronisation compared to the expensive hormone, CIDR (Fig.1) The study was conducted in mixed breed goats in two different locations (4). Pregnamix only requires 4 steps.

Step 1: A total of at least 3 healthy non-pregnant females are separated in a pen. Body condition score for females are preferred to be 3 or above.

Step 2: Pregnamix is added in warm water and fed orally to the goat and cow using a syringe (5 ml and 10 ml each, respectively).

Step 3: Observe estrus sign in female for 3 consecutive days.

Step 4: Introduce male to estrus female or perform artificial insemination with frozen semen.

Pregnamix can be paired with pregnancy diagnosis using ultrasound or IOT detection for estrus detection. Analysis on the kidding rate and performance of females can also be recorded after utilisation of Pregnamix.

Product background

Estrus synchronisation programmed for livestock animals in Malaysia has ascend popularity of animal husbandry over a few decades, as people slowly realise the significant recognition of estrus synchronisation in animal breeding procedures. Estrus synchronisation programmed comprises various endogenous hormones like progesterone, prostaglandin F2a and complementation with other hormones such as estrogen and Gonadotrophin Releasing hormone (GnRH) (5). Moreover, estrus synchronisation implied in female livestock animals in return lead to improve

production efficiency by manipulating the estrus cycle or induction of animals. Furthermore, the estrus synchronisation promised a large percentage of the group of female heat at a short, predetermined time instead of females being bred over a 21-day estrus. The most synchronization tool is CIDR. CIDR is an intra vaginal consist of progesterone inserted that practical on livestock which control the progesterone release. CIDR is commercially available, however, the cost is too expensive for local farmers. Thus, Pregnamix offers an alternative to estrus synchronisation.

Why are they important to education?

The product gave an insight on fundamental breeding system in ruminant. This supports the quadruple helix model whereby; the product empowers the farmers through understanding in breeding management. Animal will express estrus every 21 days. Only during estrus, mating or insemination will be successful. Estrus can be induced by hormonal regimes but the cost is high and requires skilled technician. Thus, Pregnamix enable community to enhance learning experience in education by combining endocrinology, animal physiology and farming management. Synchronisation of estrus using Pregnamix is integral in breeding and later can be equipped with other technologies such as artificial insemination, pregnancy diagnosis and heat detection using IOT system.

Advantages of Pregnamix towards education and community.

Pregnamix covers the Quadruple Helix Model where the community will benefit from utilisation of the product. The product enables community empowerment especially small-scale farmers in structuring their breeding program. Pregnamix is easy to use, cost-effective and safe for the animals and environment. Other than that, awareness on structured breeding would then lead to introduction of Agriculture 4.0 where farmers could apply IOT system in heat detection.

Commercial value in terms of marketability or profitability for Pregnamix

Pregnamix played important role in meat industry In Malaysia. Meat demand is expected to increase from 1.4 million tonnes in 2010 to 1.8 million tonnes in 2020 with a growth of 2.4% per annum (1). Plus, the State Government of Kelantan, projected NAIMbif program (commercialisation of meat from high quality beef cattle) to expand meat industry until 2040. Pregnamix targeted farmers registered under NAIMbif under strategic breeding programs and Training and guidance for entrepreneurs NAIMbif that starts from 2021 to 2040. Recently, Kelantan reported to have 52,548 cattle from 2017-2019 from the program (6).

Figure 1: The comparative efficacy of estrus synchronisation between the treatment of CIDR and PregnaMix

References

Dasar Agromak
Animal Breeding
Mekuriya, W., &
Science &
Nur Nazhiifah Ar
between
Science, &
Islam, R. (2011).
NAIMBif Penjang
Teknologi

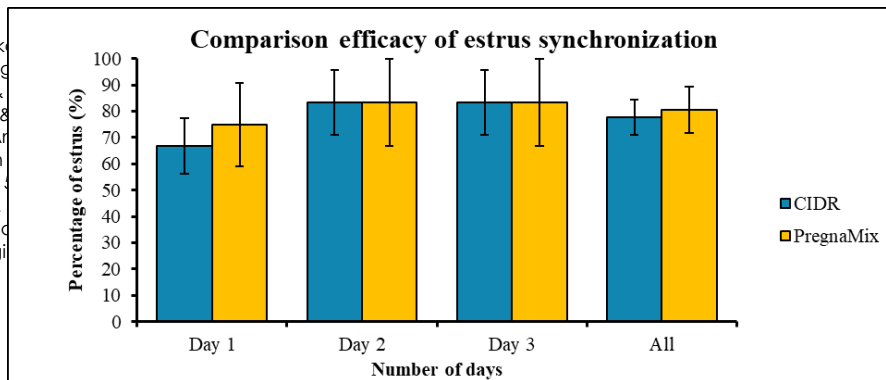

s 2011.
al of Veterinary
synchronisation
d Environmental
teknologi,

HEALTH CHIPS

Puan Fadilah Hanim Aryani Binti Abdullah

Universiti Malaysia Kelantan
aryani.a@umk.edu.my

**Kasthuri A/P S Visvanathan, Kaushilia A/P Haridash, Keerthana A/P Kalangan, Kirthana Makendran,
Rajtheeban A/L Muthuraman, Suganthi A/P Muniandy**

Universiti Malaysia Kelantan

, kasthuri.visvanathan4172@gmail.com, kaushilia.h18a0162@siswa.umk.edu.my, thana.h18a0164@siswa.umk.edu.my,
kirthana.h18a0172@siswa.umk.edu.my, rajtheeban.h18a0531@gmail.com, suganthi.h18a0614@siswa.umk.edu.my.,

Highlights: Potato chips are the most mainstream nibble devoured particularly by everybody. These chips are considered undesirable because of significant degrees of fat and salt substance. Bigger portions are demonstrated unfortunate and will rapidly prompt weight acquisition most likely in movement control order time. This study was conducted to produce healthy chips from apple and carrot and enhance the nutritional value of chips. The results show that it is feasible offering healthful other options and normally likely utilitarian food. Convincingly sound chips can be arranged effectively from every potato, carrot just as apple as a nutritious nibble to everybody experiencing putting on weight.

Key words: *Health chips, apple, carrot, peel*

Introduction

Environmental sustainability is an essential component of global policies designed to meet the demands of future generations (Qureshi et al., 2019). Food loss and waste are common in plant and animal foods throughout the food supply chain. Trimmings, peelings, stalks, seeds, roots, bones, shells, and ligneous components from various food sectors such as sugar, oil, starch, and juice are all included in food waste (Falcone & Imbert, 2017). Food waste management consists of waste avoidance, reuse, recycling, and disposal. By-product usage must be encouraged by this waste management strategy to avoid food waste. Making fruit and vegetable peel chips is an excellent method to divert food waste from the trash. They also keep them from ending up in a landfill, where they will certainly emit methane, exacerbating the problem of climate change. With about fifteen minutes, some oil, and a few spices, one can turn to produce waste into a snack that both humans and the environment will embrace.

Description of the innovation product development

Authors intend to provide nutritious chips to society in response to the decline of consumption of fruits and vegetables. This product will be made from culinary waste, such as apple and carrot peels. This waste contains several strong vitamins that are beneficial to humans. This product might well be manufactured at a lower cost.

The context of the innovation

Many youngsters throughout the world do not reach official recommendations for daily fruit and vegetable consumption. According to a recently published WHO/FAO report, a minimum of 400g of fruit and vegetables per day (excluding potatoes and other starchy tubers) is recommended for the prevention of chronic diseases such as heart disease, cancer, diabetes, and obesity, as well as the prevention and alleviation of several micronutrient deficiencies. Food waste is one of the most difficult problems that humanity is now experiencing on a global scale. Food systems are now exceedingly inefficient: it is estimated that one-third to one-half of all food produced is wasted before reaching a human mouth. It also involves a broader objective of reducing food losses along with food supply systems.

Why are they important to education?

According to U.S. Snack food industry statistics about 86 percent of people consuming salty snacks, followed by 64 percent regularly purchasing the snacks as desserts. Undoubtedly, the statistics state that students consume more snacks. It brings a huge bad effect to students when consuming snacks, especially salty snacks. Here, as an innovation, students can be consuming health chips. The health chip contains apples and carrots peel. These health chips will give more benefit to student's education. Well-timed snacks help control the student's hunger, supply fuel, and boost nutrition. When the selection is left up to students, they often choose sweet, less healthy snacks to munch on during school time. Making snacks at home to take to school is the best way to manage the snacks students eat while away from home. Healthy snacking improves students' mental and physical well-being, and fruit excels in this category as well. According to the findings of a study published in the journal *Frontiers in Nutrition* in 2014, snacking on fruit reduces anxiety, enhances mood, and reduces emotional discomfort. Healthy snacking provides students' brain with the nutrients it needs, and missing out on healthy snacks can negatively affect school performance. The youngest have higher nutrient demands than adults, to support their healthy bone growth and brain development.

The absence of snacks at education places or choosing unhealthy items to snack on can have a major impact on various aspects of the student's health. Students need a steady supply of nutrients to fuel their bodies and brains so that they grow and develop properly. It's recommended that students have at least two nutritious snacks each day.

Advantages of the innovation

These healthy chips give various benefits towards education and community, especially for individuals who want to be fit and healthy. These chips increased sustained energy towards the community. These bites can be beneficial in an eating routine. It can expand supplement consumption, support energy levels, assist the body with recuperating activity and give people a lot of solid alternatives. Certain tidbits can help improve the nature of an eating routine. The community regularly considers smart dieting consuming fewer calories. Eating these sound chips is about equilibrium and ensuring that body is getting the important supplements it needs to work appropriately. Sound Fruit Peel Chips necessitate that the community eats leafy foods, proteins, and starches. One of the principal reasons the community eats a sound eating regimen is to keep a solid weight or to shed pounds. These chips keep up a solid load on individuals and have plenty of advantages all alone. These chips contain carrots which are useful for an individual's eye and may see that a ton of old people use false teeth to eat and talk appropriately. These chips can help the community ensure they have solid teeth and bones now. Education-wise, people get to know what the nutritional contents were used in Fruit Peel Chips. It also helps future generations to get along and produce healthy snacks on maintaining good health and a fit lifestyle.

Commercial value in terms of marketability or profitability of innovation

At this point, a product improvement will hand the reins over to advertising and marketing for a product launch which is also called commercial value. For our product, we determine the price of our product as value-based pricing. Value-based pricing is setting a price based on how much the customer believes with products that selling is worth. We produce this product for all types of consumers even though they are in low-income categories. Next is we are using advertising plans such as posters and videos of our products. This plan can deliver our messages to our target consumers. Finally, we use communication plans such as social media and magazines to promote our product. This plan can help to give major benefits including setting and managing expectations from consumers.

Acknowledgement

In performing our products, we had to take the help and guideline of some respected persons, who deserve our greatest gratitude. The completion of this assignment gives us much pleasure. We would like to show our gratitude to Puan Fadilah Hanim Aryani Binti Abdullah and Dr. Siti Fatimah Bt Ab. Ghaffar for giving us a good guideline for assignments throughout numerous consultations. We would also like to expand our deepest gratitude to all those who have directly and indirectly guided us in writing this assignment.

References

- Falcone, P. M., & Imbert, E. (2017). Bringing a sharing economy approach into the food sector: The potential of food sharing for reducing food waste. *Food Waste Reduction and Valorisation*, 197–214. https://doi.org/10.1007/978-3-319-50088-1_10
- Fulgoni III, V., & Drewnowski, A. (2019). An economic gap between the recommended healthy food patterns and existing diets of minority groups in the US National Health and Nutrition Examination Survey 2013–14. *Frontiers in nutrition*, 6, 37.
- Hanif, M., Hesam, N. M., Akhbar, A., Fazril, I., Zamri, M. F. M. A., & Shamsuddin, A. H. (2020, April). Economic feasibility of smart city power generation from biogas produced by food waste in Malaysia via techno-economic analysis. In *IOP Conference Series: Earth and Environmental Science* (Vol. 476, No. 1, p. 012076). IOP Publishing.
- Qureshi, M. I., Qayyum, S., Nassani, A. A., Aldakhil, A. M., Abro, M. M. Q., & Zaman, K. (2019). Management of various socioeconomic factors under the United Nations sustainable development agenda. *Resources Policy*, 64, 101515. <https://doi.org/10.1016/j.resourpol.2019.101515>
- Selamat, R., Raib, J., Abdul Aziz, N. A., Zulkafly, N., Ismail, A. N., W Mohamad, W. N. A., ... & Mokhtar, A. H. (2020). Dietary practices and meal patterns among overweight and obese school children in Malaysia: baseline data from a school-based intervention study. *Ecology of food and nutrition*, 59(3), 263-278.

IoT IRRIGATION MONITORING AND CONTROL SYSTEM

Aziz Mamat

Politeknik Kota Bharu, Kota Bharu, Kelantan
aziz@pkb.edu.my

Wan Muhammad Amirul Asyraf Bin Azhar, Wan Siti Zulaikha Bt Wan Azhar

Politeknik Kota Bharu, Kota Bharu, Kelantan
Email address
asyrafhani111@gmail.com, wansitizulaikha99@gmail.com

Highlights: This project is about an application of the plant irrigation system. From an observation, the plant irrigation system for the small holder in Malaysia mostly based on the manual way in the plant irrigation system. The project objectives are to produce an engineering device and test the project in order to overcome plants irrigation system problems. In addition, there are several scopes of studies that have been defined for this project, which is the development of a more systematic system that can read the data contained in the plant is soil moisture content, surroundings temperature, and humidity in the air. The device was developed to resolve some problems arising with the use of existing plant irrigation systems. Materials for this project was built to have distinctive features that was controlled automatically as suggested in the literature study. The use of an ESP32 Arduino system is suitable for IOT programming together with the sensors (DHT11 and Capacitive Soil Moisture Sensor). The results of the entire project was successfully generated. The threshold of 60% soil moisture content was used to activate the pump. Based on this result, the conclusion can be made that the IOT Irrigation Control System has reached the objectives discussed. In addition, the development of the IOT Irrigation control system was also proven to save the irrigation time and less labour in crop production than the system before. The advantage of this project, the user will get the data at the fingertips without monitoring their crops manually to get the data. Furthermore, each of these data can be accessed via a smartphone using the application specified to connect with the system.

Key words: IOT, IOT Irrigation control system, Arduino, smartphone

Introduction

Generally, in Malaysia, an agriculture practice was depends on the monsoons which have not enough water source for the whole year. To overcome this problem, the irrigation system is employed in the field of agriculture (El-Pro-Cus (2020). In this system, based on the soil type, the water will be provided to the agricultural field. In agriculture, there are two things, namely, the moisture content of the soil as well as the fertility of the soil (Arun et. al., 2012). At the present time, there are several types of techniques available for irrigation to reduce the dependency on the rain. This type of technique is driven by on/off schedule using electrical power. This project discusses on the implementation of an Irrigation Control System using The Internet of Things (IoT) (El-Pro-Cus (2020). The IoT is a technology where the mobile device can be used to monitor the function of a device. IoT is concerned with interconnecting communicating objects that are installed at different locations that are possibly distant from each other (Aziz et. al., 2008). Internet of Things (IoT) is a type of network technology (Nail et. al., 20018), which senses the information from different sensors and makes anything to join the Internet to exchange information. It can also be used to modify the status of the device. The central processing unit will also include communication device to receive data from the sensors and to be relayed to the user's device. This will be done using a higher communication device such as a Wi-Fi module. The data processed by the central module is converted to meaningful data and relayed to the user. The user can view the data with the help of a handheld device such as a mobile phone or a tablet.

The Development of the IoT and Smart Irrigation Control System

Nowadays water scarcity is a big concern for farming. This project helps the farmers to irrigate the farmland in an efficient manner with automated irrigation system based on soil moisture. The proposed system has been designed to overcome the unnecessary water flow into the agricultural lands. Temperature, moisture, and humidity readings are continuously monitored by using temperature, moisture and humidity sensor and send these values to the assigned IP address. Android application continuously collects the data from that assigned IP address. Once the soil moisture values are exceeded the particular limit then the relay, which is connected to the arduino microcontroller controls the motor. The android application is a simple menu driven application, with 4 options. This includes motor status, moisture, temperature and humidity values. The motor status indicates the current status of the pump. Both IoT and smart irrigation control system were using various sensors such as soil moisture and DHT11 and Capacitive Soil Moisture sensor were connected to the input pins of the Arduino microcontroller. The sensed values from the sensors are displayed in LCD. If the sensed value goes beyond the threshold values set in the program, the pump will be automatically switched ON / OFF by the relay circuit and it is connected to the driver circuit which

helps to switch the voltage. The farmer will be intimated about the current field condition through WIFI module and also updated on the web page. By using this system, the farmer can access the details about the condition of the field anywhere at any time.

Project Application and Result

The project was run under small scale crop. The ESP32 controller was used in this project. The controller was equipped with the DHT11 Temperature and relative Humidity sensor and Capacitive Soil Moisture sensor. The controller also was attached the water pump to irrigate the plant. For the purpose of the instant monitoring, the controller was also being provided with LCD screen Monitor. The programming was done by using the Arduino IDE and the Blynk program for the mobile phone widget. The programming was done to monitoring the soil moisture content, air temperature and the relative humidity. The threshold values was set at 60% soil moisture content. If the Soil moisture content below the threshold value (below 60%) the pump will be "ON" and if the soil moisture content equal or above the threshold value (more than 60%) the pump will be "OFF".

Figure 1 shows the result through the mobile phone. There are two monitoring mode was display. The first mode using graphic and the monitoring proses was recorded continuously according the period of time needed. The second mode was in term of instant figure for the temperature, humidity and soil moisture content. The pump activation can be seen clearly in figure 1. The pump condition in the state of "Pump ON" according to soil moisture content below 60% and changed to "Pump OFF" when the soil moisture content reach 60%.

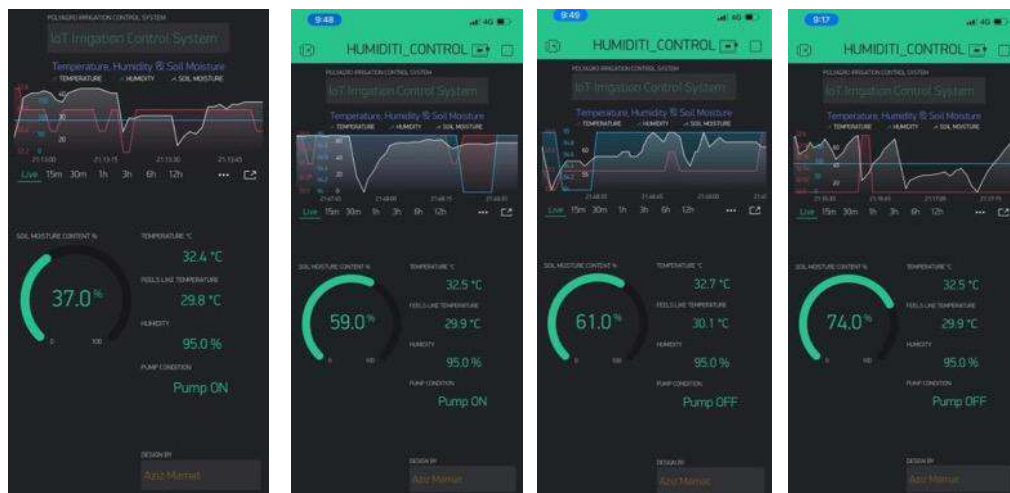

Figure 1: Soil Moisture Content Controlling the Pump activation at 60% threshold (View from Mobile phone)

Conclusion

This project was successful developed and tested. Even though there were a lot of projects can be found in the internet but this prototype project was based on the local condition. From the result, the user especially farmer easily will be able to monitor their farm at their fingertips. This prototype consider small in term of size and also in term of cost. Commercialization of this project is a good step to be made, but several touch-up must be done. In order to make this project as closed as the industrial commercial product.

References

- Arun C., K. Lakshmi Sudha (2012). "Agricultural Management using Wireless Sensor Networks – A Survey" 2nd International Conference on Environment Science and Biotechnology IPCBEE vol.48 (2012) © (2012) IACSIT Press, Singapore 2012.
- Aziz I. A., Hasan M. H., Ismail J. M., Mehat M., and Haron N. S. (2008). "Remote Monitoring in Agricultural Greenhouse Using Wireless Sensor and Short Message Service (SMS)", 2008.
- Bradley J., Barbier J., & Handler D. (2014) : Available online at: http://www.cisco.com/web/about/ac79/docs/innov/loE_Economy.pdf consulted on February 2014.
- El-Pro-Cus (2020). 3 Ways to Automatic Plan Irrigation System using Microcontroller. <https://www.elprocus.com/microcontroller-based-automatic-irrigation-system/>
- El-Pro-Cus (2020). Automatic Solar Submersible Pump Control for Irrigation <https://www.elprocus.com/solar-powered-automatic-irrigation-system/>
- Naik, P., Kumb, A., Katti, K., & Telkar, N. (2018). Automation of Irrigation System Using Iot. International Journal of Engineering and Manufacturing Science. Research India Publications. ISSN 2249-3115 Volume 8, Number 1 (2018) pp. 77-88. <http://www.ripublication.com>

SUITABILITY OF VEGETATION INDICES METHOD IN DETERMINING THE COCONUT TREE STRESS

Faris Alias

Universiti Malaysia Kelantan, Jeli, Kelantan
farisalias13@gmail.com

Wani Sofia Udin

Universiti Malaysia Kelantan, Jeli, Kelantan
wanisofia@umk.edu.my

Highlights: This research is to identify the growth development of coconut trees in plantation farm in University Technology Mara (UiTM) Arau branch using high spatial resolution Remote Sensing image technology. Such trees affected by diseases such as basal red ganoderma and palm weevil (RPW) were detected and map. An innovation have been employed in terms of providing accurate and effective estimates of the health status of coconut trees; distinguishes healthy and diseased plants from aerial hypersensitivity imaging. To that end, several agricultural plant index vegetation indices analyses have been used with their specifications.

Key words: *Coconut palm, tree stress, vegetation indices, remote sensing, sentinel 2A, Normalized Differenced Vegetation Index (NDVI)*

Introduction

Remote satellite sensing data is a great source of information about our environment, provided that it can be interpreted sufficiently. Remote sensing is one of the technologies for the processing of images. The physical character of the object is determined by remote sensing by measuring the transmitted energy type; sent or reflected from an object. Remote sensing was used in many areas, such as meteorological analysis, vegetation, investigation and prevention of geological and military disasters. Based on Bacour's study, plants have a significant influence on the energy exchange between the atmosphere and the earth's surface, as it is the fundamental element of the ground (Bacour et al, 2002). Remote sensing was recognized as a reliable method for predicting different biochemical and biophysical variables of plants (Cohen et al, 2003). In agricultural management, although indirectly used, the first remote sensing report began with Kellogg's mapping of ground resources from aerial photography in 1929. The remote sensing is likely for coconut tree plantations with improved quality and remote sensing availability when coconut tree becomes the most important commodity crop in Malaysia.

Satellite imageries of Sentinel-2 were used to identify the area of coconut tree and how spectral reflectance of fronds that being infested by pests towards the coconut tree. The identifying and classifying the area coconut tree stress was proven using supervised classification. After that, the accuracy of Ratio Vegetation Index (RVI), Vegetation Difference Index (DVI), Green Crop Index (GVI), Root Square (Infrared / Red), Reformalized Different Crop Index (RDVI and NDVI was analysed using confusion error or matrix method between digital number (DN) and the VI value. At the end, the comparison using RVI, DVI, SQRT (IR/R), GVI, RDVI, NDVI and census data (severity level of symptoms) of coconut tree were made (Pohl et al., 2015).

Content

The evaluation in research method is the use of plant indices such as RVI, DVI, SQRT, GVI, RDVI and NDVI can accurately determine the condition of coconut trees on a large scale by using multispectral image. As a result, all these methods usually show better results, as they can give an accuracy between 30% and 71% especially using the NDVI method because of the total accuracy is 91%. The NDVI method is more effective when attacking RPW - infected coconut trees when compared to others including the Multitemporal image UAV method that is familiar in the market. This is because the high resolution image features present on the Sentinel-2A cause the output of DN data from the RGB image can be realized at the maximum level. This research suitable study in the field of agriculture for monitoring the level of tree health on a large scale with analysis to determine the rate of coconut tree tress of high accuracy. In addition, this study can also help in predicting tree growth from time to time especially the insect attack season. In the future, this research is seen to have a high market in facing the country's commodity agriculture revolution in line with the Industrial Revolution (IR 4.0) especially in planning or management of crops in strategic plantations (not limited to coconut trees only).

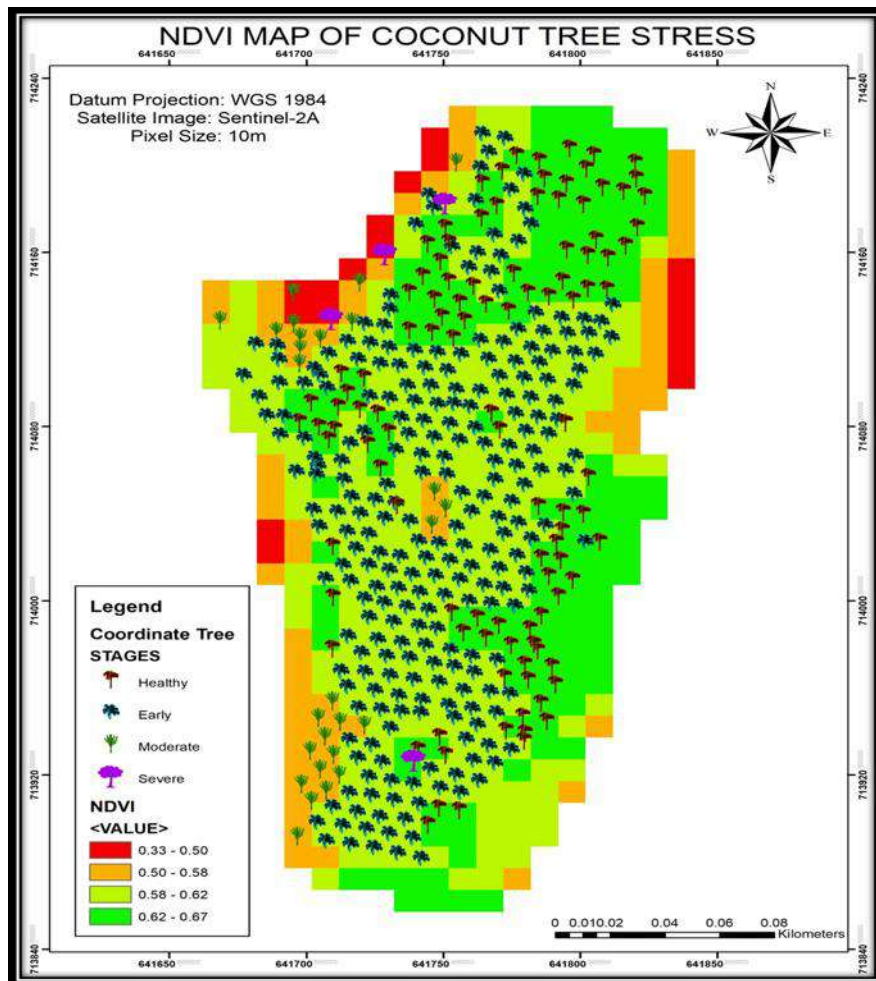

Figure 1: NDVI Indices Map of coconut tree stress Agriculture Farm at Uitm Arau.

Acknowledgement

Special thanks to Ministry of Higher Education and Universiti Malaysia Kelantan for providing grant, facilities, and support for this research. This research is supported by Fundamental Research Grant Scheme (FRGS 2020/1) (R/FRGS/A0800/00433A/002/2020/00886).

References

- Bacour, Hua Jun-Tang, & Ke Liu (2002). Estimating The Crop Leaf Area Index Using Hyperspectral Remote Sensing. *Journal of Integrative Agriculture*, 15(2), 475–491.
- Pohl, C, Loong, C. K., & van Genderen, J. (2015). Multisensor Approach To Oil Palm Plantation Monitoring Using Data Fusion And GIS. (January).
- Chemura, A., van Duren, I., & van Leeuwen, L. M. (2015). Determination Of The Age Of Oil Palm From Crown Projection Area Detected From Worldview-2 Multispectral Remote Sensing Data: The Case Of Ejisu-Juaben District, Ghana. *ISPRS Journal of Photogrammetry and Remote Sensing*, 100, 118–127.
- Cohen et al. (2003). *Remote Sensing: Ecology*. *Progress in Physical Geography*, 29(1), 104–113.

**GREENTECH PEDUNCUBE MADE FROM *CUCURBITA* SPP.,
BANANA PEDUNCLE & *BENINCASA HISPIDA***

Mohamad Khairullah Bin Atan
MRSM Jeli, Kelantan, Malaysia
mrsmjeliinnovaton@gmail.com

Amni Balqis Bt Zurkurnai, Nuraina Nafessa Bt Abdul Hakim
MRSM Jeli, Kelantan, Malaysia
amnibz@gmail.com, nurainanafeesa1234@gmail.com

Highlights: Greentech PedunCube (PCB) is made from banana peduncle fibre, pumpkin starch and wax gourd peels. The objective of the research is to produce a biodegradable material as a substitute to end plastic pollution caused by petroleum-based plastic. The outcome of the research, we have devised Green Procedure to produce PCB. It was produced by mixing all the ingredients based on ratio E24(30:2:5:40) [pumpkin starch: banana peduncle fibre: glycerine: water]. The produced BPCB has been tested for its biodegradability in water and soil. It also tested for its tensile strength, water absorption and effects of heat and burning. Our PCB is ready to replace petroleum-based plastics because it is compostable and environmentally friendly.

Key words: *Biodegradable, Wax gourd, Pumpkin, Fiber, Green Procedure, PCB*

Problem Statement

It is evident that environmental pollution is mainly caused by undecomposed plastic-based products. Plastics are mostly made of undecomposed materials of petroleum fractional distillation such naphthene. Estimates showed that naphthene took around 400 to 1000 years to decompose. Researchers indicated that only 9% of 6.3 billion tons of plastic are recycled and an estimated 8 million metric tons of plastic waste entered the water system. Further, plastics-based materials are found to have substantial contributions towards major pollution. Hence, producing biodegradable composite plastics from renewable substances is crucial to protect and sustain our environment. Besides that, countries richly endowed with natural resources have the potential to derive significant product innovation from resources. For instance, most biodegradable plastics-based products in the market were made accessible within our environment.

Methodology

The research describes the innovation of biodegradable plastics or Greentech Biocomposite Plastic (BPCB). BPCB was made from banana peduncle fiber, pumpkin starch and wax gourd skin which is deemed as the most obtainable resource. The production of this material was also inspired by the dire need to solve the plastic pollution crisis nowadays. Our BPCB used a procedure that are devised by HTW Alexanders called Green Procedure. It has been tested for its biodegradability in water and soil, tensile strength, water absorption and effects of heat and burning. It is urged that BPCB is ready to replace petroleum-based plastics. This research is part of green technology initiatives for varieties of environmentally products.



Figure 1

The Importance of The Research In Education

Product innovation is important for education for many reasons. Firstly, product innovation necessitates students and teachers to search different ways of looking at problems or opportunities and therefore solving them. Within the context of this research, BPCB exposes students and teachers with innovation processes or procedures such as materials or substances, technology, tools and barriers or constraints. In fact, participating students in innovation has a great impact on the education system because it encourages students to use a higher level of thinking to solve complex problems. It is widely accepted that product innovations improve teaching and learning theory and practices as well as on the parents, community, society and its culture.

Advantages Of PedunCube

The main advantage of PCB is a semi-composite plastic made from banana peduncle fiber, Benincasa Hispida and Cucurbita spp. [pumpkin starch]. Since it used renewable sources, PCB is widely accepted as an

environmentally based product. It is proposed that PCB can reduce production cost. Another advantage is to produce eating utensils such as straws and degradable plastics. PCB can also decompose faster than petroleum-based plastics. Other than that, PCB helps to stabilize and increase the incomes of locals' farmers and villages. It is known that PCB is made from organic materials such as pumpkins starch which is found abundant in the rural communities. Our BPCB also has a huge potential to be exported internationally. Nowadays, most countries around the world have placed great demand on biocomposite plastics products. Therefore, this will help to boost Malaysia's economic status.

Marketability Of PedunCube

In terms of marketability of our product, PedunCube can be shaped into a drinking cup, plate, drinking straw and others. From that, we can commercialize it as a method to educate people to choose environmentally-friendly products as the main objective is to reduce the usage of non-biodegradable material which is harmful to nature and we can increase the awareness of selling Greentech products in the market. On the other hand, our research shows that PedunCube has the potential to be designed into a stylus. Our first prototype of this stylus is labelled as HTWStP-21. This stylus has a very high potential of marketability right after the first design was complete. HTWStP-21 was tested on several touch screen devices and it works 65%. Further research and trials are still ongoing for its function and design.

Experimental Data

Properties	PedunCube E24(30:2:5: 2:40) [starch: fibre: peels: glycerine: water]
Modulus of elasticity (MOE), GPa	26.6
Tensile strength, MPa	166
Water absorption (%)	1.98
Thickness swelling	0.80
DENSITY, g/cm ³	1.27
Biodegradability	4-12 months

Table 1

Acknowledgement

We are truly indebted to many individuals who had guided and helped us throughout the whole journey to complete the projects. Firstly, we are most indebted to MRSM Jeli and the UMK Jeli Campus for providing us a comfortable environment for our experiments and giving us permission to use the latest research facilities. Special thanks to Sir Khairullah for exposing us to this program and briefed us about the flow of the project. We would also like to thank our principal, Mr. Sulaiman, MRSM Jeli's staff and UMK Jeli Campus for their utmost guidance and support. Finally, to our beloved parents, colleagues and friends for their support throughout the study of this project.

References

- Dr. Mohamad Bashree Bin Abu Bakar (2019, March 19) In-Person Interview
 Nik Alnur Auli Binti Nik Yusuf (2019, March 19) In-Person Interview
 Dr. Andi Hermawan (2021, January 28) In-Person Interview
 Muhd Naif Fazirin Mohd Azhar, Kel. (2018). *UPR-CS-NFFE Composite with Ceiba Pentandra*. Pusat Pengembangan, Keusahawanan & Pemajuan Profesional (APEEC) UPM, (2013) (1st Edition). *KUNDUR (Benincasa hispida)*. UPM
 Adnan Asad Karim. (January 2015) *Banana Peduncle Biochar: Characteristics and Adsorption of Hexavalent Chromium from Aqueous Solution*. Retrieved from https://www.researchgate.net/publication/272728572_Banana_Peduncle_Biochar_Characteristic_
 Cristy M. Bueno, (June 2012). *Chemical, Cooking And Sensory Characteristics Of Burger Patties With Different Levels Of Banana Peduncle Powder*. Retrieved from https://www.researchgate.net/figure/Chemical-composition-of-banana-peduncle-powder-used-in-the-study_tbl1_278007928
 G.J.H. Grubben & F. Chigumira Ngwerume. *Cucurbita moschata Duchesne*. Retrieved from <https://www.prota4u.org/database/protav8.asp?g=pe&p=Cucurbita+moschata+Duchesne>
 Khazanah Research Institute. (28 February 2019) *Banana: The World's Most Popular Fruit*. Retrieved from http://www.krinstitute.org/assets/contentMS/img/template/editor/20190228_KRI%20Views%20-%20Food%20Market_Bananas
 Laura Parker. (7 June 2019). *The world's plastic pollution crisis explained*. Retrieved from <https://www.nationalgeographic.com/environment/article/plastic-pollution>
 Manuel Neila Matas. (20 April 2015). *The advantages of bioplastics*. Retrieved from <http://www.theenergyofchange.com/advantages-bioplastics>
 Professor Plastics. (18 July 2018). *Plastics Chemistry: The Science of Plastics*. Retrieved from <https://www.plasticsmakeitpossible.com/about-plastics/faqs/professor-plastics-intro-to-the-chemistry-of-plastics/>
 Somaris E. Quintana. (19 April 2018). *Chemical Composition and Physicochemical Properties of Squash (Cucurbita moschata) Cultivated in Bolivar Department (Colombia)*. Retrieved from <http://www.m-hikari.com/ces/ces2018/ces21-24-2018/p/garciaCES21-24-2018-1>
 Suhaimi. (20 July 2015). *Labu Kuning*. Retrieved from <http://myagri.com.my/2015/07/labu-kuning/>

BAMBOO AS REINFORCEMENT IN CONCRETE

Tengku Suriati Binti Tengku Yusoff

Kota Bharu Polytechnic, Kota Bharu, Malaysia
suriati5226@gmail.com

Highlights: Bamboo has been utilised as a building material since its existence. Bamboo was utilised as reinforcement in rural areas, as well as scaffolding. Concrete is a brittle substance that, due to its low tensile strength, cannot be utilised as a single material in building. This invention made use of the bamboo species *Bambusa Vulgaris*. Bamboo reinforcement measures 9-10mm thick x 50mm diameter x 400mm length. In the current study, 9 concrete cylinder specimens were formed using the design mix (M50) supplied by the British Research Establishment (BRE), as well as implanted lengths of bamboo strip of 50, 100 and 150mm. The bond strength of all specimens was evaluated after 28 days. Each specimen was subjected to a bond test in accordance with the ASTM C900-15 Standard, utilising a 2000 kN Universal Testing Machine (UTM). The study discovered that a V-shape bamboo strip with a 50 mm embedded length can enhance the connection between bamboo and concrete even when the bamboo strips were not treated.

Key words: *Bamboo Strip, Reinforcement, Bond-Slip Interaction*

Introduction

Due to various advantages, replacing steel bars with bamboo can be utilised as an alternative reinforcement in concrete structures. The majority of buildings are made of concrete. Steel is the most often used reinforcing material in concrete. Steel requires a lot of energy to make and cannot be replenished. Some countries do not even have steel. Bamboo is a plant that is easy to grow and easy to locate, particularly in Asia. Bamboo has numerous advantages, one of which is that it has a high enough tensile strength, particularly on the exterior bamboo fibre side or on the bamboo skin. According to Rahman (2011)'s research, bamboo is a viable alternative for reinforcing bar in concrete for low-cost structures. Bamboo is a natural material that is inexpensive, readily available, and, most importantly, strong in both tension and compression.

Product Development, Design and Process

The first step for this method is by doing a compression test for the concrete cube. Concrete cubes test are made in order to determine the characteristic strength of the concrete and achieve the minimum strength which has been specified using grade C50. Next, the preparation of test specimens and testing using the following tools: stirring concrete compression machine with a capacity of 3000 kN to test the compression strength of concrete, Universal Testing Machine (UTM) 2-ton capacity used for pull out test. The material used for normal concrete was cement, sand, coarse aggregate, and water. Specimen test was cube with 100 mm. Concrete cube covered with wet gunny sack for 28 days. Specimen were weighed before test. The specimens were placed in compression testing machine. The load is applied to concrete until the specimen failure. Compression stress is determined at ultimate load.

Lastly, the dimension of bamboo strip is 10mm x 50mm x 400mm. Concrete cylinders of 110 mm diameter and 200 mm length are used for the test. Bamboo reinforcement were inserted at the centre of concrete cylinders for with three various embedded length (50mm, 100 mm and 150 mm) when casted. The sample was tested after 28 days of curing. Figure 1 below shows the typical sectional detail and pull-out test setup.



Figure 1: The typical sectional detail and pull-out test setup

Result

The pull-out test for bamboo reinforcement with three different lengths embedded in concrete cylinders shows the bonding stress. Details of 9 cylinder test and the results are shown in Table 1 below.

Discussion

Calculation of the bond-stress reinforcement of bamboo based on direct bond pull-out shows that the average bond stress on the specimens with *Bambusa vulgaris* as reinforcement in vary embedded lengths shows that the value of bond stress at 50 mm embedded. This is because of the bamboo have more friction between concrete.

Hence, this innovation shows that sing an alternative material such as bamboo as reinforcement in concrete will give a lot of advantages especially to the environment and the user itself since it will reduce the waste material produced and the most important things is bamboo is cheaper in the market. This will give a lot of advantages if it can be widely used in the real world especially in the construction field. Even though by using bamboo as reinforcement in concrete shows the result is not as good as using steel bar, still a good prospect to develop if further detail study on it application is conducted.

References

- Elagroudy, H., (2003). Bond Characteristics Of Micro-Composite Multistructural Formable Steel Used In ReinforcedConcrete Structures. Master of Science Thesis, Civil Engineering, North Carolina State University, USA. <http://www.lib.ncsu.edu/theses/available/etd-7252003-213630/unrestricted/etd.pdf>
- Elagroudy, H., (2003). Bond Characteristics Of Micro-Composite Multistructural Formable Steel Used In Reinforced Fortuna bamboo (2015). Why bamboo. <http://www.fortunabamboo.com/why-bamboo/> (Downloaded 2016-07-21)
- Griebel, D., Hebel, D.E., Heisel, F., Javadian, A., Schleiser, K., Wielopolski, M. (2015). Green steel- constructing alternatives out of bamboo. World bamboo congress. Korea. <http://www.worldbamboo.net/wbcx/Keynotes/KeynoteHebel.pdf> (Downloaded 2016-06-07)
- Masani, N. J., Dhamani, B. C. and Bachan Singh (1977), Studies on Bamboo Concrete Composite Construction.
- Nindyawati, Sri Murni Dewi, Agoes Soehardjono (2013). The Comparison Between Pull-Out Test And Beam Bending Test To The Bond Strength Of Bamboo Reinforcement In Light Weight Concrete. International Journal of Engineering Research and Applications (IJERA) ISSN: 2248-9622 www.ijera.com Vol. 3, Issue 1, pp.1497-1500.
- Rahman, M. M., Rashid, M. H., Hossain, M. A., Hasan, M. T., & Hasan, M. K. (2011). Performance evaluation of bamboo reinforced concrete beam. *Int J Eng Technol*, 11(4), 142-146.

A MATHEMATICAL MODEL DEVELOPED TO PREDICT RESIDENTIAL EXPOSURE TO PESTICIDE VAPOURS EMITTED FROM TREATED FIELDS

Wong Hie Ling

Universiti Malaysia Kelantan, Kelantan, Malaysia
hlwong@umk.edu.my

Shaparas Binti Daliman, Marianne Christie Leong, Sifi Hajar Binti Ya'acob, Muhammad Firdaus Bin Abdul Karim

Universiti Malaysia Kelantan, Kelantan, Malaysia
shaparas@umk.edu.my, marianne@umk.edu.my, hajar.y@umk.edu.my, firdaus.ak@umk.edu.my

Highlights: A mathematical exposure model was developed to assess residents' exposure to pesticide vapours by living nearby the agricultural fields, drawing on the existing established exposure models. The model considers the complex processes of pesticide transfers in the environment, which is useful in supplementing costly and time-consuming field measurements. A validated version can be used as a cost-effective tool in pesticide authorisation and registration process to mitigate pesticide risks in the general public more effectively.

Key words: *resident, pesticide vapour, inhalation, exposure, algorithm, regulatory*

Introduction

In agriculture, pesticides are often heavily applied to kill and control pests and crop diseases. Nevertheless, applied pesticides may be emitted into the atmosphere as pesticide vapours after a spraying activity is completed. The emitted pesticide vapours can be transported to different distances downwind the treated fields, and then get into contact with residents living nearby via respiratory inhalation and indirect dermal contact with pesticide deposits (Wong et al., 2017). Residents typically have no work related to pesticides, but they can be unintentionally exposed to pesticides up to 24 hours per day due to their location, with the highest time-weighted average inhalation exposure to pesticide vapours within 24 hours after spraying and that of default 2 hours of dermal exposure to pesticide deposits in their own lawn (EFSA, 2014). That is, exposure via inhalation route can be more important than dermal route.

Humans' exposure to pesticides via direct and indirect non-dietary routes of exposures (i.e., dermal contact and respiratory inhalation) have been associated with various health effects ranging from acute poisonings to chronic effects. For example, respiratory disorders, coughing, headaches, dizziness, fatigue, reproductive effects and chronic kidney diseases (Sankoh et al, 2016; Elahi et al, 2019). In residents, they can be exposed to pesticides over prolonged period due to the emission of applied pesticides that can occur over several days or weeks after spraying (Scheyer et al., 2007). The inhaled pesticide vapours can be very dangerous because they can be directly dissolved at the lungs' surface and get into the bloodstream (Ogg et al., 2018).

Pesticide exposure is almost always quantified in regulatory risk assessments only. Over time, mathematical exposure models have been evolved as an alternative tool to supplement the limited field data measurements in regulatory risk assessment (Salcedo et al, 2017; Wong & Brown 2020). In a study conducted by Wong et al. (2017), a mathematical exposure model was developed to predict the level of residential exposure to pesticides treated in nearby agricultural fields via both inhalation and indirect dermal exposures. Due to the potential higher risk via inhalation route in residents, we focus on pesticide vapour inhalation in this piece of work.

The developed exposure model for pesticide vapour inhalation consists of three major phases, starting from pesticide emission from treated surfaces (plant and soil surfaces), followed by the atmospheric transport of pesticide vapours at different downwind distances, and lastly the inhalation uptake of pesticide vapours among residents (Figure 1). Four established models were selected to predict residents' exposure to pesticide vapours, namely the Pesticide Emission Assessment at Regional and Local Scales (PEARL; van den Berg & Leistra, 2004) for pesticide emission from plant surface, Pesticide Leaching Model (PELMO; Ferrairi et al, 2005) for pesticide emission from soil surface, Industrial Source Complex Short Term 2 (ISCTCS2; US EPA, 1992) for the transport of pesticide vapours at different downwind distances, and the EFSA Guidance on the assessment of exposure of operators, workers, residents and bystanders in risk assessment for plant protection products (EFSA, 2014) for the systemic inhalation exposure on a daily basis. The present model has a major advantage of its flexibility to predict pesticide exposure at different distances, while other existing models predict the exposure level at fixed downwind distances (e.g., the Bystanders, Residents, Operators and Worker\$ Exposure models for plant protection products predicts the exposure at distances between 2 and 20 m only; Butler Ellis et al., 2013). That is, the present model is adjustable for the specific physicochemical properties of pesticide active substances, local environmental factors and different distances.

Exposure predictive models that can describe the actual exposure scenarios are cost-effective tools in regulatory risk assessment. Overall, the present model can be used to monitor pesticide risk in residents, with model validation against field measurements and further improvements are necessary to increase the level of accuracy.

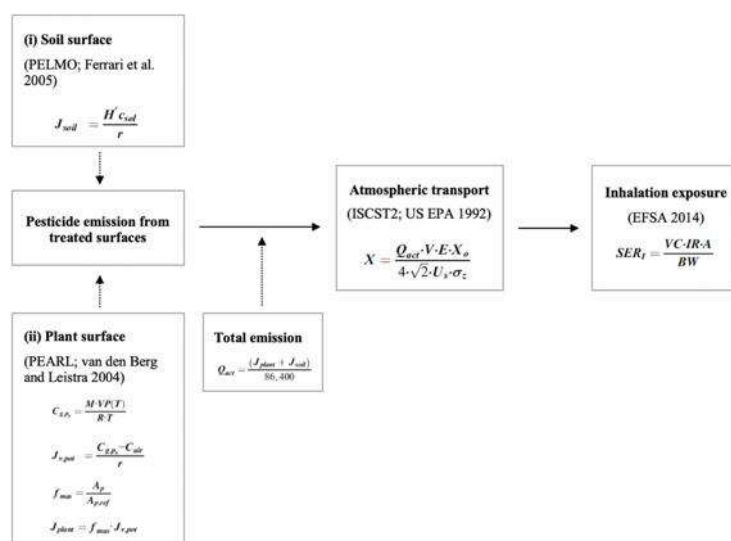

Figure 1. A mathematical model developed to predict residential exposure to pesticide vapours at different distances downwind the treated fields

Acknowledgment

Authors would like to express appreciation to Prof. Colin Brown from the University of York, UK and David Garthwaite and Dr Carmel Ramwell from the Fera Science Ltd. (fera), UK for their support throughout the model development.

References

- Butler Ellis, M. C., van den Berg, E., Kennedy M, et al. (2013) BROWSE: deliverable 3.4. Work package 3: models of exposure to agricultural pesticides for bystanders and residents, supported by the European Union 7th Framework Programme and coordinated by Fera.
- EFSA. (2014). EFSA guidance on the assessment of exposure for operators, workers, residents and bystanders in risk assessment for plant protection product. EFSA J 12(10):3874.
- Elahi, E., Weijum, C., Zhang, H., & Nazeer, M. (2019). Agricultural intensification and damages to human health in relation to agrochemicals: application of artificial intelligence. Land Use Policy 83:461-474.
- Ferrari, F., Klein, M., Capri, E., & Trevisan, M. (2005). Prediction of pesticide volatilisation with PELMO 3.31. Chemosphere 60:705-713.
- Ogg, C. L., Hygnstrom, J. R., Alberts, C. A., & Bauer, E. C. (2018). Managing pesticide poisoning risk and understanding the signs and symptoms. Institute of Agriculture and Natural Resources, University of Nebraska-Lincoln Extension. Retrieved from <https://extensionpublications.unl.edu/assets/pdf/ec2505.pdf>
- Salcedo, R., Vallet, A., Granell, R., Garcera, C., Molto, E., & Chueca, P. (2017). Eulerian-Lagrangian model for the behaviour of droplets produced by an air-assisted sprayer in a citrus orchard. Biosystem Engineering 154:76-91.
- Sankoh, A. I., Whittle, R., Semple, K. T., Jones, K. C., Sweetman, A. J. (2016). An assessment of the impacts of pesticide use on the environment and health of rice farmers in Sierra Leone. Environment International 94:458-466.
- Scheyer, A., Morville, S., Mirabel, P., & Millet, M. (2007) Variability of atmospheric pesticide concentrations between urban and rural areas during intensive pesticide application. Atmospheric Environment 41:3604-3618.
- US EPA (1992) User's guide for the industrial source complex (ISC2) dispersion models. Volume II – description of model algorithms. EPA-450/4-92-008b. Office of Air Quality Planning and Standards, Technical Support Division Research Triangle Park, US Environmental Protection Agency, North Carolina.
- Van den Berg, F., & Leistra, M. (2004). Improvement of the model concept for volatilisation of pesticides from soils and plant surfaces in PEARL. Description and user's guide for PEARL 2(1):1-C1.
- Wong, H. L., Garthwaite, D. G., Ramwell, C. T., & Brown, C. D. (2017). How does exposure to pesticides vary in space and time for residents living near to treated orchards? Environmental Science and Pollution Research 24:26444-26461.
- Wong, H. L. & Brown C. D. (2020). Assessment of occupational exposure to pesticides applied in rice fields in developing countries: a critical review. International Journal of Environmental Science and Technology 18:499-520.

ECO-TROLLEY SHOPPING BAG

Nur Fatimah Binti Ramli

Polytechnic of Kota Bharu, Kota Bharu, Kelantan
fatihahr2104@gmail.com,

Shahirah Binti Aziz, Siti Hawa Binti Kadir

Polytechnic of Kota Bharu, Kota Bharu, Kelantan
shahirahaziz1224@gmail.com, sitihawajka@gmail.com

Highlights: The No Plastic Bag Campaign by the Local Authority (PBT) is implemented in two phases, namely Phase 1, from Dec 2020 to 2021 and Phase 2, from 2022 until 2025 (Siti A'isyah Sukaimi, 2020). In line with this campaign, the Eco-trolley shopping bag is designed as a solution to the extensive use of plastic when shopping. Its design is based on several factors such as recycling, customer friendliness and aesthetic value. Its use is expected to provide awareness to the community about the dangers of plastic waste and cooperate with the government in this campaign.

Key Words: Plastic Bag, shopping bag, design idea, Plastic Waste, campaign.

Introduction

24% of the 19,000 tonnes of solid waste in Malaysia is plastic. As many as 500 million to 5 trillion plastic bags are produced and used each year worldwide. Every year, more than 500 billion plastic bags are used worldwide and only 1% of that is recycled (Bukhari Malek, 2017). Therefore, an approach was taken to support the campaign, raise awareness about the effects of plastic and invite the community to participate through the use of Eco-trolley shopping bags.

Trolleys are built to help reduce manpower consumption when lifting and moving heavy items from one place to another. There are various types of trolleys available in the market such as supermarket trolleys, freight trolleys, gas tank lifting trolleys and others. The disadvantage of this trolley is that it encourages the use of plastic among consumers.

There are various forms of shopping bags in the market to ease consumers when shopping but the disadvantage is the issue of the use of plastic has not been addressed and it is expensive and not user-friendly in Malaysia in particular (Mohd Rafi Mamat, 2019). According to UN Environment Program (UNEP) 50 percent of plastic is used only once and plastic is 10 percent of the waste generated (Prof Dr Ahmad Ismail, 2018).

Based on the trolley and shopping bag facilities available in the market, the design idea of the Eco-trolley shopping bag was implemented. The purpose is to improve the performance of existing trolleys and shopping bags so that the public is more interested in using this product and then responds to the call of the government's campaign in addressing the issue of plastic bags.

Product Development, Design and Process

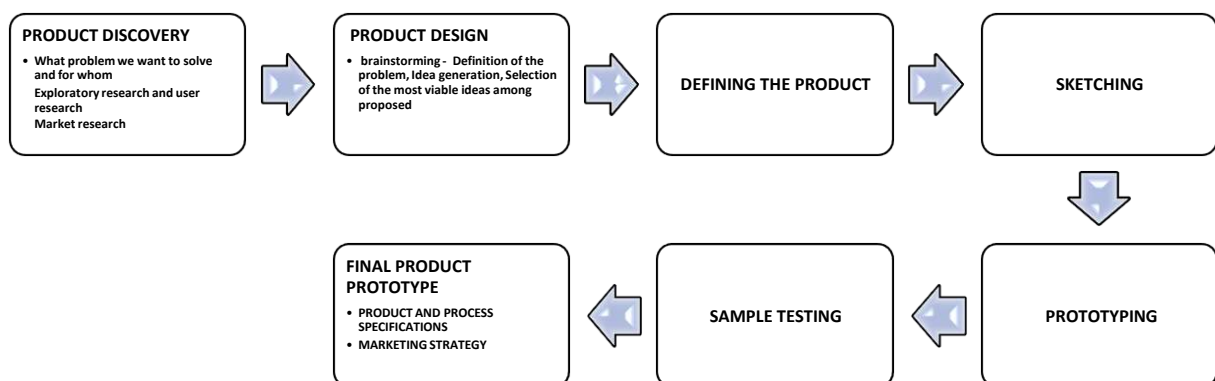

Result



Eco-trolley shopping bags are designed by taking into account the problems faced by consumers nowadays in the issue of the use of plastic bags, the problem of dumping plastic bags and the indifferent attitude of consumers when using trolleys provided by certain parties. The design also takes into account the weaknesses and strengths of existing products in the market.

In addition, the Eco-trolley shopping bags can also be used separately either as a single bag, together with the trolley or combined the single bag into a complete set.

Discussion

The Eco-trolley shopping bag is designed to encourage consumers to support the plastic bag-free day campaign with its design in line with the Malaysian way of life. In addition to the low cost in accordance with the standard of living of most people in this county, the design features used also allow users to use this bag optimally at an affordable price.

Acknowledgement

We would like to thank Kota Bharu Polytechnic, Kelantan for their assistance and technical management as well as space and assets belonging to the institution during the process of conducting this research.

References

- Bukhari Malek (2017, May 23). Ramai Tak Sedar Kesan Buruk Akibat Penggunaan Beg Plastik Termasuk Aku. VOCKET. Retrieved from <https://www.thevocket.com/ramai-tak-sedar-kesan-buruk-akibat-penggunaan-beg-plastik-termasuk-aku/>
- Mohd Rafi Mamat (2019, Jun 19). Masyarakat perlu sedar keburukan guna beg plastik. BH Online. Retrieved from <https://www.bharian.com.my/berita/wilayah/2019/06/575804/masyarakat-perlusedarkeburukan-guna-beg-plastik>
- Prof Dr Ahmad ismail (2018, Jun 5) Pencemaran Plastik Ancam Hidupan Laut. BH online. Retrieved from <https://www.bharian.com.my/rencana/komentar/2018/06/434140/pencemaran-plastikancamhidupan-laut>
- Siti A'isyah Sukaimi (2020, November 19). Penggunaan beg plastik 'diharamkan' di seluruh negara. KOSMO, Media Mulia Sdn Bhd. Retrieved from <https://www.kosmo.com.my/2020/11/19/penggunaan-beg-plastik-diharamkan-di-seluruh-negara/>

SURFACE-ACTIVE AGENT OF NEWLY ISOLATED BACTERIUM, *Pseudomonas sp* DSB7

Ainihayati Abdul Rahim

Faculty of Bioengineering and Technology, Universiti Malaysia Kelantan, 17600 Jeli, Kelantan.
ainihayati@umk.edu.my

Nurazeerah binti Khamis¹, Noor Azlina Ibrahim¹, Khomaizon Abdul Kadir Pahirul Zaman²

¹Faculty of Bioengineering and Technology, Universiti Malaysia Kelantan, 17600 Jeli, Kelantan

²Faculty of Agro Based Industry, Universiti Malaysia Kelantan, 17600 Jeli, Kelantan
nurazeerah@ymail.com-n_azlina@umk.edu.my, khomaizon@umk.edu.my

Highlights: The highlight of this project is a new surface-active agent produced by locally isolated bacterium, *Pseudomonas sp.* DSB7. This surface-active agent or biosurfactant was shown to have a significant surface reduction activity and bioemulsification activity towards hydrocarbons. Biosurfactant has a good potential as a substitution to chemical surfactant since it has the similar activity but with more advantages such as more environmentally friendly and no toxic to living cells.

Key words: Biosurfactant, *Pseudomonas aeruginosa*, hydrocarbon, emulsification

Introduction

Surfactants are amphiphilic organic compounds comprising of non-polar and polar moieties which confer its ability to reduce surface tension of liquid-air interface and interfacial tension of aqueous and non-aqueous phases. These fascinating features allow surfactants to be used as wetting agents, foaming agents, stabilizer, cleaning agents, antimicrobial agents, emulsifier as well as de-emulsifier and have been applied in various industrial applications such as food and beverages, cosmetics and personal care products, laundry detergents, agricultures, pharmaceuticals, medical and health care products, petroleum and petrochemical sectors as well as bioremediation. Despite their important roles in many applications, chemical surfactants also have some disbenefits. Chemical surfactants are reported to be less biodegradable by natural microorganisms and more toxic to microbiota and aquatic life. Some household cleaning formulations and personal care products also contain significant surfactant solution which can caused dermatological problem such as skin irritation. Microbial surface-active agents or biosurfactants are extracellular or intracellular amphiphilic bio-compounds that responsible for reducing surface and interfacial tension of liquid phases. Biosurfactant has been a subject of interest by many scholars due to its fascinating properties such as more compatible with environment, more biodegradable, low in toxicity, and more specificity which meets the requirements towards the development of 'green technology'.

Content

A potent biosurfactant producer named DSB7 was successfully isolated from hydrocarbon-contaminated soil of Sungai Dungun, one of the main rivers located in Terengganu, Malaysia by using Minimal Salt Media (MSM) supplemented with 1% (v/v) of motor oil as an additional carbon source. Based on the 16S rRNA gene sequencing and Neighbour-joining phylogenetic tree, this strain showed the highest sequence similarity (99%) and the closest relatedness with *Pseudomonas aeruginosa*. This strain also presented significant results in all screening assays for biosurfactant production i.e., drop collapse test, surface tension measurement, emulsification index, CTAB methylene blue agar test, and hemolytic test in comparison with Sodium Lauryl Sulfate, SLS (1%), a synthetic surfactant. Further analysis on the natural surface-active agent of isolate DSB7 showed the anionic properties of biosurfactant with surface tension measurement of 38.48 mN/m, and emulsification index of kerosene and used motor oil with the percentage of 53.57% and 30% respectively. FTIR characterization revealed its nature as glycolipid. As the well-known bacterial species that can produce biosurfactant, it was convinced that *Pseudomonas sp.* isolated from this study could be a good candidate to be used in many applications in future. Some of the proposed applications are as bio emulsifier and wetting agent, application in petroleum recovery by *microbial enhanced oil recovery* (MEOR) and application in cosmetic and pharmaceutical industries. Natural surface-active agent has the advantage of possessing all the characteristic owned by synthetic surfactants, but they are more environmentally friendly and non-toxic to living cells.

Acknowledgement

This work is supported by Research Acculturation Research Scheme (RAGS) R/RAGS/A07.00/01106A/001/2015/000192 awarded by the Ministry of Higher Education (MOHE). Authors would like to thank the Faculty of Bioengineering and Technology, Faculty of Agro Based Industry and Universiti Malaysia Kelantan for their support in this research work.

References

- Saharan, B. S., Sahu, R. K., & Sharma, D. (2011). A review on biosurfactants: fermentation, current developments and perspectives. *Genetic Engineering and Biotechnology Journal*, 2011(1), 1-14.
- Cameotra, S.S., Makkar, R.S., Kaur, J. and Mehta, S.K. (2010) Synthesis of biosurfactants and their advantages to microorganisms and mankind. In *Biosurfactants* ed. Sen, R. pp. 261–280. New York: Springer
- Luff, L., Confortin, T. C., Todero, I., Zobot, G. L., & Mazutti, M. A. (2020). An overview of fungal biopolymers: bioemulsifiers and biosurfactants compounds production. *Critical Reviews in Biotechnology*, 40(8), 1059-1080.
- Sharma, V., & Sharma, D. (2018). Microbial Biosurfactants: Future Active Food Ingredients. In *Microbial Bioprospecting for Sustainable Development* (pp. 265-276). Springer, Singapore.
- Lamichhane, S., Krishna, K. C. B., & Sarukkalgige, R. (2017). Surfactant-enhanced remediation of polycyclic aromatic hydrocarbons: A review. *Journal of Environmental Management*, 199, 46–61.

UNDERGROUND WATER TREATMENT SYSTEM FOR PRIMARY SCHOOL USING ECO WATER MEDIA FILTRATION (ECO WMF)

Nik Nurul Anis Nik Yusoff

Faculty of Bioengineering and Technology, Universiti Malaysia Kelantan, Jeli Campus, 17600 Jeli, Kelantan, Malaysia
anis.ny@umk.edu.my

Wan Mohd Faizal Wan Ishak, Nik Raihan Nik Yusoff, Mohamad Najmi Masri, Nabihah Abdullah, Shafini Mohd Shafie

Faculty of Bioengineering and Technology, Universiti Malaysia Kelantan, Jeli Campus, 17600 Jeli, Kelantan, Malaysia
Fakulti Teknologi Kejuruteraan (Kimia), UC TATI Campus, Telok Kalong, 24000 Kemaman, Terengganu, Malaysia
Technology Management, College of Business, Universiti Utara Malaysia, 06010 UUM Sintok, Kedah, Malaysia
wmfaizal.wi@umk.edu.my, nraihan@umk.edu.my, najmi.m@umk.edu.my, nabihah@uctati.edu.my, shafini@uum.edu.my

Highlights: In general, Malaysia has abundance of water source including surface and underground. However, the supply of clean water is decreasing while demand is growing parallel to the increase of total population. The lack of clean water, shortages and contaminated water may affect public health and environment such as diseases outbreak, barren soil, social activities and economy growth interruptions. The underground water treatment system namely ECO water media filter (ECO WMF) is a project to solve the problem face by the community for the domestic uses. Activated carbon of ECO WMF is innovated from low cost materials, palm oil waste, which specifically remove iron ions, repulsive smell and other micropollutants. The design of water treatment system is developing to solve the problem faced by the community in that area generally for drinking, cooking, cleaning and particularly for ablution water (Wudu) as the existing water is yellowish and brown due to the high iron ions. The system that has several stages will mainly treat the high iron content in water and stabilized the pH to suit drinking purposed and washing. The low supply of treated water in Kelantan is the primary reason why this system is developed. The use of alternative water source that is from underground is supposed to lower the cost of water for domestic uses for the long term.

Key words: *ground water, water treatment, iron, water filter, activated carbon, palm oil waste.*

Introduction

The presence of iron in ground water is a direct result of its natural existence in underground rock formations and precipitation water that infiltrates through these formations. Although not considered to cause health problems in humans, its presence in potable water is rather unpleasant due to the bad odours it spreads, its rusty taste and colour, its feel on skin and hair, and its tendency to stain clothing. Most countries have accepted a safe drinking water standard (aesthetic, not health related) with a maximum of 0.3 ppm iron content. Water drawn from sources with higher iron content should be treated before entering any municipal water supply system. At the same time, iron is an essential nutrient for humans, with are commended daily intake of 5 mg. Thus, to circumvent the issue of high content of iron, the new developed treated water system will be employed, by removing iron with oxidation and eco water media filtration innovated from low cost material, palm oil waste. This greatly reduces the energy and operational costs of the entire iron removal process.

Content

As can be seen in Figure 1, underground water intake was being fed to the series of oxidation tank in order to remove dissolved gases (such as carbon dioxide) and oxidizes dissolved metals such as iron, hydrogen sulfide, and volatile organic chemicals (VOCs). Then, the oxidize stream outlet from the Oxidation Tank 3 was pumped using centrifugal pump before being sent to the series of ECO water media filtration (WMF1 and WMF 2). WMF consists of gravel, coarse sand, silica fine sand, zeolite and activated carbon. Activated carbon of ECO WMF was innovated from low cost materials, palm oil waste (POW), to remove the repulsive smell. Clean water tank used to store the treated ECO WMF streams that satisfy the requirement by National Water Quality Standard (NWQS) Malaysia.

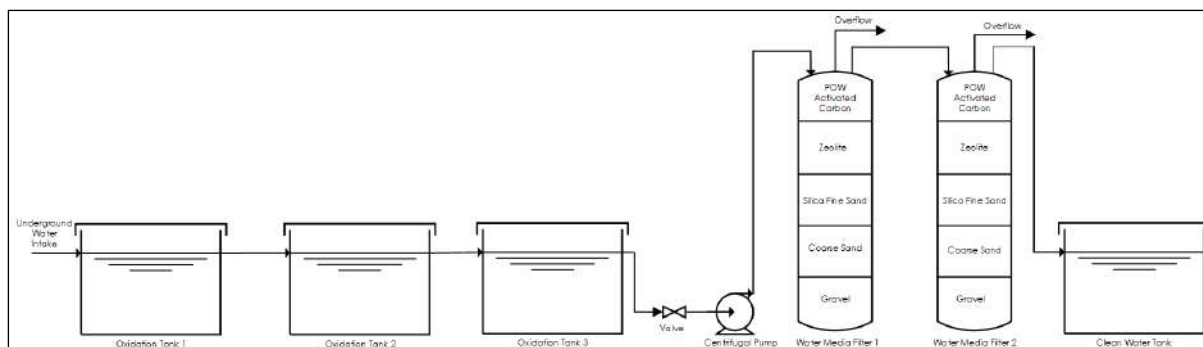

Figure 1: Schematic diagram of water treatment system using ECO WMF

The novelty of water treatment system using ECO WMF is about the method that has been used to utilize oxidation by using three series of oxidation tank. The choice of materials for activated carbon as a filter medium for water treatment system is greatly important since its contribute to the different adsorption capacity of iron ions. Activated carbon of ECO WMF is innovated from low cost materials, palm oil waste, to remove the repulsive smell, particularly iron ion. By passing through both filter materials with water containing Fe ion, the advantage is a removal of up to 100% of both Fe was observed which meet the requirement of NWQS Malaysia, as listed in Table 1.

Table 1: Concentration of the treated underground water with NWQS Malaysia

Metal	Concentration of the treated underground water (mg/l)	Standard value of NWQS (IIA/IIB)
Fe (iron)	0.001	1
Mn	0.181	0.1
Ag	Not detected	0.05
Al	Not detected	-
As	Not detected	0.05
Cd	0.006	0.01
Cu	Not detected	0.02
Ni	Not detected	0.05
Pb	Not detected	0.05
Zn	0.027	5

Water treatment system mainly using ECO WMF is commercially marketable due to the low cost of installation, effective in treating iron ions and remove bad odours. Moreover, the concentration of treated water meets the requirement by NQWS Malaysia.

Through water treatment system mainly using ECO WMF, it has great impact on society, economy and nation in terms of improve the school environment hence increase on the student enrolment in SRI Al Hilal School, enhance knowledge (lifelong learning) in process of treated water system from underground water and recognize by society as UMK can develop technology for society needs. Furthermore, water treatment system is an amazing Sadaqah Jariyah because of the student and staff can perform wudu which is essential part of Salah, drinking, cooking and cleaning with clean water.

Acknowledgement

We are grateful for the financially supported by the Universiti Malaysia Kelantan through grant number R/SIR/A1300/01524A/002/2020/00762

References

- Marsidi, N., Hasan, H.A., & Abdullah, S.R.S. (2018). A Review of Biological Aerated Filters for Iron and Manganese Ions Removal in Water Treatment. *Journal of Water Process Engineering*, 23; 1-12.
- Ukanwa, K.L., Patchigolla, K., Sakrabani, R., & Anthony, E. (2020). Preparation and Characterisation of Activated Carbon from Palm Mixed Waste Treated with Trona Ore. *Molecules*, 25; 5028

VCENDOL: RETORT PROCESS FOR READY-TO-DRINK (RTD) CENDOL

Syamsuriana Sidek

Universiti Malaysia Kelantan, Faculty of Entrepreneurship and Business, Pengkalan Chepa 16100, Kota Bharu,
Kelantan, Malaysia
suriana@umk.edu.my

Tuan Muhammad Muiz T. Nordin, Yusrinadini Zahirah Md. Isa @ Yusuff, Nurul Azwa Mohamed Khadri & Hazrina Hasbolah

Universiti Malaysia Kelantan, Faculty of Entrepreneurship and Business, Pengkalan Chepa 16100, Kota Bharu,
Kelantan, Malaysia
tmmuiz11@gmail.com, yusrinadini@umk.edu.my, azwa.mk@umk.edu.my & hazrina.h@umk.edu.my

Highlights: *Cendol* is a local Malaysian favourite dessert was prepared as per traditional method. It is an iced sweet dessert that contains droplets of green rice flour jelly, coconut milk and palm sugar syrup. *VCendol* innovates the traditional *cendol* in a bowl into a bottle. The main innovation highlighted by *VCendol* is innovation process of retort process for ready-to-drink (RTD) *cendol*. This process is widely used for ready-to-eat (RTE) products, but for RTD especially *cendol* is still under research. Thus, this project attempts to test the development of shelf-stable RTD *cendol* as an alternative for soft drink products using retort process.

Key words: *Retort, retort processing, ready-to-drink, RTD, ready-to-eat, RTE*

Introduction

Versatile Food and Beverage is a start-up venture established in August 2019 with start-up capital of RM1,000. This business is officially registered in June 2020. The founder of Versatile Food and Beverage is Tuan Muhammad Muiz Bin T Nordin, 24 years old, a fourth-year student of Bachelor of Entrepreneurship with Honours at Faculty of Entrepreneurship and Business, Universiti Malaysia Kelantan. He is expected to graduate in this coming September.

VCendol is an acronym of founder registered company which is Versatile Food and Beverage. V stands for Versatile and *cendol* is a local Malaysian favourite dessert. The main product for this business is *cendol* in the bottle. *Cendol* is an iced sweet dessert that contains droplets of green rice flour jelly, coconut milk and palm sugar syrup. It is commonly found in Southeast Asia including Malaysia especially in the East Coast Region.

Description of Retort Process for Ready-To-Drink (RTD)

VCendol transforms the *cendol* in a bowl (*mangkuk*) into a bottle due to increasing of consumer demand for high quality convenient ready-to-eat food products. This situation also leads to the rise of production of ready-to-eat products commercialisations (Kumar et al., 2013). Besides that, *VCendol* offers unique selling proposition in terms of Ready-To-Drink (RTD), premium *cendol* taste, convenient, long shelf-life and diversities of flavours such as *pandan*, strawberry and mango.

Background of Retort Process for Ready-To-Drink (RTD)

VCendol is totally different and offers new competitive advantages compared to existing *cendol*. Instead of mentioned unique selling proposition, *VCendol* highlights to cater short shelf-life issue as well as hygiene issue by using the retort process for ready-to-drink (RTD) *cendol*. Retort processing is a technology that has been widely acknowledged as one of the substitutions to metal cans for creating thermally handled shelf stable foods (Sabapathy et al., 2001; Abhishek, 2014). This process is withstanding thermal processing temperatures and combine the advantages of the metal can and plastic packages. This packaging is unique alternative packaging method for sterile, shelf stable products (Sabapathy & Bawa, 2003).

Advantages of Retort Process for Ready-To-Drink (RTD)

The retort process has many advantages over canned and frozen food packages, both for the customers as well as food manufacturers. The advantages of using this technology are consumers consistently can trust the safety of the product, have a longer shelf life and no preservatives will be needed as the product remains natural as possible. Additionally, this process is pouch profile, package cost, storage and preparation efficiency, savings in transportation, improved flavour and energy saving (Kumar et al., 2007; Mohammedali Shihab et al., 2013).

Commercial value Retort Process for Ready-To-Drink (RTD)

VCendol commercialization by improving the production from homemade into large scale production is expected to give impact on the community by offering job opportunities in terms of agents, stockists and runners. Small businesses contribute to local economies by bringing growth and innovation to the community in which the business is established. Through this, *VCendol* also helps stimulate economic growth and increase the GIG economy development in Malaysia which directly impacts the labour market. It contributes to local economies by bringing

growth and innovation to the community in which the business is established. Therefore, in this innovation an attempt has been made to develop shelf-stable RTD *cendol* as an alternate for soft drink products using retort process.

Acknowledgement

Special thanks to the Universiti Malaysia Kelantan (UMK), for giving us the gold opportunities to join Carnival of Research and Innovation (CRI) 2021. Our appreciation also goes to Faculty of Entrepreneurship and Business for endless support to participate in this valuable event. Special gratitude also goes to all "anonymous" juries, panels and judges for their so-called insights, although any errors are our own and should not tarnish the reputations of these esteemed persons.

References

- Kumar, R., Johnsy, G., Rajamanickam, R., Lakshmana, J.H., Kathiravan, T., Nataraju, S., & Nadasabapathi, S. (2013). Effect Of Gamma Irradiation And Retort Processing On Microbial, Chemical And Sensory Quality Of Ready-To-Eat (RTE) Chicken Pulav. *International Food Research Journal*, 20 (4), 1579-1584.
- Sabapathy, S. N., & Bawa, A. S. (2003). Retort Processing Of RTE Foods. *Food Nutrition World*, 1(12), 28–29.
- Sabapathy, S.N., Ramakrishna, A., & Srivastava, A. N. (2001). Current Status And Potential For Retort Processed Foods In India. *Indian Food Industry* 20(3), 78–79.
- Abhishek, V., Kumar, R., George, J., Nataraju, S., Lakshmana, J. H., Kathiravan, T., Madhukar, N., & Nadasabapathi, S. (2014). Development Of Retort Process For Ready-To-Eat (RTE) Soy-Peas Curry As A Meat Alternative In Multilayer Flexible Retort Pouches. *International Food Research Journal*, 21(4), 1553-1558.
- Mohammedali Shihab, C.P., Hafeeda, P., Kumar, R., Kathiravan, T., & Nadasabapathi, S. (2013). Development And Evaluation Of Shelf Stable Retort Processed Ready-To-Drink (RTD) Traditional Thari Kanchi Payasam In Flexible Retort Pouches. *International Food Research Journal* 20(4), 1765-1770.

BIOMARKERS EXPRESSION AS A SUCCESSFUL TREATMENT EFFICACY INDICATOR IN POST TREATMENT MANAGEMENT INNOVATION OF MANNHEMIOSIS IN GOATS

Mohd Farhan Hanif Reduan

Faculty of Veterinary Medicine, Universiti Malaysia Kelantan, Pengkalan Chepa 16100 Kota Bharu, Kelantan, Malaysia.
farhan.h@umk.edu.my

Jasni Sabri¹, Fathin Faahimaah Abdul Hamid¹, Nur Athirah Abd Manaf¹, Intan Noor Aina¹, Faez Firdaus Jese Abdullah²

¹Faculty of Veterinary Medicine, Universiti Malaysia Kelantan, Pengkalan Chepa 16100 Kota Bharu, Kelantan, Malaysia

²Faculty of Veterinary Medicine, Universiti Putra Malaysia, 43400, UPM Serdang, Selangor, Malaysia.
jasni@umk.edu.my, faahimaah@gmail.com, athirahmnf@gmail.com, intanaina@umk.edu.my, jesse@upm.edu.my

Highlights: Mannhemiosis is a disease that can cause sickness and death in sheep and goats. Therefore, treatment with the appropriate medication and monitoring the efficacy of the therapy are of deem importance. Knowing the efficacy can help in evaluating the chances of recovery (prognosis) of the sick animal so that a further treatment plan can be instituted. Our study had proven the synergistic effect of oxytetracycline (antibiotic) and flunixin (anti-inflammatory) to treat Mannhemiosis and the successful monitoring of the efficacy of these treatments, by the diminished expression of haptoglobin and an inflammatory cytokine (interleukin-6) levels in the blood. The potential of these agents as treatment efficacy bioindicator is revealed. This experimentation had led to the innovation of the treatment management including monitoring of its efficacy to save the life of affected animals and prevent economic losses.

Keywords: *Mannhemiosis, Acute phase protein, Inflammatory cytokines, Post treatment management innovation, Goats*

Introduction

Mannhemiosis caused by *Mannheimia haemolytica* is a serious endemic inflammatory disease in sheep and goats in Malaysia, causing economic losses through high morbidity and mortality (Zamri-Saad *et al.*, 1996). The pathogen led to fibrinous pneumonia with clinical signs of dyspnea in affected animals (Singh *et al.*, 2011). Haptoglobin is a major acute phase protein which is expressed at inflammatory sites (cellular changes) of different severity due to infection by pathogens (Cray, 2012). At the inflammation sites, cytokines such as interleukins are also released (Zhang & An, 2007).

The expression of these proteins and cytokines in the blood of goats with Mannhemiosis treated with combination of therapeutic agents has not been explored. Our study has shown that it can be the potential biomarker to imply whether a treatment regime is a success or failure and therefore, provide an early biomarker of the status of healing and as indicator, if the animal has a good chance of recovery or a slim chance of survival.

Content

Twenty male goats were divided into five groups (n=4). All groups except group 1 (negative control) were inoculated with *Mannheimia haemolytica* (10⁷cfu/ml) intranasally. Goats in group 2 were in positive control and did not receive any treatment. Goats in groups 3 and 4 were treated with an antimicrobial (Oxytetracycline, SID) at days 6 and 9 of post-infection and an anti-inflammatory drug (Flunixin meglumine, twice a day) at days 6,7,8,9,10 (5 days) post-infection, respectively. Meanwhile, goats in group 5 received both types of treatment for 5 days post treatment.

The study showed that immediately after infection (24 hours), the levels of haptoglobin were significantly (p<0.05) increased in the infected group compared to the negative control. On day 11 of post-infection and day 6 of post-treatment, the haptoglobin levels in groups 2, 3, 4 (single treatment) remained increased (p<0.05) in comparison to group 5 (both treatment) and negative control. In contrast, inflammatory cytokine levels within 24 hours and day 5 of inoculations significantly increased in the inoculated groups (2,3,4,5) compared to the negative control. Interestingly, on days 9 and 11, the level of interleukin-6 in groups 4 and 5 was significantly lower (p<0.05) than in other groups.

The group 5 animals completely recovered from the clinical signs which include pyrexia, coughing, mucopurulent nasal discharges. Only very mild nasal discharges were seen.

Innovation of the Study

Therefore, the innovation derived from this study can be practiced is as written below:

1. Symptomatic treatment of animals with initiation of respiratory clinical signs with Oxytetracycline, once a day, for two consecutive days, intramuscular, at the concentration of 20mg/kg and Flunixin meglumine, twice a day, for 5 consecutive days, at 1.1 mg/kg concentration.

2. Taking serum blood samples from the initiation of respiratory clinical signs and at days 3, 6 and 9 (3 alternate days) for haptoglobin and interleukin-6 expression levels analyses to monitor the treatment efficacy, severity of the disease and prognosis.
3. The levels can be detected by using an Enzyme Linked Immunosorbent assay (ELISA) kit that can be purchased in the market.

Significance of the Study

This innovation can impart health, prognosis, antibiotic resistance alert and economic significance. This study has proven that the combination of both oxytetracycline and flunixin meglumine can lead to healing progression in goats with Mannheimiosis.

The efficacy of such treatment can be assessed and monitored by the decreased levels of haptoglobin and interleukin-6 expressions in the blood and therefore, imply that these acute phase protein and inflammatory cytokines are potentially good biomarkers of healing responses worthy of application in post treatment managements by practicing Veterinarians in the future.

Such success stories, would lead to prosperity of livestock production by the prevention of economic losses. The economic losses from sickness and death of affected animals can be prevented when the chances of recovery (prognosis) are known and modification of treatment regimes can be made from the results of the expression of these biomarkers. Furthermore, the bioindicator expressions can also be an indicator of the severity of infection and the possibility of antibiotic resistance. This treatment management innovation is much recommended.

Acknowledgement

We are grateful to the Ministry of Higher Education for the R/FRGS/A0600/01391A/001/2019/00668 grant to complete the research works.

References

- Cray, C. (2012). Acute phase proteins in animals. In *Progress in Molecular Biology and Translational Science* (Vol. 105, Issue January). <https://doi.org/10.1016/B978-0-12-394596-9.00005-6>
- Singh, K., Ritchey, J. W., & Confer, A. W. (2011). *Mannheimia haemolytica*: Bacterial – Host Interactions in Bovine Pneumonia. 48(2), 338–348. <https://doi.org/10.1177/0300985810377182>
- Zhang, J.-M., & An, J. (2007). Cytokines, inflammation, and pain. *International Anesthesiology Clinics*, 45(2), 27–37. <https://doi.org/10.1097/AIA.0b013e318034194e>
- Zamri-Saad, M., Effendy, A. W. M., Maswati, M. A., Salim, N., & Sheikh-Omar, A. R. (1996). The goat as a model for studies of pneumonic pasteurellosis caused by *Pasteurella multocida*. *British Veterinary Journal*, 152(4), 453-458.

KOMBU-FEED⁺: INCORPORATION OF BLACK SOLDIER FLY LARVAE MEAL AND KOMBUCHA TEA AS FISH FEED REPLACEMENT AND FEED SUPPLEMENT TO AFRICAN CATFISH, *CLARIAS GARIEPINUS*.

Ruhil Hayati Hamdan

Faculty of Veterinary Medicine, UMK, Pengkalan Chepa, 16100 Kota Bharu, Kelantan, Malaysia
ruhil@umk.edu.my

Tan Li Peng¹, Mohd Farhan Hanif Reduan¹, Nora Faten Afifah Mohamed¹, Ain Auzureen Mat Zin¹, Chan Jian Ern¹, Ahmad Syazwan Samsuddin²

¹Faculty of Veterinary Medicine, UMK, Pengkalan Chepa, 16100 Kota Bharu, Kelantan, Malaysia

²Mycology and Pathology Laboratory, Forest Research Institute Malaysia

, li.peng@umk.edu.my, farhan.h@umk.edu.my, faten.m@umk.edu.my, ainauzureen@gmail.com, jianern.d16a0006@siswa.umk.edu.my, ahmadsyazwan@frim.gov.my

Highlights: Black soldier fly larvae (BSFL) is one of the most used insects as a cheaper alternative protein source in fish feed, while, Kombucha is a fermented sugared tea that is beneficial for supplementation. This innovative fish feed is a substitution of 15% BSFL as protein source and combination of Kombucha tea. As a result, specific growth rate was achieved of almost two-fold compared to the control group. Therefore, aquaculturists and feed producer can explore the potential of this cheaper alternative of protein source and Kombucha as feed supplement.

Key words: insect protein source, fermented tea, growth performance, fish feed

Introduction

Choice of feed ingredients directly influence the growth rate, quality and overall production cost of an animal (Belghit et al., 2019). Therefore, it is essential to understand the perks of different types of feed, in order to facilitate the development of the aquaculture industry sector as a whole. Feed costs usually represent 60-70% of total production costs (Spranghers et al., 2017), thus it is important to constantly review the efficiency of the ration being used for the livestock. By using cheaper but viable alternative protein sources, the overall profit of the industry can be improved. For this reason, insect is an excellent choice of alternative, as it can also be reared on low value organic waste streams, yet achieving a good feed conversion efficiency, and can substitute the traditional protein source for livestock feed without apparent adverse effect (Spranghers et al., 2017). Kombucha or tea fungus, a product formed by fermentation of sugared tea with a symbiotic culture of acetic acid bacteria and yeasts, is proven to improve the growth rate of African catfish, helping in nutritional utilization, by regulating and improving gastrointestinal function (Muthusamy et al., 2020). It can also improve the general health of catfish by its anti-inflammatory, immunity enhancement and antioxidant properties (Muthusamy et al., 2020).

Content

Description of innovation product development

Substitution of 15% BSFL as protein source in fish feed and combination of Kombucha tea as feed supplement.



Background of the product development

One of aquaculture's drawbacks is heavy reliance on non-sustainable protein sources for aqua feed. The search for alternative and sustainable protein sources has rendered insects as an attractive option in fish diets, since fish naturally consume insects. Insects have a satisfactory amino acid profile and are rich in fats, minerals and vitamins.

Important to aquaculture industry.

As the cost of conventional protein sources such as fishmeal and soybean meal continues to increase, it will only be a matter of time before the economic advantages of producing BSF larvae meals as a cheap source of protein becomes apparent to many aquaculturists and feed manufacturers.

Advantages of product development

With the introduction of BSF larvae meal and *Kombucha* supplementation in catfish diet, it can potentially be a cheaper feed formulation that can also improve the growth performance and general health of African catfish, *Clarias gariepinus*.

Commercial value in terms of marketability or profitability of product development

Cheaper price of KOMBU-FEED⁺ compared to commercial diet and the fast growth performance African Catfish, *Clarias gariepinus*.

References

- Belghit, I., Liland, N.S., Gjesdal, P., Biancarosa, I., Menchetti, E., Li, Y., Waagbø, R., Krogdahl, Å., & Lock, E.J. (2019). Black soldier fly larvae meal can replace fish meal in diets of sea-water phase Atlantic salmon (*Salmo salar*). *Aquaculture*, 503, 609-619.
- Muthusamy, J., Hamdan, R.H., & Peng, T.L. (2020). Kombucha Tea as Feed Supplement for African Catfish, *Clarias gariepinus*. *Asian Journal of Applied Sciences*, 13: 114-117.
- Spranghers, T., Ottoboni, M., Klootwijk, C., Obyn, A., Deboosere, S., De Meulenaer, B., Michiels, J., Eeckhout, M., De Clercq, P., & De Smet, S. (2017). Nutritional composition of black soldier fly (*Hermetia illucens*) prepupae reared on different organic waste substrates. *Journal of the Science of Food and Agriculture*, 97(8), 2594-2600.

PHOSPHATE SOLUBILIZING BACTERIA FROM PADDY RHIZOSPHERE AS BIOFERTILIZER

Nik Fatin Qharanie Binti Nik Mohd Kamaruzaman

Universiti Malaysia Kelantan, Jeli, Malaysia
fatinqharanie@yahoo.com

Ainihayati Binti Abdul Rahim

Universiti Malaysia Kelantan, Jeli, Malaysia
ainihayati@umk.edu.my

Highlights: Phosphate solubilizing bacteria (PSB) is the bacteria that able to enhance the plant growth as well as increase crop yield by solubilizing insoluble phosphate from the soil into the form that can be uptake by plants. Result from this project suggests that PSBs isolated from paddy rhizosphere could be exploit as biofertilizer, thus, having a big potential as an alternative to replace chemical fertilizer.

Key words: Phosphate Solubilizing Bacteria, rhizosphere, insoluble phosphate, biofertilizer, chemical fertilizer

Introduction

Chemical fertilizer has been widely used in agriculture to increase crop yield. However, excess usage of chemical fertilizer may cause harmful effects such as air pollution, water pollution, increase soil acidity, and also might contributes to the greenhouse gas emission (Chen et al., 2018; Wang et al., 2018). Therefore, a new alternative is needed to replace the chemical fertilizer. Previous researcher has established that microbes can be exploited as biofertilizers (Olanrewaju et al., 2017). The microbes that act as biofertilizer react differently than chemical fertilizer as this kind of fertilizer supply nutrients directly to the plants, but biofertilizer helps plant indirectly by helping the plant's nutrient uptake process.

Phosphorus is one of the essential macronutrients for plant development and growth in metabolic activities such as energy transmission, carbon metabolism, membrane formation, signal transduction, respiration, macromolecular biosynthesis, and photosynthesis (Wu et al., 2005; Anand et al., 2016; Yadav et al., 2017; Gouda et al., 2018). However, the presence of phosphorus has become a limiting factor where it is cannot be directly absorb by plant as 95 to 99 percent of phosphorus is insoluble, immobilized, or precipitated form while plants can only absorb phosphate as dihydrogen phosphate ($H_2PO_4^-$) ions and hydrogen phosphate (HPO_4^{2-}) ions (Awais et al., 2017; Gouda et al., 2018). Solubilization of phosphate can be done by PSB by releasing of organic acids, phosphatase and phytase enzymes (Khan et al., 2016). Hence, this project was conducted to isolate PSBs from paddy (*oryza sativa*) rhizosphere on selective media namely Pikovskaya medium and measuring their ability in solubilizing phosphate qualitatively using phosphate solubilization index (PSI) test.

Content

This project starting with the isolation of the product which is PSB from paddy rhizosphere on selective media, Pikovskaya medium containing insoluble phosphate which is tricalcium phosphate. Total of 59 colonies of PSB were successfully isolated and nine colonies were selected based on the diameter of halozone formed on Pikovskaya medium and namely as P-PS1, P-PS2, P-PS3, P-PS4, P-PS5, P-PS6, P-PS7, P-PS8, and P-PS9.

The ability of the isolates in solubilizing phosphate were evaluated by measuring the phosphate solubilizing activity qualitatively using phosphate solubilization index (PSI) test. Result shows the nine PSBs isolated from paddy rhizosphere have an ability to solubilize phosphate with different efficiency by showing different diameter of halozone which the solubilization index (SI) varies from 1.35 to 6.75 on day 7 as shown in Table1. The highest phosphate solubilization activity was shown by P-PS3 with SI 6.75. According to Sudewi et al., 2020, the halozone obtained as a result of the solubilization process of the tricalcium phosphate in pikovskaya medium into a soluble form by PSB. Result suggests that PSBs isolated especially P-PS3 could be exploit as biofertilizer as they able in solubilizing insoluble phosphate, thus, having potential in replacing chemical fertilizer. The usage of PSB as biofertilizer not only could reduce the negative effect cause by the application of chemical fertilizer as PSB is environmental friendly, but it is also cheaper than chemical fertilizer which could help the farmers reduce the cost of fertilizer usage. Nevertheless, a further research needs to conduct to explore the phosphate solubilizing activity by quantitative technique such as Vanadate Molybdate Assay, and Phytase Assay, and also validate the plant growth promoting activity using in vitro analysis by performing Seed Vigour Index (VSI) test.

Table 1: Phosphate Solubilization Index (PSI) test on PSBs

Isolates	Solubilization index (SI)		
	Days of incubation		
	Day 3	Day 5	Day 7
¹ -PS1	1.42	1.48	1.40
² -PS2	1.56	1.58	1.66
³ -PS3	4.17	5.78	6.75
⁴ -PS4	1.42	1.54	1.46
⁵ -PS5	1.40	1.33	1.41
⁶ -PS6	1.47	1.56	1.72
⁷ -PS7	1.31	1.44	1.40
⁸ -PS8	1.51	1.45	1.40
⁹ -PS9	1.30	1.38	1.35

Acknowledgement

This work is supported by the Fundamental Research Grant Scheme (FRGS) R/FRGS/A1300/01106A/005/2019/00703 awarded by the Ministry of Higher Education (MOHE). Authors would like to thank the Faculty of Bioengineering and Technology and Universiti Malaysia Kelantan for their support in this research work.

References

- Anand, K. U. M. A. R., Kumari, B., & Mallick, M. A. (2016). Phosphate solubilizing microbes: an effective and alternative approach as biofertilizers. *J Pharm Pharm Sci*, 8, 37-40.
- Awais, M., Tariq, M., Ali, A., Ali, Q., Khan, A., Tabassum, B., ... & Husnain, T. (2017). Isolation, characterization and inter-relationship of phosphate solubilizing bacteria from the rhizosphere of sugarcane and rice. *Biocatalysis and Agricultural Biotechnology*, 11, 312-321.
- Chen, J., Lü, S., Zhang, Z., Zhao, X., Li, X., Ning, P., & Liu, M. (2018). Environmentally friendly fertilizers: A review of materials used and their effects on the environment. *Science of the total environment*, 613, 829-839.
- Gouda, S., Kerry, R. G., Das, G., Paramithiotis, S., Shin, H. S., & Patra, J. K. (2018). Revitalization of plant growth promoting rhizobacteria for sustainable development in agriculture. *Microbiological research*, 206, 131-140.
- Khan, A. A., Jilani, G., Akhtar, M. S., Naqvi, S. M. S., & Rasheed, M. (2009). Phosphorus solubilizing bacteria: occurrence, mechanisms and their role in crop production. *J. agric. biol. sci*, 1(1), 48-58.
- Olanrewaju, O. S., Glick, B. R., & Babalola, O. O. (2017). Mechanisms of action of plant growth promoting bacteria. *World Journal of Microbiology and Biotechnology*, 33(11), 197.
- Sudewi, S., Ala, A., Patandjengi, B., & BDR, M. F. (2020, October). Isolation of phosphate solubilizing bacteria from the rhizosphere of local aromatic rice in Bada Valley Central Sulawesi, Indonesia. In *IOP Conference Series: Earth and Environmental Science* (Vol. 575, No. 1, p. 012017). IOP Publishing.
- Wang, Y., Zhu, Y., Zhang, S., & Wang, Y. (2018). What could promote farmers to replace chemical fertilizers with organic fertilizers?. *Journal of cleaner production*, 199, 882-890.
- Wu, H., Ito, K., & Shimoi, H. (2005). Identification and characterization of a novel biotin biosynthesis gene in *Saccharomyces cerevisiae*. *Applied and environmental microbiology*, 71(11), 6845-6855.
- Yadav, A. N., Verma, P., Singh, B., Chauhan, V. S., Suman, A., & Saxena, A. K. (2017). Plant growth promoting bacteria: biodiversity and multifunctional attributes for sustainable agriculture. *Adv Biotechnol Microbiol*, 5(5), 1-16.

SPINACH CRACKER: A NEW SNACK FOOD FOR EVERYONE

Leony Tham

Faculty of Agrobased Industry, Universiti Malaysia Kelantan, 17600 Jeli, Kelantan.
leonytham@umk.edu.my

Daphane Teo Wen Xin, Nurhanan, A.R

Faculty of Agrobased Industry, Universiti Malaysia Kelantan, 17600 Jeli, Kelantan.
daphanetwx@gmail.com, nurhanan.ar@umk.edu.my

Highlights: Incorporating spinach vegetables in baked food has improved the nutritional values, physical properties and creating new flavor of the cracker. This study was conducted to develop a new food product from locally grown vegetables known as spinach. The new crackers developed indicated the increase in ash, fat and protein content while decrease in moisture content. The new spinach crackers developed contained dietary fibre and other important nutrients essential for health and also received high acceptability among sensory panels. Thus, this new snack food is highly recommended to be commercialized to provide better choice for consumers.

Key words: *green spinach, red spinach, cracker, snack food*

Introduction

Spinach is a leafy green vegetable belongs to the Amaranthaceae family. In Malaysia, there are two species of spinach commonly consumed that are green spinach (*Spinacia oleracea*) and red spinach (*Amaranthus dubius*). Spinach's leaves contain vitamin A, vitamin B6, vitamin C, chlorophyll, beta carotene, and riboflavin as well as multiple secondary metabolites such as alkaloid, flavonoid, tannin, glycoside and many more (Muliani et al., 2017). Both green and red spinach are rich in vitamin C. Spinach is known to be abundant in antioxidant, dietary fibre, minerals, vitamins, and iron compound which is beneficial to prevent anaemia (Miano, 2016). According to American Society of Hematology, iron plays a vital role in maintaining body functions which include production of haemoglobin, molecule in blood that carries oxygen throughout the body. Iron is also necessary to maintain healthy cells, skin, hair and nails. Iron deficiency anaemia develops when iron in the body drop too low to support normal red blood cell production (Harper, 2018).

Spinach is easily grown in Malaysia and that is the reason why this vegetables could be found abundantly in local markets. The main problem in purchasing fresh vegetables is their short life cycle. Maximum shelf life for spinach reported was 3 days at ambient condition (Kakade et al., 2015). A short shelf life of spinach will also cause economic loss as they have to discard the deteriorated vegetables.

The awareness regarding importance of consuming nutritious foods like vegetables in preventing diseases and improving quality of life have been increasing among consumers nowadays. The demand for food that is rich in dietary fibre has increased in the past decade and lead to the development of many fibre rich products and ingredients (Drzikova et al., 2005). Specific properties of dietary fibre has been reported to play an important role in preventing and treating various gastrointestinal disorders such as constipation, obesity, coronary heart disease, colorectal cancer and diabetes (Bingham, Day, Luben & Ferrari, 2003). According to Han et al. (2017), dietary fibres are often characterized by high nutritional quality because they are able to cure many chronic diseases and improve texture, sensory characteristics, and shelf life of foods.

Many consumers are very concerned about food they eat and prefer to choose those without additives. Crackers is example of snack food favourable by all ages and very convenient food product. Cracker have several characteristics in terms of crispiness, less sweet and savoury flavours (Davidson, 2016). Hence, the development of vegetable based products will save many fresh vegetables and decrease the amount of discarded commodity.

Spinach was found neglected due to limited usage in development of products especially in bakery products and is usually being consumed in fresh. Some people tend to avoid eating fruit and vegetable in fresh thus, causes them to have vitamin or mineral deficiency. Multiple micronutrient deficiency is more common than single deficiency in developing countries due to poor food consumption and bioavailability of micronutrients (Gupta & Prakash, 2011). In addition, most of the products that being marketed contains high amount of sugar with additional chemical preservatives, flavour enhancer, colouring agent and other additives which are main concern for some consumers.

In this project, a new snack food product has been developed from both green and red spinach vegetables. The spinach crackers were analyzed for proximate composition, texture property, colour analysis and sensory evaluation. The shelf life of the cracker was determined by emphasizing on its physical properties up to three weeks of storage. The spinach cracker is incorporated at between 5% to 15% level of incorporation exhibit natural green colour of the cracker. The presence of pigment such as chlorophylls, carotenoids and betacyanins in spinach powder enable it to act as a natural food colourant in baked foods. Increasing level of spinach powder in crackers has decreases the moisture content but increases nutritional values such as ash, fat and protein content (Figure 1). Moreover, crackers incorporated with either red or green spinach received higher sensory acceptability than control cracker (Figure 2).

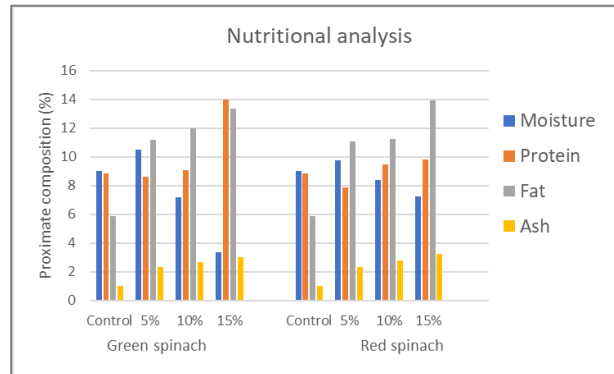

Figure 1: Nutritional composition of crackers incorporated with green and red spinach

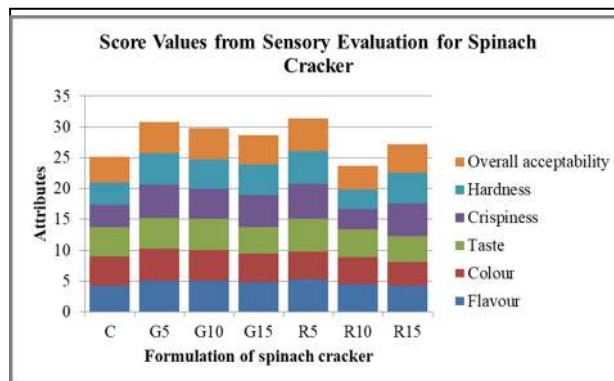

Figure 2: Sensory evaluation of control and spinach crackers formulated with 0%-15% of spinach.

Snack foods like spinach crackers are necessary because they bridge the gaps between main meals besides providing a little mental reset, and oftentimes lead to a healthier weight as well. Incorporating snack foods into mid-morning and mid-afternoon can help to balance out blood sugar. A proper snack can also lead to sustained energy by providing you with energy all day long. We recommend that spinach crackers can be commercialized as healthy snack food in the future. To the best of our knowledge, spinach crackers have not been available in our markets yet. Besides the commercial values of healthy snack food, development of vegetable based products help socioeconomic growth among communities. Spinach can be cultivated using both traditional and smart farming technology to produce larger amount of vegetables. The participation of urban and rural communities in vegetable farming will definitely help to improve their economic status.

Acknowledgement

We thanked Faculty of Agrobased Industry (FIAT) for all the supports.

References

- Bingham, S. A., Day, N. E., Luben, R. & Ferrari, P. (2003). Dietary fibre in food and protection against colorectal cancer in the European prospective investigation into cancer and nutrition (EPIC): An observational study. 361(9368), 1496-1501.
- Davidson, I. (2016). Biscuit baking technology. 2nd Edition.
- Drzikova, B., Dongowski, G., Gebhardt, E. & Habel, A. (2005). The composition of dietary fibre-rich extrudates from oat affects bile acid binding and fermentation in vitro. Food Chemistry, 90(1-2), 181-192.
- Gupta, S. & Prakash, J. (2011). Nutritional and sensory quality of micronutrient-rich traditional products incorporated with green leafy vegetables. International Food Resource Journal, 18, 667-675.
- Han, W., Ma, S., Li, L., Wang, X. & Zheng, X. (2017). Application and development prospects of dietary fibers in flour products. Journal of Chemistry, 8.
- Harper, J. L. (2018). Iron deficiency anemia. Medscape. Retrieved November 22, 2019 from <https://emedicine.medscape.com/article/202333-overview>.
- Kakade, A., More, P., Jadhav, S. and Bhosle, V. (2015). Shelf life extension of fresh-cut spinach. International Journal of Agriculture, Environment and Biotechnology, 8(3), 609-614.
- Miano, T. F. (2016). Nutritional value of Spinacia oleracea spinach-an overview. International Journal of Life Sciences and Review, 2(12), 172-174.
- Muliani, R. H., Soejono, A., Suherni, T., Hadisaputro, S. & Mashoedi, I. D. (2017). Effect of consuming red spinach (Amaranthus Tricolor L) extract on haemoglobin level in postpartum mothers. Belitung Nursing Journal, 3(4), 432-437.

ProovyFeed: POULTRY FEED OF SUSTAINABLE PROTEIN SOURCES

Khairiyah Mat

Faculty of Agro-Based Industry, Universiti Malaysia Kelantan, 17600 Jeli, Kelantan, Malaysia
Institute of Food Security and Sustainable Agriculture, Universiti Malaysia Kelantan, 17600 Jeli, Kelantan, Malaysia
khairiyah@umk.edu.my

Nor Dini Rusli^{1,2}, Hasnita binti Che Harun^{1,2}, Zulhisyam bin Abdul Kari¹, Mohammad Mijanur Rahman¹, Mohd bin Mahmud¹, Syed Muhammad Al-Amsyar¹, Lee Seong Wei¹ and Leony Tham Yew Seng¹

¹Faculty of Agro-Based Industry, Universiti Malaysia Kelantan, 17600 Jeli, Kelantan, Malaysia
²Institute of Food Security and Sustainable Agriculture, Universiti Malaysia Kelantan, 17600 Jeli, Kelantan, Malaysia
nordini@umk.edu.my, hasnita@umk.edu.my, zulhisyam.a@umk.edu.my, mijanur.r@umk.edu.my, mohd@umk.edu.my, amsyar@umk.edu.my, leeseong@umk.edu.my, leonytham@umk.edu.my

Highlights: *ProovyFeed*: Poultry Feed of sustainable protein sources. The innovation is created by transforming waste and renewable sources of protein into high-value outputs at a cheaper cost, ensuring that white meat production is affordable and our nation's food security is secured. This innovation is made entirely of wholesome feed ingredients that are locally available. A very well poultry feed formulation incorporates BSFL and food-industrial by-products, which is known as *budu*. The prototype is now at TRL Level 6. Additionally, *ProovyFeed* has a promising commercialization potential due to its comparable quality to commercial feed, relatively low cost of materials, and the use of industrial by-products as a renewable protein source.

Key words: *alternative protein source, low-cost poultry feed, local ingredients*

Introduction

Farmers have recently been burdened with the cost of feed in order to meet the nutrition requirements of poultry in optimal condition. The cost of feed raw materials, on the other hand, is rising, particularly for protein sources such as fish meal, bone meal, and soybean meal. On the other hand, Anchovies waste from the *budu* industry in Kelantan is not being fully utilised and is being discarded. It has been shown to have a positive effect on the growth rate of tilapia (Putra et al. 2018). The larvae of the black soldier fly (BSFL) can be an excellent nutritional source for layer hens, broiler chickens (Cockroft 2018), and fish (Xiao et al. 2018). It contains a high concentration of essential amino acids, which aid in animal growth (Shumo et al. 2019). Protein sources in the feed are crucial in the development of animal tissues.

As a result, adequate protein sources are required for animal growth and tissue development, which will have an impact on growth efficiency and development. The majority of protein supplies used to manufacture feed in Malaysia are imported from other countries, which is costly and has an impact on production costs. As a result, it is critical to identify local raw materials that can be used to replace or supplement manufactured protein supplies. However, anchovy waste and Black Soldier Fly Larvae (BSFL) have the potential to be used as protein substitutes in poultry feed. Anchovy waste and BSFL are both less expensive and easier to obtain than fishmeal and soybean meal. This innovation aims to improve poultry production by delivering high-quality feed at a low cost by utilising waste and renewable protein sources.

Content

Aside from the new formulation of poultry feed using local feed ingredients with BSFL as the primary protein source, *ProovyFeed* follows the Halalan Toyyiban concept. *ProovyFeed* has a promising commercialization potential due to its comparable quality to commercial feed, lower cost of ingredients, and use of industrial by-product as a protein source. *ProovyFeed* can be classified as a product with a long-term impact in terms of innovation impact. It is necessary to develop the finest poultry feed formulation using local feed ingredients.

Furthermore, the effective inclusion rate of black soldier fly larvae (BSFL) meal and anchovy by-products as protein source must be accurately identified through a series of feeding trial and lab analysis. This innovation is very important to minimize the gap of knowledge related to poultry nutrition and feed quality of local ingredients. The use of BSFL aids in lowering the cost of imported materials. Reusing food-industrial byproducts as ingredients can help to reduce pollution in the environment. Poultry production as a driver of food security and long-term development. This innovation also supporting SDG-12; responsible consumption and production. Because of its comparable quality to commercial feed, low material costs, and use of industrial by-products as a renewable protein source, this innovation has a promising commercialization potential.

Acknowledgement

This project was supported by the Rising Star Grant Scheme of Universiti Malaysia Kelantan.

References

- Cockcroft, B.L., 2018. An evaluation of defatted black soldier fly (*Hermetia illucens*) larvae as a protein source for broiler chicken diets. Master's Thesis, Stellenbosch University, Stellenbosch, South Africa.
- Putra, A., Dahlan, I., & Pratama, A. (2018). InJAR Substitution of Anchovy Waste Flour for Fish Meal as. 01 (02), 105–111.
- Shumo, M., Osuga, I.M., Khamis, F.M., Tanga, C.M., Fiaboe, K.K.M., Subramanian, S., Ekese, S., van Huis, A., Borgemeister, C., 2019. The nutritive value of black soldier fly larvae reared on common organic waste streams in Kenya. *Scientific Reports*, 9: article number 10110. Retrieved from <https://doi.org/10.1038/s41598-019-46603-z>
- Xiao, X., Jin, P., Zheng, L., Cai, M., Ziniu, Y., Yu, J., Zhang, J., 2018. Effects of black soldier fly (*Hermetia illucens*) larvae meal protein as a fishmeal replacement on the growth and immune index of yellow catfish (*Pelteobagrus fulvidraco*). *Aquaculture Research*. 10.1111/are.13611.

ACTIVATED CARBON FROM FOXTAIL PALM FRUIT FOR REMOVAL OF METHYLENE BLUE, Cr(IV) AND METAMIFOP

Nik Raihan Nik Yusoff

Faculty of Earth Science, Universiti Malaysia Kelantan, Jeli Campus, Jeli, Kelantan, Malaysia
nrailhan@umk.edu.my

Nisrina Nadia, Noor Syuhadah Subki, Rozidaini Mohd Ghazi, Asanah Radhi, Nik Nurul Anis, Musfiroh Jani^{ff}, Noor Janatun Naim, Marinah Muhammad

Faculty of Bioengineering and Technology, Universiti Malaysia Kelantan, Jeli Campus, Jeli, Kelantan, Malaysia
nisrinanadia85@yahoo.com., syuhadah@umk.edu.my, rozidaini@umk.edu.my, asanah@umk.edu.my, anis.ny@umk.edu.my, musfiroh@umk.edu.my, janatunnaim@umk.edu.my, marinah@umk.edu.my

Highlights: The activated carbon was prepared using foxtail palm fruit which activated by nitric acid (HNO₃) carbonized at 500°C for 2.5 hours in a furnace. The produced activated carbon was then treated for various types of pollutants. In this study, the pollutants were methylene blue, chromium and metamifop. The activated carbon were able to give high percentage removal due to well-developed pores resulted from evaporation of chemical reagent which was nitric acid during carbonization that leaving empty space on the surface.

Key words: adsorption, activated carbon, foxtail palm fruit, methylene blue, Cr, metamifop

Introduction

Many activated carbon derived from agro-waste have been proposed since the use of commercially available activated carbon is costly. Therefore, the production of activated carbon from agro-waste would be a better option as it is less expensive and environmental friendly. Activated carbon can be produced from any type of carbonaceous materials or agro-waste such as coconut shell, orange peels, rice husk and many more. It has been reported that all activated carbons prepared from agro-waste capable in removing heavy metals, reducing dye pollutant from aqueous solutions and many more. A good activated carbon will be produced from agricultural waste which contained high carbon content, stability of supply in the countries, higher potential extend of activation and inexpensive materials such as the foxtail palm fruit. Due to this, activated carbon prepared from agro-waste is conducted. The agro-waste that will be used is *Wodyetia bifurcata* or known as Foxtail palm. It is a species of palm in the Arecaceae family where popularly planted in Malaysia and around the world as a landscape plant. Foxtail palm tree produce flowers and bunches of fruits that contain seeds. The foxtail fruits do not have any specific usage and always being left until rot.

Content

Preparation of Activated Carbon: Foxtail palm fruits were collected around Jeli, Kelantan, Malaysia. The foxtail palm tree and the fruits were shown in Fig. 1. The fruits were washed several time with distilled water as to remove surface impurities and then dried in an oven at 100 °C overnight. The dried fruits were hard to crush, hence, need to be carbonized at 300 °C. The carbonization was conducted for two hours in order to get the char samples and allowed to cool in that furnace for three hours. Next, the char samples were crushed using miller blender, sieved to pass through 250 μm and kept stored in desiccator for further chemical activation process. The prepared char was weighed about 40 g and added to the conical flask containing 80 ml of concentrated HNO₃. The mixture was mixed vigorously for 30 minutes until became paste with constant stirring for homogeneity and left overnight for impregnation. After that, the sample was carbonized for 2.5 hours in furnace with temperature of 500 °C. Finally, the produced activated carbons were rinsed with distilled water until the distillate was pH7. The carbon samples were dried at 150 °C for 3 hours in the oven and kept in air thigh container prior using for dye removal process.

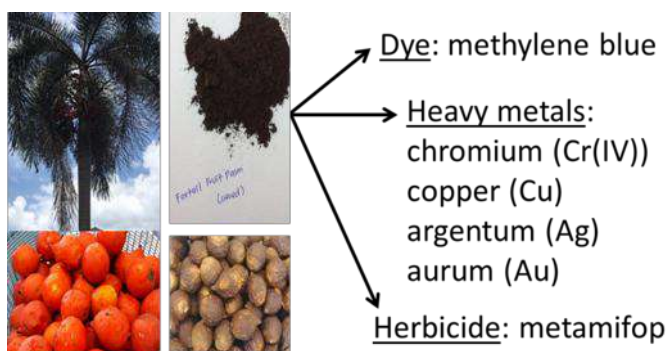

Figure 1: The activated carbon from foxtail palm fruit that applied in adsorbing various types of pollutants such as herbiced, dye and heavy metals

Commonly, many researches used activated carbon from various type of agro-waste in order to find out their performance in treating one type of pollutant. However, for this innovation, the produced activated carbon from one source of agro-waste which is foxtail palm fruit has been applied to remove various types of pollutants. The performance of 5 g activated carbon in removing methylene blue (Nik Yusoff et al., 2020), Cr(IV) (Azami, 2019) and metamifop (Layli, 2019) through adsorption process was shown in Table 1.

Table 1: Removal value for each type of pollutants using 5 g of activated carbon derived from foxtail palm fruit.

Type of pollutant	Name of pollutant	Adsorption conditions	Removal value
Dye	Methylene blue	5 g of activated carbon, 2 mg/L of methylene blue, 150 minutes of contact time	97.10%
Heavy metal from textile effluent	Chromium, Cr	5 g of activated carbon, textile effluent at pH 10.7 with 120 minutes of contact time	50.00%
Heavy metal from printed circuit board (PCBs) leachate	Argentum, Ag	5 g of activated carbon, 40 minutes of contact time	29.95%
	Aurum, Au		60.87%
	Copper, Cu		35.11%
pesticide	Metamifop	5 g of activated carbon, 10 mg/L of metamifop at 30 minutes of contact time	83.48%

It has been demonstrated that the developed activated carbon can be used to remove a variety of pollutants. In addition, as demonstrated in Table 1, this product is capable of adsorbing heavy metals such as Ag, Au and Cu from printed circuit board leachate.

Acknowledgement

The authors thank Faculty of Earth Science and Faculty of Engineering and Technology, University Malaysia Kelantan for providing all facilities and excellent technical assistance for the completion of this research.

References

- Azami, H. A. M. (2019). Removal of Cr(IV) contain in dye textile industry effluent by using foxtail palm fruit as activated carbon (Bachelor dissertation, Universiti Malaysia Kelantan).
- Layli, N. N. M. (2019). Removal of metamifop using foxtail palm fruit as potential activated carbon (Bachelor dissertation, Universiti Malaysia Kelantan).
- Nik Yusoff, N. R., Jefry, S. J. M., Lai, Y. T., Abdul Halim, N. S. and Subki, N. S. (2020). Methylene blue removal using foxtail palm fruits as potential activated carbon, *Material Science Forum* 1010, 477-482.

BIOCIDE FOR SICK BUILDING SYNDROME FUNGUS (BioC-F)

Muhamad Azahar Abas

Faculty of Earth Science, Universiti Malaysia Kelantan, Jeli, Malaysia
azahar.a@umk.edu.my

Kamarul Ariffin Hambali, Muhammad Firdaus Abdul Karim, Lukman Ismail, Nor Hizami Hassin, Nurul Syazana Abdul Halim, Amal Najihah Muhamad Nor, Hamzah Hussin, Hafizi Rosli

Faculty of Earth Science, Universiti Malaysia Kelantan, Jeli, Malaysia
Universiti Sains Malaysia, Penang, Malaysia

Highlights: Indoor air quality plays an important role in human health. One of the negative impacts of poor indoor air quality is sick building syndrome (SBS). The main factor that contributes to SBS is biological pollutants such as fungi, bacteria and viruses. Previous studies show that 90% of building in Malaysia has risk to be exposed towards sick building syndrome because of the weather. Accordingly, the antifungals spray product was innovated by using *Strobilanthes crispus* extract as a natural biocide against SBS fungi that can be beneficial for society because it is harmless and non-toxic to human. The novelty of this product is the plant-based antifungal that nontoxic to human and low production cost. The study shows that the antifungal spray demonstrates the features like easy to use, practical, and less than 2 days guarantee effective in inhibiting fungal mycelium by 100%. The product has commercial value in term of antifungal spray for household usage and as an additive for commercial paint. The study if this product has supported by research university grant number 1001/PBIOLOGI/811147, three (3) high impact publication and international industry support.

Key words: Sick building syndrome, Natural biocide, Indoor air quality

Introduction

Various types of bacteria and fungi grow on the walls of buildings¹, causing erosion and degradation of the building. Failure in controlling the growth of microorganisms inside the building will cause deterioration of indoor air quality, hence leading to sick building syndrome (SBS). According to Ajam et al. (2012), SBS is a major concern in Malaysia. In the United States, the World Health Organization (WHO) discovered that almost 30% of their residents have experienced SBS. According to Syazwan et al (2009), the building occupants are usually unaware that they been exposed to this syndrome until they experience health issues, like breathing problems. Thus, an indoor air quality assessment is crucial to identify buildings that have SBS. Poor ventilation in the building may leads to the accumulation of spores, bacteria and virus on the surfaces of carpets, curtains, tablecloths or furniture, further polluting the indoor air environment of a building.

Several studies have been conducted to mitigate the presence of microorganisms in the indoor air. One of the popular approaches is by using plant extracts containing antifungal properties. Various types of medical plants contain antifungal compounds such as alkaloid. The selection of the plant species for an antifungal activity test should be based on the content of the secondary metabolite, as the secondary metabolites are species. Secondary metabolites play a role in supporting the plant defence mechanism against fungi and bacteria infections. For example, sesquiterpenoid alkaloid that works effectively inhibiting the reproduction of microorganisms. Various types of bacteria and fungi grow on the walls of buildings, causing erosion and degradation of the building.

Failure in controlling the growth of microorganisms inside the building will cause deterioration of indoor air quality, hence leading to sick building syndrome (SBS). According to Ajam et al (2012), SBS is a major concern in Malaysia. In the United States, the World Health Organization (WHO) discovered that almost 30% of their residents have experienced SBS. According to Syazwan et al. (2009), the building occupants are usually unaware that they been exposed to this syndrome until they experience health issues, like breathing problems. Thus, an indoor air quality assessment is crucial to identify buildings that have SBS. Poor ventilation in the building may leads to the accumulation of spores, bacteria and virus on the surfaces of carpets, curtains, tablecloths or furniture, further polluting the indoor air environment of a building. Several studies have been conducted to mitigate the presence of microorganisms in the indoor air. One of the popular approaches is by using plant extracts containing antifungal properties. Various types of medical plants contain antifungal compounds such as alkaloid. The selection of the plant species for an antifungal activity test should be based on the content of the secondary metabolite, as the secondary metabolites are species-specific. Secondary metabolites play a role in supporting the plant defence mechanism against fungi and bacteria infections. For example, sesquiterpenoid alkaloid that works effectively inhibiting the reproduction of microorganisms. Therefore, this product is introduced by using *S. crispus* as the main resources to inhibit the SBS fungus.

Content

Product Description: This product using plant based where *Strobilanthes crispus* (Pecah kaca) is the main resources. *S. crispus* is locally available and easy to propagate by using stem cutting propagation. Besides that, this product is natural biocide that harmless and nontoxic to human. The antimicrobial nanoparticles-accessible approach is adopted because of effective, low cost and eco-friendly. This product come into 2 product which are spray and additive form which is easy to use and practical.

1. BioC-Spray:

- Immediate effectiveness
 - Green colour
- Non-toxic/ Natural Biocide
 - Low cost (RM5/500ml)
 - Harmless & Non-toxic
 - Practical & Easy to apply
- 36 hours Effective & Efficient

2. BioC-Additive:

- Silver nanoparticles technology
 - Soluble in any paint
 - Clear colour
- Can be applied interior and exterior surface
 - Effective for 5 years.
- Cost effective (RM10/10ml)

Acknowledgement

Special thanks to the Faculty of Earth Science, UMK dan the School of Biological Science, USM for the technical and facilities support.

References

- Ajam S.M.S., B. Salleh, S. Al-Khalil and S.F. Sulaiman, 2012. Antimicrobial activity of spermine alkaloids from *Samanea saman* against microbes with sick buildings. *Int. Conf. Environ., Chem. Bio.*, 49: 150-155
- Syazwan, A.I., J. Juliana, O. Norhafizalina, Z.A. Azman and J. Kamaruzaman, 2009. Indoor air quality and sick building syndrome in Malaysian buildings. *Global J. Health Sci.*, 1: 126-135.
- Abas M A, Hambali K A, Hassin N H, Karim M F A, Ismail L and Rosli H 2020 Antifungal activity of selected Malaysia's local medicinal plants against sick building syndrome (SBS) Fungi, *Asian J. Plant Sci.* 19: 240–245.

SWEET POTATO AND BLACK BEAN PASTA

Nurhanan, AR

Product Development Technology Program, Faculty of Agro Based Industry,
Universiti Malaysia Kelantan, 17600 Jeli, Kelantan.
Institute for Research & Poverty Management (InsPeK),
Universiti Malaysia Kelantan, 16300 Bachok, Kelantan.
nurhanan.ar@umk.edu.my

Nur Azhani Azzaharah, N

Product Development Technology Program, Faculty of Agro Based Industry,
Universiti Malaysia Kelantan, 17600 Jeli, Kelantan.
nurazhaniazzaharah@gmail.com

Highlights: Sweet potato and black bean were incorporated separately in pasta formulations with the aims to improve nutritional values, cooking characteristics and physicochemical properties of the pasta. These vegetables were substituted with flour at the level of 0-20%. All formulated pasta were then subjected for nutritional analysis, cooking characteristics, and texture profile analysis. The formulated pasta with sweet potato and black bean had higher fiber (9-18%), protein (16-18%) and minerals (0.78-0.96%) with lower fat (0.66-0.71%) and moisture (9.8-10.4%) than control. Cooking time decreased for both pasta as shown by lower hardness property compared to control pasta.

Key words: *pasta, sweet potato, black bean, nutritious*

Introduction

Pasta is a famous Italian dish consumed worldwide. A few types of pasta namely spaghetti, macaroni, fettucini, spirals, lasagne are among favourable meals served with flavourful gravy. Traditionally, pasta is prepared using ingredients such as durum wheat, eggs and water. The processes involve in pasta making are mixing, resting, kneading, pressing and lastly drying of the pasta strips. Pasta is being very popular as a delicious family meal and become a signature dish of many cafés and restaurants in Malaysia nowadays which are served as delicious and nutritious food. This study was conducted to produce pasta enriched with sweet potato (*Ipomoea batatas*) and black bean (*Phaseolus vulgaris*).

Sweet potato is rich in carbohydrate, protein, vitamin A, vitamin C, iron, fiber (Mais and Brennan, 2008), β -carotene, and anthocyanin (Bovell Benjamin, 2007; Kosieradzka et al 2002). Sweet potato is also rich in vitamins, phytosterol, isoflavones and amino acids. According to USDA, a 100g of sweet potato will provide 359 kJ energy, 1.57 g protein, 20.12 g carbohydrate and 3 g of total dietary. Meanwhile, *Phaseolus vulgaris* or black bean is an herbaceous annual plant grown worldwide for its edible dry seeds. This bean possess excellent nutritional values, since it is a good source of amino-acids-rich protein, dietary fiber and slow digestible starch (Shiga, et al 2006) and folic acid. According to USDA, black beans are good source of energy, protein dietary fiber and various vitamins and mineral by which a 100 g of cooked boiled black bean can provide 552 kJ energy, 8.86 g protein, 355 mg potassium and 8.7 g dietary fiber.

It was well documented that the lack of dietary fiber intake in our daily diet can cause many health issues such as heart disease, diverticular disease, diabetes, and colon cancer. Dietary fibre helps to maintain body weight and prevent obesity. It was reported that Malaysia has been ranked for having huge numbers of obese populations in South-East Asia region (Lee, 2014). Thus, excellent sources of both soluble and insoluble dietary fibre such as sweet potato and black beans can be used in producing pasta with higher content of dietary fibre. It is an important macromolecules needed in our body to ensure the health of digestive system has lower cholesterol property.

This innovative approach uses sweet potato and black bean separately in pasta preparation. The sweet potato or black bean were either blanched or soaked until soft texture obtained. It is then blended using electronic blender to obtain mushy texture. The pasta was prepared using pasta maker to develop a dough from wheat flour, whole eggs, salts and water. In this project, sweet potato and/or black bean is substituted with flour at 20% level. The pasta is cut before dried using food dehydrator at 60 °C. Pasta fortified with sweet potato and black beans had higher protein, ash, fats and dietary fibre compared to pasta without fortification of these vegetables. Moisture content had decreased in pasta containing sweet potato and black bean suggested potential higher shelf life property of the product. Moreover, the cooking time required for pasta with 5-15% sweet potato and 10- 20% black bean is shorter than the control pasta. Hardness property of formulated with sweet potato and black bean was lower than control pasta, suggesting that pasta formulated with sweet potato and black bean had shorter cooking time. The texture profile analysis in chewiness, gumminess and springiness attributes of sweet potato and black bean past pasta however were not significantly different with that of control. To the best of our knowledge, sweet potato and black bean flour or puree are not yet available in the markets. These two vegetables could improve nutritional values in pasta formulations while reducing its fat content when used at more than 10% level. Furthermore, both sweet potato and black bean pasta required shorter cooking time than control pasta as indicated by firmer texture property shown when being cooked for 10 and 20 minutes. Thus, we recommend that sweet potato and black bean pasta (Figure 1 and Figure 2) to be commercialized in the future. These two agricultural produces could serve as ingredients in baked products to produce nutritious food in the future.

The agricultural and food sector have dependencies with each other to reach sustainability. Our farmers can increase their production when there is a continuous demand from food processing side. Community farming is

example of practices in agriculture and it is an important strategy for reducing food insecurity, increase household income and provide employment (Yusuf et al., 2015). Community farming involving sweet potato and black bean cultivation can be implemented in urban or rural areas with the aims to improve socioeconomic and well-being of the communities. In addition, knowledge transfer programs related to sweet potato and beans cultivation and food processing can also be conducted and translated into practice for significant outcomes. Thus, community farming with the relevant food product development will benefit many farmers and food producers.



Figure 1: Sweet potato pasta



Figure 2: Black bean pasta

Acknowledgement

We are grateful for the support by Faculty of Agro Based Industry.

References

- Lee,P. (2014). Malaysia is fattest country in South-East Asia. The Star Online. <https://www.thestar.com.my/>
- Bovell-Benjamin, A. C. (2007). Sweet potato: A review of its past, present, and future role in human nutrition. *Advances in Food and Nutrition Research*, 52, 1–59.
- Mais, A. & Brennan, C. S. (2008). Characterisation of flour, starch and fibre obtained from sweet potato (Kumara) tubers, and their utilization in biscuit production. *International Journal of Food Science & Technology*, 43(2), 373–379
- Shiga, T. M., & Lajolo, F. M. (2006). Cell wall polysaccharides of common beans (*Phaseolus vulgaris* L.)—composition and structure. *Carbohydrate Polymers*, 63(1), 1–12.
- Yusuf, Sulaiman & Balogun, Olubunmi & Falegbe, Olanike. (2015). Effect of urban household farming on food security status in Ibadan metropolis, Oyo State, Nigeria. *Journal of Agricultural Sciences, Belgrade*. 60. 61-75.

A RAPID DIAGNOSTIC TECHNIQUE FOR DETECTION OF VIRAL DISEASES

Ruqayyah Ainul Bashirah

Laboratory of Vaccines and Biomolecules, Institute of Bioscience, Universiti Putra Malaysia, Serdang 43400, Selangor Darul Ehsan, Malaysia.
ainulbashirah92@gmail.com

**Nurulhuda Najihah Zainal Abidin¹, Nur 'Atikah Abdul Latif¹,
Mariatulqabtiyah Abdul Razak^{1,2}, Kuo Pin Chuang³**

¹Laboratory of Vaccines and Biomolecules, Institute of Bioscience, Universiti Putra Malaysia, Serdang 43400, Selangor Darul Ehsan, Malaysia.

²Department of Cell and Molecular Biology, Faculty of Biotechnology and Biomolecular Sciences, Universiti Putra Malaysia, Serdang 43400, Selangor Darul Ehsan, Malaysia.

³Graduate Institute of Animal Vaccine Technology, National Pingtung University of Science and Technology, No. 1, Xuefu Road, Neipu Township, Pingtung County, Taiwan 912
nurulhudanajihah91@gmail.com, atikahlatif95@gmail.com, mariatulqabtiyah@upm.edu.my, kpchuang@g4e.npust.edu.my

Highlights: Viral detection kit using Loop-mediated Isothermal Amplification (LAMP) technology has a great market value due to its rapidness, simplicity and efficiency. We manipulated this technology to detect the viral diseases of parrots. Detection of these common diseases able to provide an assurance on the health status of high value parrots, and also prevent for potential disease outbreak.

Key words: LAMP, rapid, detection, bird

Introduction

Loop-mediated Isothermal Amplification (LAMP) technique has been used to diagnose various infectious disease, identification and differentiation of pathogenic microorganisms. Detection kit for avian viral detection using the LAMP technique able to detect specific viruses that cause certain diseases in avian species on-site. Parrots are natively found in the Southern Hemisphere and live in the warm areas. It is known for its bright colourful feathers and its intelligence. Thus, it has a higher price among bird breeders and bird lovers. However, the parrot family are susceptible to virus infections such as papillomavirus and polyomavirus. Early detections are needed for an effective treatment, to prevent death of infected birds and for future prevention of potential disease outbreaks.

The Technology

With the development of on-site viral detection kit, it can be used to detect both bird viruses as part of routine healthcare screening and as an early detection in viral infection cases. The product development for the detection kit is taking into account of the condition in the field for sample collection. Thus, only faecal samples are required for the detection.

Impact

The viral detection kit is important to community because it helps in early detection of these viruses that can be fatal to birds. This would also prevent potential outbreaks that may be caused by undetected viral circulation among animals. Moreover, our technology does not require complicated laboratory equipment. It is designed to be simple and it does not require complex technical skills, hence would benefit the clients.

Potential Clients

The marketability of the parrot family is well known especially among pet breeders and bird lovers. Owners of parrots are willing to invest to ensure their pet birds are healthy. Pet breeders also are willing to invest in terms of healthcare of the parrot family to convince potential buyers and to sell their birds at a higher price. Thus, the marketability of the detection kit relies on demands for these birds. Moreover, veterinary facilities and conservation sites specifically in exotic birds such as the parrot family also are in need of this detection kit. This is to ensure specificity in disease diagnosis and to provide the best treatment for the birds. For the conservation sites, this kit will really help in specifically detecting papillomavirus and poliomyovirus diseases, in comparison of its current practice of universal virus screening, which can lead to misdiagnosis and eventually death of precious endangered species of the parrot family.

Market Size and Growth Potential

According to Global Industry Report, the veterinary diagnostic market in 2020 was estimated at USD 5.36 billion globally. The Asia Pacific market is projected to grow at the highest CAGR in the forecast period, due to increase in prevalence of zoonotic diseases, pet adoption, and awareness about animal health. Based on communications with bird clinicians and our international collaborator in Taiwan, there is an exclusive demand for bird virus diagnostic kits in the Europe and Asia Pacific. The global veterinary diagnostic market is expected to grow at 6.1%. However,

the current unprecedented pandemic may affect this numeric estimation. Figure 1 summarises the potentials of this technology.



Figure 1. Specific features of our technology. Analysis on the value proposition, competition, early adopters and high level concept of our product will prepare us for pre-commercialisation.

Acknowledgement

The project was supported by the Fundamental Research Grant Scheme (FRGS/1/2018/STG05/UPM/02/31) with vot number 5540149, by the Ministry of Higher Education Malaysia (UPM). N. N. Z. A. and N. A. A. L. were supported under the Student Graduate Research Scheme (SGRA) from the same grant. R. A. B. was supported under the SGRA from the InnoHub Grant of the Putra Science Park, Universiti Putra Malaysia.

References

- Padzil, M., Halim, N. S. A., Najihah, N., Najian, A. B. N., Abu, J., Isa, N. M., Lau, H. Y. & Mariatulqabtiyah, A. R. (2021). Evaluation of Beak and Feather Disease Virus, Avian Polyomavirus and Avian Papillomavirus of Captives Psittacine Birds in Seri Kembangan, Selangor, Malaysia. *Malaysian Journal of Microbiology*. 17(3), 338-344
- Market Analysis Report. (2019). Companion Animal Health Market Size, Share & Trends Analysis Report by Type, By Product (Vaccines, Pharmaceuticals, Feed Additives), By Distribution Channel, By End Use, And Segment Forecasts, 2019-2026.
- Zanon, Z., Najihah, N., Abu, J. & Mariatulqabtiyah, A. R. (2018). Prevalence of avian polyomavirus from psittacine birds in Klang Valley. *Pertanika Journal of Tropical Agricultural Sciences*. 41(2): 917-924.
- Keikha, M. (2018). LAMP Method as One of the Best Candidates for Replacing with PCR Method. *Malaysian Journal of Medical Sciences*, 25(1), 121-123.

INTEGRATED SOLAR-IoT MONITORING AND PREDICTIVE MAINTENANCE SYSTEMS FOR IRRIGATION (**S-IoTP**)

Hasyiya Karimah Adli

Department of Data Science, Universiti Malaysia Kelantan, 16100 Kota Bharu, Kelantan, Malaysia
Institute for Artificial Intelligence and Big Data, Universiti Malaysia Kelantan, 16100 Kota Bharu Kelantan, Malaysia
hasyiya@umk.edu.my

Khairul Nizar Syazwan Wan Salihin Wong^{1,2}, Muhammad Akmal Remli^{1,2}, Ku Azmie Ku Husin³,

¹Department of Data Science, Universiti Malaysia Kelantan, 16100 Kota Bharu, Kelantan, Malaysia

²Institute for Artificial Intelligence and Big Data, Universiti Malaysia Kelantan, 16100 Kota Bharu Kelantan, Malaysia

³Faculty of Bioengineering and Technology, Universiti Malaysia Kelantan, 17600, Jeli, Kelantan, Malaysia
azmie.g18d013f@siswa.umk.edu.my, nizar.w@umk.edu.my, akmal@umk.edu.my

Highlights: S-IoTP is an integrated prototype system of Internet-of-Things (IoT) with auto-tracking solar panel for irrigation. It consists of auto-track-developed solar panel to power water pump with IoT hardware and software and mobile user interface. Solar panel moved based on sunlight direction to harvest maximum solar output. With IoT software, real-time data of the solar power output was monitored. The predictive analysis for forecasting solar power output based on model-based algorithm using Python to ensure the availability and back-up of electricity supply. **S-IoTP** has an improved solar-IoT design for efficient and sustainable energy performance and constant maintenance of solar farm.

Key words: Solar Energy, Auto-Track, Internet-of-Things, Irrigation, ARIMA model, Prediction

Introduction

Solar-powered irrigation system has attracted enormous attention considering its green energy source and cost-effective power supplies for plantation farms located in rural areas. Insufficient voltage or overvoltage of solar power generation usually occurs especially for states of Malaysia that experience northeast monsoon every year.

Based on Figure, **S-IoTP** consists of auto-track-developed solar panel (1) to power pump for irrigation with IoT hardware (sensors)(2), software (3) and user interface via mobile (4). With IoT sensors, the solar panel moved by following the sunlight direction in order to harvest maximum solar energy output. While, with IoT software, real-time data of panel voltage (vpv) and current (ipv) of the solar panel was monitored. The predictive analysis was conducted to predict solar energy generation based on specific model-based algorithm using Python tool.

PRODUCT DESCRIPTION



The context of this innovation is based on the digitalisation of agriculture, from Industry 4.0 (IR4.0) to Agriculture 4.0. IR4.0 based on Internet of Things (IoT) technology has transformed the production infrastructures such as connected farms, connected tractors and machines. It enables an increased productivity, quality and environmental protection. Agriculture 4.0 is about connectivity which the ability to remotely collect, use, exchange data and publish information on the production processes. Sensor deployments and connectivity enables the users to track the operation, detect early a loss of performance and offer preventive maintenance operations. Additionally, the collected data helps the users to better understanding the needs and usages to improve its line of process.

A wave of IR4.0 will change global production in near future. Future workers need to be highly trained in these emerging technologies. Hence, the current education system needs to adapt to the demands of IR4.0 so that

preparing the students for the future careers. Tomorrow's industry leaders and managers must possess new skill sets to adapt, to manage, and to take advantage of Industry 4.0. They must be able to see beyond the technology can offer and the implications for the society. Business leaders, educators and governments all need to be proactive in up-skilling and retraining people so everyone can benefit from the Fourth Industrial Revolution (Alex Gray, 2016).

S-IoTP has an integrated system of solar energy as green energy to replace fossil fuels that are now facing depletion. With auto-track solar panel, higher efficiency of solar energy can be captured with Improved monitoring performance and maintenance of solar farm via IoT system (Ku Hussin et al., 2021). With **S-IoTP** concept, students can be exposed to prototype-level of IoT-based technology with the usage of various sensors that fit with any application. From there, the students can explore other IoT-based application to be able to see beyond when the concept turns to prototype that can benefit to humankind. As the COVID-19 pandemic has triggered an unprecedented crisis in almost every sector globally, current technologies play a crucial role in keeping society functional during lockdowns and quarantines. With **S-IoTP**, the users can monitor the farm remotely 24/7, keep the farm under surveillance and reduce the need for human workers. Whilts, with data predictive, it can ensure sustainable power for electricity, optimize the irrigation process and water consumption.

To date, the finding based on this prototype was published at international level (scopus) and was received Silver award from previous ECRI. This system was optimized and upgraded from the previous system with predictive analysis in order to move forward for the commercialization. There are 3 parties (companies and organization) that interested with this work. Total cost per year for this whole system is RM 1020 only which possible to sustain until 25 years, with water bill monthly for RM 70 without need for a worker on-site. Compared to traditional process of irrigation, total cost per year is RM 16200 (RM 1350 per month to cover electricity, worker wage and water bill for RM 300, RM 900 and RM 150 respectively).

Acknowledgement (if any)

Special gratitude to Institute for Artificial Intelligence and Big Data (AIBIG) for the facility to complete the project.

References

- Ku Hussin, K.A., Mohd Adenam, N., Mat Yunin, Y.A., Wan Salihin Wong, K.N.S, Mohd Hashim, S.Z. & Adli, H.K. (2021). Monitoring and optimizing solar power generation of flat-fixed and auto-tracking solar panels with IoT system. IOP Conference Series: Materials Science and Engineering, 1-8.
- Gray, A. (2016). The 10 skills you need to thrive in the Fourth Industrial Revolution. Retrieved from <https://www.weforum.org/agenda/2016/01/the-10-skills-you-need-to-thrive-in-the-fourth-industrial-revolution/>. Accessed on 11 July 2021.

SPATIAL FRAMEWORK OF ZERO COVID 19 OUTBREAK FOR SUSTAINABLE HEALTH IN KELANTAN

Amal Najihah Muhamad Nor

Faculty of Earth Science, Universiti Malaysia Kelantan Jeli Campus, 17600 Jeli, Kelantan, Malaysia
amalnajihah@umk.edu.my,

**Rohazaini Muhammad Jamil¹, Hasifah Abdul Aziz¹, Muhamad Azahar Abas¹, Sifi Aisyah Nawawi¹,
Marieanne Christie Leong¹, Kamarul Ariffin Hambali¹, Nor Hizami Hassin¹, Muhammad Firdaus Abdul
Karim¹, Aainaa Syazwani Mohamad Amir Hamzah¹, Wani Sofia Udin¹, Roniza Ismail¹, Nazahatul Anis
Amaludin¹, Mohamad Faiz Mohd Amin¹, Norfadhilah Ibrahim², Abdul Hafidz Yusoff², Nur Hairunnisa
Rafaci³, Nur Hanisah Abdul Malek⁴**

¹Faculty of Earth Science, Universiti Malaysia Kelantan Jeli Campus, 17600 Jeli, Kelantan, Malaysia

²Faculty of Bioengineering and Technology, Universiti Malaysia Kelantan Jeli Campus, 17600 Jeli, Kelantan, Malaysia

³Institute of Environment and Development, Universiti Kebangsaan Malaysia, Bangi Selangor

⁴Faculty Of Computer And Mathematical Sciences, Universiti Teknologi Mara, Bukit Ilmu, 18500 Machang, Kelantan
rohazaini@umk.edu.my, hasifahabdulaziz@gmail.com, azahar.a@umk.edu.my, aisyah.n@umk.edu.my,
marieanne@umk.edu.my, kamarul@umk.edu.my, hizami.h@umk.edu.my, firdaus.ak@umk.edu.my,
syazwani@umk.edu.my, wanisofia@umk.edu.my, roniza@umk.edu.my, nazanis@umk.edu.my,
mohamadfaiz@umk.edu.my, nfadhilah@umk.edu.my, hafidz.y@umk.edu.my, re2_niesa@yahoo.com,
hanisahmalek@gmail.com

Highlights: This study develops a novel spatial analytical framework to understand the COVID-19 occurrence and identify the potential drivers of transmission COVID-19 outbreak. Spatial landscape approach integrated with a correlation and linear regression model was used to investigate the impact of COVID-19 on population density and its drivers as potential virus transmission carriers. There is a strong relationship between population density with infected cases. The COVID-19 risk map model was developed for future strategic planning of Zero COVID-19 for securing the public health, wellness, social and economic by the researchers, planners, and decision-makers.

Keywords: COVID-19; Kelantan Malaysia, spatial framework, linear regression model

Introduction

In Malaysia, the highest cases of COVID-19 is mostly in the city area where the highest populated in the country in Kuala Lumpur city. A similar pattern in the state of Kelantan Malaysia where the highest cases of positive COVID-19 is in Kota Bharu, Kelantan, the capital city of the state of Kelantan. To date, it has reported 141 cases and 3 deaths, which is considered high compared to the other district (Ministry of Health, 2020). Kota Bharu becomes the main development for Kelantan State, which acts as the administrative, commercial, and financial followed by Kubang Kerian as a centre of the institutions and Pengkalan Chepa as an industrial centre. The population in 2016 was about 1.45 million people which increased by 12% from 2010 has encouraged the urban development in Kota Bharu. Consequently, a large population pool may become a potential carrier of disease transmission for a disease to become an epidemic. However, in Malaysia, especially in the state of Kelantan, the spatial-temporal pattern of the COVID-19 outbreak is still unknown and undiscovered. Therefore, this study investigates the impact of COVID-19 on population density and its drivers as potential carriers of virus transmission. This study develops a novel spatial analytical framework to understand the COVID-19 occurrence and identify the potential drivers of transmission COVID-19 outbreak.

A spatial landscape approach (copyright MyIPO: LY2020001803) integrated with a correlation and linear regression model was used to investigate the impact of COVID-19 on population density and its drivers as potential virus transmission carriers. There is a strong relationship between population density with infected cases. The COVID-19 risk map model was developed for future strategic planning of Zero COVID-19 for securing the public health, wellness, social and economic by the researchers, planners, and decision-makers (Figure 1).

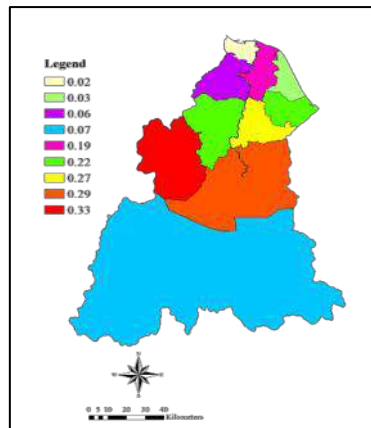

Figure 1: Infected Area Risk Map (Infected Density/Population)

This study will improve the strategic planning that contributes to Zero COVID-19 for helping to increase human health and the ecosystem. This study is relevant to Sustainable Development Goal 11 that i) make cities and human settlements inclusive, safe, resilient, and sustainable and ii) strengthen efforts to protect and safeguard the human health and ecosystem. The knowledge that will be gained from this study is in accordance with Malaysia's National Policy (1998) that is guided by fifteen management strategies, whereby strategy number one (Improve the Scientific Knowledge Base) are specifically addressed in this study.

This innovation research benefits a) researchers, scientists, planners, resource managers and decision-makers by providing decision support tools for strategic planning of Zero COVID-19; creating a current and future COVID-19 information database to be utilised by planners, scientists and decision-makers; low-cost techniques by combining Remote Sensing data and Geographical Information System (GIS) to create current and future COVID-19 information database; the information could be further used to study the relations between epidemic disease, prevention and control; and the concept, framework, methods and practical demonstration of the integrated models in this research may significant for community and stakeholders; b) country by addressing the development of the integrated model approach in a regional and global aspect.

This study has the potential of commercialization through the support of RemotechGeek Company by developing manual education on YouTube, organised workshop and training and consultation. The support and collaboration involve the Health Department, State Agencies and International party that will help future strategic planning of Zero COVID-19 for securing the public health, wellness, social and economic.

Acknowledgement

Special thanks to Universiti Malaysia Kelantan for providing the facilities and grant (R/C19/A0800/00793A/003/2020/00779) (R/STA/A0800/00793A/004/2021/00939).

References

- Ministry of Health (2020). Retrieved from <http://www.moh.gov.my/index.php>. Access on 10th April 2020.
- Ruiz Estrada, M. A., & Koutronas, E. (2020). The Networks Infection Contagious Diseases Positioning System (NICDP-System): The Case of Wuhan-COVID-19. Available at SSRN 3548413.

SUPER PROTECTION GRAPHENE FACE MASK

Thinakaran Narayanan

Institut Kemahiran Tinggi Belia Negara Sepang, Bandar Baru Salak Tinggi, 43900, Sepang, Selangor, Malaysia
thinakaran2014@gmail.com

Kaushik Pal

Bharath Institute of Higher Education and Research (BIHER), 173 Agharam Road, Selaiyur, Chennai, 600073, Tamil Nadu, India,
kaushikphysics@gmail.com

Highlights: Super Protection Graphene Face Mask. When a pandemic affects the respiratory system, there is a potential for a huge increase in demand for face masks. These include widespread public use of cloth masks, as evidenced by the present global spread of COVID-19. However, there is a dearth of information regarding the performance of many regularly used textiles utilised in cloth masks. Notably, there is a requirement to investigate filtration efficiency as a function of aerosol particulate sizes between 10 nm and 10 μ m, which is critical for respiratory virus transmission.

Key words: COVID 19, Graphene, Face mask, Pencil tip, Cotton, Silk

Introduction and Content

When a pandemic affects the respiratory system, there is a potential for a huge increase in demand for face masks. These include widespread public use of cloth masks, as evidenced by the present global spread of COVID-19. However, there is a dearth of information regarding the performance of many regularly used textiles utilised in cloth masks. Notably, there is a requirement to investigate filtration efficiency as a function of aerosol particulate sizes between 10 nm and 10 μ m, which is critical for respiratory virus transmission. These investigations were conducted on a variety of typical fabrics, including graphene, cotton, silk, chiffon, flannel, and other synthetics, as well as their mixtures. Although the filtration efficiencies of various fabrics varied between 5 and 80% and 5 to 95% for particle sizes 300 nm and >300 nm, respectively, the efficiencies improved when additional layers were utilised and when a specific mix of different fabrics was used. The hybrids (such as graphene-cotton-silk) had filtration efficiency greater than 90% (for particles larger than 300 nm). We hypothesise that the hybrids' higher performance is the result of a combination of aerosol layer, mechanical layer, and electrostatic layer-based filtering. Graphene is a nanoscale substance that forms a continuous graphene fabric layer. Nonetheless, when exposed to sunlight for 20-30 minutes, the graphene layer may raise the temperature of the face mask to 80 degrees Celsius. Cotton, the most often used fabric for cloth masks, performs better at higher weave densities (i.e., thread count) and can significantly improve filtering efficiency. Additionally, our research indicates that gaps (as a result of a poor fit of the mask) can result in a 60% reduction in filtering efficiency, emphasising the need for future cloth mask design studies to address concerns of "fit" and leakage while allowing for efficient exhaled air venting. In general, we discover that combining various commercially available textiles in cloth masks can potentially provide significant protection against aerosol particle transmission.

Acknowledgement

Majlis Perbandaran Sepang, Selangor for funding and support this innovation

References

- Pal, K., Asthana, N., Aljabali, A. A., Bhardwaj, S. K., Kralj, S., Penkova, A., ... Gomes de Souza, F. (2021). A critical review on multifunctional smart materials "nanographene" emerging avenue: nano-imaging and biosensor applications. *Critical Reviews in Solid State and Materials Sciences*, 1-17. <https://doi.org/10.1080/10408436.2021.1935717>
- Zaheer, T., Pal, K., & Zaheer, I. (2021). Topical review on nano-vaccinology: Biochemical promises and key challenges. *Process Biochemistry*, 100, 237-244. <https://doi.org/10.1016/j.procbio.2020.09.028>
- V, R., Pal, K., Zaheer, T., Kalarikkal, N., Thomas, S., de Souza, F. G., & Si, A. (2020). Gold nanoparticles against respiratory diseases: oncogenic and viral pathogens review. *Therapeutic Delivery*, 11(8), 521-534. <https://doi.org/10.4155/tde-2020-0071>
- Pal, K., Aljabali, A. A., Kralj, S., Thomas, S., & Gomes de Souza, F. (2021). Graphene-assembly liquid crystalline and nanopolymer hybridization: A review on switchable device implementations. *Chemosphere*, 263, 128104. <https://doi.org/10.1016/j.chemosphere.2020.128104>
- Zaheer, T., Pal, K., & Zaheer, I. (2021). Topical review on nano-vaccinology: Biochemical promises and key challenges. *Process Biochemistry*, 100, 237-244. <https://doi.org/10.1016/j.procbio.2020.09.028>
- Pal, K., Asthana, N., Aljabali, A. A., Bhardwaj, S. K., Kralj, S., Penkova, A., Gomes de Souza, F. (2021). A critical review on multifunctional smart materials "nanographene" emerging avenue: nano-imaging and biosensor applications. *Critical Reviews in Solid State and Materials Sciences*, 1-17. <https://doi.org/10.1080/10408436.2021.1935717>

IComPBag

Azura Sharena Yahaya

National Defence University of Malaysia, Kuala Lumpur, Malaysia
azurasharena@gmail.com

Siti Nor Farhanah Sh Nor Shahidin, Mohd Fahmi Lukman

National Defence University of Malaysia, Kuala Lumpur, Malaysia
farhanah@upnm.edu.my, fahmilukman@gmail.com

Highlights: IComPBag is an award-winning, multipurpose, user friendly, cost efficient and portable inflatable positioning device that prioritizing patient safety. It elevates patient body parts, thus providing optimal position for surgeries involving head, neck, and shoulder. It is suitable to be used in any healthcare facilities. It was invented by healthcare professionals with support from innovative medical device company Mymedikal Healthcare Sdn. Bhd. IComPBag is currently being utilized as a standard positioning device in Malaysia Armed Forces hospitals and used successfully in more than 200 surgeries without any complications.

Key words: *patient positioning device, inflatable, surgery*

Introduction

IComPBag is a portable, reusable/disposable, inflatable positioning device that is design to elevate patient body parts, thus providing optimal position for surgeries especially in the discipline of maxillofacial, otorhinolaryngology-head and neck, orthopedic, endocrine, and obstetric. It was invented in 2017 by 10 healthcare professionals with different background lead by Dr. Azura Sharena binti Yahaya. It was a joint effort between National Defence University of Malaysia and Royal Health Corps, Malaysia Armed Forces. In 2019, Mymedikal Healthcare Sdn. Bhd. (MHSB), a medical device company agreed to develop, manufacture, support, and market the first 500 products. Patent application was filed in 28th of December 2017 with application number of PI 2017705115. There is no product with similar concept and features in the market and hence IComPBag serves as an inventive innovation and alternative to the widely available standard positioning devices.

Content

IComPBag comprises of an inflatable bag, an elongated connecting tube, a hand-held pump, a puncture tube, a safety clamp and adjusting screw. Inflatable bag is made from Renolit Solmed Medituub, a similar material used for critical blood contact devices, in which make IComPBag safer for patient and health care workers. It is gas impervious and has non-blocking properties; this overcomes problem of material stickiness, hence make it easier to inflate and store. It has non-kinking properties, excellent transparency, and suitable for steam, ETO and gamma sterilization. It causes less irritation to patient's skin and as a result lesser risk of infection. Due to soft and flexible feature of the material, the force exerted by patient's body can be spread evenly and does not form pressure points. Inflatable bag is rectangular in shape and both of its short edges have a double seal and extra compression points; hence it could withstand high pressure exerted by the patient's body weight. To distribute pressure evenly, all angles are curve in shape. A 750mm in length, circular connecting tube is used to deliver air from a hand-held pump to the inflatable bag and it is the optimal distance between the operator and the patient. The elongated connecting tube is connected to the rubber, ovoidal hand-held pump that is flexible enough to be repeatedly squeezed. IComPBag has a specially designed extra puncture tube serves as an alternative access for air inlet/outlet and a safety clamp to further prevent air leak. The adjusting screw is used as a valve to control air pressure of the inflatable bag.

In the medical field, patient positioning system is imperative as it contributes to the required conditions for a successful operation. In addition, appropriate posture would protect the patient from injury during surgery. As it names indicate, a patient positioning system is a group of medical devices such as gel pads, straps and sandbags which position the patient in a particular posture. One of the widely examples used in patient positioning system, particularly for neck extension, is a shoulder gel pad. Using gel pads as positioning devices would generally require the patient to be anaesthetized first, in which the anaesthesia medications would produce muscle paralysis to facilitate tracheal intubation; an endotracheal tube shall be inserted into the patient's trachea to maintain an open airway. Subsequently, with assistance by OT personnel, the patient is place in a desired position as indicated by the surgeon. Any excessive movement during this period may lead to dislodgement of the endotracheal tube and subsequently, patient only source of oxygen from the anaesthesia machine discontinued. Minimum three operating room (OR) personnel (medical assistants, staff nurses) are required to position a patient under anaesthesia and this consume more time. Shoulder gel pad also has many sizes to cater patient with different ages and body weights. Hence, it is desirable to have a proper apparatus and inventive method for patient positioning system which can mitigate the above-mentioned problems.

While the patient still awakes and lie supine onto the operation table, IComPBag is positioned under his/her shoulder. After induction of anaesthesia, the operator inflates the IComPBag by repeatedly pressing the hand-held pump. When the air pressure is sufficient, the operator turns off the adjusting screw to close the air channel and thus preventing air escape from inflatable bag. Such procedure provides a safer environment for the patient as the operator does not have to elevate any of patient body parts after anaesthesia, which reduces the risk of endotracheal tube dislodgement. Only one OT personnel is required to inflate IComPBag in less than 2 minutes, hence make the positioning procedure time efficient. Moreover, the operator can easily adjust the size of the IComPBag by either pumping in more air to inflate the bag or turning the adjusting screw to release the air. This provides optimal position for the surgery, make it safer and faster.

IComPBag could be marketed to all level of hospitals that provide surgeries involving head, maxillofacial, neck, and shoulder. IComPBag is also very suitable to be used for any procedures outside operation theatre such as radiological and emergency procedures. IComPBag has been used extensively in Malaysia Armed Forces hospitals especially Tuanku Mizan Armed Forces Hospital Kuala Lumpur for various types of surgical procedures with involvement of more than 200 patients of all age groups and body sizes. A survey was conducted among anaesthesia staffs in Tuanku Mizan Armed Forces Hospital operation theatre; all respondents agreed that it was easier and faster to position a patient using IComPBag and require less manpower. They found out that IComPBag was light, portable, adjustable, durable, and easy to store. No complications such as dislodgement of endotracheal tube, allergy and pressure marks were reported. For all the advantages and benefits, it is easy to understand why IComPBag has won 3 special awards, 6 golds and 1 silver, locally and internationally.

In conclusion, IComPBag is a Malaysian made, cost effective, easy, portable, and safe innovative inflatable positioning medical device that is suitable to be used in many types of surgery at any level of healthcare facilities.

References

- Miller, H. J. (2004). *Tobler's First Law and Spatial Analysis*. 94(November 2003), 284–289.
- Tobler, W. R. (1970). A computer movie simulating urban growth in the detroit region. *Economic Geography*, 46, 234–240.
<https://www.jstor.org/stable/143141>
- Ya'acob, S. H., & Mar Iman, A. H. (2020). The Spatial Influence of Environmental and Anthropogenic Factors on The Pattern of Air Pollution in Malaysia. *IOP Conference Series: Earth and Environmental Science*, 549(2020). <https://doi.org/10.1088/1755-1315/549/1/012011>

MICROENCAPSULATED ASTAXANTHIN FACE SERUM

Nik Nur Azwanida Binti Zakaria

Universiti Malaysia Kelantan, Jeli, Kelantan, Malaysia
azwanida@umk.edu.my

Nurul Najwa Izzati Binti Mohd Zakuwan, Zuharlida Tuan Harith

Universiti Malaysia Kelantan, Jeli, Kelantan, Malaysia
izzatif17a0103@siswa.umk.edu.my, zuharlida@umk.edu.my

Highlights: Serum is a skincare product that can give a quick result to the skin within a few weeks of application. Face serum contains high concentrated emulsion and contains small particle molecules that can penetrate the skin, thus delivering instantly noticeable results. Therefore, face serum formulation's stability needs to be maintained to increase its effectiveness to the consumer's skin. Astaxanthin is a secondary plant metabolite with various bioactivities such as antimicrobial, antioxidant, and anti-inflammatory effects that are beneficial to the skin. This current invention utilizes microencapsulated astaxanthin as an active ingredient in face serum that resulted in higher stability of the active ingredient in the final product formulation.

Key words: *astaxanthin, face serum, physicochemical properties*

Introduction

Serum is a skincare product containing a gel or lightweight lotion or moisturizing consistency that penetrates the deeper skin to deliver the active ingredients. The ingredients in the serum can help the skin to become firmer, and can increase moisture levels to maintain healthy skin balance (Ojha et al., 2019). All skincare products, including moisturizer, cleanser, cream, anti-wrinkle or anti-aging product, or skin serum products must provide specific functions such as antioxidants, cell-communicating ingredients, and to help maintain skin health. However, some of these active ingredients are not stable when incorporated in the final serum formulation, including astaxanthin.

Astaxanthin is a xanthophyll carotenoid; a secondary plant-metabolite present in bacteria, plant, and yeast (Davinelli et al., 2018). This pigment is reflected in the flesh and skin of aquatic animals that consume the algae such as salmon, red trout, red sea bream, flamingoes and crustaceans. *Haematococcus pluvialis* (algae) is known to produce high amount of astaxanthin in stressed environment, such as prolong exposure to sunlight, high salinity water and restricted nutrients availability (Boussiba & Vonshak, 1991). Moreover, astaxanthin has been reported to be 10 times stronger than other carotenoids including zeaxanthin, lutein, canthaxanthin, and β -carotene, and 100 times greater than that of α -tocopherol (Kurashige et al.1990, Naguib 2000).

Thus, astaxanthin have high potential to be commercialized as an active ingredient in the formulation of face serum because its benefits to the skin, such as antioxidant properties, increases skin moisture, and reduces facial wrinkles. However, this carotenoid also has stability problems when incorporated into skincare formulation such as face serum. Therefore, this present project evaluates the stability of face serum incorporated with microencapsulated astaxanthin.

Content

Description of innovation

This current invention utilizes microencapsulated astaxanthin or astaxanthin beads (Figure 1) as active ingredients in face serum that resulted in higher stability of active ingredients in the final product formulation. The astaxanthin actives are protected in the microcapsules that provide longer shelf life of the final products.



Figure 1: Microencapsulated astaxanthin or astaxanthin beads

Background of innovation

Face serum contains a mixture of concentrated active ingredients and emulsion of different physicochemical properties. Commonly, the formulation of face serum consists of active ingredients with high potency that have high tendency to deteriorate. Astaxanthin is a lipid soluble pigment that is naturally produced by *Haematococcus pluvialis* (algae) and has been shown to have high potency compared to other carotenoids (Naguib 2000). In this present study, astaxanthin was attempted to be formulated in personal care product to obtain a stable and effective formulation. It is very crucial to obtain formulation that could preserve the activity of the active ingredients and the intended action of the face serum to maintain the quality of the product.

Advantages

The microencapsulated astaxanthin developed has higher stability, thus able to prolong the shelf life of the finished product. Furthermore, this invention will provide alternative application of astaxanthin in personal care products development and additional aesthetic value to the finished product with astaxanthin beads floating inside the serum.

Commercial value

This invention has high potential to be commercialize as natural-based personal care product. Moreover, organic and natural-based based cosmetics have been shown to have high market demand worldwide. Statistics on skincare market shows that the skincare industry is estimated to be valued at 180 billion by 2024 (Anwari, 2009).

Acknowledgement

Authors would like to thank Faculty of Agrobased Industry, Universiti Malaysia Kelantan that provides the facilities where this research was performed.

References

- Anwari, M. (2019). Optimization, Stability and Characterization of Face Serum Formulation. *Food Quality and Preference*, 1(9), 160–164.
- Davinelli, S., Nielsen, M. E., & Scapagnini, G. (2018). Astaxanthin in skin health, repair, and disease: A comprehensive review. *Nutrients*, 10(4), 1–12.
- Kurashige M, Okimasu E, Inoue M, Utsumi K. (1990). Inhibition of oxidative injury of biological membranes by astaxanthin. *Physiol. Chem. Phys. Med. NMR*, 22,27–3821.
- Ojha, S., Chadha, H., & Aggarwal, B. (2019). Formulation and Evaluation Of Face Serum Containing Bee. *World Journal of Pharmaceutical Research*, 8(2), 1100–1105.
- Naguib YM. (2000).Antioxidant activities of astaxanthin and related carotenoids. *J. Agric. Food. Chem.*,48,1150–1154.

TOMCAT TRAP

Nik Azida binti Abd Ghani

Politeknik Kota Bharu, Kota Bharu, Malaysia
nikazida5@yahoo.com

Juli Suzlin binti Jalaluddin, Syed Zainal Abidin bin Syed Noor Wahid, Muhammad Azham Aizil bin Othman, Nurul Durrani binti Afandi, Hanis Izzati binti Roslan

Politeknik Kota Bharu, Kota Bharu, Malaysia
julisuzlin@gmail.com; azhamaizil17othman@gmail.com; byydurra00@gmail.com; syedabidin21@gmail.com; hanisizzati0326@gmail.com

Highlights: Tomcat Trap is designed to overcome the attacks of Charlie ants or tomcats, particularly in the campus residences in Politeknik Kota Bharu. Tomcat trap aims to reduce tomcat's population and hence curb the tomcat attacks. This trap is free from hazardous chemicals and therefore is safe to the environment. It is safer than aerosol pesticides or insect repellent. Tomcat trap is mobile, durable and needs less maintenance. Tomcat Trap can be produced at a larger quantity to benefit from economies of scale. Potential markets are wide because many campuses in Malaysia are affected by tomcats.

Key words: *Charlie ant, Tomcat trap, LED, environmental friendly*

Introduction

Charlie ants or tomcat measure 7 to 8 mm long and has red or orange body and its head is black. Tomcat attacks has always been debated among Politeknik Kota Bharu students, particularly those residing in campus. The attack victims will suffer from inflammation and rashes as well as itchiness on their skin (Muhammad Fahrur, 2019). According to Asbaquez (2015), tomcats do not bite or sting. More often, the toxic liquid from the ants may leave scars behind. Tomcats are nocturnal, attracted to lights and usually attack at night,

Tomcats live at damp places and bushy plants (Puti Yasmin, 2019). After a thorough study of the habitat, characteristics and behaviour of the insect, the researcher designed Tomcat Trap. This trap is designed to reduce the population of tomcats and thereby reduce the tomcat attacks. The usage of LED light attracts the ants towards the trap and once they enter the trap, they are glued to the trap.

Product Development

The main material used in the development of Tomcat Trap is Perspex to make the container or box. The Perspex is cut and then attached together using hot glue. A hot glue gun is used to apply the hot glue. Two LED light is attached to the prototype using hot glue. This light will lure the insect to the trap as tomcat is attracted to lights. An adhesive sticker is attached at the bottom of the box. Once the ants enter the trap, they would get stuck and not able to free themselves from the trap. Figure 1 below shows the materials needed to produce the prototype.



Figure 1 Materials to Produce Tomcat Trap

Significance of Product

Tomcat Trap is environmental friendly, as it uses materials that are 100% free of chemicals. This trap is mobile, and easy to move to any places, especially areas that are prone to be attractive to tomcats. It is very durable and only need to replace the adhesive sticker from time to time. Figure 2 shows the prototype of Tomcat Trap.



Figure 2 Prototype of Tomcat Trap

Feasibility Study of Product

A total of 80 students participated in a survey, which was conducted to gauge the needs of the prototype and to measure the anxiety of students of Politeknik Kota Bharu on tomcat attack. Majority of respondents (70 respondents) feel that tomcat attack is dangerous. A total of 42 respondents had been attacked by tomcat. Most of the respondents suffered inflammation on their skin (29 respondents), itchiness (25 respondents) and 23 respondents did not have any effects after being attacked by tomcat.

Marketability of Product

The cost of producing Tomcat Trap prototype is quite expensive. However, the cost of production may be reduced if it is produced in a bigger quantity. This trap has commercial potential due to the tomcat attacks is a common problem especially in campus residences in Malaysia. The usage of Tomcat Trap is also safe to the environment as it uses materials that are 100% free of chemicals. Tomcat Trap is easy to use, light weight and can be shifted or moved to any places as deemed necessary.

In the future, the researchers hope to promote Tomcat Trap using social media such as Instagram, Whatsapp and Facebook. The product features and packaging will be improved to appeal to prospects and customers and ease postage and delivery.

References

- Asbaquez.com. (2015). Tomcat liquid danger and how to prevent it. Accessed on 24 June 2021 from <https://asbaquez.blogspot.com/2015/10/tomcat-liquid-danger-and-how-to-prevent.html>
- Muhammad Fahrur Safii. (2019). Bahaya Semut Charlie, Berikut Fakta dan Cara Penanganannya. Accessed on 24 June 2021 from <https://hot.liputan6.com/read/3997493/bahaya-semut-charlie-berikut-fakta-dan-cara-penanganannya>
- Puti Yasmin. (2019). 5 Fakta Semut Charlie dan Cara Pengobatannya. Accessed on 24 June 2021 from <https://health.detik.com/berita-detikhealth/ d-4599130/5-fakta- semut-charlie-dan-cara-pengobatannya>.

INNOVATIVE TREATMENT MANAGEMENT OF NOTOEDRIC MANGE WITH A COMMERCIAL GAMAT OIL PREPARATION IN CATS

Siti Nur Amira binti Zambri

Universiti Malaysia Kelantan, Kota Bharu, Malaysia
 miazambri@gmail.com

Jasni bin Sabri, Abd Rahman bin Aziz, Ibrahim Abdul-Azeez Okene

Universiti Malaysia Kelantan, Kota Bharu, Malaysia
 jasni@umk.edu.my, abdrahman@umk.edu.my, ibrahim.az@umk.edu.my

Highlights: Six stray cats with Notoedric mange, a disease that can spread to humans (zoonoses) and cause itchiness (pruritic), showed complete healing and absence of the causative *Notoedres cati* from the healed skin, when applied with the Gamat oil preparation. Control cats with mange and without the Gamat application, remained with the skin abnormalities (mange) that caused itchiness and self-inflicted wounds to the suffering cats. This paper shares the innovation of treatment management of mange in cats using a locally available and cheap sea herbal Gamat product. The study signifies the potential usage of Gamat, for mange total healing in cats and implies its future significance in the veterinary practice that supports this herbal industry in Malaysia.

Key words: *Notoedric mange, Notoedres cati, Gamat, Complete healing, National herbal industry*

Introduction

Notoedric mange is a very contagious itchy skin ailments (Notoedric mange) in cats and kittens caused by a skin parasite, *Notoedres cati* (Sivajothi et al., 2013; Weeks et al, 2019). This contagious disease can spread to humans, especially cat owners, causing a very uncomfortable itchy rashes at the legs and arms. This can lead to bacterial infection and fever complications from scratching (Mullen, et al., 2002). Ivermectin is the usual choice to treat mange in cats. However, ivermectin had been reported to cause toxicity in kittens (Bowman, 2014), which means that the drug is potentially unsafe and the affected cats may not respond to future treatments (developed resistance) with ivermectin.

The locally available sea cucumber (*Stichopus variegatus*) or Gamat, which importantly contributes to the herbal industry in Malaysia, is a widely used traditional medicine with anti-bacterial, anti-fungal and wound healing benefits in humans (Pangestuti and Arifin, 2017). However, the possible anti-parasitic and healing effects of Gamat in humans and companion animals, especially in cats, are still unknown.



This information shares the mange treatment management innovation, proven in an experimental study to completely heal Notoedric mange in cats, and therefore, potentiate its application in veterinary practice in the future. Its application will support the local industry and embraces the national slogan "Buy Malaysian Products First".

Experimentation Towards the Innovative Treatment Management

Six stray cats with characteristic mange skin changes equally and randomly divided into 2 groups, one control group that did not receive treatment and the experimental group were treated with a commercial Gamat oil preparation. The efficacy of the Gamat oil preparation was evaluated based on the absence of *Notoedres cati* mites upon skin scraping post-treatment and the progression of healing of the mange throughout the 15 days of topical application. Generally, cats treated with Gamat oil showed significant (p -value <0.05) improvements (Table 1). Gamat-treated group also revealed significant reduction (p -value <0.05) to absence of mites at the affected skin.

Table 1: Progressive Skin Healing of the Gamat Treated Cats

Gamat Application	Observation After Treatment	Images of Healing Progression
Day 1	<ul style="list-style-type: none"> Mange with hair loss at the ears and head. Mange on the ear pinna, head and face. Scratch wound on the ear pinna (asterisk). 	

Day 3	<ul style="list-style-type: none"> • Detachment of mange (scabs and crusts) on the ear pinna, head and face. • Early healing indicated by reddening (inflammation) of the skin at sites of mange detachment. • Early healing of the scratch wound on the ear pinna. 	
Day 7	<ul style="list-style-type: none"> • Skin reddening has resolved. • Presence of early hair re-growth on the ears, head (asterisk) and face. 	
Day 15	<ul style="list-style-type: none"> • Complete healing of mange lesions. • Progressive hair re-growth on ears and head. 	

The Successful Innovative Treatment Management

The treatment innovation involves treating Notoedric mange with a commercial Gamat oil preparation registered under the National Pharmaceutical Regulatory Agency (NPRA), Ministry of Health Malaysia. The Gamat oil has a concentration of 71% *Stichopus variegatus* extract.

The Gamat oil was administered topically on the affected region of the ear pinna, head and face. Using a glove, the Gamat oil is massaged gently on all affected regions until the oil is evenly spread. Our study had showed that for complete healing of mange, the Gamat oil should be applied twice daily (morning and evening). Two drops of the oil (0.05ml per drop) were applied for 15 days. Two drops on each affected site should be employed.

The innovated treatment management when further tested in another 3 cats with severe mange showed similar successful results.

Significance of the innovation

This study firstly reports that Gamat oil preparation is anti-parasitic and caused complete mange healing and hair regrowth in cats. This innovation has health, animal welfare, zoonosis prevention, industry promoting and economic significance.

Cats with mange are further prevented from sufferings and the disease spread to humans is prohibited. The Gamat is easily available because it is locally harvested. Therefore, the study can promote the Malaysian Gamat industry to prosper when the demand for Gamat penetrates the Veterinary market. The Gamat oil treatment is very economical and fast acting. The cost of treatment for each cat is only RM1.08 for 2 weeks duration of complete healing and hair regrowth. The usual clinical mange treatment package (without Gamat) can cost up to RM185/- per cat (source: Veterinary Clinic) with healing duration from 2 to 6 weeks. The potential of Notoedric mange treatment using Gamat in the veterinary sector is quite promising. It can replace ivermectin and prevents ivermectin resistance that leads to treatment failure. Further researches on Gamat application for animal diseases are much recommended.

Acknowledgement

The author is grateful to the supervisors for their guidance. The supports from family, friends and the Faculty of Veterinary Medicine, UMK are much appreciated.

References

- Bowman, A. (2014). *Notoedres cati*. Retrieved from; <https://www.aavp.org/wiki/arthropods/arachnids/astigmata/notoedres-cati/>
- Mullen, G., & O'Connor, B. (2019). *Medical and Veterinary Entomology* (3rd ed., pp. 533-602). Academic Press.
- Pangestuti, R. & Arifin, Z. (2017). Medicinal and health benefit effects of functional sea cucumbers. *Journal of Traditional and Complementary Medicine*. 8. 10.1016/j.jtcme.2017.06.007.
- Sivajothi, S., Sudhakara Reddy, B., Rayulu, V., & Sreedevi, C. (2013). *Notoedres cati* in cats and its management. *Journal of Parasitic Diseases*. doi:10.1007/s12639-013-0357-7.
- Weeks, E., & Kaufman, P. (2019). Mange in Companion Animals. Retrieved from <https://edis.ifas.ufl.edu/in953>.

ANTIBIOFILM PROPERTIES OF GRAPHENE OXIDE AGAINST STAPHYLOCOCCUS AUREUS ISOLATED FROM BOVINE MASTITIS

Nor Fadhilah Kamaruzzaman

Fakulti Perubatan Veterinar, Universiti Malaysia Kelantan, 16100 Kota Bharu Kelantan
norfadhilah@umk.edu.my

Liang Vivian, Shamsaldeen Ibrahim Saeed

Fakulti Perubatan Veterinar, Universiti Malaysia Kelantan, 16100 Kota Bharu Kelantan
Shams88ns@gmail.com

Highlights: This invention describes the potential application of graphene oxide against *S. aureus* biofilm that can be useful for the treatment of bovine mastitis. Bovine mastitis caused by *Staphylococcus aureus* (*S. aureus*) is a disease characterised by the inflammation of the mammary gland, which affected the quality of milk, leading to huge economic loss in the dairy industry. Antimicrobial treatment has only been partially effective due to the ability of *S. aureus* to produce biofilm that limits penetration of antimicrobial¹

Key words: Bovine mastitis, graphene oxide, anti-biofilm

Introduction

Bovine mastitis caused by *Staphylococcus aureus* (*S. aureus*) is a disease characterised by the inflammation of the mammary gland, which affected the quality of milk, leading to huge economic loss in the dairy industry. Antimicrobial treatment has only been partially effective due to the ability of *S. aureus* to produce biofilm that limits penetration of antimicrobial¹. Thus, it is important to find an alternative antimicrobial candidate that is effective against *S. aureus* biofilm. Our innovation explore the potential application of graphene oxide (GO) as anti-biofilm towards *S. aureus* biofilm model. GO is a carbon-based nanoparticle that has a hexagonal or honeycomb-like structure with single-atom thickness and a 2-dimensional (2D) sheet of sp²-bonded carbon atoms that are densely packed in a honeycomb structure with oxygen-containing functional groups such as hydroxyl (-OH), alkoxy (C-O-C), carbonyl (C=O), the carboxylic acid (-COOH)². Three *S. aureus* isolates from bovine mastitis cases were recultivated and assessed their ability to form biofilm. The formed biofilm was stained with crystal violet and quantified using spectrophotometer at 550nm. Following that, a range of GO concentration from 0.5 ug/mL to 1000 ug/mL was added to the biofilm. GO as low as 125 ug/mL can disrupt the biofilm structure, evidenced by reduction of the crystal violet absorbance following the treatment. The ability to disrupt the biofilm structure could be due to interaction between the GO oxidative functional group with the polymeric substances on the biofilm, thus destabilizing its structure. GO is considered a cheap material, easy to obtain, stable in room temperature, and soluble in water, thus provides advantages for further formulation³. In conclusion, GO has anti-biofilm activities that could be further investigated and developed to be part of the mastitis treatment in dairy animal.

Acknowledgement

We thank Faculty of Veterinary Medicine, UMK for providing facility for the project.

References

- Guimarões, J. L., Brito, M. A., Lange, C. C., Silva, M. R., Ribeiro, J. B., Mendonça, L. C., ... & Souza, G. N. (2017). Estimate of the economic impact of mastitis: A case study in a Holstein dairy herd under tropical conditions. *Preventive veterinary medicine*, 142, 46-50.
- Anand, A., Unnikrishnan, B., Wei, S. C., Chou, C. P., Zhang, L. Z., & Huang, C. C. (2019). Graphene oxide and carbon dots as broad-spectrum antimicrobial agents—a minireview. *Nanoscale horizons*, 4(1), 117-137.
- Smith, A. T., LaChance, A. M., Zeng, S., Liu, B., & Sun, L. (2019). Synthesis, properties, and applications of graphene oxide/reduced graphene oxide and their nanocomposites. *Nano Materials Science*, 1(1), 31-47.

ANTI-PSORIASIS COSB (Catharanthus roseus extract, Olive oil, Shea butter & Beewax) OINTMENT

Sujej Kumar Rajendren

Faculty of Veterinary Medicine, Universiti Malaysia Kelantan, Kota Bharu, Kelantan
kumar@gmail.com

Chooi Kah Loong, Abdul Rahman Bin Aziz, & Nor Fadillah Binti Kamaruzzaman

Faculty of Veterinary Medicine, Universiti Malaysia Kelantan, Kota Bharu, Kelantan
Kahloong.d16a0008@siswa.umk.edu.my, abdrahman@umk.edu.my & norfadillah@umk.edu.my

Highlights: Psoriasis is an immune mediated skin disorder where cells that are not fully mature build up rapidly on the surface of the skin causing inflammation. There is no cure for psoriasis but remission can be achieved with the usage of corticosteroids which comes with many side effects which may aggravate psoriasis. *Catharanthus roseus* extract, Shea butter, bee wax, and olive oil (COSB) have wound healing properties and have demonstrated modulation of TGF- β 1 and VEGF-a which is responsible for the skin regeneration process. Commercialisation of this ointment would benefit many psoriasis patient in term of soothing the skin inflammation and essentially skin regeneration.

Key words: anti-psoriasis, *Catharanthus roseus*, bee wax, shea butter, olive oil

Introduction

Psoriasis is a chronic immune-mediated skin disease that is known to be the most prevalent autoimmune disease in humans, and rarely observed in animals. It was estimated that 2%-5% of the world's population suffered from psoriasis (Duffin *et al.*, 2008). The exact etiology and pathogenesis of psoriasis still remains unknown but few researches have done to determine the mechanism of psoriasis. Psoriasis associated with excessive cell division of keratinocytes which leads to flaky, inflamed skin.

Catharanthus roseus, also known as Madagascar periwinkle has been used to treat psoriasis traditionally in West Bank of Palestine. An in vitro study done using *C. roseus* extract, showed positive result (Pattarachotanant *et al.*, 2014).

Beewax, olive oil and shea butter demonstrated wound healing and anti-inflammatory properties with modulation of TGF- β 1 and VEGF-a which responsible for skin regeneration process (Kai In *et al.*, 2017; Bayir *et al.*, 2018).

The objective of this innovation is to alleviate discomfort, itching, inflammation and pain in psoriasis patient and ultimately leads to skin regeneration.

Content

Description of innovation

COSB ointment, upon testing on mice with imiquimod induced psoriasis demonstrated significant reduction in erythema and skin flakiness and regrown dorsal hair after 7 days of treatment with COSB ointment. The same outcome was yielded when hydrocortisone (Corticosteroid topical). cream is being used.



Figure 1: Mice treated with COSB and corticosteroid demonstrate similar outcome in term of fully regrown hair, significantly reduced skin flakiness and skin redness.

Histopathologically, the mice treated with COSB ointment showed similar inflammatory cells infiltration compared to mice treated hydrocortisone (Corticosteroid topical). Besides that, in term of histopathological psoriasis parameters (parakeratosis, hyperkeratosis and Munro's abscess scoring) mice treated with COSB ointment demonstrated significantly low scoring compared to untreated mice. Thus, gross evaluation and histopathological evaluation exhibit effectiveness of this ointment toward mice induced with psoriasis.

Background of the innovation

The existing psoriatic treatment which is mainly corticosteroid topical application, comes together with multiple side effects and sometimes might aggravate the symptoms. The purpose of this innovation is to sooth the inflammation, control the itch and ultimately regenerate normal skin tissue without any side effects which may aggravate psoriasis. Probably, during commercialization it can be marketed as daily body lotion/ointment.

Advantages of your innovation

There is no treatment for psoriasis. The only way is to reduce the inflammation and itch due to uncontrolled proliferation of skin layers. In research setting, COSB ointment proven to reduce inflammation and itch in mice. After clinical trial, COSB ointment can be commercialized and can be marketed through dermatologist in Malaysia.

Acknowledgement

We are grateful for FPV, UMK for allowing to conduct this research in their animal research facility, lab technicians and fellow UMK veterinary students year 2021.

References

- Duffin, K. C., Chandran, V., Gladman, D. D., Krueger, G. G., Elder, J. T., Rahman, P. (2008). Genetics of psoriasis and psoriatic arthritis: update and future direction. *J Rheumatol*, 35(7):1449–53.
- Pattarachotanant, N., Rakkhitawatthana, V., & Tencomnao, T. (2014). Effect of *Gloriosa superba* and *Catharanthus roseus* Extracts on IFN- γ -Induced Keratin 17 Expression in HaCaT Human Keratinocytes. *Evidence-Based Complementary and Alternative Medicine*, 2014, 1–11
- Bayir, Y., Un, H., Ugan, R. A., Akpınar, E., Cadırcı, E., Calık, I., & Halıcı, Z. (2019). The effects of Beeswax, Olive oil and Butter impregnated bandage on burn wound healing. *Burns : Journal of the International Society for Burn Injuries*, 45(6), 1410–1417.
- Lin, T. K., Zhong, L., & Santiago, J. L. (2017). Anti-Inflammatory and Skin Barrier Repair Effects of Topical Application of Some Plant Oils. *International journal of molecular sciences*, 19(1), 70.

AUTOMATED SCREENING AND CELLS COUNTING SYSTEM FOR LEUKAEMIA AND MALARIA

Aimi Salihah Abdul Nasir

Universiti Malaysia Perlis, Perlis, Malaysia
aimisalihah@unimap.edu.my

Thaqifah Ahmad Aris, Mohd Yusoff Mashor, Zeehaida Binti Mohamed

Universiti Malaysia Perlis, Perlis, Malaysia
Universiti Sains Malaysia, Kubang Kerian, Malaysia
thaqifah@studentmail.unimap.edu.my, yusoff@unimap.edu.my, zeehaida@usm.my

Highlights: Leukaemia and malaria are serious global health problems that cause more death than any other blood diseases. Automated Screening and Cells Counting System for Leukaemia and Malaria with mobile phone notification is developed as an alternative tool for manual counting procedure. This system consists of image processing facilities that automatically performs WBCs and parasite counting, as well as integration with mobile phones to inform the person in charge of the patients. With this system, automated cell counting is more practical compared to manual procedures as it is fully assessed by software with less time consumption and accuracy of up to 97%.

Key words: *Leukaemia, malaria, cells counting, screening system, mobile phone notification.*

Introduction

Leukaemia is known as a cancer originating from the blood or bone marrow. The bone marrow acts as a place for producing blood cells in the body. Basically, leukaemia will occur when there is a problem with the production of blood cells. It is most likely to affect people over the age of 55 years, but it is also the most common cancer in those aged under 15 years. Meanwhile, malaria is a mosquito-borne disease caused by a parasite. This parasite is transmitted to people through the bites of infected female *Anopheles* mosquitoes. Generally, some symptoms may occur after being infected such as fever, chills and flu illness. It may become severe and if left untreated can cause severe complications and death.

Leukaemia presence can be detected with the growth number of abnormal white blood cells (WBCs) while parasite presence in the blood may result in malaria. Currently, the most economic and reliable diagnosis which is based on microscopic examination of blood slides still remains the gold standard for the laboratory diagnosis of malaria. The traditional method of manual count under microscope yields inaccurate results. The possibility of faulty detection due to human error may arise. During the process of WBCs count, the haematologists will be in a high physical strain in order to complete the process. It takes a lot of focus to examine just one blood sample. The consequences from the physical strain cause the haematologists to experience an eye fatigue. On the contrary, other different methods in detecting leukaemia and malaria are bone marrow test, computed tomography (CT) scan, rapid diagnostics test (RTD) and magnetic resonance imaging (MRI) scan.

Subsequently, the manual recognition method is time consuming and effortful especially in situations where large numbers of samples require reliable analysis. Just within 48 to 72 hours, the parasites inside the red blood cells multiply causing the infected cells to burst open. It is crucial to detect the presence of parasites in just a short time to reduce the possibility for the patients to become more severe. Next, the lack of research in terms of malaria density based on parasites counting is one of the main problems. In this case, most of the research only focuses on identifying the type of species for the *Plasmodium* (P.) parasite which consist of *P. falciparum*, *P. vivax*, *P. ovale*, *P. malariae* and *P. knowlesi*.

Content

Automated Screening and Cells Counting System for Leukaemia and Malaria with mobile phone notification is developed as an assisting and alternative tool for manual counting procedure. The operation of this system is to automatically screen and detect the presence of leukaemia cell, and to obtain parasite density from malaria blood samples. This system consists of image processing facilities to perform the WBCs and parasites counting, as well as integration with mobile phone to inform the person in charge of the patients. Furthermore, this system consists of several applicability and advantages. Firstly, the current procedure based on manual counting of the cells is time consuming and vulnerable to human error. Therefore, the counting process is done by software and the results of leukaemia screening and parasites counts can be provided to user with mobile notification in less than 2 minutes. Secondly, most blood analyzers software's are designed for specific type of disease. In contrast, this system provides a tool for detection of two main diseases which are leukaemia and malaria. With this system, automated cells counting is more practical compare to the manual process as it is fully assessed by software with less time consumption and percentage accuracy of up to 97%. This system can become a useful tool for medical field as it is expected to help the experts as a part of leukaemia and malaria diagnosis. Thirdly, degraded quality slides and under stained slides are among the issues that may affect the results of counting performance. Hence, this system is provided with image enhancement facilities to improve the image quality for manual inspection purpose. Figure 1 shows the interface of automated screening and cells counting system for leukaemia and malaria. Meanwhile, Table 1 presents the accuracy of the automated screening and cells counting system.

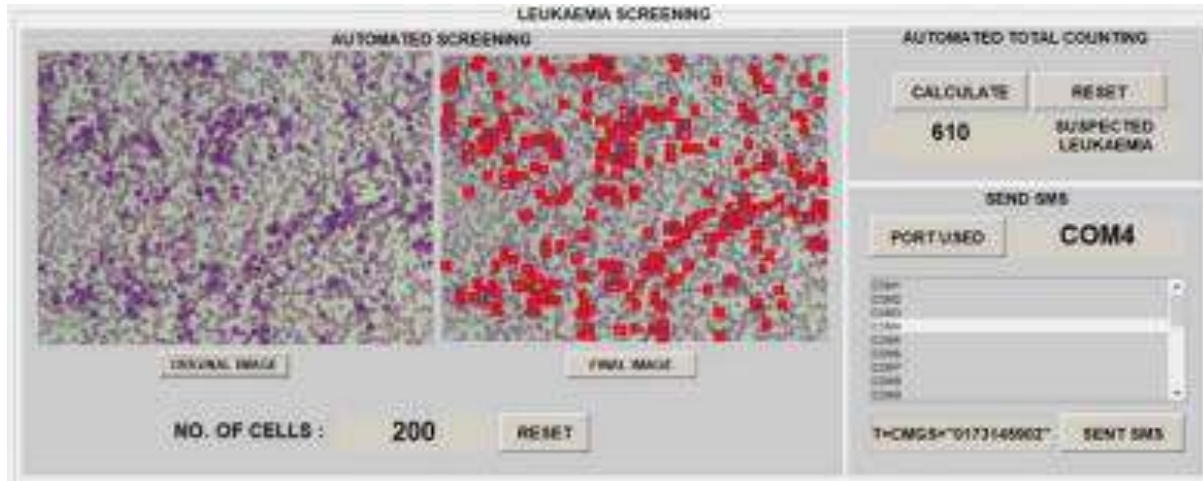

Figure 1: The accuracy of the automated screening and cells counting system for leukaemia and malaria.

Category	Font size
Leukaemia cells counting	Average accuracy is 97.70% for 100 images consisting 7 blood samples (3 normal blood, 2 acute an 2 chronic leukaemia).
Leukaemia slides counting	Accuracy is 100% for 20 blood samples (3 normal blood, 9 acute and 8 chronic leukaemia).
Malaria counting	Average percentage accuracy is 98.51% for 100 images consisting 5 malaria blood samples.

The proposed system also consists of several novel features. For instance, it is the first automated system that has been specially designed to perform screening and counting of leukaemia and malaria cells with high accuracy. This system uses special image processing algorithms which are designed for counting 4 different types of leukaemia cells which are ALL, AML, CLL and CML. In addition, the counting system is also integrated with mobile phone in order to notify the person in charge for the patients result. In terms of marketability for commercial value, this system is efficient and cost effective than manual procedure. Hence, this system is suitable for use in countries with large population but few numbers of haematologists/microbiologists such as India, Indonesian and African regions. Since this system is a type of standalone software, it can be used in any computer without having to install any software.

As a conclusion, Automated Screening and Cells Counting System for Leukaemia and Malaria with mobile phone notification has been developed as an assisting and alternative tool for manual counting procedure. The operation of this system is to automatically screen and detect the presence of leukaemia cell, and to obtain parasite density from malaria blood samples. This system consists of image processing facilities to perform the WBCs and parasites counting, as well as integration with mobile phone to inform the person in charge of the patients. With this system, automated cells counting is more practical compare to the manual process as it is fully assessed by software with less time consumption and percentage accuracy of up to 97%. This system can become a useful tool for medical field as it is expected to help the experts as a part of leukaemia and malaria diagnosis.

Acknowledgement

We are grateful for Universiti Sains Malaysia (USM) for providing the leukaemia and malaria blood samples and validate the results.

References

- Aris, T.A., Nasir, A.A., & Mustafa, W.A. (2018). Analysis of Distance Transforms for Watershed Segmentation on Chronic Leukaemia Images. *Journal of Telecommunication, Electronic and Computer Engineering (JTEC)*, 10(1-16), 51-56.
- Aris, T. A., Nasir, A. S. A., Chin, L. C., Jaafar, H., & Mohamed, Z. (2020, November). Fast k-Means Clustering Algorithm for Malaria Detection in Thick Blood Smear. In *2020 IEEE 10th International Conference on System Engineering and Technology (ICSET)* (pp. 267-272). IEEE.
- Aris, T. A., Nasir, A. S. A., Jaafar, H., Chin, L. C., & Mohamed, Z. (2021). Color Constancy Analysis Approach for Color Standardization on Malaria Thick and Thin Blood Smear Images. In *Proceedings of the 11th National Technical Seminar on Unmanned System Technology 2019* (pp. 785-804). Springer, Singapore.
- Din, A. F., & Nasir, A. S. A. (2021). Automated cells counting for leukaemia and malaria detection based on RGB and HSV colour spaces analysis. In *Proceedings of the 11th National Technical Seminar on Unmanned System Technology 2019* (pp. 981-996). Springer, Singapo

DETECTION AND ASSOCIATED RISK FACTORS ON GASTROINTESTINAL PROTOZOA IN OWNED CATS IN SELECTED DISTRICTS IN KELANTAN

Nurshahirah Shaharulnizim

Faculty of Veterinary Medicine, Universiti Malaysia Kelantan, Pengkalan Chepa 16100 Kota Bharu, Kelantan, Malaysia.
shahirah.s@umk.edu.my

Tan Wan Loong, Intan Noor Aina, Basripuzi Nurul Hayyan

Faculty of Veterinary Medicine, Universiti Malaysia Kelantan, Pengkalan Chepa 16100 Kota Bharu, Kelantan, Malaysia.
loong.d16a0035@siswa.umk.edu.my, intanaina@umk.edu.my, basripuzi@umk.edu.my

Highlights: Gastrointestinal protozoa in cats commonly consist of *Cystoisospora spp.*, *Cryptosporidium spp.*, *Giardia duodenalis*, *Trichostrongylus axei*, *Toxoplasma gondii* and *Entamoeba histolytica*. Study on the prevalence and potential risk factors for gastrointestinal protozoa in Malaysia are lacking. Certain gastrointestinal protozoa such as *Cryptosporidium spp.*, *Giardia duodenalis* and *Toxoplasma gondii* are capable of zoonotic transmission and causes diseases to the cat owners or people who live in proximity with dense cat population, especially immunocompromised individual for example pregnant woman. Thus, a cross-sectional study with the objectives of identifying the prevalence and potential risk factors of gastrointestinal protozoa in owned cats was conducted in Kota Bharu and Bachok, Kelantan, Malaysia. A total of 49 faecal samples was collected and examined in this study. The prevalence of gastrointestinal protozoa in owned cats in selected district in Kelantan is 69.4%. Nine putative risk factors such as age, sex, breed, diet, diarrhoea at the time of sampling, outdoor access, number of cats in a household, living environment (urban or rural), deworming status (deworm at least once a year or never) were being focused in this study. Among all 9 risk factors, only outdoor access was statistically associated with the presence of gastrointestinal protozoa ($p < 0.05$).

Keywords: Gastrointestinal protozoa, Owned cats, Prevalence, Risk factors, Zoonotic

Introduction

Unlike trematode, nematode and cestode, protozoan is a microscopic eukaryotic organism under kingdom Protista, which is single-celled and heterotrophic which utilize organic carbon as a source of energy (Diaz & Laybourn-Parry, 2019). Most of the protozoa on Earth are free living. However, some of the protozoa are parasitic and able to cause diseases in animals and humans. (Hendrix & Mosby, 2016).

Content

In this study, gastrointestinal protozoa that are commonly found in cats such as *Entamoeba histolytica*, *Giardia duodenalis*, *Cryptosporidium spp.*, *Toxoplasma gondii*, *Cystoisospora spp.* and *Trichostrongylus axei* will be focused on (Nguï et al., 2014; Al-talib et al., 2019). Some of the gastrointestinal protozoa like *Giardia duodenalis*, *Cryptosporidium spp.*, *Toxoplasma gondii* and *Entamoeba histolytica* carry the potential zoonotic risk (Holyoake, 2008; Palmer et al., 2008; Wichit R. et al., 2014).

In Malaysia, the most popular companion animal is the cat. According to a report by Euromonitor International, the number of cats and dogs including those owned and stray have increased over the years from 2014 to 2018. Hence, more attention should be placed on the prevalence of cats' gastrointestinal protozoa especially in Kelantan where there is the presence of a higher population of cats, especially in the rural areas. Infected cats with zoonotic protozoa will defecate and live in close proximity to the property of the housing area could be a danger to owners and others especially those that are immunosuppressed such as pregnant woman, children or HIV-patient.

Thus, the importance of this study is to determine the prevalence of gastrointestinal protozoa in cats in Kelantan. The data collected could be useful to the public, veterinarians, or ministry in raising awareness about the zoonotic potential in gastrointestinal protozoa in cats and the importance of hygiene practices, correct anthelmintic and antiprotozoal drug administration to avoid parasitic zoonoses.

A cross-sectional study was conducted to estimate the prevalence of gastrointestinal protozoa in owned cats in Kelantan, Malaysia. At the same time, the potential risk factors associated with the disease was investigated. A total of 49 owned cats from three veterinary clinics which were Klinik Veterinar Universiti Malaysia Kelantan, Klinik Haiwan & Surgeri MHI and Klinik Haiwan Vet O Vet were selected randomly and sampled. Owners' consent was recruited to participate in the study. The information regarding the risk factors was obtained from the cat owners through face-to-face interview or a set of questionnaires.

After obtaining the consent for faecal collection from the cat's owner, information such as the cats' age, sex, breed, diet, management (indoor, semi-indoor or outdoor), number of cats in a household, living environment (urban or rural), deworming status (deworm at least once a year or never) were collected via physical examination, face-to-face interview and/or questionnaires.

Various techniques such as direct wet mount, centrifugal faecal floatation and acid-fast staining were employed to diagnose GI protozoa. To detect motile trichomonads and *Giardia* trophozoites, a direct wet mount was done and examined under a microscope at 400X magnification. For detection of protozoa cysts/oocysts, glass slides prepared by centrifugal flotation technique and acid-fast staining was examined under a microscope thoroughly with a consistent pattern of movement of the microscopic field starting from 40X, 100X and 400X magnification.

The data collected and tabulated in Microsoft Excel 2019 spreadsheet. For data analysis, statistical software IBM SPSS (SPSS for Windows, Version 26.0) was used. Chi-square tests were used to assess variable of the abovementioned risk factors.

This study showed that 34 out of 49 cat faecal samples were found to be positive for at least one protozoa species, accounting for an overall prevalence of 69.4% of gastrointestinal protozoa in owned cats. Five different protozoa species were detected in cat faeces, including *Cystoisospora* spp. (42.9%), *Cryptosporidium* spp. (22.4%), *Giardia duodenalis* (12.2%), *Toxoplasma gondii* (12.2%) and *Entamoeba histolytica* (10.2%). Of all the faecal samples that tested positive for protozoa, 23 (67.6%) of the samples harboured only one species of protozoa while 11 (32.4%) of the samples showed mixed infection of protozoa species

In conclusion, the present study demonstrates a high prevalence of gastrointestinal protozoa infection in owned cats which was 69.4%.

Acknowledgement

We would like to thank veterinary officers in KVUMK, VET O VET and MHI Vet clinics. Not to forget, lab assistants and Faculty of Veterinary Medicine, UMK to make this research possible

References

- Diaz, J. M., & Laybourn-Parry, J. E. M. (2019, February 7). *Protozoan | microorganism*. Encyclopedia Britannica. <https://www.britannica.com/science/protozoan>
- Hendrix, C. M., & Mosby, E. (2016). *Diagnostic Parasitology for Veterinary Technicians* (5th ed.). Elsevier Mosby. <https://www.elsevier.com/books/diagnostic-parasitology-for-veterinary-technicians/hendrix/978-0-323-38982-2>
- Ngui, R., Lee, S., Yap, N., Tan, T., Aidil, R., Chua, K., Aziz, S., Sulaiman, W., Ahmad, A., Mahmud, R., & Lian, Y. (2014). Gastrointestinal parasites in rural dogs and cats in Selangor and Pahang states in Peninsular Malaysia. *Gastrointestinal Parasites in Rural Dogs and Cats in Selangor and Pahang States in Peninsular Malaysia*, 59(4), 737–744. <https://doi.org/10.2478/s11686-014-0306-3>

MASSAGE BAR ADDED WITH WATERMELON SKIN EXTRACT & MINT (Cool-Lit Watermelon Massage Bar)

Siti Nuurul Huda Mohammad Azmin

Faculty of Agro-Based Industry, Universiti Malaysia Kelantan Jeli Campus, 17600 Jeli Kelantan, Malaysia.
huda.ma@umk.edu.my

Nur Dini Dayana Zamzuri

Faculty of Agro-Based Industry, Universiti Malaysia Kelantan Jeli Campus, 17600 Jeli Kelantan, Malaysia.
huda.ma@umk.edu.my

Highlights: The massage bar is lotion-like, but it is in a solid form that has dual functionality. It could be used as a lotion for skin moisturization, while the oily ingredients in the massage bar could be applied for massaging purposes. Agroindustry waste like watermelon rind is precious to incorporate in the massage bar as it composes antioxidant, antifungal, antibacterial, and many more. The use of this watermelon rind in this cosmetic product might reduce the landfill dumping of the waste. Therefore, this research aims to formulate massage bar using a watermelon skin extract incorporated with peppermint essential oil to give the cooling effect. This study tested the DDPH radical scavenging ability, viscosity, pH and hardness of the product and compared the values with the commercial massage bar. The tested properties showed promising results where the developed massage bar in this study can be commercialised.

Key words: *Watermelon rind, Citrullus lanatus, massage bar, peppermint essential oil, cosmetic product.*

Introduction

A massage bar is the product of a dual function where either they can be used as a lotion for skin moisturization or massaging. It is made of various oils, such as coconut oil or argan oil, and an assortment of massage bar extracts contain ingredients that will humidify the skin. The massage bar is applied by only rubbing it onto the skin, and the bar will melt resulting from body heat. Massage bars can be moulded into any shape or feature like bumps, as shown in Figure 1, to provide a massage with more pressure to the skin. To date, there is a lack of study conducted on the production of massage bars using agricultural waste such as watermelon skin.



Figure 1: Massage bar with bumps.

Watermelon is one of the favourite fruits in Malaysia due to its juicy, sweet, and fresh flavour that is famous, especially during hot weather to cool off body heat. However, people only eat the fruit flesh and throw away the skin of a watermelon. This fruit has three major parts, which are flesh, skin/rind and seed. Watermelon contains approximately 68% of the flesh, rind 30 %, and seed 2 % of the total weight. In terms of food waste, the skin of watermelon is at the uppermost percentage in volume, and weight makes it the perfect choice to be the main ingredient in a massage bar. Watermelon skin is one of several restaurants, fruit juice manufacturers, and other production involving watermelon fruit, producing significant solid waste (Bellary et al. 2016). The skin is generally discarded, but it is edible and used as a vegetable occasionally. Therefore, it makes watermelon skin food-grade and dermatologically safe in massage bars as an ingredient. Watermelon skin can be of great value in cosmetics because of phytochemicals and beneficial bioactive compounds. They are carotenoids, polyphenols, vitamins, enzymes, and oils. These lists are treasures for cosmetic benefits, especially products that needed to be applying directly to the humans' skin.

The utilization of fruit skin has gained popularity gradually as they exhibit better biological activity than any other part (Al-Sayed and Ahmed 2013). In fact, the fruit's skin has a rich source of bioactive compounds, with Goulas and Manganaris (2012) said fruits' peel contains higher amounts of phenolic compounds and ascorbic acid than most fruit pulp (Goulas and Manganaris 2012). Thus, incorporating watermelon skin into the massage bar formulation is a great innovation that can be commercialised. It was proven as this project won a grant from Malaysia Social Innovation Accelerator Program (MySIAP) 2021 to commercialise this product. There is also a company who willing to sell this product. Besides, this massage bar product won the diamond award (best of the best) and gold award in the Inspiring Innovation and Discovery, Pharm-IIDEx 2021 organised by University Teknologi MARA. Several intellectual properties have also registered for this product.

Acknowledgement

This study was financially aided by the Ministry of Education Malaysia, Fundamental Research Grant Scheme for Research Acculturation of Early Career Researchers (FRGS-RACER, R/FRGS/A0700/01552A/003/2019/00665) and Universiti Malaysia Kelantan, UMK Prototype Research Grant (UMK-PRO 2020, R/PRO/A0700/01552A/004/2020/00872). These supports are gratefully acknowledged.

References

- Al-Sayed, Hanan M. A. and Abdelrahman R. Ahmed. 2013. "Utilization of Watermelon Rinds and Sharlyn Melon Peels as a Natural Source of Dietary Fiber and Antioxidants in Cake." *Annals of Agricultural Sciences* 58(1):83-95.
- Bellary, Ashwini N., A. R. Indiramma, Maya Prakash, Revathy Baskaran, and Navin K. Rastogi. 2016. "Anthocyanin Infused Watermelon Rind and Its Stability during Storage." *Innovative Food Science & Emerging Technologies* 33:554-62.
- Goulas, Vlasis and George A. Manganaris. 2012. "Exploring the Phytochemical Content and the Antioxidant Potential of Citrus Fruits Grown in Cyprus." *Food Chemistry* 131(1):39-47.

**SMART OPTIMIZATION SYSTEM (SOS):
OPTIMIZATION SYSTEM TRACKER OF BLOOD COLLECTION OPERATION DURING COVID 19**

Ts. Muhamad Hafiz Bin Masran

Institute of Engineering of Mathematics, Faculty of Applied and Human Sciences,
Universiti Malaysia Perlis
hafizmasran@unimap.edu.my

Ts. Dr. Wan nor Munirah Ariffin¹, Dr. Nor Azrita Mohd Amin¹, Nur Arif Azezan¹, YM Prof. Dr. Hjh Raja Suzana Raja Kasim², Muhammad Suhaimi bin Zaini³

¹Faculty of Applied and Human Sciences, Universiti Malaysia Perlis

²Universiti Malaysia Kelantan.

³Pinc Technology Sdn Bhd.

munirah@unimap.edu.my, norazrita@unimap.edu.my, rajasuzana@umk.edu.my, suhaimi150@gmail.com

Highlights: Millions of people require blood for a variety of reasons, including accidents, routine operations, and the treatment of serious illnesses. In many countries, including Malaysia, the supply of blood products is reliant on a small number of willing donors. Nowadays, by looking at trends, blood donation and collection operations in Malaysia have raised concerns about the ability to meet future demands, particularly during the pandemic of Coronavirus disease (COVID-19). Consequently, an innovative simulation system is needed to ensure the suitability of the level of fresh blood in storage while minimizing operation usage. The goal of this project is to design and evaluate a tracking system simulation for the pickup and delivery of blood donations, where at the same time, ensuring the freshness of blood is an asset with selectively minimizing the routes used by blood collecting vehicles to ensure delivery successfully within time constraints. This simulation system also makes sure the total distance traveled and total travel time are minimized by applying a metaheuristics algorithm (Copyright file: DV2020004484) together with Google Maps to find the shortest route. This system will have a great impact and enhance the level of transformation and development of artificial intelligent systems for healthcare in terms of transportation in Malaysia, in line with best practices during the pandemic COVID 19.

Key words: *Blood donation, COVID-19, simulation, vehicle, metaheuristics algorithm, Google Maps, Artificial intelligent, transportation*

Introduction

The world is currently reliant on technology, and everyone from the young to the elderly appears to be heavily committed. Because of the rapid advancement of technology and the pandemic COVID 19, technology now plays a big role in people's daily lives and is a vital part of today's society. Google Maps is a good example of how modern technology may be used as a tracking system. A tracking system is a well-known and dependable technology nowadays. The impact of the COVID 19 epidemic on Malaysia is enormous, particularly in the area of blood donation and collecting. As a result, developing a tracking system for the long-term sustainability of fresh blood in storage is crucial when it comes to the efficiency of blood donation collection under time restrictions and saving lives.

Software Development Methodology

This model is divided into six phases: critical analysis, design, building and prototyping, evaluation, prototype refinement, and final product. The process of developing a system is depicted in Figure 1, which includes all six phases.

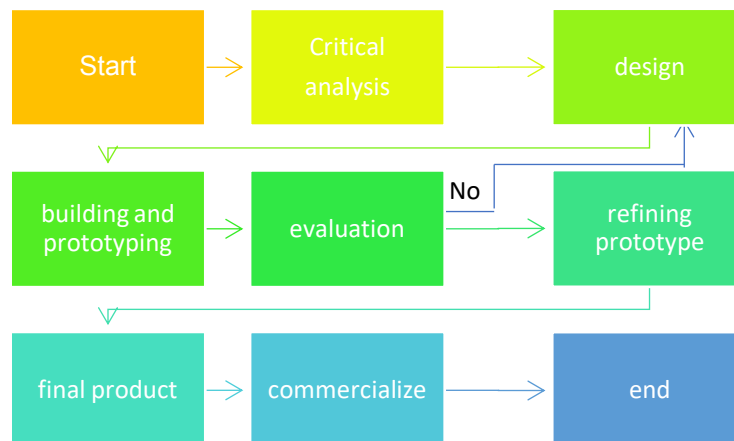

Figure 1: Process of the designing system tracking

The advantages of this innovation and benefits to other industries

Every product, as we all know, has a number of advantages. However, this innovation has several advantages, including reduced cost, user friendliness, minimal operation, the ability to monitor and balance the amount of available fresh blood, and the ability to save lives and time for individuals experiencing blood shortages. Other businesses that deal with perishable goods, such as healthcare, logistics, and retail, can benefit from this development. The budget for each item is shown in Table 1.

Satisfy

Table 1. The Cost Per Tool

Materials	Price	Total Price
CD-ROM	RM 3.00/unit	RM 3.00
Packaging	RM 0.50/unit	RM 0.50
Internet	RM 17/month	RM 17.00
TOTAL		RM 20.50

References

- Azezan, N. A., Ramli, M. F., & Masran, H. (2017). A review on the modelling of collection and distribution of blood donation based on vehicle routing problem, Paper presenter at the AIP Conference Proceedings 1905, 040008 (2017); <https://doi.org/10.1063/1.5012196>
- Azezan, N. A., Masran, H., and Ramli, M. F. "Preliminary design of crow search metaheuristics algorithm for travelling salesman problem," in Proc. 4th Innov. Anal. Conf. Exhib. (IACE), 2019, Art. no. 040004
- Brown, V. (2017, January 10). What You Can Do to Save Lives: Give Us Your Blood!. The Star Retrieved from <https://www.thestar.com.my/news/nation/2017/01/10/what-you-can-do-to-save-lives-give-us-your-blood/>
- Ladle, A., Galpern, P. & Doyle-Baker, P. (2018). Measuring the Use of Green Space with Urban Resource Selection Functions: An Application Using Smartphone GPS Locations. *Landscape and Urban Planning*, 179: 107-115
- Ling, L. M., Hui, T. S., G., T. A. & Ling, G. S. (2018). Determinants of Blood Donation Status in Malaysia: Profiling the Non-Donors, Occasional Donors and Regular Donors. *Kajian Malaysia*, 36(1): 43-62. doi:10.21315/km2018.36.1.3.
- Seong, K. W. (2016). Overcoming Blood Supply Challenges in Multi-Ethnic Donor and Patient Populations: The Malaysia Experience. *ISBT Science Series*, 12(1): 4-10. doi:10.1111/voxs.12329.
- Zakaria, N. F., Abidin, Z., & Zawawi, M. A. Bloodbuddy: a Tracking System for Blood Donor Using GPS. *Journal of Engineering, Technology & Applied Science* 2020, 2(2): 86-102 DOI: 10.36079/lamintang.jetas-0202.117

PARTICLE BOARD MADE FROM WASTE EXPANDED POLYSTYRENE (EPS)

Andi Hermawan

Universiti Malaysia Kelantan, Jeli, Malaysia
 andi@umk.edu.my

**Tuan Mohamad Firdaus bin Tuan Muhamad Adnan, Sharizal bin Ahmad Sobri,
 Nor Hakim bin Abdullah, Mohd Hazim bin Mohamad Amini**

Universiti Malaysia Kelantan, Jeli, Malaysia
 tuanfirdaus07@gmail.com, sharizal.s@umk.edu.my, norhakimin@umk.edu.my, hazim.ma@umk.edu.my

Highlights: This innovation regarding the fabrication of particleboard made from kelepayan wood particles using waste extended polystyrene (EPS) powder as a binder. We successfully developed the fabrication process to meet the Japanese Industrial Standard for Type 8 Particleboard. This particleboard could be used as raw material for furniture manufacturing and other interior design purposes.

Key words: particleboard, waste EPS, recycling.

Introduction

Nowadays, EPS disposal problems are getting considerable attention globally. This is because not only of its high waste management cost but also its negative impact on the environment and human health (Farely and Shaw, 2017). Waste EPS needs higher waste management costs due to its large and bulky, thus require higher transportation costs and occupied significant space in the landfill. It is presently estimated that waste EPS, by volume, takes up as much as 30% of landfills worldwide. In addition, it has been estimated that 14 million tonnes of polystyrene are manufactured worldwide per year, and 80% of styrofoam ends up in landfills, and the rest is in waterways (Chandra et al., 2016). Although waste EPS is non-biodegradable, they do photodegrade into a smaller molecule, making it easier to get into the food chain. This condition could be a potential health hazard for humans, considering that styrene has been classified as a possible human carcinogen.

On the other hand, the wood-based industry has become one of the major revenue contributors to Malaysia's economic growth. Employing approximately 240,000 workers, the industry produces sawn timber, veneer, panel products (plywood, particleboard, chipboard, and fibreboard), mouldings, builder joinery, and carpentry (BJC), as well as furniture and furniture components. Panel products such as particleboard are contributing significantly to Malaysia's export values. In the manufacturing of particleboard, adhesive resin plays a significant role in ensuring the physical and mechanical properties of the board. It was reported that aminoplastic adhesives, such as urea-formaldehyde (UF) and melamine urea-formaldehyde (MUF), are still the most important adhesives for particleboard manufacturing (Kutnar and Burnard, 2014). However, some challenges related to formaldehyde emissions are still highlighted.

The idea of this innovation is that as EPS is a thermoplastic material, it can be reheated, melted, and molded into different kinds of products. These properties could be applied to bond wood particles in particleboard manufacturing.

Content

In the fabrication of particleboard, waste EPS was dried under the sunlight condition, melted, and left to cool at room temperature for solidification. The solid waste EPS was further processed using a grinder to produce waste EPS powder. In addition, kelepayan wood was processed into a woodblock and further processed into wood chips. At the end of the process, the wood chip was processed using a grinder to produce wood particles. The wood particle was dried to reduce the moisture content to below 5%. Based on the oven-dry weight of the wood particles, 40% of waste EPS powder was mixed uniformly with the wood particles and then pressed under 30 tonnes for 600 seconds at a temperature of 180 °C. We successfully fabricated a Type 8 particleboard based on the Japanese Industrial Standard. The fabrication conditions are presented in Table 1.

Table 1. Fabrication conditions.

Target density (g/cm ³)	Waste EPS percentage (%)	Hot-pressing			Dimension (mm)
		Pressure (ton)	Duration (s)	Temperature (°C)	
0.60	40	30	600	180	250×250×10

The background of this innovation is that nowadays, most industries use polystyrene for various functions, including packaging, automobile, electronics, and building materials. As the widespread use of polystyrene increases from year to year, polystyrene disposal problems arise due to its higher waste management cost and negatively impact the environment and human health.

On the other hand, adhesive resin is an essential material in the growth of the timber industry. It improves the quality of wood products, especially in the wood-based composites industry. In manufacturing wood-based panels, wood components are generally mixed with an adhesive resin (Jones and Brischke, 2017). However, not all adhesives resin are safe to use, a drawback such as formaldehyde emissions is harmful to human health; nevertheless, it is still used to manufacture wood-based composites until today (Salthammer et al., 2010).

In this innovation, as an attempt to recycle waste EPS, the waste EPS was used as a binder through reheating and melting in particleboard fabrication. We believe that waste EPS is safer than formaldehyde-based adhesive resin, and thus, it could avoid health issues, and at the same time, could protect the environment from waste EPS pollution. Thus, this innovation is essential to environmental education because we offer a technological alternative to recycle waste EPS for a high-value end product.

This innovation offers a simple process to recycle waste EPS into a high-value end product. We successfully fabricated particleboard using waste EPS powder as a binder. As waste EPS powder was used to replace synthetic adhesive resin, the particleboard fabricated in this innovation may have less production cost, safer for human health, yet has substantial properties to be used as raw material for furniture and other interior design purposes. In addition, we believe that recycling waste EPS into particleboard will reduce pressure on the environment due to EPS pollution which increases from year to year, as Malaysia is one of the particleboard producer countries.

Malaysia listed export of particleboard in 2019 to around 0.8 million m³, equal to RM 367 million. This considerable amount is predicted to increase in the future. Therefore, this innovation has excellent potential to be applied in particleboard manufacturing.

References

- Farely, A.T. & Shaw, C.I. Polystyrene as Hazardous Household Waste. In Household Hazardous Waste Management; IntechOpen: London, UK, 2017; pp. 44–60.
- Chandra, M., Kohn C., Pawlitz J., & Powell G. (2016). Real Cost of Styrofoam. Available online: https://greendiningalliance.org/wp-content/uploads/2016/12/real-cost-of-styrofoam_written-report.pdf (accessed on 10 May 2021).
- Jones D. & Brischke C. (Eds.) 2 -Wood as bio-based building material in Performance of Bio-Based Building Materials. Woodhead Publishing: Cambridge, 2017; pp. 21–96.
- Salthammer T., Mentese S., & Marutzky R. (2010). Formaldehyde in the Indoor Environment. Chemical Review 110, 2536–2572.
- Kutnar, A. & Burnard, M. D. (2014). The past, present and future of EU wood adhesive research and market. In Proc. of the International Conference on Wood Adhesives 2014, 9–11 October 2014, Toronto, Canada, available at: http://www.forestprod.org/ckfinder/userfiles/files/akutnar_08102013.pdf.

HIGH GRADE ALPHA CELLULOSE OF SESBANIA GRANDIFLORA

Liew Jing Xian

Universiti Malaysia Kelantan, Kelantan, Malaysia
ljxian.j19d016f@siswa.umk.edu.my

Boon Jia Geng, Liew Jeng Young, Suganthi Apalasyam

Universiti Malaysia Kelantan, Kelantan, Malaysia
Jia.geng@umk.edu.my, ljyoung@umk.edu.my, suganthi@umk.edu.my

Highlights: *Sesbania grandiflora* is selected as raw material in the production of high-grade alpha cellulose as an innovation product. The determination of high-grade alpha cellulose is carried according to the TAPPI standard with modification. It is an empirical procedure and widely used to evaluate the pulp quality. This research, entitled "High Grade Alpha Cellulose of *Sesbania grandiflora*", is to highlight the potentiality of *Sesbania grandiflora* in producing high-grade alpha cellulose and its industrial utilisation.

Key words: *Alpha cellulose, cellulose, kraft pulp, dissolving pulp, Sesbania grandiflora, TAPPI.*

Introduction

Sesbania grandiflora possesses outstanding characteristics like high cellulose content and short fiber length which is suitable for pulping has made it a popular pulp source (Orwa et al., 2009). Some researchers had reported about the medicinal values of its leaves and flowers (Karmakar et al., 2016). However, there have been limited empirical investigations on the trunk in producing alpha cellulose.

Cellulose mainly found from various plant fibers such as corn stalk, soybean hulls, bagasse, oat hulls, rice hulls, wheat straw, bamboo, and sugar beet pulp (Hanna, 2001; Ang, 2001; Franz 1990). Cellulose is an organic compound that can be found in the cell walls together lignin in cementing the structure of plants. It consists of 3 fractions, alpha, beta and gamma. While, alpha cellulose is often used as a marker of the purity of a cellulose material in its application because it contains the highest purity level (Rivai et al., 2018).

This present study is attempted to examine the potentiality of *Sesbania grandiflora* in producing high-grade alpha cellulose. It is a novelty point because this plant species is considered new to research field.

Content

The alpha cellulose product development is obtained through the chemical kraft pulping of *Sesbania grandiflora* chips by cooking in the mixture of sodium hydroxide and sodium sulphite for a definite time, followed by chlorination method to extract the cellulose component. Then, alpha cellulose is extracted consecutively with 17.5% sodium hydroxide solution under definite conditions for a definite time according to the modified TAPPI standard (TAPPI, 1999). The percentage of insoluble alpha cellulose content is calculated according to the formula.

Sesbania grandiflora is locally known as turi. The attractive backgrounds are it is a fast-growing and straight tree that can reach 20 feet in height. It has a short cop rotation of 3 to 4 years and contain higher cellulose raw material per unit area than most other pulp woods (Orwa et al., 2009). Between, the alpha cellulose produced from *Sesbania grandiflora* is considered high (87%) among the other pulpwood. It has a great potential to be a pulp source in Malaysia to overcome the high demand for domestic wood supplies (Pratima, 2018).

The industrial application of *Sesbania grandiflora* wood as raw material is underexplored. Thus, more research can be carried to explore the possibilities and utilisations of *Sesbania grandiflora* in the industrial applications. Between, reveal the potential of a new pulpwood can be considered as a great effort to enhance the sustainable development in wood-based industries and avoid big scale of deforestation activities.

The main advantage of this product is the high purity level (up to 87%) which contains very low amounts of impurities, non-toxic in nature, and almost no ash is left after combustion. Between, *Sesbania* pulp is abundantly available in Malaysia, low weight, biodegradable, renewable, and very economical to be harvested (Kalia et al., 2011).

While, the commercial values of high-grade alpha cellulose from *Sesbania* pulp in terms of marketability or profitability are great deal in various industries. For instances, the development of dissolving pulp in producing high-grade paper product (Chen et al., 2016; Heinze & Liebert, 2012); as raw material for rocket propellant manufacture (Jm, 2017); as derivatives such as cellulose gums, including sodium carboxymethylcellulose (CMC) in construction industry for making cement and building material, in making soaps and detergents, in plastic industry and in medicine industry for forming gel to use in heart, thoracic and cornea surgery; as a valuable additive of microcrystalline cellulose (MCC) in cosmetics, food and pharmaceutical industries and also cloth industry.



Figure 1. Alpha cellulose of Sesbania pulp

Acknowledgement

We are grateful for the Ministry of Education Malaysia under Fundamental Research Grant Scheme (FRGS/1/2019/STG07/UMK/02/3).

References

- Ang, J. (2001). International Fiber Corporation, Tonawanda NY. pers. communication.
- Chen, C., Duan, C., Li, J., Liu, Y., Ma, X., Zheng, L., Ni, Y. (2016). Cellulose (Dissolving Pulp) Manufacturing Processes and Properties: A mini-review. *BioResources*, 11 (2), 5553-5564.
- Franz, G., and Blaschek, W. (1990). Cellulose. In *Methods in Plant Biochemistry* (Vol. 2, pp. 291-322): Elsevier
- Hanna, M., Biby, G., & Miladinov, V. (2001). Production of Microcrystalline Cellulose by Reactive Extrusion. In: *Google Patents*.
- Heinze, T., & Liebert, T. (2012). 10.05 - Celluloses and Polyoses/Hemicelluloses. In K. Matyjaszewski & M. Möller (Eds.), *Polymer Science: A Comprehensive Reference* (pp. 83-152). Amsterdam: Elsevier.
- Jm, A. (2017). The Exploration of Alpha Cellulose in Kapok Fruit as Raw Material for Rocket Propellant Production. *Agricultural Research & Technology: Open Access Journal*, 12. doi:10.19080/ARTOAJ.2017.12.555852
- Kalia, S., Dufresne, A., Cherian, B. M., Kaith, B., Avérous, L., Njuguna, J., & Nassiopoulos, E. (2011). Cellulose-based Bio-and Nanocomposites: A Review. *International journal of polymer science*, 2011.
- Karmakar, P., Singh, V., Yadava, R. B., Singh, D. B., Singh, R., & Kushwaha, M. (2016). Agathi [*Sesbania grandiflora* L. (Agast)]: Current Status of Production, Protection and Genetic Improvement.
- Orwa et al. (2009). *Sesbania grandiflora*. Retrieved from http://apps.worldagroforestry.org/treedb/AFTPDFS/Sesbania_grandiflora.PDF.
- Rivai, H., Hamdani, A., Ramdani, R., Lalfari, R., Andayani, R., & Armin, F. (2018). Production and Characterization of Alpha Cellulose Derived From Rice Straw (*Oryza sativa* L.). *International Journal of Pharmaceutical Sciences Review and Research*, 52, 45-48.
- Tappi. (1999). T 203 cm-99. Alpha-, Beta- and Gamma-cellulose in Pulp. *Tappi Standard*.

GREEN POROUS CERAMIC THERMAL INSULATOR (GreenPCTI) MADE FROM WOOD SAW DUST WASTE

Pao Ter Teo

Faculty of Bioengineering and Technology, Universiti Malaysia Kelantan, Jeli Campus, Kelantan, Malaysia
teopaoter@umk.edu.my

**Afiqah Awang Kechik¹, Siti Koriah Zakaria¹, Nur Atikah Muhammad Tharmizi¹, Arlina Ali¹, Jia Geng Boon¹,
Mardawani Mohamad¹, Mohamad Najmi Masri¹, Julie Juliewatty Mohamed¹, Mustaffa Ali Azhar Taib²**

¹Faculty of Bioengineering and Technology, Universiti Malaysia Kelantan, Kelantan, Malaysia

²Division of Advanced Ceramic Materials Technology, Advanced Technology Training Center (ADTEC) Taiping,
Kamunting, Perak, Malaysia

j20d0002f@siswa.umk.edu.my1, koriah.j19d0001f@siswa.umk.edu.my2, atikah.j17b0081@siswa.umk.edu.my2,
arlina@umk.edu.my4, jia.geng@umk.edu.my5, mardawani.m@umk.edu.my6, najmi.m@umk.edu.my7,
juliewatty.m@umk.edu.my8
mustaffa.ali@adtectaiping.edu.my

Highlights: The invented green porous ceramic made from wood saw dust is mainly used as thermal insulator, and highly applicable for furnace insulation as well as insulator in electrical appliances. To the best of our knowledge, none of researches have proposed on utilization of wood saw dust into porous insulator and we are among the pioneers to do so. Wood saw dust could be potentially utilized as pore forming agent due to the dust has fine and uniform particle size distribution, ranging from 1.5 μm to 63 μm . In addition, wood saw dust also has a much lower ignition point of approximately 118 °C to 142 °C. Hence, a much lower of heat (firing temperature) was applied to ignite the dust and eventually forming pores during firing, and subsequently capable to reduce embodied energy as well as carbon footprint for the porous thermal insulator. We have successfully utilized the wood saw dust as pore forming agent in porous ceramic, which possess balanced characteristics between low porosity, high compressive strength and low thermal conductivity (good insulating property).

Key words: *Green porous ceramic; thermal insulator; wood saw dust; pore forming agent*

Introduction and Contents of Invention

Wood saw dust is one of the major waste resulted from wood exploitation and processing such as sawing, milling, planning, routing, drilling and sanding. The saw dust is generated in large quantities by the current growing timber industries, furniture factories and sawmills in developing countries, including Malaysia, which stored in uncontrolled conditions may be an important factor of environmental pollution. Conventionally, the wood dust is widely used in medium density fiberboard (MDF), furniture, solid fuel for heat boiler as well as some eventually go to landfills for disposal. However, those applications and efforts are still insufficient to cater the huge amount of saw dust generated every year. Therefore, this invention proposes to utilize the wood saw dust into new product, namely green and environmentally friendly porous ceramic for thermal insulating application.

Porous ceramic is usually understood as material with porosity over 15% and up to 50%. Today, porous ceramics are a class of highly reticulated ceramic materials such as clay-based, carbide and nitride compounds, that covers a wide range of structures, such as foams, honeycombs, interconnected rods, fibers, or hollow spheres. Porous ceramics are featured in their unique combination of valuable properties such as porosity, water absorption and modulus of rupture (MOR), contributing to its usefulness in a variety of conventional and advanced engineering applications. Generally, porous ceramics could be used as filtration materials to filtrate harmful bacteria belonging to the microorganism. Once the level of controlling the fine pores of porous ceramics was increased, the resulting products gradually become more significant and valuable, expanding the usage of porous ceramics in separation, dispersion, and adsorption technologies. Presently, porous ceramics are widely used in many industrial areas, including the chemical engineering, metal smelting, petroleum, textile, pharmaceutical, and foodstuff machinery industries. Also, these porous ceramics have been used increasingly in sound-absorbing materials, sensitive components, artificial bones, tooth root materials as well as thermal insulator for thermal insulating application.

A thermal insulator is a poor conductor of heat and has a low thermal conductivity, suitable for thermal insulating application. Insulation is used in buildings and in manufacturing processes to prevent heat loss or heat gain. It is reported that pores in the insulator act as empty spaces or voids (though may contain air) to insulate the thermal flow hence, the reduction in thermal conductivity of the insulator. The development of porous ceramic insulator is a crucial issue as it of researchers have reported that most of pore forming agents in insulator are synthetic materials such as oil shale (OS), expandable polystyrene (EPS), carbon, polymer microbeads and tert-butyl alcohol (TBA). However, the synthetic materials are hazardous, toxic and harmful to the environment especially during their decomposition to form the pores in porous ceramic. Therefore, utilization of natural-based pore forming agents especially solid wastes is highly potential to solve the environmentally issues.

To the best of our knowledge, none of researches have proposed on utilization of solid wastes into porous insulator. It is rather challenging to simultaneously control porosity, mechanical properties and thermal conductivity of the insulator due to particle size and morphology of solid wastes are inconsistent. Out of the solid wastes, wood saw dust could be potentially utilized as pore forming agent for the porous ceramic thermal insulator due to the dust has fine and uniform particle size distribution, ranging from 1.5 μm to 63 μm . In addition, wood saw dust also has a much lower ignition point of approximately 118 $^{\circ}\text{C}$ to 142 $^{\circ}\text{C}$. Hence, a much lower of heat (firing temperature) will be applied to ignite the dust and eventually forming pores during firing, and subsequently capable to reduce embodied energy as well as carbon footprint for the porous thermal insulator.

In this invention, we have successfully utilized the wood saw dust as pore forming agent in the green porous ceramic for thermal insulating application, and achieve the balanced properties of low porosity, high compressive strength and low thermal conductivity (good thermal insulating property). The successful of this invention would reduce embodied energy as well as carbon footprint for the porous ceramic due to lower flashing point of wood saw dust and usage of much lower firing temperature. Also, the successful of this invention would also reduce the dependency on hazardous and toxic synthetic chemicals of pore forming agent, ensuring a greener and environmentally friendly (Eco-friendly) production of the porous ceramic for thermal insulating application. Subsequently, this is also well-aligned with Malaysia government current "Environment and Climate Change" focus which is part of "Dasar Teknologi Hijau Kebangsaan" policy. In our case, this policy encourages the scientist and industry to practice environmentally friendly and greener processing route in manufacturing industry without deteriorating performance and properties of the porous ceramic.

Acknowledgement

The authors would like to express their gratitude to the Universiti Malaysia Kelantan, UMK Prototaip (UMK-PRO) Research Grant (Grant No: R/PRO/A1300/01687A/002/2020/00871) for the funding of this project.

References

- Adhalina, N. (2011). The Different Language Style and Language Function Between Students and Teachers in Updating Their Status In Facebook Webpage (A Case Study of the Topic National Final Examination 2011)(Doctoral dissertation, University of Diponegoro).
- Alessandra, A. J., O'Connor, M. J., & Van Dyke, J. (1994). People Smarts: Bending the Golden Rule to Give Others what They Want. Pfeiffer.

KELANTAN BAMBOO ACTIVATED CARBON: AN ECONOMICAL AND SUSTAINABLE INNOVATION FOR WASTEWATER TREATMENT BY ADSORPTION TECHNIQUE

Danial Shamzari bin Hashim

Faculty of Bioengineering and Technology, University Malaysia Kelantan, Jeli Campus, Malaysia
danialshamzari@gmail.com

Liew Jeng Young¹, Boon Jia Geng², Ng Kooi Huat³, Sim Kheng Yuen⁴

¹Faculty of Agro-Based Industry, University Malaysia Kelantan, Jeli Campus, Malaysia

²Faculty of Bioengineering and Technology, University Malaysia Kelantan, Jeli Campus, Malaysia

³Faculty of Engineering and Science, Universiti Tunku Abdul Rahman, Jalan Sungai Long, Bandar Sungai Long, Cheras 43000 Kajang, Selangor, Malaysia, ⁴Faculty of Science, Universiti Tunku Abdul Rahman, Kampar Campus, Jalan Universiti, Bandar Barat, 31900 Kampar, Perak, Malaysia

ljyoung@umk.edu.my, jia.geng@umk.edu.my, khng@utar.edu.my, simky@utar.edu.my

Highlights: Wastewater, which causes negative upshots for the environment, is today's global concern. This research showcases the potential application of Kelantan bamboo activated carbon (KBAC), a low-cost and novel bio-adsorbent for wastewater treatment by the adsorption technique. AC is often made from wood; however, bamboo is an alternative to wood with excellent capacity as adsorbent due to its rich carbon content. The KBAC is produced through carbonization and pyrolysis and has received substantial attention from local industries. A letter of intent is in development to initiate a university-industry collaboration to consolidate the invention of KBAC from pilot-scale to a larger-scale systems.

Key words: bamboo, activated carbon, pyrolysis, carbonization, bio-adsorbent, wastewater treatment

Introduction

Wastewater engendering elevates immeasurably with the betterment of living mode, where a colossal share of waste is inaugurated by manufacturing and chemical processes (Kocasoy & Sahin, 2007). Alleviating the menace of wastewater effluent that endangers life is essential. There are multiple techniques recognized for wastewater treatment. Among all other existing treatment of wastewater technologies, adsorption is tagged as a sustainable, cost-effective, and eco-friendly technique. The adsorption technique can eradicate organic pollutants with 99.9% efficacy (Ali, et al. 2012). In this perspective, the activated carbon (AC) is the most often used adsorbent since it owns the suitable porous inner surfaces for gas or liquid access. Sheng et al. (2012) reported that bamboo is feasibly used in heavy metal separation and wastewater purification. Due to the massive carbon content in bamboo, the bamboo AC has emerged as an escalating adsorbent to eliminate pollutants, heavy metal or dye removal (Norhusna et al., 2013). Notwithstanding the rapid growth rate of bamboo in Malaysia, scarce research has been done in converting bamboo into AC. The AC used in Malaysia is often made from wood materials. Inspired by the favourable properties in bamboo, this research was launched to produce the Kelantan bamboo AC (KBAC), an economical and novel bio-adsorbent for wastewater treatment by the adsorption technique. The KBAC offers a local, sustainable technology to Malaysia in battling the wastewater problem while leveraging the domestic bamboo commodity industry.

Content

Bamboo, a non-wood plant, is introduced as a good bio-adsorbent with high capability in adsorbing foreign materials in water (Ademiluyi & David, 2012). In today's market, AC is a type of bio-adsorbent typically made from wood products. Imported wood-based AC products in Malaysia are relatively high-priced. The novelty of this innovation lies in its initiative to develop a wastewater treatment technique with local, sustainable technology.

Specifically, this research converted a non-wood product, i.e., the Kelantan bamboo, into a bio-adsorbent named KBAC. The easy availability of Kelantan bamboo, credited to its high growth rate, has significantly put the amount of time it takes in creating the AC raw materials to minimal. The bamboo can be harvested quicker over the wood as the former matures in 3-5 years while the latter takes over 5 years to reach maturity before harvesting (Itoh & Shimanji, 1981).

The harvested Kelantan bamboo was 24 hours air and oven-dried respectively, which aim to reduce the moisture content below 15%. The dried bamboo was sliced, chipped, and blended into a fine powder. Four hours of carbonization and pyrolysis at 550°C through the steaming method took place to turn the powder into a readily used bio-adsorbent for wastewater treatment. Indisputably, the production process of KBAC is uncomplicated, and it has kept the production cost minimum.

The KBAC is an advantageous consumable domestic product. Besides eco-friendly, the KBAC exhibits excellent surface area characteristics and porosity properties. These superior traits granted the KBAC a high strength in adsorbing the foreign particles in the water. In practice, KBAC and wood-based AC products have virtually coincident performances for absorption capability, but the KBAC is shown to prevail from a cost perspective.

This innovative product has recently been shared with the public, where its findings will be published as a Scopus indexed article in the AIP proceeding. The KBAC's versatile merits have drawn considerable attention from the local community and industries, especially the SMEs. A university-industry collaboration certainly makes the KBAC remained a competitive advantage in the market share. Developing a letter of intent between UMK and the industry would be a step in the right direction.

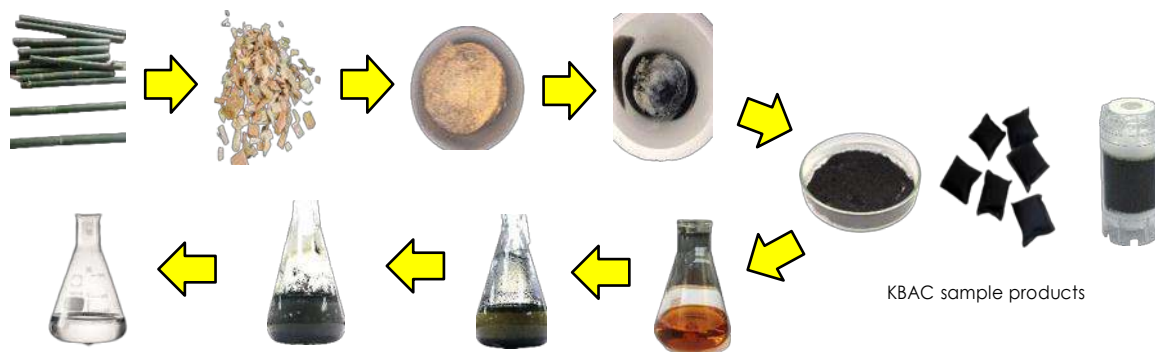

Figure 1. The production and implementation of KBAC for wastewater treatment

Acknowledgement

This research was supported by grant from the Malaysia Fundamental Research Grant Scheme (FRGS) (Grant No.: R/FRGS/A0700/01450A/001/2018/00560).

References

- Ademiluyi, F. T. & David-West, E. O. (2012). Effect of chemical activation on the adsorption of heavy metals using activated carbons from waste materials. *International Scholarly Research Notices*, 2012, 1-5.
- Ali, I., Asim, M., & Khan, T. A. (2012). Low cost adsorbents for the removal of organic pollutants from wastewater. *Journal of Environment Management*, 113, 170-183.
- Itoh, T. & Shimanji, K. (1981). Lignification of bamboo culm (*Phyllostachys pubescens*) during its growth and maturation. *Bamboo production and Utilization Proc. XVII IUFRO Congress Group 5.3*. Ed T. Higuchi Kyoto Japan, 10, 101-104.
- Kocasoy, G. & Sahin, V. (2007). Heavy Metal Removal from industrial Wastewater by Clinoptilolite. *Journal Environment Science and Health Part A*, 42, 2139-2146.
- Norhusna, M. N., Lau, L. C., Lee, K. T. & Abdul, R. M. (2013). Synthesis of activated carbon from lignocellulosic biomass and its application in air pollution control. *Journal of Environment Chemical Engineering*, 1, 658-666.
- Sheng, F. L., Song, Y. W., Ming, J. T. & Lang, D. L. (2012). Adsorption capacity and removal efficiency of heavy metal ions by moso and ma bamboo activated carbons. *Chemical Engineering Research and Design*, 90, 1397-1406.

WASTE TO WEALTH; A NOVEL BIODEGRADABLE COMPOSITES FROM AGRICULTURE WASTE FOR DRUG DELIVERY

Nor Hakimin Abdullah

Advanced Materials Research Cluster, Faculty of Bioengineering and Technology, Universiti Malaysia Kelantan Jeli Campus, Kelantan, Malaysia
norhakimin@umk.edu.my

Nur Aiman Mohamad Senusi, Rathesh Kumaran A/L Ulaganathan, Mohammad Aiman Hakim Bin Abdullah

Advanced Materials Research Cluster, Faculty of Bioengineering and Technology, Universiti Malaysia Kelantan Jeli Campus, Kelantan, Malaysia
nuraimansenusi96@gmail.com, ratheshkumaran22@yahoo.com

Highlights: In recent years, particular attention has been given to the development of biodegradable polymers from renewable resources to maintain sustainable development of the economy towards a greener environment. In this research, cellulose was extracted from the oil palm trunk using the hydrothermal method. The extracted cellulose then was mixed with carboxymethyl cellulose (CMC) to form a thin film. Next, the thin film was dried and cut into small pieces as bioresin. The bioresin then was put in a mould to form the biodegradable capsules that could be used for oral drug delivery.

Key words: *oil palm trunk, hydrothermal treatment, carboxymethyl cellulose, biodegradable capsule, drug delivery*

Introduction

Plastic industries have grown for many years. People use plastic in every aspect of everyday life. The problem with this product is its lifespan. Regular polyethylene plastic or PE can take up to 450 years to degrade (Chamas et al., 2020). In recent years, particular attention has been given to developing biodegradable polymers from renewable resources, especially for packaging and disposable applications, to maintain sustainable development of economically and ecologically attractive technology towards a greener environment. Among these biopolymers, starch is a cheap biopolymer biodegradable, ultimately up to carbon dioxide and water.

In Malaysia, a large plantation of oil palm has been planted. In Malaysia, it has been estimated that the falling of oil palm yields about 7 metric tons of stem per hectare (Barcelos et al., 2015). There are several ways to dispose of oil palm stems. Typically, the oil palm trunks are left to rot or burnt in the field. However, due to high moisture content, the oil palm trunk is not easily burnt. Besides, the practice of disposing of oil palm by burning is now considered unacceptable because it contributes to air pollution and affects the environment. Leaving the stems in the field to rot will contribute to another problem, such as hindering planting new crops. It is known that palm oil trees can only produce oil for up to 25 years. After that, the trunk will be chopped and degraded at the plantation. Typically, the oil palm trunks are left to rot or are burnt in the field (Flood et al., 2002). Hence, by using the hydrothermal method, cellulose can be extracted from the core of the oil palm trunk to develop organic biodegradable plastic further.

In this research, cellulose was extracted from the oil palm trunk using the hydrothermal method. The extracted cellulose then was mixed with carboxymethyl cellulose (CMC) to form a thin film. Next, the thin film was dried and cut into small pieces as bio-resin. The bio-resin then was put in a mould to form the biodegradable capsules that could be used for oral drug delivery.

Content

1. Description of my innovation / product development / design / process.

In this research, cellulose was extracted from the oil palm trunk using the hydrothermal method. The extracted cellulose then was mixed with carboxymethyl cellulose (CMC) to form a thin film. Next, the thin film was dried and cut into small pieces as bio-resin. The bio-resin then was put in a mould to form the biodegradable capsules that could be used for oral drug delivery.



Figure 1. The overview of bio-resin preparation

2. What is the context or background of my innovation / product development / design / process?

This innovation implementing the waste to wealth concept where we use the agriculture waste to create a new product from agriculture. Biodegradable composites are a sustainable alternative for oral drug delivery where the delivery system should carry drugs and antigens in stable forms and protect these biomolecules from degradation in the harsh environment of the stomach and intestinal lumen. In this regard, natural biodegradable polymer-based particulate systems have emerged as a good and safe choice for oral drug delivery.

3. Why are they important to education?

This project involves postgraduate students (MSc) under FRGS, MOHE grant. Through this project, students are given exposure related to the application of material technology to create a new useful product from agricultural waste and provide the students with enough knowledge on natural polymer utilization in the medical industry.

2. Advantages of my innovation / product development / design / process towards education and community.

Implementation Waste to Wealth concept to create a new sound product from agricultural waste

- In line with Sustainable Development Goals 12 (Responsible consumption and production) and 13 (Climate action) that could reduce the environmental impact of waste
- A novel biodegradable plant-based composites that could be used as a capsule for drug delivery

3. Commercial value in terms of marketability or profitability of innovation /product development /design /process

Patent Application No: PI 2018702814 has been filed for this product with the title "Biocomposite Film Composition". There are 2 Scopus Indexed publications related to this product, namely (i) Preparation and Characterization of Kenaf and Oil Palm Nanocellulose by Acid Hydrolysis Method. Materials Science Forum, 1010, 495-500, and (ii) Preparation & Characterization of Microcrystalline Cellulose from Agriculture Waste. IOP Conf. Ser.: Earth Environ. Sci. 596 012035 This product is also in collaboration with the company – GTE Enov (MOA) entitled "EXTRACTION OF NANOCELLULOSE FROM AGRICULTURAL WASTE DEVELOPMENT OF ORGANIC BIODEGRADABLE PLASTICS" - R/SGJP/A1300/00462A/002/2019/00615

Acknowledgement

We are grateful for the awarded grant to Ts. Dr. Nor Hakim bin Abdullah namely FRGS (R/FRGS/A1300/00462A/003/2019/00713) and Skim Geran Penyelidikan Padanan Universiti (SGPPU) (R/SGJP/A1300/00462A/002/2019/00615).

References

- Chamas, A. Moon, H. M., Zheng, J., Qiu, Y., Tabassum, T., Jang, J. H., Abu-Omar, M., Scott, S. L., Suh, S. (2020) Degradation Rates of Plastics in the Environment. ACS Sustainable Chem. Eng. 2020, 8, 9, 3494–3511
- Barcelos, E., Rios, S., Cunha, R. N., Lopes, R., Motoike, S. Y., Babiychuk, E., Skiryicz, A., & Kushnir, S. (2015). Oil palm natural diversity and the potential for yield improvement. *Frontiers in plant science*, 6, 190. <https://doi.org/10.3389/fpls.2015.00190>
- Flood, J., Keenan, L., and Wayne, S. (2005) Studies on oil palm trunks as sources of infection in the field. *Mycopathologia* 159, 101–107

REDUCING CORROSION ON STAINLESS STEEL PIPELINE VIA HYDROGEN INDUCE CRACKING

Associate Professor Dr. Mohamad Najmi Masri

Universiti Malaysia Kelantan
najmi.m@umk.edu.my

Nur Adeeba Zakiah Che Yusoh Zaki

Universiti Malaysia Kelantan
adeeba.j18a0232@siswa.umk.edu.my

Highlights: The method of extracting oil and natural gas supplies continues to accelerate in order to satisfy global demand. Pipelines classified as gathering, transmission, distribution, or flow lines depending on their properties and applications in petrochemical industry. ASTM A304 steel used to convey oil and natural gas from processing field to export loading facility. These materials affected by hydrogen induced cracking (HIC) when hydrogen that existence in crude oil or natural gas diffuses into microstructure of stainless steel to reaches critical amount and cracks initiate (Eskandari, 2017).

Key words: *extracting oil, natural gas, global demand*

Introduction

The method of extracting oil and natural gas supplies continues to accelerate in order to satisfy global demand. Pipelines classified as gathering, transmission, distribution, or flow lines depending on their properties and applications in petrochemical industry. ASTM A304 steel used to convey oil and natural gas from processing field to export loading facility. These materials affected by hydrogen induced cracking (HIC) when hydrogen that existence in crude oil or natural gas diffuses into microstructure of stainless steel to reaches critical amount and cracks initiate (Eskandari, 2017). Research on electrochemical hydrogen-charging and discharging of mechanical properties A304 steel been studied to observe microstructure crack morphology, centre segregation and harness of sample after electrochemical hydrogen charging setup (Mohtadi-Bonab et al., 2016). This study able to reduce corrosion process in petrochemical industry in order to improve development and production of petrochemical product.

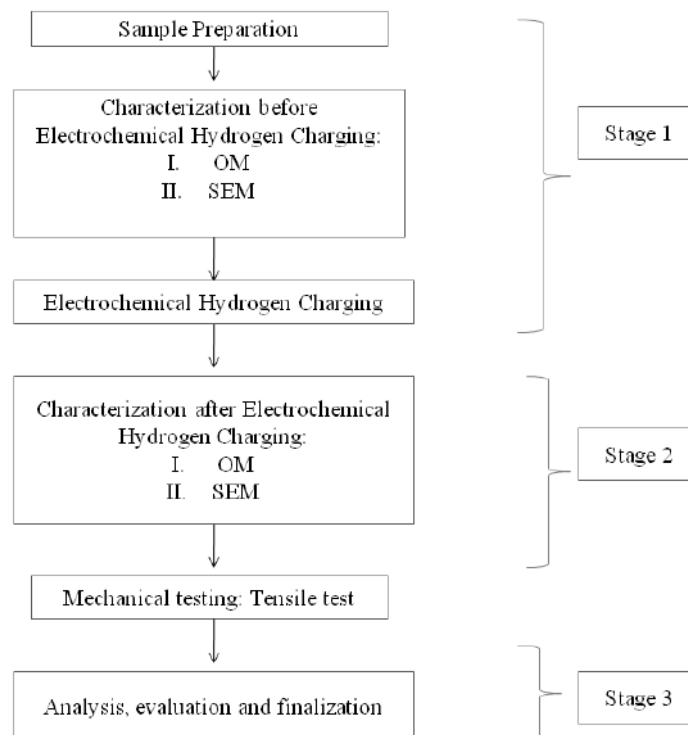

Figure 1: The research flow experiment set up of electrochemical hydrogen charging.

Acknowledgement

I would like to precise my perpetual appreciation to UMK JELI for helping and guiding me with lab works and characterization machines to improve my information and practical aptitudes particularly in investigate area. My appreciation too been expanded to UMK's lab assistants for guiding me with the tests conducted through this project.

References

- Eskandari, M. (2017). PT SC. Engineering Failure Analysis. <https://doi.org/10.1016/j.engfailanal.2017.05.022>
- Mohtadi-Bonab, M. A., Eskandari, M., Rahman, K. M. M., Ouellet, R., & Szpunar, J. A. (2016). An extensive study of hydrogen-induced cracking susceptibility in an API X60 sour service pipeline steel. *International Journal of Hydrogen Energy*, 41 (7), 4185–4197. <https://doi.org/10.1016/j.ijhydene.2016.01.031>

THE IMPROVEMENT OF MAMBONG CLAY PROPERTIES WITH CALCIUM CARBONATE ADDITION

Nurul Ainon Bakar

Universiti Malaysia Kelantan, Kampus Jeli, 17600 Jeli, Kelantan, Malaysia
nurulainonbakar28@gmail.com

**Siti Mariam Mat Nor¹, Noruzzaman Daud¹, Wan Nor Dini Wan Azli Jasmi¹, Muhammad Qusyairi Saari¹,
Julie Juliewatty Mohamed¹, Hasanah Safein@Shafie²**

¹Universiti Malaysia Kelantan, Kampus Jeli, 17600 Jeli, Kelantan, Malaysia

²Politeknik Kota Bharu, KM24, Kok Lanas, 16450 Ketereh, Kelantan, Malaysia

mariam_matnor@yahoo.com, zamandaud@gmail.com, wandini.nor@gmail.com, qusyariemus@gmail.com,
juliewatty.m@umk.edu.my, hasanah@pkb.edu.my

Highlights: Mambong pottery is a traditional heritage of Kelantan, Malaysia that existed since 300 years ago. The traditional fabrication includes hand-building and upgraded to slip casting technique. However, the innovation of materials used in the fabrication influence the quality of physical and mechanical properties to increase buyer's interest in order to conserve the heritage. Thus, this research brought a solution which aims the effect of various calcium carbonate (CaCO_3) amount (0, 5, 10 and 15 wt%) as an additive on the properties of Mambong clay.

Key words: Mambong clay, pottery, properties, calcium carbonate, additive

Introduction

Pottery in Kelantan is known as Mambong pottery was existed since hundreds years ago. This pottery was made of Mambong clay that was collected at Kampong Bahagia, near to Kampong Mambong, on the banks of the Galas River, Kuala Krai, Kelantan, Malaysia. Mambong pottery is strong and withstand high temperature, thus it suitable to use as cooking wares [1]. The fabrication technique has been upgraded to produce in larger amount with shorter period such as slip casting.

Slip casting method is one of the molding method that opens a big opportunity for this industry to become wider in the market. Most of the pottery manufacturer in large production preferred to use this technique as it easier to manage and speed up the drying process [2]. The suspension of ceramic powders or clay in water is known as a slip. It is a mix of a fine ceramic powder in water, along with some chemicals that help the powder to disperse throughout the liquid. The slip was poured into a porous POP mold to absorb the water from the mix to form a firm layer of clay.

Other than that, the use of additives in the clay products give various effects to the clay body especially in term of its properties. There were several types of additive used in the clays or ceramics mixture in order to improve or upgrade the properties of the clays and ceramics including calcium carbonate (CaCO_3). One of the special properties of CaCO_3 is as one of the pore forming agent [3] [4]. Dewi et al. (2018) were used three different pore agents including CaCO_3 in their research to produce porous alumina ceramics. CaCO_3 was proved in producing membrane permeability with $0.43.10^{-2} \text{ ml/cm}^2 \cdot \text{s} \cdot \text{bar}$ to prevent clay vitrification in ceramic production [5].

Moreover, previous study by Buchan and Smith (1999) stated CaCO_3 have a remarkable effect after addition to fine soils [6]. This statement supported by a few researchers that the plasticity index is inversely proportional to CaCO_3 content [7] [8]. Thus, the CaCO_3 addition to clay will change the plasticity property. During the manufacturing process, it will affect the technical specifications of the ceramic product. This research was aimed to investigate the influence of CaCO_3 as an additive on the properties of Mambong clay. The various CaCO_3 content amounts (0, 5, 10 and 15 wt%) were used to study the difference between these additions on the clay properties. The temperature was fixed at 900°C with 8 hours firing duration by using slip casting method. However, this pottery nearly to be forgotten by Malaysians even the Kelantanese. There is a lot of people who do not know about the existence of this pottery. Thus, this research also can helps the locals to introduce the world about this pottery in order to conserve the heritage of Kelantan.

Methodology

Mold Preparation

The clay sample was fabricate and shaped by using slip casting method. The mold was set by the Plaster of Paris (POP) mixture. The POP powder were mixed with water by using the ratio of 2:1. The powder was mixed into water to form a slurry, then poured into the model template and left to set.

Clay Preparation

The raw Mambong clay was dried under the sunlight and grounded using a blender to form the clay powder. Then, the powder was sieved by using screening sieving below $425 \mu\text{m}$ to get a fine powder. By using slip casting method, the ratio of clay mixing is 55% of clay and CaCO_3 mixture; and 45% of water to form a slurry paste. The amount of clay was reduced as the percentage of CaCO_3 increased (0, 5, 10 and 15 wt%).

Slip Casting Process

After the complete mixing process, the slurry clay mixture was poured into the slip casting mold and left to set. Then, the clay green body was removed from the mold for drying process for 24 hours in room temperature.

Firing Process

The firing process must start with the fully drying process of samples in the oven with 60-80 °C for 24 hours to avoid thermal shock. The dried clay samples were placed in the furnace with 8 hours soaking time at the temperature of 900 °C. The heating rate was 5 °C per minute.

Testing and Analysis

The samples were tested and analyzed with various testing methods such as density, porosity, shrinkage, flexural strength, and impact strength.

Properties Improvement

Table 1: Properties of improved Mambong clay

Samples Properties	0 wt%	5 wt%	10 wt%	15 wt%
Shrinkage (%)	0.90	0.87	0.74	0.64
Bulk density (g/cm ³)	1.67	1.61	1.57	1.52
Apparent porosity (%)	17.39	19.17	27.93	29.26
MOR (N/mm ²)	3942.952	7249.933	9663.613	4763.432
Bending strength (N/mm ²)	4.208	5.001	8.576	4.934
Impact strength (kJ/m ²)	29.543	49.058	59.183	52.220
Toughness (kJ/m ³)	1477.125	2452.875	2959.125	2611.000

Importance to Education

This research is quite importance to education for students and for the community too. This can helps materials technology's students to understand more about ceramics properties and give them ideas to create deeper research about clay. Other than that, the design and craft's students may able to express their creativity through Mambong pottery manufacturing classes and tutorials. This can helps the villagers learn more about creativities and trends with these students, thus they can fulfil the markets' demand.

Advantages to Community

Today, there are only two manufacturers of Mambong pottery left in Kampung Mambong. When there are no continuous legacy of this heritage, then the production of this pottery will stop, and even to be forgotten by the world. Earlier, all the villagers manufactured this pottery at their own house. But, due to lower demand day by day, they stopped making this pottery and started rubber plantation. This research will help the villagers to continue their product making and help them earning extra income and improve their living standard. The innovation helps them to make larger production per day compared to the previous technique that can produce only two pieces per day. With the helps from NGO's and Kelantan Craft Centre, they can get huge opportunity to create modern and trendy pottery design according to current trend and produce durable product using our technology developed via our previous research since 2017. The larger market will expose them to the bigger market opportunities and increase the product demand.

Commercial and Economical Value

In the Mambong pottery fabrication, the production techniques should aligned with time changes, trends, desires and modernization. The fabrication technique that have been used should produce good quality products. For instance, traditional techniques in ancient times used hand-building method, however, now the technique has been upgraded such as slip casting method as a time saver and produce uniform shape and size.

In addition, improvements of raw materials usage needs to be emphasized as the current technology allows potters to use various additives to enhance product quality especially in terms of product strength. Through the previous studies that have been conducted, they can apply the usage of suitable additives. For example, the usage of CaCO₃ can increase the strength of the pottery.

Others, the art of design should be improve as the desires and current trends. Nowadays, people love the minimal concept such as Scandinavian, and this can be match with the Mambong pottery as the house decoration. Then, the unique patterns and motives could give the high interest for potteries' lovers. The product does not limited to vase or any typical pottery products, but it can be the product with different usage such as candle holder, brooch and key plates and ash tray. By using slip casting method, the potters can express their creativity through the mold template and can use it for so many times! This could increase the production rate in shorter duration.

Furthermore, Mambong pottery is one of the environmentally friendly man-made products where is using natural materials to produce it. Mambong products use Mambong clay that can be found in Kelantan. Typically, the clay resources in Kelantan can be categorized as abundant raw materials. Mambong clay resources can be obtained

near to Kampung Mambong, along the Galas River, in Kuala Krai district, Kelantan. This source of clay is able to support the production of Mambong pottery in sufficient quantities for over several decades to conserve this heritage.

Acknowledgement

The authors would like to thank the funding body R/CRG/A1300/01367A/00/2020/00761 for financial support in this project. Then, the highest appreciation to Advanced Materials Research Cluster, Faculty of Bioengineering and Technology (FBKT), Universiti Malaysia Kelantan (UMK) for the collaboration.

References

- Beringen, F. L., Kolk, H. J. & Windle, D. (1982). Cone Penetration and Laboratory Testing In Marine Calcareous Sediments: Geotechnical Properties, Behavior and Performance of Calcareous Soils. *ASTM STP 777*, 179-209.
- Buchan, S. & Smith, D. T. (1999). Deep-Sea Sediment Compression Curves: Some Controlling Factors, Spurious Over Consolidation, Predictions and Geophysical Reproduction. *Marine Georesources and Geotechnology*, 17, 65-81.
- Dewantara, F. & Budianto, E. (2018). The Impact of Calcium Carbonate As Pore Forming Agent and Drug Entrapment Method Towards Drug Dissolution Mechanism of Amoxicillin Trihydrate Encapsulated by Chitosan-Methyl Cellulose Semi-IPN Hydrogel for Floating Drug Delivery System. American Institute of Physics Inc.
- Dewi, R., Agusnar, H., Alfian, Z. & Tamrin (2018). Effects of Adding Pore Agents to Membrane Permeability by Utilizing Sabang Kaolin as Membrane Support. *AIP Conference Proceedings* 2049, 020007.
- Gani, N. A., Shamsuddin, M. S., Koo, W. K., Masri, M. N. & Sulaiman, M. A. (2015). Chemical Composition of Clays for Pottery in Malaysia. A Review, *Journal of Tropical Resources and Sustainable Science*, 3, 144-153.
- Said, T. S., Ramli, H. & Sedon, M. F. (2011). Local Genius of Mambong Pottery in Kelantan, Malaysia. *International Journal of Humanities and Social Science*, 147-155.
- Simão, L., Caldato, R. F., Innocentini, M. D. M. & Montedo, O. R. K. (2015). Permeability of Porous Ceramic Based on Calcium Carbonate As Pore Generating Agent. *Ceramic international*, 41, 4782-4788.
- Tonnisen, J. Y., Den Haan, E. J., Luger, H. J. & Dobie, M. J. D. (1985). Pier Foundations of the Saudi Arabia-Bahrain Causeway. *Proceedings of the 11th International Conference on Soil Mechanics and Foundation Engineering, San Francisco*, 3, 1575-1578.

K-NUFF BLOCK

Mardawani Mohamad

Faculty of Bioengineering and Technology, Universiti Malaysia Kelantan, Jeli Campus, 17600 Jeli, Kelantan, Malaysia
mardawani.m@umk.edu.my

**Mohamad Najmi Masri¹, Teo Pao Ter¹, Mohd Fadzhel Mohd Nasir², Abdul Hadi Hassan²,
Mohd Ali Amin³, Azkhari Munif³**

¹Faculty of Bioengineering and Technology, Universiti Malaysia Kelantan, Jeli Campus, 17600 Jeli, Kelantan, Malaysia

²Lembaga Kenaf dan Tembakau Negara, Peti Surat 198, 15720 Kota Bharu, Kelantan

³Vertex Central Industries Sdn Bhd, 15050 Kota Bharu, Kelantan

najmi.m@umk.edu.my, teopaoter@umk.edu.my

Highlights: The featured innovation product is K-Nuff Block. The application of kenaf products is quite widespread in the construction, automotive, heat insulator, soundproof sectors. This product is kenaf lightweight reinforcement concrete for the basic material used in any application of concrete products especially in construction industry. This innovation explores the effect of kenaf core and quarry dust as sand replacement in sand cement bricks. High demand and dependency of sand for construction industry led to shortage of resources in the future. Thus, alternative resources are needed as replacement of sand especially for brick production. The requirement for producing lightweight product is essential in construction industry that focus in developing sustainable, green and eco-friendly building materials. This innovative product is a collaboration with the National Kenaf and Tobacco Board (LKTN) and Vertex Central Industries Sdn Bhd.

Key words: *Kenaf, Construction industry, K-Nuff block, lightweight*

Introduction



Content

Kenaf core and quarry dust have potential to be use in construction industries, but utilization of these materials in the production of brick is still unknown. Combination of composition kenaf core and quarry dust replace proportion of sand in brick. Evaluation of the compressive strength and density of K-Nuff Block with different weight percentage of kenaf core and quarry dust. Water absorption and porosity of K-Nuff Block with different weight percentage of kenaf core and quarry dust also being studied.

Acknowledgement

The authors would like to acknowledge Faculty of Bioengineering and Technology, Universiti Malaysia Kelantan, National Board of Kenaf and Tobacco and Vertex Central Industries Sdn Bhd for the collaboration in this innovation project of K-Nuff Block.

References

Alessandra, A. J., O'Connor, M. J., & Van Dyke, J. (1994). *People Smarts: Bending the Golden Rule to Give Others what They Want*. Pfeiffer.

INNOVATION OF HERBAL LIQUID BATH SOAP WITH ALOE VERA EXTRACT AND OLIVE OIL EXTRACT EFFORTS TO BRIGHTEN THE SKIN WITH VISCOSITY METHOD AND CHEMICAL COMPOUND EXPERIMENT

Dika Putra Wijaya

SMAN 4 Pasuruan, Pasuruan, Indonesia
wijayaandhika1@gmail.com

Milan Rosa Aprilia, Daffa Dwi Nafisah

SMAN 4 Pasuruan, Pasuruan, Indonesia
Milanrosa085@gmail.com

Highlights: During the Covid-19 pandemic, we must always maintain productivity in developing ideas that are innovative, effective for utilization, and efficient in their use. Like the manufacture of liquid soap that can brighten human skin in an herbal way with aloe vera extract, and this olive oil extract. Then, we as a team of researchers used quantitative research analysis that directly used viscosity techniques, and chemical formula compounds in this study. Therefore, we as a research team make this innovation to produce our innovative work, and can compete internationally with overseas product competition.

Key words: *Innovation of liquid soap, aloe vera extract, olive oil extract, viscosity method, and research chemical compound method.*

Introduction

During the Covid-19 pandemic, we must always maintain productivity in developing ideas that are innovative, effective for utilization, and efficient in their use. Like the manufacture of liquid soap that can brighten human skin in an herbal way with aloe vera extract, and this olive oil extract. This manufacture is very efficient, because we can look for such plants around their homes or environments while paying attention to the health protocols of Covid-19. Attention to the health protocols of Covid-19. In addition to bath soap, this product has other uses, namely:

1. Can be used as laundry soap
2. Can be used as shampoo
3. Can be used as hand soap
4. Can be used as dish soap

The research method we as a team of researchers used quantitative research analysis that directly used viscosity techniques, and chemical formula compounds in this study. Because this is to create new data, and can be accounted for later. This research we use the school lab, thus streamlining our research towards better, as well as support from outside parties for the taking of subjects to neighbors / people in need.

We as a research team conclude that producing our own soap by using plants and objects around us to make liquid soap is very interesting, it can produce when one day the soap runs out, then we use it with care during the Covid-19 pandemic, and it can bring up an even better innovation to compare the efficacy of natural and artificially made soaps. Every innovation sometimes has a weakness in its benefits, there are side effects, and there is a failure in producing the soap. The results of this study in real time and novelty are also in accordance with the statement of the source, as well as based on the literature studies that support our research.

We as a research team found significant data for our soap innovation, namely using viscosity techniques to produce quality liquid soap, not thin or too thick, and using chemical experimental techniques that require hydrocarbon components in each of these ingredients, we must examine their development, and grateful that we are assisted by several parties, as well as the campus, for our research to invite us to celebrate in finding better results from other innovations.

Therefore, we as a research team would like to thank all those who supported this research, then we strive to continue to develop in monitoring our innovations, both weaknesses and strengths, and being able to produce our own products is already fun for us.

1. To improve the quality of producing liquid soap ourselves, our efforts are always working during the Covid-19 pandemic.
2. To always monitor activities related to our liquid soap innovation, the reviews are quite satisfying.
3. To generate significant data with the viscosity method and the method of hydrocarbon chemistry experiments, so we are sufficient to master in relating our innovations.
4. To be a differentiator from any existing innovations, with different methods, and to come up with sufficient ideas to support our work.

Content

Time and Place of Research

- Research Time: Saturday, April 24, 2021-Monday, April 26, 2021
- At: 09.00-15.00 WIB
- Research Location: Jalan Semangka II, E1. No. 4

Tool and Material

- Olive Oil
- Texapon
- Aloe Vera
- Salt (Natrium Chlorida) NaCl
- Blender
- Camera
- Water
- Basin

How to Make

- Prepare tools and materials
- First, remove the thorns with a knife. After that, peel the outer skin on the aloe vera.
- Next, take part in the aloe leaf / extract. After that, mash the sliced aloe vera using a blender for 5 minutes.
- Then, pour the crushed extract into a small container / bowl.
- After that, add texapon to make the liquid soap.
- Stir until thickened using a plastic spatula, then after thickening is too solid, and until it becomes 1 remove the plastic spatula.
- After that, pour it into a soap container.
- Add salt to neutralize texapon in dissolving.
- Stir until thickened.
- Mix perfume into the solution.
- Stir until well blended.
- After all mixed, be a liquid soap with a mixture of aloe vera and olive oil.

References

- M. Aldofina Ruiz, Jose L Arias, dan Visitacion Gallardo. 2010. Skin Creams Made with Olive Oil. <https://doi.org/10.1016/B978-0-12-374420-3.00124-8>.
- Aline M.M.Bessa, Matheus S.C.Venerando, Filipe X. Feitosa, Lorena M. Alexandre e Silva, Fabiano André, Narciso Fernandes, Rílvia S. de Santiago-Aguiar, Hosiberto B. de Sant'Ana. 2020. Low Viscosity Lactam-based Ionic Liquids with Carboxylate Anions: Synthesis, Characterization, Thermophysical Properties and Mutual Miscibility of ionic liquid with alcohol, water, and hydrocarbons. <https://doi.org/10.1016/j.molliq.2020.113586>. [1 September 2020].

THE CONVERSION OF LDPE PLASTIC WASTE INTO FUEL

Mohammad Shamizi bin Sayuti

Polytechnic of Kota Bharu, Kota Bharu, Kelantan
mohdsyamizi02@gmail.com

Muhammad Afiq Farhan bin Ab Aziz, Affidah Mardziah binti Mukhtar

Polytechnic of Kota Bharu, Kota Bharu, Kelantan
abgkelate57@gmail.com, affidah.mukhtar@gmail.com

Highlights: The conversion of LDPE (Low Density Polyethylene) plastic waste into fuel is using a pyrolysis method. The objective of this study was to identify the length of time and temperature to produce oil, determine the type of oil and test the effectiveness of oil use. The burning of 600g of LDPE plastic waste showed that the time period for the plastic to turn into oil was between 70°C to 120°C within 68 minutes. The study produced petrol oil as new product with temperature range of 74°C, light yellow oil colour, pungent odor, slightly viscous liquid, density value of 0.75kg/l and flammable. The results of the study determining the effectiveness of using oil found, the engine can be started, but the engine noise and a bit shaky, the oil resistance time for 1 liter is ½ hours and the smoke emitted is a lot and blackish white.

Key Words: conversion, LDPE, plastic waste, pyrolysis, density, effectiveness

Introduction

Garbage disposal in our country is becoming more widespread. Through Berita Harian Online published on 16 June 2019 explains that Malaysians produce about 37,890 tons of waste per day with at least 1.17 kilograms (kg) generated for each individual. This is increasing in line with the increase in population and has led to an increase in demand for plastics and plastic products (Alabi et al., 2019).

To overcome the problem, various environmental policies have been undertaken by the government such as the 3R Reduce, Reuse and Recycle campaigns, but these campaigns are still not effective in changing the habits of Malaysians (Abidin, 2010). The recycling rate in Malaysia is only at 5 percent, which is much lower than neighbouring countries (Afroz et al., 2017)

According to (Moh & Manaf, 2014) nowadays most of the waste is dumped in landfills. While Baker (2010) said, disposing of plastics in landfills is not the best measure because chemicals from plastics are capable of poisoning groundwater resources. The burning of plastic is also not allowed because the process can produce toxic substances that are harmful to human health.

Therefore, various studies have been conducted to identify what is the best way to overcome this problem. For example increasing the study of recycling plastic bags to produce oil. This recycling uses a chemical process as a process in which a polymer is chemically converted into a monomer or a depolymerized portion into an oligomer through a chemical reaction. There are five decomposition of polymers into monomers namely hydrogenation, glycolysis, methanolysis, hydrolysis, gasification, pyrolysis and catalytic conversion. Yet the most suitable method is pyrolysis method because the fraction of oil and gas obtained will provide an aliphatic composition with great potential for recycling plastics back to industry.

Pyrolysis process is the process of converting/exchanging plastic waste to be a basic petrochemical that can be used as a raw material hydrocarbons or fuels (Naimah & Aidha, 2017). The process of pyrolysis is called also the process of chemical decomposition of organic material without air. The parameters affect the speed of the pyrolysis reaction has a very strong relationship complex, so that the mathematical model of the pyrolysis reaction speed equation formulated by each researcher always shows an empirical formulation different. If viewed from various angles, the process of pyrolysis has much advantage. In terms of the environment, the pyrolysis process can reduce the volume plastic trash that has been a problem for so long, as well produce alternative fuel sources as a solution to crisis problems energy current (Ulrich & Eppinger, 2001)

Product Development, Design and Process

Chemical recycling is the most complex technology compared to the others. It involves changing the chemical structure of a plastic so that it can be reused as a raw material for different industries or as a basic input for new plastic products. This innovation uses a simple and easy conventional method where, the concept of condensation and evaporation is used to produce oil from combustion. Plastic waste will go through a heating process at the Waste to Chemical (WTC) facility to produce synthesis gas and pyrolysis oil.

The materials needed for this study were, a Waste to Chemical (WTC) facility, 600 grams of LDPE plastic waste, a thermometer and a stopwatch. The process begins by inserting 600 grams of LDPE plastic waste into a plastic incinerator, heating the plastic waste will be done until the production of synthesis gas and pyrolysis oil. Record the time, temperature and volume of oil produced until 600 grams of oil burns out. The process of producing oil from LDPE plastic waste can be referred to figure 1: Waste to Chemical (WTC) Facility.

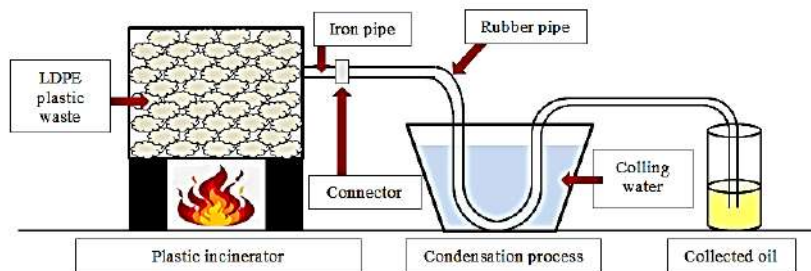

Figure 1: Waste to Chemical (WTC) Facility

Result

To ensure that the concept of oil production through the pyrolysis process can be evaluated, the following table 1 show results of time, temperature and amount of oil obtained for 600g of LDPE plastic waste.

Table 1: Results of time, temperature and amount of oil obtained for 600g of LDPE plastic waste

TYPE OF PLASTIC	WEIGHT (KG)	TIME	TEMPERATURE	VOLUME OF OIL
LDPE Plastic waste	600 gram	75 minute	76°C	53 ml
LDPE Plastic waste	600 gram	60 minute	71 °C	44 ml
LDPE Plastic waste	600 gram	70 minute	74 °C	48 ml
Average		68 minute	74 °C	48 ml

To be sure that the oil produced from the pyrolysis process can be used, the determination of the type of oil required is performed. Oil characteristics such as temperature, colour, odour, viscosity, density and flammability were determined referring to the oil type safety data sheet (Husam Adeni, 2017). From table 2 below, the results show that the oil produced is petrol oil, this is because the colour of the oil is light yellow, the smell is quite strong, the liquid is slightly viscous, its density value is 0.75kg / l and flammable.

Table 2: Results of oil characteristic

OIL CHARACTERISTICS	METHOD OF MEASUREMENT
Temperature Range	The temperature is measured using a thermometer when the oil begins to form = 74 °C
Colour	Compared to the oil colour scale = Light yellow
Smell	Tested with the sense of smell = Stinging smell
Viscosity	By Touch = Slight Viscosity
Density	Calculation of density = $\frac{\text{Mass Weight (m)}}{\text{Volume (v)}} = \frac{40}{53} = 0.75 \text{ kg/l}$
Flammability	Making a flame on oil by using a burner = Flammable

Refers to table 3, although the oil of the study has the same characteristics as gasoline but the difference in its use on the cutting machine shows a poor effect and can give a risk of damage to the motor of the machine. The effect that exists may be due to the oil produced mixing with soot and mixing of water vapour during combustion and condensation of pyrolysis.

Table 3: Oil Consumption Effectiveness Data Produced Through Pyrolysis Process

NUM	ITEM	PETROL OIL	PYROLYSIS OIL FROM LDPE PLASTIC WASTE
1	The engine can be started	Yes	Yes
2	The engine sound	Low noise	Noisy with a bit shaky
3	Time durability	1 litter per hour	1 litter ½ per hour
4	Conditions of smoke	Normal smoke	Smoke emitted is a lot and blackish white.

Discussion

The findings have shown that the characteristics of the oil produced from LDPE plastic waste are similar to the Characteristics of gasoline. This is also supported by a study from Didik Iswadi et.al (2017) who stated that the plastic density value of LDPE of his study is 0.7673 kg/l and is categorized in petrol type. Similarly, Jannat et al., (2019) in a study focusing on pyrolysis method showed that the study density value was 0.763 kg/l. However, Kumar et al.,(2017) through comparison of LDPE plastic processing study report to oil have proved that processed oil consists of gasoline (petrol) component.

This study may seem like a small effort. However, every action to reduce, reuse and recycle contributes to the production of new energy and supports the recovery of other environmental issues that can impact the sustainability of our earth. This is in line with the environmental courses studied at the Polytechnic. Sustainability can be associated with efforts to maintain and preserve originality from social, economic and environmental aspects to ensure the continuity of heritage for the well-being and harmony of present and future generations. Through this study, the problems of acidification, reduction of air, water and soil pollution sources, climate change, ozone depletion, biodiversity reduction, eutrophication, haze formation and habitat change will be saved.

From the physical properties analysis results showed that the oil product's properties were relatively closer to those of kerosene than to those of other commercial fuels. Its mean that this new oil produce from LDPE can be used and commercialized for consumption. However, refining to produce better and more specific fuels is still needed. The purification process that can be done is by distillation or fractionation process.

Acknowledgement

We would like to thank Polytechnic OF Kota Bharu, Kelantan for their assistance and technical management as well as space and assets belonging to the institution during the process of conducting this study.

References

- Abidin, N.Z.(2010) Investigating the awareness and application of sustainable construction concept by Malaysian developers. *Habitat Int.* 2010, 34, 421–426
- Afroz T., Hock E.-M., Ernst P., Foglieni C., Jambeau M., Gilhespy L.A.B., Laferriere F., Maniecka Z., Plückerthun A., Mittl P.(2017) Functional and dynamic polymerization of the ALS-linked protein TDP-43 antagonizes its pathologic aggregation. *Nat. Commun.* 2017;8:45
- Alabi, O.A., K.I. Ologbonjaye, O. Awosolu & O.E. Alalade. (2019). Public and Environmental Health Effects of Plastic Wastes Disposal: A Review. *Journal of Toxicology and Risk Assessment.* 5(1): 1-13.
- Berita Harian Online (ahad 16,jun 2019), Rakyat Malaysia hasil 37,890 tan setiap hari <https://www.bharian.com.my/berita/nasional/2019/06/574909/rakyat-malaysia-hasil-37890-tan-sisa-setiap-hari>
- Didik Iswadi , Fatmi Nurisa dan Erlina Liastuti (2017) .Pemanfaatan Sampah Plastik Ldpe Dan Pet Menjadi Bahan Bakar Minyak Dengan Proses Pirolisis. *Jurnal Ilmiah Teknik Kimia UNPAM*, Vol. 1 No. 2 (Juli, 2017) ISSN 2549-0699
- M. Hussam Adeni (2017).Lubricants Dossier – TDS and MSDS for Petronas Lubricants for Gulf Energy Intl. Dossier petronas lubricants ver 6 Julai 2017 update. PETRONAS Lubricants International Sdn
- Jannat, M., S. Akter, & M. Ehsan. (2019). Conversion of Waste Polypropylene Plastic into Fuel. *AIP Conference Proceedings.* 2121: 1–7.
- Kumar, P.S., M. Bharathikumar, C. Prabhakaran, S. Vijayan & K. Ramakrishnan. (2017). Conversion of Waste Plastics into Low-Emissive Hydrocarbon Fuels through Catalytic Depolymerization in a New Laboratory Scale Batch Reactor. *Int J Energy Environ Eng.* 8:167–173.
- Moh YC, Manaf LA (2014) Overview of household solid waste recycling policy status and challenges in Malaysia. *Resour Con-serv Recycl* 82:50–61
- Naimah, S, and N.N Aidha.(2016). "Karakteristik Gas Hasil Proses Pirolisis Limbahplastik Polietilena (Pe) Dengan Menggunakan Katalisresidue Catalytic Cracking (RCC)." *Jurnal Kimia Dan Kemasan* 39(1), 31-38, 2017.doi: <http://dx.doi.org/10.24817/jkk.v39i1.2750>
- Ulrich, Karl T. & Steven D. Eppinger (2001) Perancangan & Pengembangan Produk. Salemba Teknika, Jakarta

MECHANICAL PROPERTIES OF CELLULOSE NANO CRYSTAL/GRAPHENE NANO PLATELETS REINFORCED POLY(LACTIC) ACID BIOCOMPOSITES

Abu Bakar, M. B.

Faculty of Bioengineering and Technology, Universiti Malaysia Kelantan, 17600 Jeli, Kelantan, Malaysia
bashree.ab@umk.edu.my

Mustapha, N. I., Mazli, N. I., Rosdi, N. A. M., Mohd, S. H., Mohamed, M.

Faculty of Bioengineering and Technology, Universiti Malaysia Kelantan, 17600 Jeli, Kelantan, Malaysia
lzzatimustapha98@gmail.com, lzzatimazli20@gmail.com, ainnabil23@gmail.com, hajarmohd97@gmail.com,
mazlan.m@umk.edu.my

Highlights: This innovation is a poly(lactic) acid (PLA) biodegradable plastic composite that has been reinforced with cellulose nano crystal (CNC) and graphene nano platelets (GNP) nano hybrid fillers. The addition of L/GNP nano hybrid fillers has improved the mechanical and thermal properties of the composites. This innovation is expected to be applied in the field of biomedicine such as the production of biomaterials in orthopedics and scaffold.

Key words: *Hybrid nanofillers, mechanical properties, cellulose nano crystals, graphene nanoplatelets, poly(lactic) acid.*

Introduction

Poly(lactic) Acid (PLA) which is a potential bioplastic that provide properties of biodegradability, nontoxicity, biocompatibility, renewability and have comparable mechanical properties to synthetic polymer such as polypropylene, polystyrene and polyethylene can be utilized as substitute to petroleum based-plastic with additional properties [1]. In any case, the utilization of PLA is still limited due to its low crystallization rate, brittleness, low melt strength, what's more, generally high production cost [2].

Hence, there are many methods had been introduced so that the limitation can be overcome include bio and nanocomposite, copolymers, addition of plasticizers and blending with tough polymers so that the properties could be enhanced [3]. Other than that, melt blending PLA with other polymer also can be used but it may contribute to poor mechanical properties of final blend. On the other hands, the nano-sized particles are reasonable materials to be used in composite as reinforcement that it can strengthen the mechanical properties of materials at genuinely low content below than 10 wt.% [4]. With the point of making completely bio-based materials, in the most recent decade, research has been centered, around the utilization of CNC due to their biodegradability, reinforcing capability, abundance and low weight [5].

However, bio-composite containing both matrix and reinforcement from natural sources still has limitation in application due to this completely biodegradable biocomposites do not provide the ideal mechanical properties and stability in aqueous conditions or in high humidity. So, to counter the limitation, the hybridization technique using more than one type reinforcement in the same matrix can be applied. Hence, GNP is a suitable nanomaterial to be used as hybrid nano-filler as it had been reported effectively utilized in PLA biocomposite to increase mechanical, barrier properties and thermal at moderate content, under than 1 wt% [6].

In this study, PLA-CNC/GNP biocomposites had been prepared by fabricating the GNP and CNC with PLA polymer resin by using hot compression moulding. Significant enhancements in mechanical properties of the PLA biocomposites were expected since both CNC and GNP have been known for their excellence reinforcing capability.

Content

The highest incorporation of CNC (5 wt%) had shown significant improvement in tensile modulus that might be due to the reduction of chain mobility that occurred within high filler loading used. A hybridization effect was seen for the PLC2.5G2.5 hybrid biocomposite, as there was a more balance or comparable results in stiffness (tensile modulus) compared with the other biocomposites compositions. This study is important as the development of polymer nanocomposites has been an area of high scientific and industrial interest in the recent years, due to several improvements achieved in biomaterial field. Hybridization of nanofillers in nanocomposites also show unique design possibilities, which offer excellent advantages in creating functional materials with desired properties for specific applications. The innovation is expected to be applied in the field of biomedicine such as the production of biomaterials in orthopedic and scaffold.

Table 1. Formulation of PLA-CNC/GNP Biocomposites

Samples	Compositions		
	PLA (wt%)	CNC (wt%)	GNP (wt%)
PL	100	0	0
PLC5	95	5	0
PLG5	95	0	5
PLC2.5G2.5	95	2.5	2.5
PLC4G1	95	4	1
PLC1G4	95	1	4

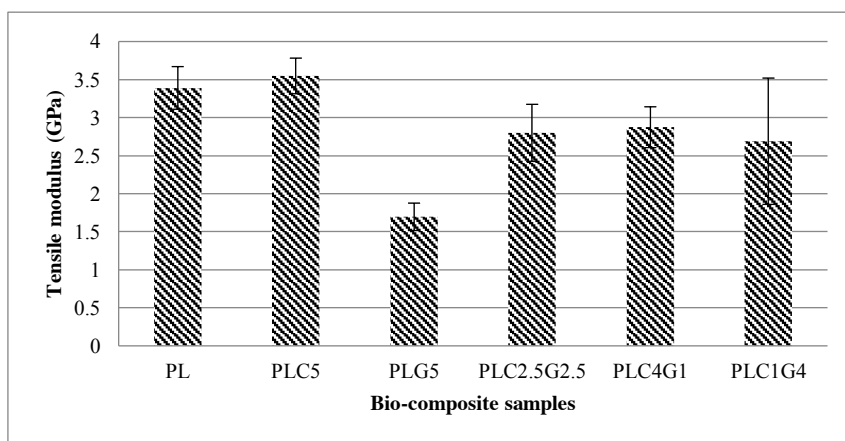

Figure 1. Tensile modulus of PLA and its biocomposites.

Acknowledgement

The author gratefully acknowledges the financial support of the Fundamental Research Grant Scheme (R/FRGS/A1300/01141A/002/2019/00710) Minister of Higher Education, Malaysia.

References

- Chen, T., Wu, Y., Qiu, J., Fei, M., Qiu, R. & Liu, W. (2020). Interfacial Compatibilization via in-situ Polymerization of Epoxidized Soybean Oil for Bamboo Fibers reinforced Poly(lactic acid) Biocomposites. *Composites Part A: Applied Science and Manufacturing*, **138**, 106066.
- Li, J., Xiao, P., Li, H., Zhang, Y., Xue, F., Luo, B., & Jiang, S. (2015). Crystalline Structures and Crystallization Behaviors of Poly(L-lactide) in Poly(L-lactide)/Graphene Nanosheet Composites. *Polymer Chemistry*, **6(21)**, 3988-4002.
- Fenni, S. E., Monticelli, O., Conzatti, L., Doufnoune, R., Stagnaro, P., Haddaoui, N., & Cavallo, D. (2018). Correlating the Morphology of Poly(L-lactide)/Poly(butylene succinate)/Graphene Oxide Blends Nanocomposites with their Crystallization Behavior. *Express Polymer Letters*, **12(1)**, 58-70.
- Chee, W. K., Lim, H. N., Huang, N. M., & Harrison, I. (2015). Nanocomposites of Graphene/Polymers: A Review. *RSC Advances*, **5(83)**, 68014-68051.
- Montes, S., Etxeberria, A., Mocholi, V., Rekondo, A., Grande, H., & Labidi, J. (2018). Effect of combining Cellulose Nanocrystals and Graphene Nanoplatelets on the Properties of Poly(lactic acid) based Films. *Express Polymer Letters*, **12(6)**, 543-555.
- Mittal, V., Chaudhry, A. U., & Luckachan, G. E. (2014). Biopolymer - Thermally reduced Graphene Nanocomposites: Structural Characterization and Properties. *Materials Chemistry and Physics*, **147(1-2)**, 319-332.

EFFECT OF CELLULOSE NANO CRYSTAL AND GRAPHENE NANO PLATELETS ON THERMAL PROPERTIES OF UNSATURATED POLYESTER RESIN REINFORCED KENAF FIBRE BIOCOMPOSITES

Bakar, M. B. A

Faculty of Bioengineering and Technology, Universiti Malaysia Kelantan, 17600 Jeli, Kelantan, Malaysia
bashree.ab@umk.edu.my

Rosdi, N. A. M., Mohd, S. H., Mohamed, M., Abdullah, N. H.

Faculty of Bioengineering and Technology, Universiti Malaysia Kelantan, 17600 Jeli, Kelantan, Malaysia
cinnabil23@gmail.com, hajarmohd97@gmail.com, hajarmohd97@gmail.com, norhakimin@umk.edu.my

Highlights: The thermal properties of hybrid nanocomposites prepared from unsaturated polyester resin (UPE) reinforced with kenaf fibre mat (KFM), cellulose nano crystal (CNC) and graphene nanoplatelet (GNP) was studied. In this study, the KFM-UPE biocomposites with various GNP/CNC hybrid ratio was fabricated by hot press moulding at 120 °C. The thermal behaviour of the biocomposites were characterized by thermogravimetric analysis (TGA) and differential scanning calorimetry (DSC) methods.

Key words: *nanofillers hybrid, thermal properties, cellulose nano crystals, graphene, kenaf fibre, unsaturated polyester resin.*

Introduction

Increasing consumer demand, environment and economics concerns have prompted the engineer and scientist to create new types of composite materials that have superior properties to achieve the new requirements of modern civilizations. Two kinds of nanofillers that were used in this study are cellulose nanocrystals (CNC) and graphene nano platelets (GNP) in the amount of 0-3 wt %. In most previous studies, nanofillers such as CNC and GNP were used widely as composite reinforcement. Both have potential as nano-reinforcing filler for polymer nanocomposites.

CNC has rod-like structures that are derived from native cellulose by isolating crystalline domains with high crystalline levels such as plants and wood while graphene is a material that is made up of carbon atoms [1,2]. In addition, El Miri et al. [3] also found that with the addition of sufficient amounts CNC and graphene in composite are highly effective in nanocomposites to improve their mechanical and thermal properties.

The obtained results revealed that the presence of both GNP and CNC nanofillers has improved the thermal stability of KFM-UPE biocomposites at high temperature and effectively increased the char residue formation. In addition, the TGA and DSC analysis also showed the enhancement of glass transition temperature (T_g) value and degradation temperature for hybrid CNC/GNP reinforced UPE biocomposites as compared to neat UPE and KFM-UPE composites.

Content

With the advance of nanotechnology, researchers have discovered the superiority of using nanofillers in further reinforcing composite. Therefore, an investigation was carried out to investigate the thermal stability of the hybridization of two nanofillers CNC and GNP reinforcing KFM-UPE biocomposites. The composites samples were prepared in dimension of 150 x 150 mm with 5mm of it thickness by hand lay-up method followed by the hot-press molding. Thermal properties of the hybrid composite are evaluated using TGA and DSC. Thermogravimetry was used to observe the thermal stability and degradation, while DSC was used to analyse the glass transition temperature.

The resulting hybrid nanocomposite shows that the combination of two nanofillers do help in improving the composite thermal stability. This study is important as the development of polymer nanocomposites has been an area of high scientific and industrial interest in recent years, due to several improvements achieved in these materials. Hybridisation of nanofillers in nanocomposites also show unique design possibilities, which offer excellent advantages in creating functional materials with desired properties for specific applications. The possibility of using natural resources and the fact of being environmentally friendly have also opened up new possibilities for applications.

Table 1: Composite formulation according to weight percentage (wt.%) of each component.

Sample design	Composite formulation (%)		Nanofiller (wt.%)	
	UPE	KFM	CNC	GNP
Neat UPE	100	-	-	-
KFM/UPE	90	10	-	-
S1	87	10	0.5	2.5
S2	87	10	1.0	2.0
S3	87	10	1.5	1.5
S4	87	10	2.0	1.0
S5	87	10	2.5	0.5
S6	87	10	3.0	0
S7	87	10	0	3.0

Acknowledgement

The author gratefully acknowledges the financial support of the Fundamental Research Grant Scheme (R/FRGS/A1300/01141A/002/2019/00710) Minister of Higher Education, Malaysia.

References

- El Miri, N., El Achaby, M., Fihri, A., Larzek, M., Zahouily, M., Abdelouahdi, K., Barakat, A., & Solhy, A. (2016). Synergistic effect of cellulose nanocrystals/graphene oxide nanosheets as functional hybrid nanofiller for enhancing properties of PVA nanocomposites. *Carbohydrate Polymers*, 137, 239–248. <https://doi.org/10.1016/j.carbpol.2015.10.072>.
- Islam, M. N., & Rahman, F. (2018). Production and modification of nanofibrillated cellulose composites and potential applications. In *Green Composites for Automotive Applications* (pp. 115–141). Elsevier. <https://doi.org/10.1016/B978-0-08-102177-4.00006-9>.
- Katsnelson, M. I. (2016, January 8). Graphene. *Encyclopedia Britannica*. <https://www.britannica.com/science/graphene>.

PHYSICAL PROPERTIES OF CELLULOSE NANOCRYSTAL (CNC) / GRAPHENE NANOPATELETS (GNP) HYBRID NANOFILLERS REINFORCED POLYLACTIC ACID BIOCOMPOSITES

Abu Bakar, M. B.

Faculty of Bioengineering and Technology, Universiti Malaysia Kelantan Kampus Jeli, 17600 Jeli, Kelantan, Malaysia
bashree.ab@umk.edu.my

Mazli, N. I., Mohd, S. H., Md Akil, H., Rosdi, N. A. M.,

Faculty of Bioengineering and Technology, Universiti Malaysia Kelantan Kampus Jeli, 17600 Jeli, Kelantan, Malaysia
School of Materials and Mineral Resources Engineering, Engineering Campus, Universiti Sains Malaysia, 14300 Nibong
Tebal, Penang, Malaysia
izzatimazli20@gmail.com, hajarmohd97@gmail.com, hazizan@usm.my, ainnabil23@gmail.com,

Highlights: Cellulose nanocrystal (CNC) and graphene nanoplatelets (GNP) were chosen for this study due to their high potential for use as reinforcement due to their biodegradable and eco-friendly properties, as well as the physical properties over PLA biocomposites. CNC/GNP as hybrid nanofillers, reinforced PLA was successfully manufactured using compression molding (PLA) at 180°C. As a result, the physical properties of CNC/GNP hybrid nanofillers reinforced PLA have been analyzed for density and water absorption.

Keywords: Cellulose Nanocrystal, Graphene Nanoplatelets, Polylactic Acid, Physical Properties, Density, Water Absorption

Introduction

Ecological and environmentally friendly bio-based materials are gaining popularity as a replacement for traditional plastics. Polylactic acid (PLA) has gotten a lot of attention recently because it is a viable replacement candidate that is biodegradable, biocompatible, and melt-processable [1]. To create a fully organic biocomposite based on PLA, cellulose nanocrystals (CNC) and graphene nanoplatelets (GNP) were dispersed together in the PLA polymer matrix as hybrid nanofiller.

CNC are rod-like structures made from native cellulose by isolating crystalline domains with high crystalline levels, such as those found in plants and wood. Because of its unique mechanical and barrier properties, low density, and sustainability, CNC has sparked interest in textile, packaging, and biomedical applications [2,3]. On the other hand, according to Scaffaro et al., [4] the use of GNP as fillers in PLA-based composites protects the polymer from thermal degradation and photo-oxidation during processing and use, and also has the potential to improve PLA's breaking properties.

The results indicate the addition of CNC and GNP as hybrid nanofiller reinforced PLA improved the physical properties. The density of the CNC/GNP-PLA biocomposites decreases with the addition of CNC and GNP. Meanwhile, because CNC is hydrophilic in nature, water uptake for biocomposites increases as the CNC loading and the immersion time increases.

Content

Hybrid nanofiller CNC/GNP was used 0-5 wt %. CNC/GNP/PLA was successfully fabricated using compression molding at 180°C. The physical properties were determined by density and water absorption test. For water absorption test, PLC5 has the highest value of water uptake which 1.14%. Meanwhile for density, the presence of the maximum loading of GNP in PLA (PLG5) has shown the highest density with 1.2666g/cm³.

The addition of CNC/GNP in PLA biocomposites showed decreasing in density. This is may influenced by the variation in the molecular weight and high volume of the biocomposites. Then, PLC5 has higher water absorption due to CNC is hydrophilic which is tend to absorb water or moisture from surrounding environment.

This study is important as the development of polymer nanocomposites has been an area of high scientific and industrial interest in the recent years, due to several improvements achieved in these materials. Hybridization of nanofillers in nanocomposites also shows unique design possibilities, which offer excellent advantages in creating functional materials with desired properties for specific applications. This study is expected for various applications such as food packaging and water bottles to replace the petrochemical based plastic in the future.

Table 1: Compositions of PLA, CNC, and GNP in biocomposites samples

SAMPLES	COMPOSITIONS		
	PLA (wt%)	CNC (wt%)	GNP (wt%)
PL	100	0	0
PLG5	95	0	5
PLC1G4	95	1	4
PLC2.5G2.5	95	2.5	2.5
PLC4G1	95	4	1
PLC5	95	5	0

Acknowledgement

The author gratefully acknowledges the financial support of the Fundamental Research Grant Scheme (R/FRGS/A1300/01141A/002/2019/00710) Minister of Higher Education, Malaysia.

References

- Sun, Z., Zhang, L., Liang, D., Xiao, W., & Lin, J. (2017). Mechanical and Thermal Properties of PLA Biocomposites Reinforced by Coir Fibers. *International Journal of Polymer Science*, 1–8.
- Klemm D, Heublein B, Fink H-P et al (2005). Cellulose: Fascinating Biopolymer and Sustainable raw material. *Angew Chem Int Ed* 44:3358–3393
- S. Xie, X. Zhang, M. P. Walcott and H. Lin (2017) Cellulose nanocrystals (CNCs) applications: a review, *Material Engineering. Eng. Sci.*, 2, 4-16.
- Scaffaro, R., Botta, L., Maio, A., Mistretta, M. C., & La Mantia, F. P. (2016). Effect of Graphene Nanoplatelets on the Physical and Antimicrobial Properties of Biopolymer-Based Nanocomposites. *Materials (Basel, Switzerland)*, 9(5), 351.

DEGRADATION OF METAMIFOP BY $\text{TiO}_2/\text{Al}_2\text{O}_3/\text{CNT}$, $\text{TiO}_2/\text{Al}_2\text{O}_3/\text{G}$ AND $\text{Al}_2\text{O}_3/\text{G}$

Nik Raihan Nik Yusoff

Faculty of Earth Science, Universiti Malaysia Kelantan, Jeli Campus, Jeli, Kelantan, Malaysia
Email address: nrailhan@umk.edu.my

Mahani Yusoff, Rozidaini Mohd Ghazi, Asanah Radhi, Nik Nurul Anis, Musfiroh Jani, Noor Janatun Naim, Marinah Muhammad

Faculty of Bioengineering and Technology, Universiti Malaysia Kelantan, Jeli Campus, Jeli, Kelantan, Malaysia
mahani@umk.edu.my, rozidaini@umk.edu.my, asanah@umk.edu.my, anis.ny@umk.edu.my, musfiroh@umk.edu.my, janatunnaim@umk.edu.my, marinah@umk.edu.my

Highlights: Titanium dioxide (TiO_2) has been used in photocatalysis for water and waste water treatment. Photocatalytic degradation of pollutant using photocatalyst TiO_2 commonly utilize UV light only to produce hydroxyl radical which leading to high cost when we want to treat high amount of pollutant using UV light. Furthermore, it has large band gap (3.2 eV) and only works under UV light and not in visible light. Hence, there is a need to modify the TiO_2 with the addition of alumina (Al_2O_3), carbon nanotube (CNT) and graphene as the hybrid nanocomposite. The addition of alumina, CNT and graphene act as supporter as the application of TiO_2 powder without supporter make it hard to recover back after application. The performance of the produced photocatalyst was observed by degrading metamifop herbicide that used to control weeds in paddy field.

Key words: photocatalytic degradation, TiO_2 , alumina, graphene, metamifop

Introduction

Titanium dioxide (TiO_2) has been used in photocatalysis for water treatment. However, it has large band gap (3.2 eV) and only works under UV light and not in visible light. Hence, there is a need to modify the TiO_2 with the addition of alumina (Al_2O_3), carbon nanotube (CNT) and graphene as the hybrid nanocomposite. The production of the hybrid nanocomposite photocatalyst via hydrothermal process in autoclave at low temperature (200°C). The development of the hybrid nanocomposite is a need to solve the major drawback on the recovery of the TiO_2 powder. Furthermore, the addition of the stated material also helps in lowering band gap energy and later able to being applied under UV light or visible light. However, in this innovation, the performance of the hybrid nanocomposite photocatalyst was tested for UV light only.

Content

Photocatalytic degradation of pollutant using photocatalyst TiO_2 commonly utilize UV light only to produce hydroxyl radical which leading to high cost when we want to treat high amount of pollutant using UV light. Furthermore, application of TiO_2 without supporter makes it hard to recover back after application. Due to this, innovation has been made as shown in Figure 1. The TiO_2 hybrid nanocomposite photocatalyst was prepared according to its ratio mixture. Then the mixture compositions were then premixed using ball milling for an hour. Next, about 100 ml of NaOH (1 M) was added to the mixture and stirred for 30 minutes later proceed to the hydrothermal process at 200°C in an autoclave for 24 hours. Later, the photocatalysts were washed using 200 ml of 0.1 M HCl. The washing process was continued by distilled water until washing solution reached pH 7. The prepared photocatalysts were obtained and dried 24 hours in the oven at 80°C. The photocatalytic performances of the hybrid photocatalyst nanocomposites were evaluated in degrading metamifop solution.



Figure 1: Innovation of TiO_2 hybrid nanocomposite photocatalyst.

The performances of the hybrid nanocomposite photocatalyst in degrading metamifop were promising with high degradation percentage as shown in Table 1.

Table 1: The percentage degradation value of the various types of hybrid nanocomposite photocatalysts.

Photocatalyst (amount used: 20 mg each type)	Condition of pollutant	Degradation%
TiO ₂ /Al ₂ O ₃ /CNT (Nik Yusoff <i>et al.</i> , 2020)		95.0%
TiO ₂ /Al ₂ O ₃ /G (Nik Yusoff <i>et al.</i> , 2019)	metamifop 10 ppm, UV light, 2 L/min of air	95.3%
Al ₂ O ₃ /G (Wong <i>et al.</i> , 2017)		97.2%

It was proven that the produced photocatalyst capable to give high percentage degradation on metamifop as tabulated in Table 1.

The photocatalysts also has other advantages where they can be reusable after regeneration process. It also has been registered as copyright IP under MyIPO since year 2020.

According to the cost analysis, the production cost for 100g of photocatalyst powder is just RM125, which is the lowest price among other inventors such as Merck, Crsytal Global, Tronox and others.

In term of other commercial value, these photocatalysts are currently being used to treat effluent from food processing and dye from textile sector (Isa *et al.*, 2018) under the utilization of visible light rather than UV light as shown in Figure 1.

Acknowledgement

The authors thank Faculty of Earth Science and Faculty of Engineering and Technology, University Malaysia Kelantan for providing all facilities and excellent technical assistance for the completion of this research.

References

- Isa, N. F. M., Nik Yusoff, N. R., Razali, M. H. and Yusoff, M. (2018). Photocatalytic activity of hydrothermally synthesized Al₂O₃ graphene naocomposite. *IOP Conf. Ser.: Mat. Sci. Eng.* 440 012017.
- Nik Yusoff, N. R., Wen, L. P., Yusoff, M., Balqis, N. A., Mohd Ghazi, R. and Jani, M. (2020). Performance of TiO₂/Al₂O₃/carbon nanotube nanocomposite on the photocatalytic degradation of metamifop. *IOP Conf. Ser.: Earth Environ. Sci.* 596 012069.
- Nik Yusoff, N. R., Peng, C. Y., Yusoff, M. and Mohd Nor, S. N. H. (2019). Photocatalytic degradation of metamifop using TiO₂/Al₂O₃/G nanocomposite. *AIP Conf. Proceedings* 2068 020034.
- Wong, J. K. M. (2017). Photodegradation of metamifop using alumina-graphene nanocomposite (Bachelor dissertation, Universiti Malaysia Kelantan).

FOOD PACKAGING BIOPLASTIC FILM FROM COCOA POD HUSK INCORPORATED WITH SUGARCANE BAGASSE

Siti Nuurul Huda Mohammad Azmin

Faculty of Agro-Based Industry, Universiti Malaysia Kelantan Jeli Campus, 17600 Jeli Kelantan, Malaysia.
huda.ma@umk.edu.my

Najah Aliah Mohd Hayat

Faculty of Agro-Based Industry, Universiti Malaysia Kelantan Jeli Campus, 17600 Jeli Kelantan, Malaysia.
najah.ma@umk.edu.my

Highlights: Agricultural wastes, including cocoa pod husk (waste from the chocolate industry) and sugarcane bagasse (waste from the sugar industry), are increasing day by day. The development of food packaging biofilms from these two wastes could be beneficial to the environment and human. Therefore, this study was conducted to develop biodegradable plastic films by using cocoa pod husk and sugarcane bagasse. Cellulose and fibre were extracted from cocoa pod husk and sugarcane bagasse, respectively. The physicochemical properties were determined in terms of sensory evaluation, drying time, moisture content, water absorption and water vapor permeability. From the observation and analysis of the physicochemical properties of bioplastic, we found that this bioplastic film is suitable for food packaging, as it demonstrated the lowest water absorption percentage and water vapor permeability.

Key words: *agricultural waste; cocoa pod husk; sugarcane bagasse; bioplastic film; water absorption; moisture content.*

Introduction

In recent years, the enthusiasm for the development of bioplastics has become more substantial and more significant under the idea of "waste to wealth". The utilisation of biomass like fibre, cellulose and starch to replace petrochemical materials for the production of plastics, is a widely accepted strategy to establish a sustainable society (Fiorentino, Ripa, & Ulgiati, 2017; Ilyas et al., 2019; Karan, Funk, Grabert, Oey, & Hankamer, 2019; Scott & Buchard, 2019). Bioplastics or biodegradable polymers can be defined as plastics which are made from biomass (Saharan & Sharma, 2012).

The bioplastic production saves fossil fuels, reduce carbon dioxide emission and plastic pollution in the environment (Abdul-Latif, Ong, Nomanbhay, Salman, & Show, 2020). The biodegradability of bioplastic is widely publicised. The packaging demand is increasing among retailers and in the food industry. It is because conventional plastic not only takes many years to degrade, but it also produces toxins during degradation. However, the high production cost and the availability of the low-cost petrochemical-based plastic led to the negligence of bioplastic.

Bioplastic production cost is higher than the conventional plastics (Petersen et al., 1999). However, the use of bioplastic can reduce the environmental impact of plastics primarily in relating to the toxic pollutant from non-degradable plastics, and the amount of carbon dioxide emitted. Consequently, the greenhouse that caused global warming is reduced since increasing bioplastic feedstock balance of carbon dioxide in the atmosphere. Some bioplastics have properties similar to those of traditional counterparts (Dietrich, Dumont, Del Rio, & Orsat, 2017). However, these properties must be tested and examined.

Acknowledgement

This study was financially aided by the Ministry of Education Malaysia, Fundamental Research Grant Scheme for Research Acculturation of Early Career Researchers (FRGS-RACER, R/FRGS/A0700/01552A/003/2019/00665) and Universiti Malaysia Kelantan, UMK Prototype Research Grant (UMK-PRO 2020, R/PRO/A0700/01552A/004/2020/00872). These supports are gratefully acknowledged.

References

- Abdul-Latif, N.-I. S., Ong, M. Y., Nomanbhay, S., Salman, B., & Show, P. L. (2020). Estimation of carbon dioxide (CO₂) reduction by utilization of algal biomass bioplastic in Malaysia using carbon emission pinch analysis (CEPA). *Bioengineered*, 11(1), 154–164.
- Dietrich, K., Dumont, M.-J., Del Rio, L. F., & Orsat, V. (2017). Producing PHAs in the bioeconomy—Towards a sustainable bioplastic. *Sustainable Production and Consumption*, 9, 58–70.
- Fiorentino, G., Ripa, M., & Ulgiati, S. (2017). Chemicals from biomass: technological versus environmental feasibility. A review. *Biofuels, Bioproducts and Biorefining*, 11(1), 195–214.
- Ilyas, R. A., Sapuan, S. M., Ibrahim, R., Atikah, M. S. N., Atiqah, A., Ansari, M. N. M., & Norrahim, M. N. F. (2019). Production, processes and modification of nanocrystalline cellulose from agro-waste: a review. In *Nanocrystalline Materials*. IntechOpen.
- Karan, H., Funk, C., Grabert, M., Oey, M., & Hankamer, B. (2019). Green bioplastics as part of a circular bioeconomy. *Trends in Plant Science*, 24(3), 237–249.

SMART VIEW AND ANTIFUNGAL ENTO CABINET (SVAFEC)

Norashikin Fauzi

Universiti Malaysia Kelantan, Jeli Campus, 17600 Jeli, Kelantan
ashikin@umk.edu.my

Noor Syuhadah Subki, Zaitul Zahira Ghali@Ghazali, Musfiroh Jani

Universiti Malaysia Kelantan, Jeli Campus, 17600 Jeli, Kelantan
syuhadah@umk.edu.my, zaitulzahira@umk.edu.my, musfiroh@umk.edu.my

Highlights: This article highlights on an effective entomology cabinet with a smart view of high visibility screening and antifungal treatment by using UV light radiation. This innovation is meant to introduce a modern entomology storage/cabinet that capable to combat fungal infestation on museum collection particularly on fragile and delicate insect specimen.

Key words: *smart entomology cabinet, uv light, antifungal, insect specimen*

Introduction

Insect collections are becoming even more important to taxonomic and conservation studies. Much effort is spent to maintain collections and prevent damage from fungal infestation. Fungi is a significant problem for any collection and it damages specimens, makes them visually unappealing, and renders them useless for research. For fungal development they could survive in lower relative humidity than bacteria and could produce spores easily dispersed with moving air. Fungicidal effects of UV light irradiation on museum collection was found to be effective in combating fungal infestation.

Normally, the Insectarium stored hundreds of insect specimens. Most of the specimens were deposited for educational and research purposes. Nevertheless, the widespread mold grow on specimens across several orders of insects and in all the containers. This infection was most likely caused by the addition of specimens that were killed and stored in a freezer, then pinned without providing adequate time for accumulated condensation to dry. The mold consisted of grey hyphae and fruiting bodies covering several specimens in all the boxes.

Apart from that, the regular inspection on the specimens had triggered vibration and caused several damaged on the fragile, delicate and aged specimens. The vibrations occurred when the drawers were pulled out from the cabinet manually, subsequently it disturbed the collection stay level and damaged the structure of the insect morphology particularly the soft wings and antennae. The current condition of entomology cabinet is that it poses no window for clear visibility screening. The drawers were arrange closed to each other and this require curator to inspect the specimens by pulling drawers one by one manually. This practice could be improved by innovating a holistic solution for both fungal infestation and low visibility screening.

Content

1. Description of product development.

The cabinet will be incorporated with a tinted glass viewing panel on the door. For a quick screening or inspection of the specimen within the cabinet, the curator just knock on the door to clear up the glass and illuminate the inside of the cabinet. If fungal infestation is found during inspection, the UV radiation tube lights inside the cabinet will be switch on to inactivate the fungi.

This study is aimed to innovate a holistic solution in combating fungal infection on insect specimens by building a smart view and antifungal entomology collection storage using UV radiation tube lights (figure 1). The cabinet will be incorporated with a tinted glass viewing panel on the door. For a quick screening or inspection of the specimen within the cabinet, the curator just knock on the door to clear up the glass and illuminate the inside of the cabinet. If fungal infestation is found during inspection, the UV radiation tube lights inside the cabinet will be switch on to inactivate the fungi.

Figure 1: Smart View and Antifungal Ento Cabinet (SVAFEC)

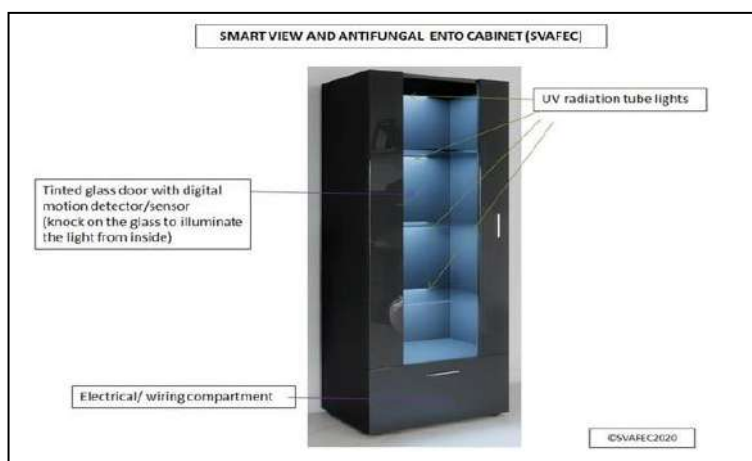

2. The importance of product development.

Through this development of SVAFEC:

- i) The stored specimens could have a longer shelf life as compared to the traditional entomology cabinet. Such items are collected and preserved because they form a rich foundation upon which to study the natural world by, for example, providing the basis for identification of organisms, mapping their distribution and providing the means for facilitating research led conservation. By storing the physical object and not only an image or description of the natural organism, specimens collections aim to maximize the possibilities for new scientific discoveries (Dincă et al., 2011; Pittino, 2006).
- ii) The monitoring and maintain of the specimens could be done in a convenient way without causing too much vibration or destruction on the stored specimens. Well preserved specimens in this SVAFEC can be used for environmental monitoring and provides a more appropriate platform for study (Ownes and Duin, 2008).

3. Advantages of the product development towards education and community

- i) It will ease the burden of inspecting and promote time saving insectarium inspection. Curator just simply knocks on the glass door and the light will automatically be switched on. Hence, the curator could clearly inspect the specimens without causing any damages to the specimens.
- ii) Enable to combat fungal infestation on stored specimens by using the UV light.

4. Commercialization potential of the product.

- i) Museum
- ii) Research institution
- iii) Public and private institution.

Acknowledgement

We would like to thank you to Faculty of Earth Science, UMK for supporting our journey in promoting smart technology in developing a modern entomology cabinet.

References

- Dincă, V., Lukhtanov, V.A., Talavera, G. and Vila, R. (2011) Unexpected layers of cryptic diversity in wood white *Leptidea* butterflies. *Nature Communications*. 2, p.324 [doi:10.1038/ncomms1329].
- Ownes, S. and Duin, D. (eds.) (2008) Workshop report. M4.2.8a Broadening the user base of natural history collections (DRAFT). An EDIT WP4 and SYNTHESIS NAC initiative. Hosted by the Royal Belgian Institute of Natural Sciences, Brussels. November 4-5, 2008
- Pittino, R. (2006) A revision of the genus *Psammoporus* Thomson, 1859 in Europe, with description of two new species (Coleoptera Scarabaeoidea: Aegialiidae). *Giornale Italiano di Entomologia*. 11, pp.325-342.

TWO RODS FISHING BAIT LAUNCHER

Mohd Hafidzal Mohd Hanafi

Faculty of Mechanical Engineering, Universiti Teknikal Malaysia Melaka, Hang Tuah Jaya,
76100, Durian Tunggal, Melaka, Malaysia
hafidzal@utem.edu.my

Muhammad Nur Ariffuddin Nuruddina, Fadhilah Shikh Anuar, Nurul Hilwa Mohd Zini, Mohd Noor Asril Saadun

Faculty of Mechanical Engineering, Universiti Teknikal Malaysia Melaka, Hang Tuah Jaya,
76100, Durian Tunggal, Melaka, Malaysia
ariffkudin@gmail.com, fadhilah@utem.edu.my, nurulhilwa@utem.edu.my, asril@utem.edu.my

Highlights: Fishing is a human activity that is necessary for human survival, as well as an activity that many people like doing in their spare time. Angler may also be used to catch fish from the shore, and it is designed to be lightweight and portable. The aims of this project is to design and fabricate a user-friendly air bait launcher. A benchmark that choose to do Pugh technique is used to determine which design is the best for support and three conceptual designs have been developed. As a conclusion dual rods fishing bait launcher is successfully fabricated.

Key words: Fishing, Angler, bait, sea, surfing, hook

Introduction

This study and observation are aimed at helping fishing anglers and improving the design that has been made for the air bait launcher. This air bait launcher is a little heavy for the angler to carry for a long time. Probably, the angler has to carry this air bait launcher until the fish gets it. The fishermen also do not know how long it takes for a fish to eat the bait. Therefore, if they have to keep the air bait launcher for a long time it makes the anglers a little bit tired. Furthermore, it is also a little difficult for anglers to set up the lure since it must hold the air bait launcher and the fishing rod. Air bait launcher can be divided by three parts and one. The parts are Barrel/Launcher, air tank, trigger, and supporter. Figure 1 shows the two rods fishing bait launcher after finished fabricated.



Figure 1. Two rods Fishing bait launcher

Benchmarking

Benchmarking is a method of measuring the result of this study compared by the product marketed. For this project, many products will be used as a benchmark for us to use as benchmarking products. The benchmarking will make it easier for us to get the conceptual design done. This product survey also is done by exploring the market for this product and checking it on the website. It has been produced in many countries for this company. It also uses various materials that rely on the manufacturer. Some benchmarks for this product is listed before design is conducted (Jelnicki & Mills, 2009), (Younto, 2014) and (Richard, 2017).

Conceptual Design

The first stage of the product design process is conceptual design. In this process sketching drawings and other diagrams or models are used. Compilation of integrated ideas, principles and function help to provide an overview of the proposed product. The final design of two rods fishing bait launcher is based on some conceptual designs. To determine our final design, the Pugh method has been chosen to use. Each conceptual design will be contrasted by the Pugh process. The score will be based on the chosen benchmark. Benchmark as shown in Figure 2 below is the final design that was selected

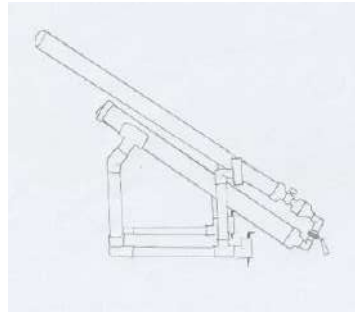

Figure 2 Final design of product from conceptual design

Design Development

The reason this design is the best because it more stable and have movement restrain at support of Air Bait Launcher. The movement restrain at the supporter make the angler more confident about the supporter while put the fishing rod and using the Air Bait launcher because of the using the nail to make the supporter not move. The stand is light weight because of using PVC material and it can withstand the pressure load from the Air Bait Launcher and two fishing rods. The fishing rods size of this design is medium and suitable with size of fishing rod. Other than that, the Air Bait Launcher and the supporter not joined, and the product can be use or trigger while put the Air Bait Launcher on supporter or separately so it will give angler more freedom on how to use it. The orthographic and isometric design of the product is shown in Figure 3.

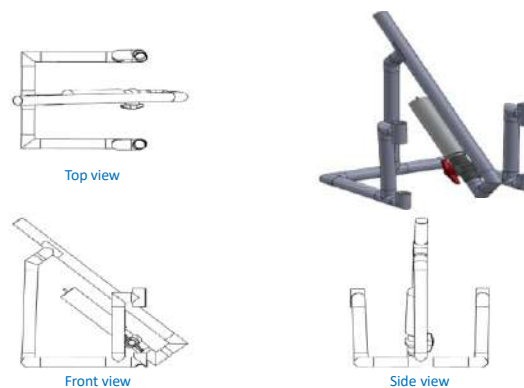

Figure 3 Orthographic and isometric views for two rods fishing bait launcher

Conclusion

Two rods fishing bait launcher is successfully designed and fabricated to help the person who love fishing. Benefits of this product is lightweight and easy for the angler to carry it. This product also can be located at the beach and riverside. This product has high possibility to be commercialized in future.

Acknowledgement

Authors are grateful to Universiti Teknikal Malaysia Melaka (UTeM) for the financial support.

References

- Jelnicki & Mills (2009, July). Air Bait Cannon Shooter. <https://patents.google.com/patent/US20090178329A1/en>
 Younto (2014, December 30). How to build an air powered bait cannon. <https://www.youtube.com/watch?v=-QKVbWwrTel&t=23s/>
 Richard, A. (2017, September 22). Bait launcher cannon three tests firings. <https://www.youtube.com/watch?v=RwrhZbVIVNg>

THE CEILING FAN CLEANER

Mohd Zaidi bin Mahmud

Politeknik Kota Bharu, Ketereh, Malaysia
mzaidi@pkb.edu.my

Zahidi Bin Hibadullah

Politeknik Kota Bharu, Ketereh, Malaysia
zahidi@pkb.edu.my

Highlights: The theme of this project is chosen because of today's technology that is more precisely designed to design a ceiling fan that utilizes electricity and individual power. Additionally, study the ceiling capability of the ceiling fan. The work steps for producing these ceiling kits are designing projects, material selection, and data analysis testing and project generation. Based on the project carried out from the whole it can be concluded with the main objective of designing a ceiling fan with an electric power and the power of an individual has been achieved. The purpose of the project is to facilitate users in maintaining the ceiling fan in their respective places.

Key words: *cleaner, ceiling fan, electricity, equipment maintainer, technology*

Introduction

Increasingly, a variety of sophisticated designs are produced. The needs of users who want comfort and further simplify the work they want to do always make the designers shape the best results for user satisfaction in the future. In the design process from the beginning to the final product, many studies need to be taken into account. The thing to think about is how and what methods should be used to ensure that products and results that successfully meet the needs of consumers can be produced.

The idea of designing a product is triggered when you see a problem that arises everywhere, especially at home. The impact of the problem has led us to design a device called a ceiling fan cleaner. There are some problems that everyone often experiences when they often want to wash a ceiling fan.

Content

Description of the innovation

The objectives of a project play an important role in a report. The targeted goals of the project should be clearly stated and detailed. In this project, a creative and effective project is the driving force of its success. The objectives for the design of this "Ceiling Fan Cleaner" such as saves time to do the cleaning process, save energy by not having to use stairs to do the process clean the ceiling fan, facilitate further the process of cleaning or work for women or old people to clean the fan and lastly, there is no need to sweep the dirt that falls on the floor because of the dirt residue have been collected in a container or cloth that has been prepared at the end. The scope of work that has been set is to further facilitate the work done. It has been design an ergonomic and systematic ceiling fan washer, design and build the details that need to be thought through to build mechanism, prepare drawings related to the tool to be created, find out more about the ingredients to be used for process the project, know the size and weight of the project to be produced and lastly, generate a model.

The importance of this innovation to education

This innovation is important for our education system especially for those who involve in engineering side. This invention applies a combination of electrical, electronic, mechanical and related engineering. Knowledge applied along with skills in the field of engineering is crucial to the needs of the industry and the growing generation of technology. This is very important in the education system in Malaysia in producing an intelligent generation in the field of science and technology which in turn contributes towards the development of the country.

Advantages of the innovation towards education and community

This innovation is very beneficial for both teachers and students. It is important for teachers. This innovation is very important to teachers in applying existing skills and knowledge. The knowledge from the teacher is channeled to the students through the resulting project. The students are able to understand the engineering concepts involved as well as the knowledge learned can be applied in the project developed. This basic combination of teacher and learner is needed in the education system in Malaysia to drive the economy especially in the field of engineering involved.

Commercial value in terms of marketability or profitability of the innovation

This innovation is marketable to all users that used the ceiling fan in house, office and etc. designed innovations are invaluable if appreciated by the parties involved in facilitating consumer affairs in daily life. The ideas used can be applied in daily life as well as simplify the way of ceiling fan maintenance. This innovation is very valuable if improved by stakeholders through the right process in producing ceiling fan equipment maintenance products.

References

- Diaz M., Martin C., Rubio B.(2016). State-of-the-art, challenges, and open issues in the integration of Internet of things and cloud computing. *Journal of Network and Computer Applications*, Vol. 67, pp. 99-117.
- Hoey, J.; Poupart, P.; von Bertoldi, A.; Craig, T.; Bouillier, C.; Mihailidis, (2010). A. Automated handwashing assistance for persons with dementia using video and a partially observable markov decision process. *Comput. Vis. Image Underst.* 114, pp. 503–519.
- Narendiran, A.; Nandan, M.M.; Naveen, B. (2018) Cognitive Assistance in Smart Homes to Model the Progression of Alzheimer Disease. *J. Adv. Res. Appl. Sci.*, volume 5, pp. 149–163.

PORTABLE ELECTRIC GENERATOR

Norlila binti Mohd Yusoff

Politeknik Kota Bharu, Kok Lanas, Kelantan
norlila@pkb.edu.my

Masarizan binti Mohamed, Syahmi Adib bin Nazri, Muhammad Nur Aiman bin Mohd Zulkifli

Politeknik Kota Bharu, Kok Lanas, Kelantan
sarizan@pkb.edu.my, syardib29i@gmail.com, aimanzulkifli@gmail.com

Highlights: Innovation is built to meet the needs of today which serves as a very important storage of portable electricity in today's modern and sophisticated world. This innovation project is a prototype built by recycling used electrical goods to produce a device that provides convenience when travellers are named 'Portable Electric Generator'. It has various functions other than charging electronic devices such as smartphones. 'Portable Electric Generator' is an innovation project designed to encourage and promote Recycling as recommended by the Malaysian government. This innovation can also be used by all users who have electronic gadgets during the adventure because it is portable and has various functions. This tool can be used anywhere regardless of time. This prototype helps during times of emergency such as blackouts or when in a dark forest. In addition, this device also simplifies the process of lighting a fire and can also be used to charge various electronic devices that use a Universal Serial Bus (USB) cable connection.

Key words: *Portable Electric Generator, Universal Serial Bus (USB), electronic, gadgets, prototype,*

Introduction

The use of smartphones, gadgets and electronic equipment is very widespread and very important in our daily lives. These appliances mostly require batteries to function and require an electrical source to recharge so that the electronic equipment can be reused. Mostly it uses a USB (Universal Serial Bus) cable to increase battery capacity. Therefore, the 'Portable Electric Generator' was created to solve problems during times of emergency such as power outages or when in the forest because it is a versatile device that can store electricity supply. 'Portable Electric Generator' is able to solve consumer problems while getting real supply. This innovation is built to meet the needs of today which serves as a very important portable electrical power store in today's modern and sophisticated world.

This innovation project is a prototype built by recycling used electrical items to produce a device that provides convenience during emergencies during travel or power outages. It can be used as an emergency light as well as a device to light a fire in addition to its main function as a store of electrical energy that can charge the battery of most electronic equipment that uses a USB cable or Universal Serial Bus.

Methods of innovation implementation

The main objective of this device was created is to provide convenience to travellers and backpacker travellers to access electricity even in places far from electricity sources. This product helps them to organize their time while getting a good and adequate supply of electricity. This equipment can also be used as an Emergency Lighting as well as a device to light a fire that is built using recycled used items while reducing environmental pollution.

This Portable Electric Generator is developed using recycled used materials such as plastic bottles, plastic spoons and white PVC (polyvinylchloride) pipes which serve as the main external and internal construction of the product. While transformers, CFLs (Compact Fluorescent Lamps) electronic circuits, LEDs (Light Emitting Diodes), and cable connectors are used as building materials in the interior that will serve as product output as emergency lighting as well as stored electrical power supply signals. Apart from that, the project also uses other materials such as switches, heating coils, electric charger circuits, aquarium air pump magnets, electronic power bank circuits as well as used telephone batteries to store and supply electrical power when needed.

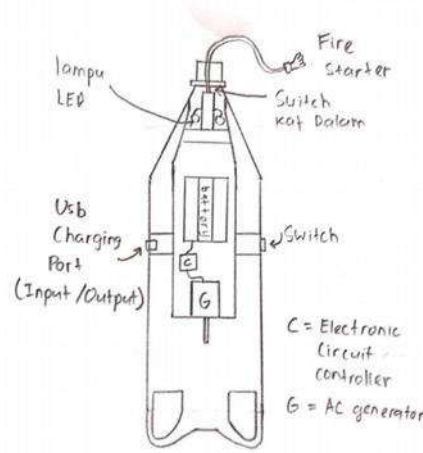

Figure 1: Cross -sectional diagram of a prototype of a Portable Electric Generator

Advantages

Portable Electric Generator is the only innovation product built to have various advantages of its own. It is a multi-functional product such as an electrical appliance charger, as an emergency light and also used as a device to light a fire as well as having safety features. It is very economical and features green technology because the entire product is built using second -hand and recycled items to help reduce environmental pollution. This product also has its own special features because it uses two methods for recharging the electricity supply, namely using a plug -in electricity supply and using a drainage system either tap water or natural water flow (river). In addition, this product is very suitable for use anytime and anywhere because it is portable when electronic equipment needs electricity to increase the battery. While the use of a USB port makes it work well when needed as most electrical or electronic appliances use a USB cable to connect to the power supply.

Suggestions for improvement

This product can be produced and made using better quality and agronomic goods. The shape of this product can be changed according to the suitability of customer demand from small size to large size.

References

- ARM Isa, YM Daud, R Zainal (2006). *Elektronik Asas Litar Arus Terus dan Arus Ulang-Alik*. UTM,
ARM Isa. (2006), *Asas Perhubungan Elektronik*. UTM.
Ron Lenk. (1998). *Practical Design of Power Supplies*. McGraw-Hill,
Ron Lenk & Carol Lenk (2017). *Practical Lighting Design with LEDs*. John Wiley & Sons

BRIDGE TESTING APPARATUS (BRIDGTEST)

Noor Hazwani Binti Sapuan

Kolej Matrikulasi Johor, Johor, Malaysia
bm-1364@moe-dl.edu.my

Farha Binti Mohamed Yasin, Mohd Yusri Bin Yusop, and Zulkiflie Bin A Wahab

Kolej Matrikulasi Johor, Johor, Malaysia
bm-1397@moe-dl.edu.my, bm-1398@moe-dl.edu.my, bm-1322@moe-dl.edu.my

Highlights: Bridge testing apparatus or Bridgtest is an innovative design of a conventional tester which is used to evaluate bridge strength during bridge building competition. From our observation and interviews with user, it is found that conventional tester has some deficiencies in term of inaccuracy in testing of bridge strength, quality of material used, size and a large number of weights needed to test the bridge. This study aims to create an improved version of tester which is more strong, durable and more importantly it enhances the accuracy of bridge testing procedure. As the result of the innovation, the Bridgtest is able to test 135 kg of the maximum load sustained by the bridge and it also reduce the manufacturing cost and easy to maintain. In conclusion, Bridgtest is a perfect equipment to be used as the bridge tester for bridge building competition as it benefited both participants and event organizer.

Key words: *STEM education, bridge tester*

Introduction

STEM education gives people skills that make them more employable and ready to meet the current labor demand (Shahali, Ismail & Halim, 2017). It encompasses the whole range of experiences and skills. Each STEM component brings a valuable contribution to a well-rounded education. Science gives learners an in-depth understanding of the world around us. It helps them to become better at research and critical thinking. The STEM approach to education fosters creativity and divergent thinking alongside fundamental disciplines. It motivates and inspires young people to generate new technologies and ideas. With a focus on practice and innovation, students get to learn from inquiry-based assignments. STEM education gives an understanding of concepts and encourages knowledge application. To keep it short, its aim can be formulated in two simple actions: explore and experience. Students are free to exercise what they learn and embrace mistakes in a risk-free environment. Project-based learning and problem-solving help learners to form a special mindset. Its core is in flexibility and curiosity, which equips learners to respond to real-world challenges.

Bridge building competition is one of the annual events in Johore Matriculation College organized by Physics Unit which is an effort to expose student to STEM. This kind of competition offers knowledge application particularly on bridge structure and collaborative experience which helps student to broaden the impact of STEM education. Working in team to design and build the bridge would determine the successful of the bridge construction. This study aims to produce a durable bridge tester with highly accuracy to improve the testing and evaluation procedure in the competition.

Material and method

Figure 1 below shows the innovation development of Bridgtest. The Bridgtest 2.0 is the improved version and final product of our innovation. Bridgtest was firstly used for bridge competition in March 2021. The tester successfully tested the strongest bridge which could sustain the maximum load of 135 kg at failure. The tester is equipped with crane scale, steel cable with 3 mm thickness and hand winched. The frame of the tester is made of thick metal which is strong and durable. The top part of the tester is designed as the test platform for the bridge with more than 62 cm in length. Crane scale is used to enables user to accurately record the maximum load held by the bridge. The use of steel cable and hand winched ease the user to add load easily and uniformly to the bridge which is up to 300 kg.

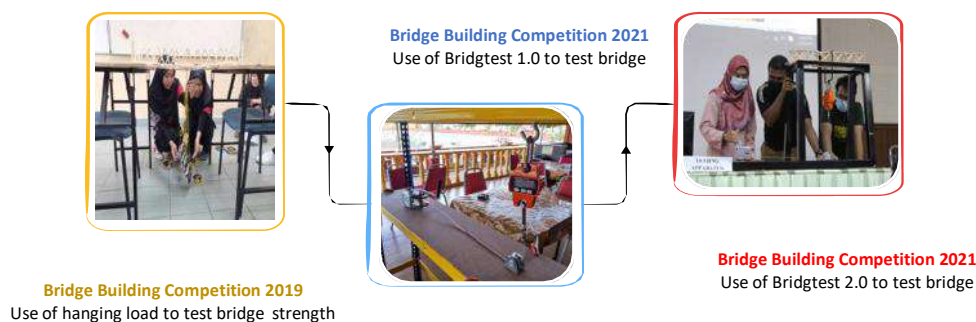

Figure 1: Innovation development of Bridgtest

The research methodology used was product test-run and survey to collect information about perception of users towards the Bridgtest. A set of questionnaires was then randomly distributed to 100 respondents who were the participants of the competition in order to gain information about Bridgtest usability, value and user's satisfaction.

Result and discussion

Impact of Bridgtest innovation

As the result of the innovation, it gives some good impacts to both organizer and participants of the competition. Below is the list of the impacts:

- i) strong and durable – Bridgtest is able to test the maximum load sustained by the bridge at failure up to 135 kg.
- ii) time saving – The use of the hand winched to add the load to the bridge has reduced the 50% testing time. Each group will only take 1.5 minutes to test their bridge in comparison to 3 minutes of using conventional tester.
- iii) Low cost - The tester only costs RM 323.34. This tester is much more cheaper comparing to other bridge tester that already on the market which cost more than RM3000. 90% of manufacturing cost has been reduced. It is also easy to maintain which only needs grease oil.
- iv) Easy to carry -The size of the Bridgtest is not too large and easier to carry during the competition. The tester does not need a large amount of weight or sand to test the strength of the bridge

User's feedback

Table 1 shows the three-point Likert scale that was used in the survey.

Table 1: Three- point Likert Scale

Mean Score	Level	Interpretation for Mean Range
1.00 - 2.33	Disagree	Low need
2.34 - 3.67	Moderately Agree	Moderate need
3.68 - 5.00	Agree	High need

Reference: (Jamil & Muktar, 2004)

Figure 2 shows the comparison between the mean score of conventional tester and Bridgtest. It is found that the participants were highly satisfied with the innovation as it gives many good impacts in term of its usability and value. It can be seen from Figure 2 that most items show highest mean score for Bridgtest in comparison with conventional tester.

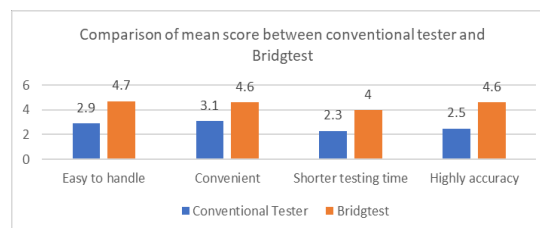

Figure 2: Comparison of mean score between conventional tester and Bridgtest

Conclusion

In conclusion, bridge testing apparatus was successfully developed which meet user's satisfaction and needs. It is a durable tester with highly accuracy to test bridge strength and low manufacturing cost. Bridgtest has a high potential to be commercialized as a tester equipment to all levels of education included primary school, secondary school, college and also university. The improvement will be continuously made so that the tester is relevant to use for many more purposes.

References

- Jamil, R. B., Muktar, S. N., 2004, Level of Awareness of Utm Staff on Occupational.
- Shahali, E. H. M., Ismail, I., & Halim, L. (2017). STEM education in Malaysia: Policy, trajectories and initiatives. *Asian Research Policy*, 8(2), 122-133.

COCONUT FIBRE GRINDING MACHINE

Mariam Binti Abdul Aziz

Kolej Kemahiran MARA Pasir Mas, Malaysia
mariam.aziz@mara.gov.my

Wan Muhammad Azim Bin Wan Makhzan, Siti Nor Syamimi Binti Abd Razak

Kolej Kemahiran Tinggi MARA Pasir Mas, Malaysia
wanazim903@gmail.com, ssyamimi304@gmail.com

Highlights: Coconuts are Malaysia's fourth largest industrial crop behind oil palm, rubber and rice. The coconut tree can be said to be a thousand purpose tree because each part has a specific use. Usually the processed coconut fibre or also known coco peat is used in the agricultural sector, especially because of its water-absorbing properties.

Key words: *Coconut, fiber, coco peat, grinding machine, agricultural*

Introduction

In agriculture sector, utilization of cocopeat as solid fertilizer has an important role in the fertility of the growing medium. Cocopeat is also used as a plant medium especially in fertigation systems. However, most of the cocopeats are commonly imported from other countries such as India or Indonesia. Since coconut is among largest industry crop in Malaysia, therefore it is important to process coconut fibre into valuable cocopeat.

Content

There are few methods of producing cocopeat from coconut fiber, mechanically using two separate machines, namely the fiber crusher and the cocopeat separation machine. Thus, to simply the process a coconut fibre grinding machine was invented to reduce time of cocopeat processing and increase the production. This machine is suitable for small and medium scale entrepreneurs related to coconut industry in our country.

Development of coconut fibre grinding machine started with identifying user requirements. A new machine is proposed by a few sketching and the best one is selected. The proposal then, was transformed into a product design using Inventor software. The next stage is product fabrication and testing. Some modifications have been done to improve the machine.

Finally, the machine testing was successfully achieved the objective of this project, which is to grind the coconut fiber for coco peat making. Hopefully, this machine will generate more income to coconut entrepreneurs and help them to process the coconut fiber easily.

Use of product

This machine able to grind coconut fibre in a short time. These fine fibres are used to produce coco peat. It is widely use in agriculture as a plant medium.



Figure 1: Coconut Fibre before grinding



Figure 2: Coconut fibre after grinding

Product Fabrication

- Process of joining the machine structure and body part.
- Process of part assembly according to drawing



Figure 3

- **Finishing process**



Figure 4

- **Testing and modification**

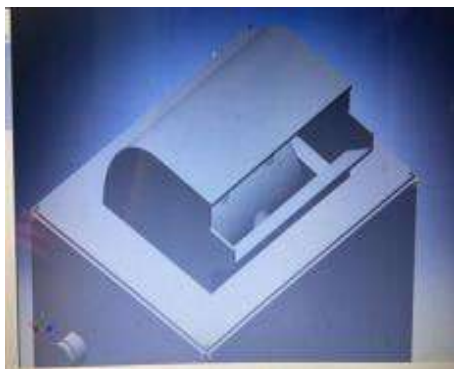

Figure 5

- **Finished product**



Figure 6

Advantage of the product towards community

The advantages of this machine are:

- reduce time to grind the coconut fibre and to process coco peat
- easier to grind the coconut fibre compare to other method
- able to generate more income to coconut entrepreneur since the coco peat is valuable in agriculture industry.

References

Tan Zhai Yun (2019). Agriculture: A coconut revival. Publish in Enterprise, The Edge Malaysia Weekly, on 8 April, 2019

Then Kek Hoe (2018). The current Scenario and development of coconut industry. The Planter, Kuala Lumpur:94(1108) page 413-426

Murugesan V.Krishnapillai, Steven Young-Uhk, James B.Friday and Diane L.Haase (2020). Locally Produced cocopeat growing media for container plant production. Tree Planters Note: Volume 63 (page 29-38)

DEVELOPMENT OF REALTIME MONITORING SYSTEM FOR WELDING PARAMETER MONITORING (seeWeld)

Sarizam Mamat

Universiti Malaysia Kelantan, Jeli Campus, 17600 Jeli, Kelantan
sarizam@umk.edu.my

Ahmad Zaki Amiruddin, Khairul Nizar Syazwan Wan Salihin Wong, Azfi Zaidi Mohammad Sofi@Aziz, Airel Jashimiey Arifin, Rose Ellyana Alifah Roslan

Universiti Malaysia Kelantan, Jeli Campus, 17600 Jeli, Kelantan
ahmadzaki@umk.edu.my, nizar.w@umk.edu.my, azfi.ms@umk.edu.my, ea.jashimiey@gmail.com, fellyanarose@yahoo.com

Highlights: The develop device and ant apps is mainly to help the supervisors to monitor the welder's performance, beneficial to prepare a data for PQR during WPS establishment and help student to understand properly the relationship of the welding parameter with the weldment quality (Meseguer-Valdenebro, Portolés, Meseguer-Valdenebro, Portoles, & Martínez-Conesa, 2017).

Key words: Welding parameter, transmitter, current, voltage, apps development

Introduction

Nowadays, visualization is a way in understanding a problem faced during any operation/manufacturing process. In welding, visualize a parameter during welding process is a key point to control the quality of the weldments, as well as to monitor the performance of the welder. "seeWeld" is a result of demanding technology in this IR 4.0 era. This monitoring apps will help supervisor to monitor his welder performance at all time. At the same time, this will reduce the time during preparation of Welding Procedure Standard (WPS) since this apps can eliminate the needs of complicated Welding Procedure Qualification Records (wPQR) because all of the data during welding will be save in database (Ellyana Roslan et al., 2020). Refer figure below for the proposed system.

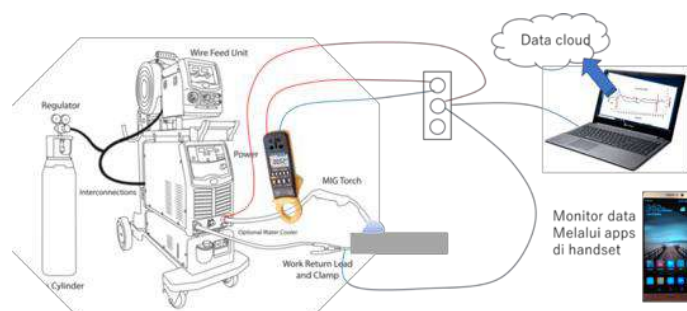

Figure 1: Proposed system for real-time welding parameter monitoring system

Content

1. Development of device (current sensor and transmitter) detect the output welding current and voltage and transmit it as data cloud
2. Develop an apps to realtime monitor the welding current and voltage.
3. Monitoring of the welding current and voltage during welding can benefit:
 - a) supervisors in monitoring the welder's performance,
 - b) ease the company in preparing a PQR during establishment of WPS (PQR : Procedure Qualification Record, WPS : Welding Procedure Standard)
 - c) help student to weld properly with adherence to the welding standard.

References

- Ellyana Roslan, R. A., Mamat, S., Teo, P. Ter, Mohamad, F., Gudur, S., Toshifumi, Y., ...Tanaka, M. (2020). Observation of Arc Behaviour in TIG/MIG Hybrid Welding Process. In *IOP Conference Series: Earth and Environmental Science*. <https://doi.org/10.1088/1755-1315/596/1/012025>
- Meseguer-Valdenebro, J. L., Portolés, A., Meseguer-Valdenebro, J. L., Portoles, A., & Martínez-Conesa, E. (2017). Teaching of ASME IX code to students of GTAW, GMAW/FCAW, SMAW and SAW welding processes. *Journal of Materials Education*.

HANDS FREE HAND SANITIZER

Sheilani Binti Shaari

Politeknik Kota Bharu, Kota Bharu, Malaysia
sheilani@pkb.edu.my

Nur Alia Izatey Binti Ismail

Politeknik Kota Bharu, Kota Bharu, Malaysia
harukimishakichan01@gmail.com

Highlights: Malaysia is now not only facing an explosion of new daily cases of COVID19 but also has to deal with a more violent variant of the coronavirus and capable of triggering higher rates of infection and death. The Ministry of Health Malaysia recommends practices that need to be practiced such as frequent hand washing with soap and water (Wash), wearing a half face mask, nose and mouth cover (face mask) in public or if symptomatic (Wear), and avoid shaking hands / contact to ensure that the chain of COVID19 infection can be broken (Warn). The World Health Organization (WHO) describes it as more important to maintain hygiene and prevent the spread of the COVID19 threat germs through surfaces. The results of observations have been made around Kok Lanas, Kelantan such as at Kota Bharu Polytechnic, Econjaya Supermarket, Syarikat Muda Osman, Kedai Setia RM2.20 and grocery stores. It is found that all these premises provide hand sanitizer or disinfectant at the entrances for the use of customers. The problem is customers have to press the handle of the bottle, hand sanitizer and dispenser to use the hand sanitizer or disinfectant. This is the most susceptible surface to germs and can serve as a vector of infectious disease transmission. This hands-freehand sanitizer project is controlled using an Arduino UNO. The ultrasonic distance detector works to detect the hand. The servo motor rotates to press the disinfectant handwashing bottle. The Liquid Crystal Display (LCD) works to display the words USE ME and THANK YOU. The sanitizer will be dispensed as soon as the hand is detected within 10 cm of the ultrasonic detector. The project operates using a 5v power supply and is charged using solar energy. The project can be adapted to other hands-free uses such as soap bottles, seasoning dispensers in restaurants and others. In the future, this project can be further improved by adding IoT (Internet of Things) functionality by controlling to turn on and off the circuit as well as obtain data on the frequency of use of this tool on a daily basis.

Key words: *hand sanitizer, arduino UNO and solar.*

Introduction

In December 2019, the world was shocked by news of a novel coronavirus being identified in China. According to the latest COVID19 statistics released by Worldometer, the status of COVID19 cases on 29 July 2021 is 196,710,185 cases with a total of 4,203,695 deaths. The World Health Organization (WHO) has declared the condition an epidemic and has suggested that maintaining hygiene is one of the measures to prevent the spread of the COVID19 pandemic. This situation has influenced the high demand for disinfectant liquids as a measure of hand hygiene.

Content

A student from Mara University of Technology, Najihah Abd Latif has created a product called "STEPBACK GERM". The resulting product simply needs to press the pedal of the disinfectant liquid bottle with the foot instead of by hand. By referring to the project video from YouTube, entitled Automatic Hand Sanitizer Dispenser using Arduino which was produced by Technical Romboz on Aug 22, 2020. The video has explained about the ways to produce Automatic hand sanitizer project using Arduino UNO. This project is said to be very useful and safe to use during COVID 19. Meanwhile, TATEX Mechatronics have produced a product called the Foam Hand Sanitizer Automatic Dispenser Motion Sensor which can detect hand movements using a motion sensor and it has the option of using either an AA battery or an AC/DC adapter as a power supply source.

From the observations that have been done around Kok Lanas such as at Kota Bharu Polytechnic, Econjaya Supermarket, Kedai Setia RM2, Syarikat Muda Osman bookstore and several grocery stores. It was found that most of the disinfectant liquid provided was only placed on the table or hung on the wall. This does not guarantee the customer will be germ-free where the customer will have to press the bottle or open the cap of the disinfectant liquid bottle when using it.

To overcome the problems that have been observed, this project has 3 objectives to be achieved. The objectives are to produce a project circuit that can:

1. Detect hand movements to drive servo motors,
2. Control all circuits using an Arduino UNO and
3. Charge batteries using solar energy

The project will only detect hands using an ultrasonic sensor that will detect hands as far as 10cm. The LED will illuminate when a hand is detected. The servo motor will rotate by 180 degrees and the LCD will display the word "TERIMA KASIH" after the servo rotates and when no object is detected while will display "GUNA SAYA". The power supply is 5v and will be charged using solar energy.

This project uses Ultrasonic HC RS04 sensor, servo motor, and 16x4 i2C LCD. This circuit operates when the TRIGGER on the HCSR04 ultrasonic sensor connected to PIN4 arduino uno emits a signal if there is an object in front, the signal will be reflected back and received by the ECHO connected to pin8 which will be converted to distance. If the distance detected is in the range of 10cm. The LED will light up. Meanwhile, the signal from the ultrasonic sensor will be sent to the servo motor connected on pin 2. The signal received by the servo motor will be translated into an analog electrical signal. The motor will rotate and will rotate the potentiometer and give position feedback to the servo. The servo will rotate until the output shaft meets 180 degrees. The LCD will get the signal through pin 4 and pin 5 on the Arduino. The LCD will display the words "GUNA SAYA" while the servo motor is rotating and "TERIMA KASIH" after the servo stops rotating. The "FREE SANITIZER" display will be displayed at all times.

Project testing was done by simulation using proteus and real equipment. The test results are as recorded in Table 1. The table shows that when the ultrasonic detector detects a hand within 10cm, the LED will turn on, the servo motor will rotate while the LCD will display the words "GUNA SAYA" as soon as the hand is detected and "TERIMA KASIH" after the servo rotates. Words "FREE SANITIZER" will be displayed all the times. By referring the result in Table 1 also, this project has succeeded in achieving all three set of the objectives.

Table 1: Test Result

Test	Ultrasonic Sensor	LED	Servo Motor	LCD
Simulation	0	Off	Stop	"FREE SANITIZER" "GUNA SAYA"
	1	On	Turn 180°	"TERIMA KASIH" "FREE SANITIZER"
Real Equipment's	0	Of	Stop	"FREE SANITIZER" "GUNA SAYA"
	1	On	Turn 180°	"TERIMA KASIH" "FREE SANITIZER"

As a conclusion, the result shows that this project is able to detect hand movements by using ultrasonic sensors. So, users can feel safe to use the sanitizer without any worry of touching or pressing the bottle using their hands or feet. The project can also be controlled using an Arduino UNO and the power supply can be charged using solar energy. This method can save electricity consumption and is environmentally friendly.

The project can be adapted to other hands-free uses such as soap bottles, seasoning dispensers in restaurants and others. In the future, this project can be further improved by adding IoT (Internet of Things) functionality by controlling to turn on and off the circuit as well as obtain data on the frequency of use of this tool on a daily basis.

Acknowledgement

Thanks be to Allah SWT for the strength that has been given to us in finishing this project. We would also like to take this opportunity to thank Encik Nik Nor Hishamuddin bin Nik Mustapha and Encik Noor Hisham bin Koya for contributing their thoughts and time directly and indirectly in preparing this project. Not forgetting also to Encik Ismail bin Jusoh and his family for the understanding and a lot of moral support to their daughter in preparing this project.

References

- Arduino_uno_guy. (2019, November 13). I2C Liquid Crystal Displays . Retrieved from Project Hub: https://create.arduino.cc/projecthub/arduino_uno_guy/i2c-liquid-crystal-displays-5b806c
- Grant. (2016, February 14). How to use a Servo . Retrieved from PROJECT HUB: https://create.arduino.cc/projecthub/trduunze/servo-84087a?ref=search&ref_id=servo%20motor&offset=3
- Latif, N. A. (1 July 2020). Stepback Germ. Universiti Teknologi Mara.
- Malaysia, K. K. (2021, May 28). Langkah-Langkah Pencegahan Penularan COVID-19 di Tempat Kerja. Retrieved from Covid19 Malaysia: <https://covid-19.moh.gov.my/semasa-kkm/2021/05/langkah-pencegahan-covid-19-di-tmpt-kerja>
- Pendergast, R. L. (2013, November 17). Complete Guide for Ultrasonic Sensor HC-SR04 with Arduino. Retrieved from randomnerdtutorials: <https://randomnerdtutorials.com/complete-guide-for-ultrasonic-sensor-hc-sr04/>
- Romboz, T. (2020, August 22). Automatic hand sanitizer dispenser using Arduino. Retrieved from <https://www.youtube.com/watch?v=sxqBbkhozY>

CNC MACHINE MOTION CONTROL TECHNIQUE FOR ISO 14649 DATA INTERFACE MODEL

Kamran Latif

Universiti Teknikal Malaysia Melaka (UTeM), Melaka, Malaysia
kamran@utem.edu.my,

Shafinaz Ismail, Muhammad Hazimi Hilmi Md Puzi, Hamdan Syakirin Md Amir, Krisnan Kandhian

Universiti Teknikal Malaysia Melaka (UTeM), Melaka, Malaysia
shafinaz.ismail@gmail.com, b091810095@student.utem.edu.my, b091810064@student.utem.edu.my,
b091810005@student.utem.edu.my

Highlights: This study introduces a new generation of CNC systems based on Open Architecture Control (OAC), virtual component technology, and the STEP-NC data interface model. Modern computer numerical control (CNC) systems are more adaptable, interoperable, open, and intelligent. In order to facilitate the implementation of such a CNC system, an ISO standard known as STEP for numeric control (STEP-NC) or ISO 14649 was created in 2004 to address several issues with the commonly used CNC standard (ISO 6983) (Latif, Adam, Yusof, & Kadir, 2021).

Key words: Smart CNC System, STEP-NC, Open Architecture Control, Virtual Component Technology

Introduction

An indirect STEP-NC programming methodology was used to implement STEP-NC on several commercial CNC systems at first. Due to the vendor-specific and machine tool-dependent translation of data from the highest level to the low level, this technique failed to meet all of the needs of a modern CNC system. Therefore, interpreted STEP-NC concepts arose to tackle these difficulties (Rauch, Laguionie, Hascoet, & Suh, 2012). This study introduces a new generation of CNC systems based on Open Architecture Control (OAC), virtual component technology, and the STEP-NC data interface model. The overall architecture of the developed system is shown in Figure 1. The created system employs a new set of techniques for STEP-NC data interpretation, visual verification, machine motion control, monitoring, and report creation modules. The STEP-NC interpretation technique is based on (Yusof & Latif, 2015) that has been upgraded with new data extraction and tool path algorithms. This module extracts data from the ISO 14649 data interface model and creates tool pathways. Before actual machining, the generated tool paths are verified using the visual graphics module. The machine motion control module is based on (Latif, Yusof, Nassehi, & Alias Imran Latif, 2017) method that has been upgraded with low-cost microcontroller hardware. This module is responsible to execute the interpreted data for actual machining. Simultaneously, the monitoring and report generation modules monitor machining operations in real-time and generate a job report in a user-defined format. These new integrations have enhanced the system accuracy and reduced the adoption cost. The industry and education sectors can use it for the development of smart CNC systems.

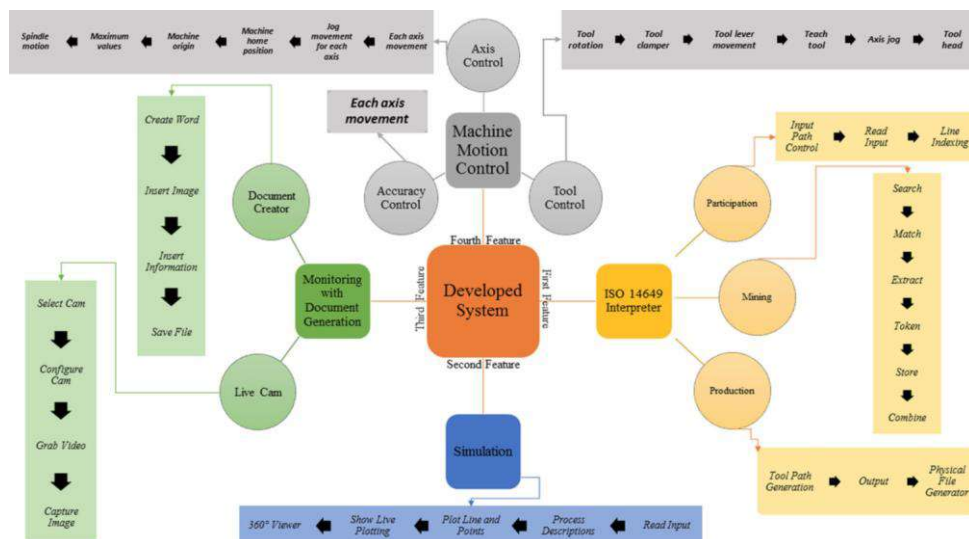

Figure 1: Architecture of Developed System

Acknowledgment

This work is supported by the Ministry of Higher Education (MoHE) Malaysia under the Prototype Research Grant Scheme (PRGS) number PRGS/2020/FTKMP-COSSID/T00026. The authors would like to thank the Sustainable and Responsive Manufacturing (SUSREM) research group, and the Center of Research and Innovation Management (CRIM) of Universiti Teknikal Melaka (UTeM). The authors also acknowledge the support of the Advanced Manufacturing and Material Centre (AMMC) of Universiti Tun Hussein Onn Malaysia (UTHM), and Production Laboratory of Universiti Teknologi Malaysia (UTM).

References

- Latif, K., Adam, A., Yusof, Y., & Kadir, A. Z. A. (2021, June 1). A review of G code, STEP, STEP-NC, and open architecture control technologies based embedded CNC systems. *International Journal of Advanced Manufacturing Technology*, Vol. 114, pp. 2549–2566. <https://doi.org/10.1007/s00170-021-06741-z>
- Latif, K., Yusof, Y., Nassehi, A., & Alias Imran Latif, Q. B. (2017). Development of a feature-based open soft-CNC system. *The International Journal of Advanced Manufacturing Technology*, 89(1–4), 1013–1024. <https://doi.org/10.1007/s00170-016-9124-0>
- Rauch, M., Laguionie, R., Hascoet, J.-Y., & Suh, S.-H. (2012). An advanced STEP-NC controller for intelligent machining processes. *Robotics and Computer-Integrated Manufacturing*, 28(3), 375–384. <https://doi.org/10.1016/j.rcim.2011.11.001>
- Yusof, Y., & Latif, K. (2015). New technique for the interpretation of ISO 14649 and 6983 based on open CNC technology. *International Journal of Computer Integrated Manufacturing*, 1–13. <https://doi.org/10.1080/0951192X.2015.1030698>

LANDSLIDE SUSCEPTIBILITY MAPPING USING THE GEOGRAPHIC INFORMATION SYSTEM (GIS) APPROACH

Rohazaini Muhammad Jamil

Faculty of Earth Science, Universiti Malaysia Kelantan Kampus Jeli, Kelantan, Malaysia
rohazaini@umk.edu.my

**Noorzamzarina Sulaiman¹, Nursufiah Sulaiman¹, Siti Aisyah Nawawi¹, Amal Najihah Mohamad Nor¹,
Norfadhilah Ibrahim²**

¹Faculty of Earth Science, Universiti Malaysia Kelantan Kampus Jeli, Kelantan, Malaysia

²Faculty Of Bioengineering and Technology, Universiti Malaysia Kelantan Kampus Jeli, Kelantan, Malaysia
zamzarina@umk.edu.my, nursufiah@umk.edu.my, aisyah.n@umk.edu.my,
amalnajihah@umk.edu.my, nfadhilah@umk.edu.my

Highlights: The purpose of this study is to generate a landslide susceptibility map using GIS approach (Analytical Hierarchy Process (AHP) method) at Temangan, Machang District in Kelantan. This study area was located at Temangan, Machang that covers an area of 25 km². Seven (7) parameters that triggered the occurrence of landslide were determined such as lithology, aspect, landuse, slope, distance to road, distance to fault and distance to stream. The result of landslide susceptibility map shows three (3) susceptibility classes, low, moderate, and high). The higher the class value, the higher the landslide susceptibility whereas lower value means a lower susceptibility of landslide. Based on the result of Landslide Susceptibility Map, it can conclude that the study area consist of low susceptibility percentage and the probability to landslide occurrence is low.

Key words: *landslide susceptibility, GIS, AHP method*

Introduction

Landslide is a natural disaster. Worldwide, landslides cause billions of dollars in damage every year and thousands of deaths and injuries. Landslide is the rock, earth (soil) mass movement down a hillside under gravitational influence (Akter et al., 2019). The landslide susceptibility mapping can be created by using the Analytical Hierarchy Process (AHP) including Spatial Multi-Criteria Evaluation (SMCE) and Weighted Linear Combination (WLC) introduced by Saaty 2001. The subjective assessment of the experts can be reduced by generating an objective mapping of the susceptibility to landslide by using the stated approach. Thus, this study is intended to apply AHP method that is embedded within Geographical Information System (GIS) environment to produce a landslide susceptibility map at Temangan, in Machang district, Kelantan. A GIS overlay method and raster calculation approach were applied in order to generate the landslide susceptibility map.

Content

In this study, a GIS-based AHP was used to map the landslide susceptibility in Temangan Machang district, Kelantan. The overall estimation of landslide susceptibility for an area results from the combination of susceptible levels of the seven (7) individual parameters.

From the result, three classes consist of very low, low, moderate/medium, high and very high can be seen on the landslide susceptibility index map (Figure 1). The higher the index, the more prone the region is to landslide event.

It can be observed that almost half of the study area region (53%) falls into low susceptibility to landslide area, meanwhile, 35 % of the study area is suspected to be in moderate susceptibility to landslide. Only 12% of the study area is considered highly susceptible to landslide. Thus, this study suggested that this area is low to moderate risk towards future landslide event.

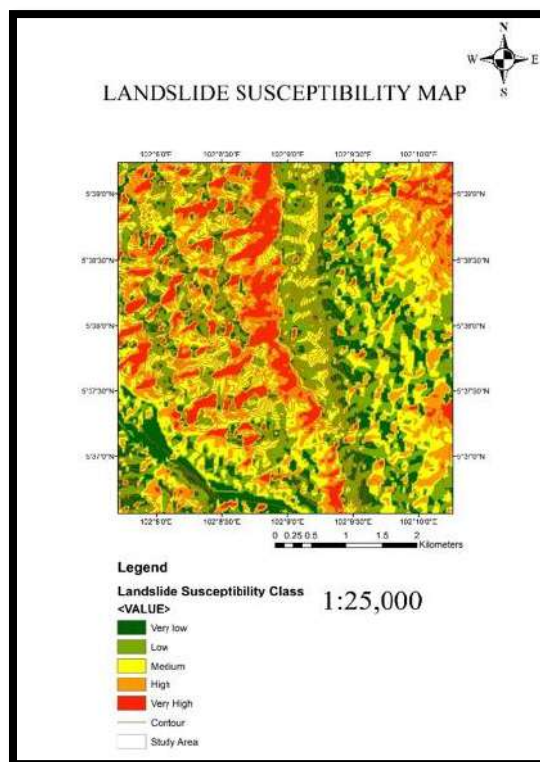

Figure 1: Landslide susceptibility index map

The susceptibility of a given area to landslides can be determined and depicted using hazard zonation. A landslide hazard map can be prepared early in the planning study and developed in more detail as the study progresses. It can be used as a tool to help identify land areas best suited for development by examining the potential risk of landsliding. Furthermore, once landslide susceptibility is identified, investment projects can be developed which avoid, prevent, or substantially mitigate the hazard. In developing areas with landslide hazards, mitigation measures should be selected if they are not already part of the project identification information. It is possible to reduce the possible impact of natural landslide activity and limit landslides which occur as a result of human activity. Landslide hazards resulting from development can be reduced by designing changes to counteract the impact that development may have on slope integrity. This might take the form of permitting only warehouses and storage facilities in higher hazard areas, to reduce the vulnerability to the population should a landslide occur.

Acknowledgement

This work was supported by Faculty of Earth Science, Universiti Malaysia Kelantan Jeli Campus.

References

- Akter, J.M.M. Noor, M. Goto, S. Khanam, A. Parvez, and M. Rasheduzzaman. (2019) Landslide Disaster in Malaysia: An Overview in International Journal of Innovative Research and Development 8(6), India, pp 292–302.
- Saaty T.L. (2001). The seven pillars of the analytic hierarchy process. In: Multiple Criteria Decision Making in the New Millennium, Berlin, Heidelberg: Springer, pp 15–37.

SMART SOLAR GRASS CUTTER

Mohd Hisham Bin Makhtar

Politeknik Kota Bharu, Kok Lanas, Kelantan
Mhisham7174@gmail.com

**Wan Muhammad Marzudi Bin Wan Muhammad; Muhammad Rozidie Bin Sazali; Muhammad Amyrul
Aizat Bin Mohd Asri; Ahmad Fahmi Bin Mohamed**

Politeknik Kota Bharu, Kok Lanas, Kelantan
marzudi@pkb.edu.my; rozidies@yahoo.com; amirul.aizat1660@gmail.com; fahmimohd2712@gmail.com

Highlights: From the time immemorial, the sun is the major source of energy for life on earth used for heat and lighting. Nowadays, solar energy has been known as a renewable energy source. It is an alternative energy to that of fossil fuel and it can be collected from renewable resources such as sun, wind and hydro. This paper introduces a new development of grass cutter, named as Smart Solar Grass Cutter, by using solar irradiance as primary energy source with the presence of a solar panel. This grass cutter prototype is developed to reduce air pollutants and improve the current design, specifically the blade position based on the previous studies. With current technology, this new prototype is designed as a remotely controlled grass cutter. After developing an established prototype, the design analysis is carried out to validate with the theoretical values to ensure that the prototype can be safely used. The Smart Solar Grass Cutter can operate more than two hours when the used battery is fully charged. Based upon the results, the Smart Solar Grass Cutter is reliable with high efficiency of the system compared to the previous studies. Therefore, it can be concluded that the prototype is reliable and environmentally friendly.

Key words: *Smart Grass Cutter, Solar Grass Cutter, Smart Solar System, Solar Panel, Blade, Battery*

Introduction

The conventional grass cutters have been widely used recently by workers in the gardening and agricultural industries. However, the manually handled grass cutters are consuming a lot of energy and producing air pollution which can directly affect the workers' health. The conventional grass cutters are also creating a high level of noise and vibration which can cause serious health issues such as grip strength, decreased hand sensation and dexterity, finger blanching or 'white fingers' and carpal tunnel. In order to address these issues, a new design of a grass cutter machine has been proposed. This device can be fueled by solar energy and smartly controlled, which has been named as a Smart Solar Grass Cutter that has three main systems which are remote control system, solar system, and the grass cutter.

Technology is helping the human being to work less, however receiving more outputs, save their time, ease their work. Humans can take the advantages of current technologies to improve life quality as well as reduce the negative effects of the new technologies on the planet Earth. In this study, solar energy was used as a main power source to the proposed solar grass cutter. The proposed grass cutter combined the use of automation and manual in which it used sensors or remote controllers to move. This proposed study is mainly to improve the current grass cutter design especially the position of the blade using the latest possible technologies.

This design is meant to be an alternate green option to the popular and environmentally hazardous fuel powered lawn mower. Ultimately, the consumer will be doing more for the environment while doing less work in their daily lives. The hope is to keep working on this project until a suitable design can be implemented and then be ultimately placed on the market.

Description of Design

To design a Smart Solar Grass Cutter, some parameters need to be considered such as the components to be used in the project, the position of the components, the structure of the main body, the advantages and disadvantages of the design and the safety factors. The Smart Solar Grass Cutter is able to operate autonomously or non-autonomously. Other than that, the important factor is efficiency. The materials and components selections including the positions are crucial to achieve a better efficiency.

This Smart Solar Grass Cutter is a simple design which is optimizing the usage of materials. The overall dimensions are depending on the size or the dimensions of the solar panel. Three motors are used for rear tires and the blade. The height of the roof depends on the height of the battery. The rubber rotating wheel is used as the front tires as it will automatically change the direction depending on the rear tires. One motor is implemented for each rear tire. The design is cost effective and compatible with the main objectives. Starting from the hand sketch, the prototype is designed in multidimensional using SolidWorks software. Dimensions of the design are very important and need to be accurate and precise to enhance the safety factor.

Background

Today the most promising source of energy where everyone focusing is the concept of Solar Power and its Utilization. Generally, we see people who had gardens use lawn mowers manually to cut the unwanted grass. Those lawn mowers are powered from normal household's power through cables or using petrol/diesel. Using cables creates messing problem and if there is any power cut, we can't use that lawn mower. Similarly, if we use petrol/diesel powered machine, it requires money and they create pollution through the smoke. Through this project, we are going to build Smartz Solar Grass Cutter which is powered by solar energy and it will overcome all the above-mentioned problems.



Advantages

First of all, we find that the existing lawn machines are very dangerous to society. Therefore, we have designed a solar-powered lawn machine to reduce the risk to consumers as well as people around. This machine does not emit any smoke as it does not use fuel such as petrol. Hence, we can adopt the concept of the environment. In addition, we have also added iron barriers around the cutting eye so as to prevent foreign objects such as stones from being exposed to the users as well as the people around.

Commercial

1. Market research to ensure the idea is a viable one.
2. Initial testing and trialling.
3. Further testing, including market testing.
4. Development of a marketing plan.
5. Marketing the product.

Table 1: Material, Quantity and Specialty

Material	Quantity	Speciality
Solar Panel	1	Supplying Solar Energy
Grass Cutter Blade	1	Stainless
Barrier Plate	1	Safety Features
Remote Control	1	To Control The Machine

Acknowledgement

Mr. Mohd Hisham Bin Makhtar, our supervisor, encouraged us to carry this work. He continues giving invaluable knowledgeable guidance throughout the course if this study helped us to complete the work up to this stage and hope will continue in further research.

References

- G.Rahul, "Grass cutting machine by solar energy power", ISSN no:2348-4845,international journal and magazine of engineering, technology management and research.
- M. J. S. Asha N, Saraswathi R, Rahul R, Ravikiran, "Smart Grass Cutter," Perspectives in Communication, Embedded-Systems and Signal Processing (PiCES), vol. 1, no. 6, 2017, doi: <http://www.picesjournal.com/ojs/index.php/pices/article/view/31/22>.
- Ms.Yogita D. Ambekar, Mr. Abhishek U. Ghatge, "Solar based grass cutter", ISBN:978-93-86171-31-3, 26 Feb 2017, International conference on recent trends in engineering, science, Humanities and management.

OBIA: MAPPING FOREST MADE EASY!

Noor Janatun Naim Jemali

Faculty of Earth Science, Universiti Malaysia Kelantan
janatunnaim@umk.edu.my

Mohd Fariz Abd Rhani¹, Syafinie Majid², Marinah Muhammad²

¹Forestry Department Peninsular Malaysia,

²Faculty of Earth Science, Universiti Malaysia Kelantan

fariz@forestry.gov.my, syafinie.am@umk.edu.my, marinah@umk.edu.my

Highlights: Using traditional pixel-based classification algorithms to categorise high-resolution remote sensing data is inefficient for developing high-accuracy land-cover maps, particularly in spectrally diverse and complex land area. Here we present an object-based approach that mapped a small forest area by creation of image objects that meet the attributes selection requirements. 'Think object, not pixel' is the main principle of OBIA. The Object-based image analysis using eCognition software was found very practical and easy in classifying and mapping an area. OBIA reduced computation intensity in segmentation process by creating hierarchical image object network to aid-in picture object delineation at various spatial scales together with expert knowledge of spectral, contextual, and geometrical features to establish the algorithm rule set. In turn, analysis using OBIA has more information classes and greater accuracy than that derived with pixel-based classification methods.

Key words: *e-Cognition, segmentation, forest cover, tree count, crown cover*

Introduction

Remote sensing technology's capabilities are well known across the world, especially in forestry operations. This is a useful tool for assessing forest environmental features, primarily in forest monitoring, spatial planning, conservation, and urban forest development (Batz & Schape, 2000). OBIA, the object-based image analysis is a method to recognize an image from its meaningful object and their mutual relationship. OBIA takes into account an image's spectrum, form or shape, size, texture, and context of the image for segmentation process. Homogenous image object was extracted within the desired resolution on different scale parameters. Hierarchical network of image object was created where upper level image segments represent a small scale object and vice versa (Batz et al., 2015).

Based on image objects, problems of multisource data fusion is tackled by enabling parallel evaluation of image information of arbitrary source. Three factors were used in segmentation to suit image with real world data namely 1) scale parameter, 2) color or shape and 3) smoothness and compactness. Segmentation phase is followed by classification process by means to classified segmented object with their physical properties. In eCognition, there are two basic classifiers act as class descriptor called nearest neighbor and fuzzy membership. Before image was classified with Nearest-neighbor algorithm several levels of segmentation with different scale parameters developed by [3].

While pixel-based methods solely evaluate spectral reflectance, the OBIA method employs several segmentation algorithms to enhance classification accuracy (Blaschke, 2019; Zawawi et al., 2015; Shiba & Itaya, 2011). Therefore, this approach has been examined to be used in classifying and mapping the selected forest area in this project.

Objective

The objective of this project is to evaluate the effectiveness of OBIA in mapping a small part of logged over forest and vegetation recovery of post-harvest activity through remote sensing analysis technique.

Project Description

Many advance techniques can be applied in analyzing remote sensing images such as by pixel, object or both. Using OBIA, the mapping of an area become easier provided with the best define rule set by user. 'Think object, not pixel' is the main principle of OBIA. Two processes in OBIA analysis are segmentation and classification.

- **Segmentation: Break the image up into objects representing land-based features.**
- **Classification: Classify those objects using their shape, size, spatial and spectral properties.**

Segmentation will generate meaningful objects where pixels were groups to form objects, similar to how our eyes process our surroundings. After segmenting the image, each object will be classified. Classification was based on statistics associated with them. For example, objects can be classified based on geometry, area, color, shape, texture, adjacency, and more. The hierarchical proses will take place and produced the most suitable classes of an object.

Example of OBIA in mapping a post-harvest area as shown below:

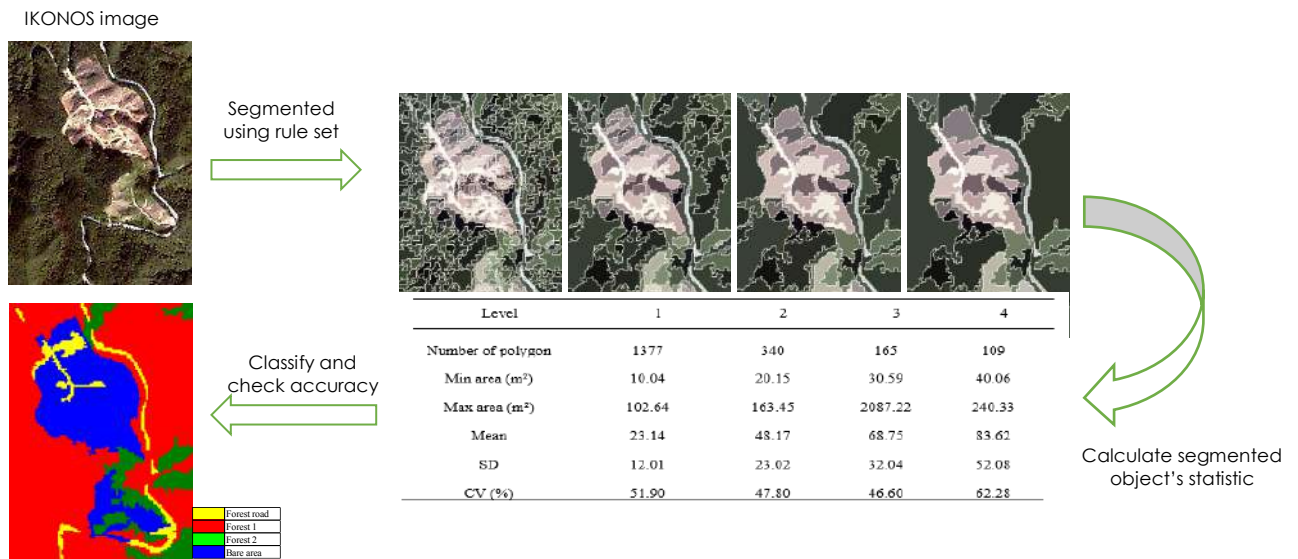

Figure 1. The example use of OBIA in mapping a post-harvest forest using IKONOS image as the base photo.

Advantage / Novelty

OBIA is about object detection and mass production. We create a ruleset, run it, and edit our classification as necessary.

The strength of OBIA are:

- No salt-and-pepper effect on image after classification
- Partitioning an image into items - analogous to how people cognitively arrange the landscape
- Image-objects as fundamental units - decreases computational classifier load by orders of magnitude while allowing the user to take use of more complicated approaches (e.g. non-parametric).
- Image-objects have valuable properties (such as form, texture, and context relationships with other things) that single pixels lack on.
- Unlike pixel-wise categorized raster maps, image-objects is more easily incorporated into vector GIS.
- Reduce complexity and work load

Commercial Value

OBIA provides increased accuracy and detail for classification purposes. Using OBIA, knowledge on a landscape may be included by introducing rules. When a group of trees, grass and water is found in the neighborhood of dense housing it is likely to belong to a city park. In contrast, a group of trees surrounded by many others probably belongs to a forest. It is possible to make this distinction with OBIA, but not using traditional spectral image analysis. OBIA can be applied not only for forestry image classification, it is also wise-use for urban, stand density, river analysis, landscape, land use and land cover mapping etc.

Acknowledgement

Involvement, assistance and support from individuals or groups either directly or indirectly were much appreciated.

References

- Baatz, M. And Schape, M. (2000) Multi Resolution Segmentation: An Optimum Approach For High Quality Multi Scale Image Segmentation. In Strobl T., Blaachke T., Laachke T., Griesebner G., (Eds): Beutrage Zum Agit-Symposium. Salzburg, Heidelberg, 12-23
- Baatz, M. Benz, U. Dehghani, S. Heynen, M. Holtje, A. Hofmann, P. Lingenfelder, I. Mimler, M. Sohlbach, M. Weber, M. And Willhauck, G. (2005) E-Cognition Elements User Guide 4. 71pp. Defineins Imaging Gmbh, Germany
- Bhaskaran, S. Paramananda, S. And Ramnarayan, M. (2010) Per-Pixel And Object-Oriented Classification Methods For Mapping Urban Features Using Ikonos Satellite Data. Applied Geography, 30(4): 650-665.
- Blaschke, T., (2009). Object-Based Image Analysis For Remote Sensing. Isprs Journal Of Photogrammetry And Remote Sensing.
- Shiba, M. And Itaya, A. (2011) Using An Object-Based Imagery Processing To Increase The Accuracy Of Delineating Spatial Forest Operational Unit From Ikonos Image And Dem Data Integration. Journal Of The Japanese Society Of Coastal Forest. 10(1): 21-25.
- Zawawi, A.A., Shiba, M., Jemali, N.J.N. (2015). Accuracy of LiDAR-based tree height estimation and crown recognition in a subtropical evergreen broad-leaved forest in Okinawa, Japan. Forest Systems, 2015, 24(1), e002

MOBILE PRECAST STUMP AND FOOTING

Mohd Yuzha Bin Usoff

Jabatan Kejuruteraan Awam, Politeknik Sultan Mizan Zainal Abidin, 23000 Dungun, Terengganu
 yuzhapsis@gmail.com

Hamidah Bt Zakaria, Mohd Hilmei Bin Abdul Azif, Izham Bin Wahab @ Hassan Basari

Jabatan Kejuruteraan Awam, Politeknik Sultan Mizan Zainal Abidin, 23000 Dungun, Terengganu
 miezakaria7678@gmail.com, hilmeistamping@gmail.com, izham@psmza.edu.my

Highlights: The Mobile Pre-cast footing and stump, it's an innovative sub-structure (Building foundation) component of the building that can transform a construction industry from a conventional method to an industrialized building system (IBS). Help the builders in terms of cost, time, quality and on-site manpower's quantity. The fabrication process is carried out in the factory or designated manufacturing place under controlled conditions using good quality materials and moulded using a long-lasting steel mould (steel formwork). When the units are prefabricated at controlled places using standardized material with long-lasting mould (steel formwork), it can optimize the quality, minimize the cost with time effectively and the manpower uses also reduced significantly. From a detailed on-site study, the results show this product is able to withstand the design load before being spread to the ground safely. This product respectively impacts small-scale construction. This product was successfully commercialized with strategic collaboration with PKPK member of companies (Noha Niaga Sdn Bhd). A medium-sized production plant was set up to manufacture this product since 2019.

Key words: IBS, Sub structure, Stump and Footing, steel formwork, PKPK

Introduction

The IBS (Industrialized Building System) method is one of the factors that can make the construction sector more viable. Unfortunately, most of the IBS components are made for a superstructure such as columns, beams, walls, and floor panels. Most of the IBS manufacturers also produce IBS components for large-scale construction such as hospitals, schools, apartments, and more high-rise buildings. However, we can find the superstructure IBS components for small buildings like houses, but the numbers of manufacturers are very low and limited to just several regions especially in the western peninsula of Malaysia. Besides, the building can't stand without a foundation or what we call a substructure. In this scene of research, our goal is to produce the substructure component in the meaning of IBS words. However, our innovative IBS component is limited to small buildings only. The scope of the IBS substructure component is stump and footing. In the conventional construction method, the stump and footing or pad foundation is cast in situ constructions.

Description of Innovative Mobile Precast Stump and Footing

Innovative stump and footing or substructure component is made from a special design mix of concrete relative to grade 30 MN/mm². The manufacturing process of the product at the factory or other designated place and categorized as an IBS component. Usually, this structure made on the site (cast in situ) using wood or plywood known with low durability and limited time use. This research deals with alternative materials that can be possibly used to replace conventional wood-based formwork with steel plates that are well known as durable and long-lasting. The value-added of this steel formwork is designed to be adjustable in height of stump and number or ways of corbel needed (the ready-made redundant section to attach with another structure's component).

The most benefit of this factory-made product is the better workmanship quality control and increasing the load-bearing capacity compare to on-site casting. The size of a stump is 300 x 300mm, a half stump is 300 x 300mm and the footing is 1500 x 1500mm this size of a component is recommended for building below 2 levels of floor or suitable for housing foundation.

Table 1: Stump and Footing size

TYPE	MEMBER'S SIZE (mm)			CORBEL (mm)			STARTER BAR (mm)
	W	D	L	W	D	L	
STUMP	300	300	300	125	200	200	Y12
HALF STUMP	300	300	300	-	-	-	-
FOOTING	1500	250	1500	-	-	-	Y12

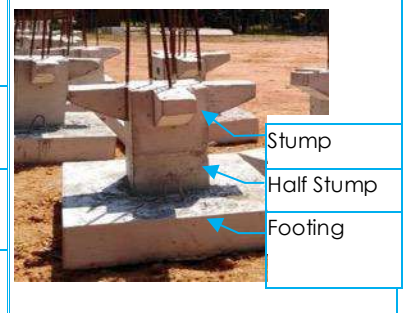

Background of The Innovation

Researchers created a mobile precast stump and footing specially designed for small buildings such as residential homes. This method of IBS is widely practiced in our country but mostly for structures of high-rise buildings. Alternatively, the researcher used a steel plate to make the formwork. This steel plate is used to produce durable and long-lasting formwork. One more special about formwork is all the building members manufactured in a pre-cast or better known as an Industrial Building System (IBS).

Innovative Mobile Precast Stump and Footing vs. Conventional Application

Conventional construction of stump and footing process is preparing and locate the formwork first, followed by laying the reinforcement and finally pouring the concrete. The construction work can't be done on a rainy day and in wet site conditions. Another deficit of this method is difficult to control the quality, take time, more costly and many more. In another way to counter the problem above, we found the precast of prefabricated stump and footing is suitable to apply. This innovative stump and footing categorized as an IBS component because it can be manufactured in the factory or other designated place. More benefit is the construction activity able to proceed during the wet day, which means extension of time (EOT) can be avoided.

Advantages of Innovation Reduction of Employees on Site

- Shorter construction periods.
- Reducing of onsite manpower.
- Reducing of construction cost.
- Reduction of waste of building materials.
- Saving building materials on site.
- Cleaner environment and construction sites
- Better quality control and safe construction sites.

Dream Comes True (Product Commercialization)

The commercialization of our research product realized under collaboration with Noha Niaga Sdn. Bhd. This company involved as a house contractor and very interested in IBS for housing. Now a day, Noha Niaga Sdn. Bhd. has set up a factory to manufacturing of various IBS products based at Kok Lanas, Kota Bharu, Kelantan. So far, the company have been completed more than 20 housing projects in the east coast region of Malaysia. The bigger or valuable project using this product is redevelopment tourist facility at Perhentian Island Resort, Perhentian Island, Besut, Terengganu. This product has been supported and recommended by CIDB Malaysia.

Acknowledgement

Thankful to Mr. Hasniro Bin Hasbullah (Director, Noha Niaga Sdn. Bhd.) for entrusting the researcher's effort and give hand to commercialize the Mobile Precast Footing and Stump. This innovative product widely used in housing construction projects especially under the PKPK member of company. Not forgetting also to CIDB IBS Sdn. Bhd. (a subsidiary of CIDB Malaysia) to become full supporters of this high-impact innovation product. Lastly, special congratulation to the Director of PKB and the secretariat of Intelligent 2021 to organize this program as the platform to realize the researcher's dreams.

References

- Maryam Quise Oliewi (2015). Industrialized Building System: The Malaysian Approach, Filspray Academy. (ISBN: 978-1-329-24296-8)
- Mohd Yuzha (2020). Taman Perindustrian IBS (Industrial Building System) Pantai Timur. Diges Penyelidikan PSMZA (vol 1 2020). UPIK. (ISSN 22317554)
- Norazilan Mazahar (2017). Pengurusan Kontraktor di Peringkat Prapembinaan. UTHM (ISBN: 978-967-2110-03-3), Ebook version: <https://www.e-sentral.com/book/info/203377/pengurusan-kontraktor-di-peringkat-prapembinaan>.
- Pekeliling Ketua Setiusaha Kementerian Kesejahteraan Bandar Dan Perumahan Tempatan (KPKT), bil. 1 tahun 2017 Kerajaan Teruskan Penarafan Skor IBS, Berita Harian, khamis, 25 April 2019.
- Penyelidik Khazanah Research Institute (2018). Dasar Perumahan Negara (2018 – 2025) "Rumah Berkualiti Harapan Rakyat", Jabatan Perumahan Negara, KPKT. (ISBN 9789839424027)

COMPRESSIVE STRENGTH OF OIL PALM SHELL CONCRETE GRADE 30

Tengku Suriati Binti Tengku Yusoff

Kota Bharu Polytechnic, Kelantan
suriati5226@gmail.com

Highlights: An attempt has been undertaken to examine the compressive strength of concrete that replaces some of its sand with medium-fine crushed oil palm shell. Oil palm shell was replaced with sand in proportions of 10%, 20%, and 30%, respectively. Volumetric portions of 20%, 30%, 40%, 50%, and 60% are utilised for combination replacement, when oil palm shell is mixed in one composition. The control in this case was Grade 30 ordinary concrete. A total of 48 concrete cubes measuring 100 x 100 x 100mm were created, along with four (4) sets of concrete mixtures. For all concrete mixes, a constant water cement ratio of 0.53 was used. Machines for ultrasonic pulse velocity (UPV) testing and compression testing were utilised. At 7 days, 14 days, and 28 days, the strength and compressive density of all specimens were measured. Using control concrete as a reference, the compressive strength of concrete with 10%, 20%, and 30% sand substitution was lowered by 5%, 16%, and 41% for oil palm shell concrete respectively. The density of oil palm shell concrete was lowered by 0.7%, 4%, and 6% after replacement of 10%, 20%, and 30%. The test findings revealed that as sand was replaced with oil palm shell, the compressive strength and density of the material dropped.

Key Words: *Crushed Oil palm shell, Compressive Strength, Grade 30, Concrete, Density*

Introduction

Concrete is a man-made material that is widely used in all sorts of construction projects across the world. Concrete, a man-made composite material, is made up mostly of cement, sand, coarse aggregate, and water. Concrete is created by combining all of the main ingredients, with the addition of additives as needed. The type of aggregate used in normal concrete affects its compressive strength (Abdullah, 1997). Concrete has a good fire resistance and is typically strong under compression. Because of its amazing versatility and relative cost in satisfying a wide range of needs, it has become a competitive building material (Sashidar and Rao, 2010). The availability of cement, sand, and coarse materials such as granite is critical to the manufacturing of concrete. Aggregates are a vital component in the production of concrete and are sourced from natural resources. Concrete will be in high demand as infrastructure building expands throughout the world.

There should be a viable alternative for substituting sand with oil palm shell, and crumb rubber as part of an effort to make optimal use of locally available resources while addressing a substantial waste disposal problem. As a result, the purpose of this study is to determine whether oil palm shell can be utilised in place of sand in conventional concrete. The purpose of this research is to investigate and analyse the impacts of concrete compressive strength using regular concrete.

Product Development, Design and Process

Achieving an ideal compressive strength for a concrete when replacing the main mixtures is something that hard to achieve without doing a lot of tests. In this experiment, oil palm shell is the main subject material for this innovation. Figure 1 shows the physical appearance of the oil palm shell used in this process. The detail process of transforming oil palm shell from their original shape into shell chipping with their particles size within the range of fine aggregate (BS 882: 1992). Therefore, the preparation of material only involves the crushing and grinding of oil palm shell.

The process begins by mixing the concrete with oil palm shell. Sand was replaced with this material with different total volumes such as 10%, 20%, and 30% to achieve the most desired compressive strength of the concrete. Next, a fixed water cement ratio of 0.53 was maintained for all concrete mixes. Ultrasonic Pulse Velocity (UPV) testing and compression testing machines were used, and the compressive strength of the concrete were tested at ages of 7 days, 14 days, and 28 days. The compressive strength of concrete with 10%, 20%, and 30% sand substitution were reduced by 5%, 16%, and 41% for oil palm shell concrete. Also subject to replacement of 10%, 20%, and 30%, the density was reduced by 0.7%, 4%, and 6% for oil palm shell concrete. The process of the experiment can be referred to figure 2: Workflow.



Figure 1: Oil Palm Shell Physical Appearance

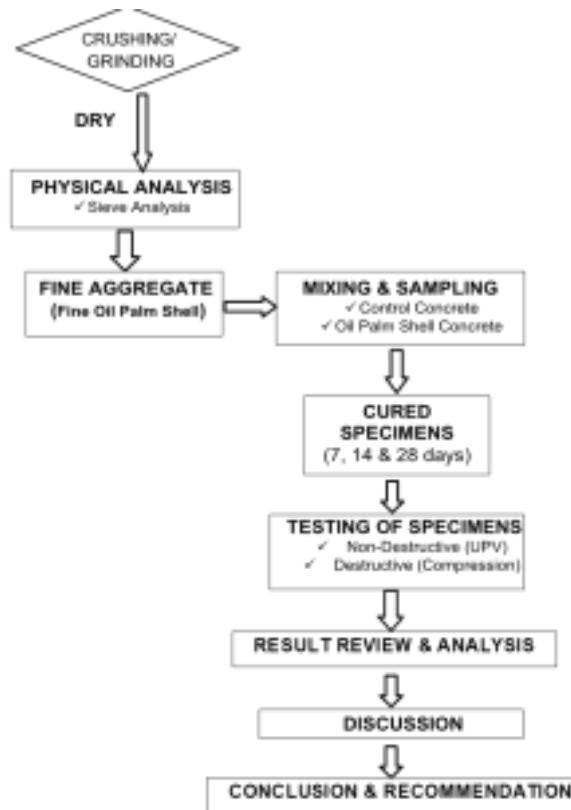

Figure 2: Workflow

Result

To ensure that the targeted desired compressive strength was achieved on day 28, the following table 1 show results of compressive strength on day 28 and total sand replacement for this experiment.

Table 1: Results of compressive strength on day 28 and total sand replacement

Mix Designation	Sand Replacement (%)		Compressive Strength (N/mm ²)
	Oil Palm Shell	Total	
CONTROL	0		36.7
Oil Palm Shell 10%	10	0	34.9
Oil Palm Shell 20%	20	20	30.5
Oil Palm Shell 30%	30	30	21.5

Discussion

The findings have shown that the overall compressive strength of concrete decreased when sand was replaced with oil palm shells. The reduction in concrete compressive strength decreased with the increments of oil palm shell volume of sand replacement. The test result also revealed that the target compressive strength of 30 N/mm² is achievable for partially replacement of sand with 10% and 20% oil palm shell. The increments of proportion replacement, the compressive strength was reduced. The replacement of sand volume by 10% with oil palm shell gave the compressive strength of 34.9 N/mm² at 28 days and 30.5 N/mm² at 20% of sand volume replacement. Therefore, it can be concluded that the best mix proportion for oil palm shell and to replace sand are 10% and 20% respectively.

Using an alternative material as replacement for the sand in concrete will give a lot of advantages especially to the environment. It will reduce the waste material produced if oil palm shell can be widely used in the real world especially in the construction field. Even though by replacing sand with alternative material resulting low strength of concrete is still a good prospect to develop if further detail study on its application is conducted.

References

- A.A.A. Abdullah (1997), "Palm Oil Shell as Aggregate for Lightweight Concrete". In S. Chandra (Ed) Waste Materials Use in Concrete Manufacturing, (Ch. 10). New York: Noyes Publications.
- A. Short and W. Kinniburgh, (1978). "Lightweight Concrete". Applied Science Publishers, London.
- BS 812-103.1:1995, Testing Aggregate - Part 103: Method for determination of particle size distributions; Section 103.1: Sieve Test. BS 1305: 1974, Specification for batch type concrete mixer
- BS 882: 1992, Specification for aggregate from natural sources for concrete.
- BS 1881-102: 1983, Testing concrete – Part 102: Method for determination of slump.
- BS 1881-108: 1983, Testing concrete – Part 108: Method for making test cube from fresh concrete.
- BS 1881-111: 1983, Testing concrete – Part 108: Method of normal curing of test specimens (20 °C method).
- Gopal Charan Bahara and Rajan Kumar Bahara, (2013). "Effect of coconut shell aggregate on normal strength concrete. Running Title: Coconut shell as coarse aggregate". Int. Journal of engineering research and technology, 2(6): 2405-2415
- K.Gunasekaran, P.S.Kumar, (2008) "Lightweight Concrete Using Coconut Shells as Aggregate" Proceedings of International Conference on Advances in Concrete and Construction, ICACC-2008", Hyderabad, India pp 450-459
- Warner B, Quirke D, and Longmore C (2007), "A review of the future prospects for the world coconut industry and past research in coconut production and product", Project No. PLIA/2007/019, Final Report, September 2007, Australian Centre for International Agricultural Research (ACIAR), Australia.
- Vishwas P. Kukarni and Sanjay Kumar B.G, (2013), "Comparative study on coconut shell aggregate with conventional concrete". International journal of engineering and innovative technology. 2(12): 67-70

RTK GPS CONSISTENCY IN VERTICAL CONTROL WORK

Nor Azme Bin Nordin

Politeknik Sultan Haji Ahmad Shah, Kuantan, Pahang
azme@polisas.edu.my

Asiah Binti Abdul Satar¹, Sulzakimin Hj Mohamed²

¹Politeknik Sultan Haji Ahmad Shah, Kuantan, Pahang,

²Universiti Tun Hussein Onn Malaysia, Batu Pahat, Johor
asiah@polisas.edu.my, zakimin@uthm.edu.my

Highlights: Technological developments in the world of measurement are growing rapidly. Various high-tech measuring tools have emerged at this time such as Terrestrial Laser Scanning, Mobile Laser Scanning, Robotic Total Station, Drone and Global Positioning System (GPS). The most popular high-tech measuring tool today is GPS. There are various satellite systems available to support the increasing usage of GPS and a new satellite system, which is the Beidou system, launched by China is one of the examples. Yet there are still surveyors who are sceptical on the ability of GPS devices in determining high accuracy in measurement data. Therefore, this study focuses on the RTK GPS method in the work of vertical control that is in the transferring of altitude values from one place to another in a short period of time. There are several altitude transferring methods in the use of GPS devices, among them are static method, fast static method, MyRTKnet method and RTK-base method. RTK-base method is also known as RTK GPS. This RTK GPS study uses CHC i70 and CHC i50 brand GPS devices made in China. The study site was conducted at six (6) stations/points at 6 different places or sites. Those places or sites are in the forest area, in area with lots of trees, under electrical power lines, on area with tall buildings, on open area (without buildings and trees) and on hills side. Observations were made in 3 days and with 3 different observation periods namely 5s, 20s and 30s at the exact station/point in order to have the consistency of GPS observation data. From the analysis, the mean is below 2cm for each area except next to tall buildings. The evening and night observation data are the best and have high accuracy values. This indicates that the GPS RTK method is appropriate with the work of vertical control as well as in having shorter measurement time.

Key words: *Altitude transfer, vertical control, RTK GPS, Satellite, Mean and Beidou system*

Introduction

In the 20th century, surveying technology in the developed countries has to be in advanced so that all infrastructure development can be carried out more quickly accurately. To implement all this, GPS play an important role and the GPS technology is continuously enhanced and improves so that a measurement technique is becoming increasing easily and fast. With the development of GPS positioning techniques, a great attention has been paid to the precise determination of local/regional geoids, aiming at replacing geometric levelling with GPS surveys (T. Engelis, Rapp, & Bock, 1985; Theo Engelis, Rapp, & Tscherning, 1984). The capability of GPS technology is fully supported by the establishment of a new satellite system, namely Beidou from China. The combination of Galileo, Glonass, Navstar GPS and BeiDou has completed satellite cycles in orbit and satisfy GPS user, especially land surveyor that allow them to do survey work easier and faster (Khomsin, Mutiara Anjasmara, Guruh Pratomo, & Ristanto, 2019; Zhang, Jin, & Lu, 2017). The technological shift to the use of GPS occurred when many surveyors said that GPS gave an accurate value in addition to a short time use. Yet there are still doubts about the accuracy of GPS measurement data when they question the consistency of observational data. There are several altitude transfer methods using GPS, among them are the Static method which requires an observation time of 1 hour and above, the fast-static method which requires an observation time of at least 10 minutes, MyRTKnet method developed by JUPEM Malaysia and RTK Base method also known as RTK GPS. This study looks at the ability of GPS in providing high accuracy on altitude transfer work using the fastest method which is RTK.

Problem Statement

The use of conventional tools such as leveling tools requires a relatively long period of work to transfer the height from one place to another. The conventional method of using ordinary leveling tools is still used but it takes a long time and requires good weather conditions to carry out work in the field (Qin, Wang, & Song, 2018; Saghravani, S.R., Mustapha, S. and Saghravani, 2009). Moreover, the use of a lot of manpower will be used and this will increase the cost of a job. Environmental weather will also play a role where it cannot be done in very hot weather because of heat waves from the road surface and also cannot be done if the weather is already dark (Beekhuizen, Kromhout, Huss, & Vermeulen, 2013; Ruginski, Creem-Regehr, Stefanucci, & Cashdan, 2019). Hence, the selection of time to do observation is important and sometimes affect the productivity. Other methods in GPS such as static and fast static methods also require a relatively long time, because after the data is observed it must be processed first using certain software (post-processing) (Baybura, Tiryakioğlu, Uğur, Solak, & Şafak, 2019; Hastaoglu & Sanli, 2011). This also affect the productivity and can be time consuming. However, GPS RTK provides the best solution because it provides information

in real time that is during direct field observations. But there are a few things that surveyors need to know before deciding to use the observed data. This is discussed in detail in this study.

Description of process

This study focuses on the selection of a suitable place and time for a height transfer measurement work to be performed. It also describes how the determination of an observational data is acceptable or not to be a final value. To see the consistency of the RTK observation data, 6 different locations of the environment were selected. The 6 locations are on a hill, under a thicket of trees, in a forest, on the edge of a building, on open ground and then under power lines. Observations at 4 different times were made at midnight, morning, noon and evening. 3 observation periods were also made i.e. at 5s, 20s 30s to see the relationship of the observation period with the consistency of the observed data.

Background of the research

Innovation to speed up the work of vertical control is the dream of every surveyor in the field. They no longer need to sunbathe for hours to get a height value using conventional tools. The purpose of this study is to facilitate the work of vertical control without requiring a long time and high cost. If before, the surveyor had to spend a whole day to make a level transfer using a regular leveling tool. Moreover, the hot weather conditions can affect the observation data and if the weather is unsuitable to do the measurement, the surveyor can no longer make any observations (Beekhuizen et al., 2013; de Moraes Ramos, Mai, Daamen, Frejinger, & Hoogendoorn, 2020; Jamil, Nomanbhoy, & Mohd Yusoff, 2012). With the advent of GPS technology, exploration of the use of this tool is becoming more widespread in assisting surveyors in the field. Instead of hour-long static observations, surveyors are now switching to the GPS RTK method which uses an observation time of a minimum of 5 seconds to make a vertical control transfer. But what was just a brief observation can be adopted. If according to the Circular of the Director General of Survey and Mapping Malaysia No. 6/1999 (KPUP No. 6/1999) the differences adopted in the measurement work are 3 for north, 3 for east and 6 for altitude. However, to meet the criteria of high accuracy data, the allowable limit is $= (0.012 \sqrt{K})$ m where K = total distance in kilometers (ALI, 2008; Mohamed, 1999; PKPUP Bilangan 6 Tahun 2009, 1999).

Important to education

This study is related to the survey science taught in every polytechnic, university and private college that has Geomatics courses where they have their own GPS equipment. The basic knowledge has been applied in theory classes and exploration in research using GPS should be introduced and this is the best platform to expose it to them. It also will be a guidance for them to pursue their career as a land surveyor after graduated.

Advantages of process towards education and community

The results of this study indicate an appropriate observation time to make the vertical control. Appropriate time and observation times to perform vertical control have also been demonstrated. This study will serve as a guideline to students majoring in surveying and land surveyors in the field, how they should be deterministic and keep their work within allowable deviations or limits. This is because although GPS is becoming increasingly popular, there is no clear guide on how the data of a measurement can be verified or give confidence to users.

Result and analysis

Table 1: Reading from Observation

Code	Day	Mean Height				Error (Compare with real data value)			
		Morning	Noon	Evening	Night	Morning	Noon	Evening	Night
BO	Wednesday	55.671	55.664	55.657	55.666	0.016	0.008	0.002	0.011
	Thursday	55.669	55.841	55.645	55.666	0.014	0.186	0.010	0.011
	Saturday	55.66	55.584	55.649	55.684	0.005	0.071	0.001	0.029
BP	Wednesday	55.679	55.642	55.659	55.658	0.004	0.033	0.016	0.017
	Thursday	55.72	55.704	55.674	55.658	0.045	0.029	0.001	0.017
	Saturday	55.734	55.701	55.673	55.719	0.059	0.026	0.006	0.044
AB	Wednesday	59.238	59.217	59.228	59.285	0.008	0.029	0.018	0.039
	Thursday	59.283	59.3	59.294	59.285	0.037	0.054	0.048	0.039
	Saturday	59.276	59.297	59.238	59.294	0.03	0.051	0.008	0.048
DH	Wednesday	58.283	58.443	58.31	58.268	0.014	0.146	0.013	0.029
	Thursday	58.332	58.367	58.322	58.268	0.035	0.07	0.025	0.029
	Saturday	58.337	58.28	58.297	58.331	0.04	0.017	0.000	0.034
TL	Wednesday	51.66	51.655	51.68	51.719				
	Thursday	51.708	51.728	51.713	51.719				
	Saturday	51.706	51.747	51.678	51.736				
TA	Wednesday	64.903	64.874	64.911	64.927				
	Thursday	64.933	64.925	64.936	64.927				
	Saturday	64.931	64.923	64.907	64.933				

In Table 1, it shows two observation, namely the average observation height for 6 stations by day and time to show the consistency of observation data using RTK GPS and the average height at four stations compared to the actual value using a level to show the accuracy of observation data. BO is the code for a GPS station erected next to a tall building, BP is the code for a GPS station erected under a lush tree, AB is a station on a hill, DH is a station in a forest, TL is a station on open area land while TA is a station erected under power lines. Referring to the average height, the green color indicates high accuracy and very consistent observation data, the light blue color of the data is still acceptable and consistent while the red color indicates very inconsistent observation data by day. Consistency means that the data observed tomorrow should match the data observed today and the following days. Clearly, the data are very inconsistent at noon observation time and very consistent in the afternoon and evening. This is also the possibility of ionosphere interference on data from satellites (Erickson, Perley, Flatters, & Kassim, 2001; Norin, Grach, & Thidé, 2006; Tang, Yao, Kong, & Zhang, 2016).

Referring to the error value i.e. the averaged observation value is differentiated from the actual value of the scale indicates some important things that every surveyor in the field needs to know. First, the dark green colored column indicates high accuracy and is suitable for making vertical control transfers or making Temporary Bench Mark (TBM). The best time to make an elevation level transfer is in the afternoon. Second, the dark blue colored space indicates low-accuracy data and is only suitable for topographic measurement work. All times are suitable for doing topographic work everywhere except in the woods and next to tall buildings at noon only. The observation data at noon will be unsatisfactory for areas in the forest and the edges of buildings due to the influence of ionosphere and multipath error (Gülmez & Tuşat, 2017; Mubarak, 2020; Pahlevi, Prijatna, Meilano, & Sofian, 2017; Zhang et al., 2017). Therefore, it is not recommended to make level transfers and vertical control at noon. From the data analysis it is clear that the RTK GPS method can replace the static GPS method and the conventional method of using level tools to do level transfer and vertical control work provided the surveyor must know the appropriate time and place to establish a new vertical control station or TBM.

Acknowledgement

The authors would like to express appreciation to Jabatan kejuruteraan Awam, POLISAS, Tropo Survey Enterprise, Perunding Ukur Adam and CSIEM, FPTP, UTHM for the support and encouragement on this research.

References

- Ali, D. H. (2008). Penentuan kedudukan Sejagat (GNSS) Yang Menggunakan Perkhidmatan Malaysian RTK GNSS NETWORK (MyRTKnet). *Pekeliling Ketua Pengarah Ukur Dan Pemetaan Bilangan 1 Tahun 2008*, 1, 61.
- Baybura, T., Tiryakioğlu, İ., Uğur, M. A., Solak, H. İ., & Şafak, Ş. (2019). Examining the Accuracy of Network RTK and Long Base RTK Methods with Repetitive Measurements. *Journal of Sensors*, 2019. doi:10.1155/2019/3572605
- Beekhuizen, J., Kromhout, H., Huss, A., & Vermeulen, R. (2013). Performance of GPS-devices for environmental exposure assessment. *Journal of Exposure Science and Environmental Epidemiology*, 23, 498–505. doi:10.1038/jes.2012.81
- De Moraes Ramos, G., Mai, T., Daamen, W., Frejinger, E., & Hoogendoorn, S. P. (2020). Route choice behaviour and travel information in a congested network: Static and dynamic recursive models. *Transportation Research Part C: Emerging Technologies*, 114, 681–693. doi:10.1016/j.trc.2020.02.014
- Engelis, T., Rapp, R. H., & Bock, Y. (1985). Measuring orthometric height differences with GPS and gravity data. *Manuscripta Geodaeica*, 10, 187–194.
- Engelis, T., Rapp, R. H., & Tscherning, C. C. (1984). The precise computation of geoid undulation differences with comparison to results obtained from the Global Positioning System. *Geophysical Research Letters*, 11, 821–824. doi:10.1029/GL011i009p00821
- Erickson, W. C., Perley, R. A., Flatters, C., & Kassim, N. E. (2001). Ionospheric corrections for VLA observations using local GPS data. *Astronomy and Astrophysics*, 366, 1071–1080. doi:10.1051/0004-6361:20000359
- Gülmez, S., & Tuşat, E. (2017). The Analysis of GPS Data in Different Observation Periods Using Online GNSS Process Services. *International Journal of Environment and Geoinformatics*, 4, 43–53. doi:10.30897/ijgeo.306492
- Hastaoglu, K. O., & Sanli, D. U. (2011). Accuracy of GPS rapid static positioning: Application to koyulhisar landslide, central Turkey. *Survey Review*, 43, 226–240. doi:10.1179/003962611X12894696205145
- Jamil, H., Nomanbhoy, Z., & Mohd Yusoff, M. Y. (2012). Underground Utility Mapping and Its Challenges in Malaysia. *FIG Workshop Week 2012*, 1–27.
- Khomsin, Mutiara Anjasmara, I., Guruh Pratomo, D., & Ristanto, W. (2019). Accuracy Analysis of GNSS (GPS, GLONASS and BEIDOU) Observation for Positioning. In *E3S Web of Conferences* (Vol. 94). doi:10.1051/e3sconf/20199401019
- Mohamed, A. M. (1999). *Guidelines For Using Global Positioning System (GPS) Equipments For Cadastral Control Measurement and Cadastral Measurement*. Department of Survey and Mapping Malaysia (Vol. 6, pp. 19 – 89).
- Mubarak, O. M. (2020). The Effect of Carrier Phase on GPS Multipath Tracking Error. *Engineering, Technology & Applied Science Research*, 10, 6237–6241. doi:10.48084/etasr.3578
- Norin, L., Grach, S. M., & Thidé, B. (2006). On the linear stage of thermal parametric instabilities in the ionosphere excited by HF pumping near electron gyroharmonics. *Advances in Space Research*, 38, 2527–2532. doi:10.1016/j.asr.2004.12.014
- Pahlevi, A. M., Prijatna, K., Meilano, I., & Sofian, I. (2017). Investigation Of The Solid Earth Tide Based On Gps Observation And Superconducting Gravimeter Data. *Jurnal Ilmiah Geomatika*, 22, 29. doi:10.24895/jig.2016.22-1.488
- PKPUP Bilangan 6 Tahun 2009. (1999). *Garis Panduan Pengukuran Menggunakan Alat Sistem Penentuan kedudukan Sejagat (GPS) bagi Ukuran Kawalan Kadaster dan Ukuran Kadaster*. Jabatan Ukur dan Pemetaan Malaysia.
- Qin, S., Wang, W., & Song, S. (2018). Comparative study on vertical deformation based on GPS and leveling data. *Geodesy and Geodynamics*, 9, 115–120. doi:10.1016/j.geog.2017.07.005
- Ruginski, I. T., Creem-Regehr, S. H., Stefanucci, J. K., & Cashdan, E. (2019). GPS use negatively affects environmental learning through spatial transformation abilities. *Journal of Environmental Psychology*, 64, 12–20. doi:10.1016/j.jenvp.2019.05.001
- Saghravani, S.R., Mustapha, S. and Saghravani, S. F. (2009). Accuracy comparison of RTK-GPS and automatic level for height determination in land surveying. *MASAUM Journal Of Reviews and Surveys*, 1, pp.10–13. Retrieved from <https://www.researchgate.net/publication/235423752>
- Tang, J., Yao, Y., Kong, J., & Zhang, L. (2016). Large-scale traveling ionospheric disturbances using ionospheric imaging at storm time: A case study on 17 march 2013. *Journal of Atmospheric and Solar-Terrestrial Physics*, 145, 12–20. doi:10.1016/j.jastp.2016.04.006

SMART RECYCLE BIN SYSTEM(I-BIN)

Anuar Bin Mohamed Kassim

Universiti Teknikal Malaysia Melaka, Hang Tuah Jaya, 76100 Durian Tunggal Melaka, MALAYSIA
anuar@utem.edu.my

Muhammad Mustaqiim Bin Roslan, , Muhammad As Shakirin Bin Abdul Aziz, Muhammad Muslim Bin Mohd Rashidin, Muhamad Afiq Shahmi Bin Shamsul Izran, Sahrul Bin Sahak, Muhammad Malek Faizal Bin Mohammad Zaini, Awangku Khairul Ridzwan Bin Awangku Jaya

Universiti Teknikal Malaysia Melaka, Hang Tuah Jaya, 76100 Durian Tunggal Melaka, MALAYSIA
AURO Technologies PLT, Ayer Keroh, Melaka, MALAYSIA
anuar@utem.edu.my, auro@aurotechsolutions.com

Highlights: A smart city is an urban area that uses different types of electronic and communications methods and sense to manage assets, resources and services efficiently. The natural resources which can be used to produce the paper and plastic are critically decreased. The smart system to sort the waste effectively are highly demand. Therefore, the smart recycle bin is a product which can recognize and sort the waste automatically. This product is generated by using smart sensor system with the artificial intelligence to sort the waste effectively. This product is developed with the novel detection based in the materials of the trash such as paper, plastic and metal. The developed I-BIN is low-cost and smart sensor system with the artificial intelligence to sort the waste accurately. The IoT system are integrated with the smart recycle bin to ensure the air quality and waste level can be monitored by the authorities. This product can ensure the smart cities and smart tourism can be realized.

Key words: *intelligent recycling system, trash sorting, paper, plastic, metal,*

Introduction

Resource management are very important in the country to maintain the resource that cannot be replaced in the future. Malaysia has a lot of resources such as petroleum, gas and other natural resources. The other natural resources are such as trees in the forest, minerals for metal fabrication, sand for glass production and etc. Even though Malaysia still has a lot of resources, we cannot forget, all the resources will be drained and reduced yearly, if we do not manage and use the resources wisely.

While in Japan, the citizen has been educated in school on how to manage and sort the trash wisely started during primary school. There are some rules in Japan in term of trash collection activity that need to be followed by the resident in order to ensure our household trash will be collected by the garbage collection company. There is year garbage calendar that will be distributed by the city hall to the resident to show the day that the type of garbage will be collected in the month.

On the other hand, the resource management can protect our resources. There are some other benefits that can be given to the country and the community. The benefit of resource management to the country and the society. The benefit that are identified to the society such as protecting ecosystems and wildlife, reducing demand for raw materials, saving energy, cutting climate-changing carbon emissions, cheaper than waste collection and disposal and creating jobs.

Besides, recycling is the process of collecting and processing materials that would otherwise be thrown away as trash and turning them into new products. Recycling can benefit your community and the environment. Malaysia generates 37890 tonnes of solid waste per day. Natural resources which can be used to produce paper, metal and plastic are critically decreased year by year. The recycle process to reuse natural resources are very important.

Conventionally, waste sorting is the process by which waste is separated manually at the household. The problem faced are recycle waste mixed up, decreasing its value and no trash collection schedule. The intelligent system that can sort the waste easily and effectively are highly demand. The problem we faced are recyclable waste mixed up, decreasing its value and no trash collection schedule.

In previous study, Mohd Yusof, Norfadzlia & Zulkifli, mohd faizal & Mohd Yusof, Nur & Azman, Nur. (2018) also has reported that usage of Wi-Fi connection to provide real-time information about the solid waste management. Shukla, Shashank & Shukla, Neeraj. (2017) has also done the literature survey on the smart waste collection system based on IoT (Internet of Things). Through this paper, there are promising technology such as IoT to monitor and give direct information about the smart waste collection system. However, the main issue was on the trash sorting system that need to be improved in order to reduce the solid waste to be reuse and recycle into other application and items.

Soni, Gulshan & Kandasams, Selvaradjou. (2018) also has done the comprehensive literature survey on the smart garbage bin systems. There a lot of potential of new technologies that can be enhance to achieve smart city development. N, Shamin & Peer, Mohamed Fathimal & R, Raghavendran & Prakash, Kamalesh. (2019) also has introduce the Smart Garbage Segregation & Management System Using Internet of Things(IoT) & Machine Learning(ML). This system is too complex and difficult to be used and highly maintenance cost. S, S., K, S., V, M., & C, C. (2018) also has introduce the Smart waste management system which also describe on the waste management which can be beneficial for smart city development.

Product description

In this project, there are some objective that will be done to achieved the functionality of this product. The objectives of this product is to develop a smart recycle bin that called IBIN which can sort the trashes automatically based on the type of materials such as plastic, paper, and metal. Besides, the proposed prototype also need to be intelligent and protect the user from danger to touch the trash bin while throwing the trash. Finally, the proposed prototype also can give indicator to the garbage collector company which garbage has been filled and can collect efficiently.

In order to develop this innovative product, we have started this project with the scratch of the project idea and picturing the functionality of the product. Through this design, the IBIN is a product which can recognize and sort the waste automatically. IBIN is consisted a cutting edge smart sensors that can sort different types of trash excellently. IBIN can sort three types of trashes such as, plastic, paper, and metal. All this trashes are valuable and can be recycled and reused for other applications. Figure 1 shows the developed IBIN with components label indicate the position of the sensors and the parts inside the IBIN.



Figure 1 Developed prototype IBIN

IBIN also has smart non-touch sensor by using the distance sensor to detect users hand or trash and can open the bin cap automatically without touching the cap. Charlesworth, John & Temple, J.. (2021) shown the usage of tiem of flight that can be used to measure the distance and can be applied for various application through non touch concept. This function can be useful to prevent our hands to touch the dirty bin especially during this pandemic COVID-19. The level of the trash inside the IBIN also can be monitored in real time. The notification will be sent to local authority to collect the trash efficiently through Telegram. This product is generated by using smart sensor system with the artificial intelligence to sort the waste effectively. This product is developed with the novel detection based in the materials of the trash such as paper, plastic and metal. The developed IBIN is low-cost and smart sensor system with the artificial intelligence to sort the waste accurately.

The IoT system are integrated with the smart recycle bin to ensure the air quality and waste level can be monitored by the authorities. This product can ensure the smart cities and smart tourism can be realized. The flowchart of the IBIN to process the trash from sorting process up to notification to the local authority for collection process. The user notification is very important to alert people to take care the trash to be collected efficiently. The level of the trash based on different materials can be monitored by using the ultrasonic sensor installed in the IBIN.

Therefore, though using this invention, the user can be alerted once the IBIN has been filled up with the trash. Therefore, the smart recycle system that can recognize and sort the waste automatically and effectively is developed. IBIN based on the sensor use. If the threshold of the trash based on material detected is activated. The location of the smart recycle bin that need to be collected will be given to the Dashboard such as Google Map at the trash collector company and the local authorities. This will give cost reduction on the oil usage for the trash collector when manage the trash collection effectively and wisely. On the other hand, the Telegram application will be used to give the notification to the user directly and real time.

The technology inside the IBIN, I have identified there are a lot of novelty and inventiveness step that can be registered under intellectual properties in Malaysia Intellectual Properties Office (MYIPO). The intellectual properties that can be registered such as are patent, copyright, industrial design and trademark. The IBIN can be registered as trademark of this product while the algorithm to sort the trash can be registered as copyright. On the other hand, the functionality and the inventiveness step of the IBIN can be registered as patent. Finally, the aesthetically designed of the IBIN can be registered as industrial design category. Where the small scale of prototype system was verified ad demonstrated.

Table 1: Competition matrix

Photo			
Name	i-BIN	Conventional dustbin	Smart dustbin
Function for sorting system	Can sort the trash into different materials such as plastic, paper and metal automatically	Cannot sort metal and mixed together	Cannot sort metal and mixed together
Smart function	Can open the trash cap non touch approach	Open manually using hand/ leg	Can open the trash cap non touch approach
Trash Level indicator	Yes for each material	No	No
Notification to the user/ authority	Yes through Telegram	No	No
User friendliness	Yes, will attract more people to use and easy to use especially kid	No	Yes but only for opening the trash cap

Commercial viability

The commercialization potential of this intelligent product will be done through Ministry Of Housing And Local Government and the local authorities such as Majlis Bandaraya Melaka Bersejarah (M.B.M.B) and Majlis Perbandaran Hang Tuah Jaya (M.P.H.T.J). We also targeting the trash management company in south region such as SWM Environment Sdn Bhd. We hope, through this intelligent product, the agenda to build the smart cities to manage resources wisely will become easier and can be realized. The local authority with the trash management company which are highly potential for this innovative product.

Intellectual properties

The technology readiness level for this product in in TRL 5. Where the small scale of prototype system was verified. In term of intellectual properties, this product has been registered under statutory of declaration of copyright and the copyright by MY.I.P.O. The registered copyright number isLY2021W00461.

Product impact

Finally, there are some impact that can be obtained from this project. The impact study can be classified into three categories which are:-

1. Social

In term of social impact, by development and fabrication of the IBIN, it will generate more employability opportunity for the citizen in Malaysia. Besides, it also can give awareness to the society on how important the 3R (Reduce, Recycle, Reuse) in the community and the country. From the new employment increased, it will give higher quality of life to the society.

2. Economy

In term of economy, it can generate more money and increase economy to our country. From employability rate increase, the increment of the economy in this country also can be increased. By using this product, it can ensure the smart cities and smart tourism can be realized. A lot of tourist from inside and outside of our country are welcome. The tourism sector will be active and a lot of people can also get benefit by making good business especially in Melaka City. On the other hand, the lower demand for raw material also can be realized.

3. Ecology

Besides, this product also can save environment and benefit to our ecology. In term of the environment for example the tourism area such as unwanted smell and uncontrolled trash can be always been monitored. With the usage IBIN, the fuel for the trash collector truck can be reduced due to smart scheduling system based on the data given by the IBIN. At the same time, this product can give a lot of benefit to the environment where the natural resources can be recycled easily and the gases emitted to the air by the trash collector truck can be reduced. This can help to conserving natural resources and protect the ecosystem, wildlife, and cutting carbon emission saving energy.

Therefore, through all the explanation of the IBIN, our motto for IBIN is consist of 4 E's which are Excellent, Economy, Efficient and Ecology.

References

- Suhaila Shahrul Anuar. (2019). Rakyat Malaysia hasil 37890 tan sisa setiap hari, Berita Harian, 11 June 2019
- Charlesworth, John & Temple, J.. (2021). Engineering Applications of Ultrasonic Time-of-Flight Diffraction.
- Mohd Yusof, Norfadzlia & Zulkifli, mohd faizal & Mohd Yusof, Nur & Azman, Nur. (2018). Smart Waste Bin with Real-Time Monitoring System. International Journal of Engineering & Technology. 7. 725. 10.14419/ijet.v7i2.29.14006.
- Shukla, Shashank & Shukla, Neeraj. (2017). Smart Waste Collection System based on IoT (Internet of Things): A Survey. International Journal of Computer Applications. 162. 42-44. 10.5120/ijca2017913381.
- Soni, Gulshan & Kandasamy, Selvaradjou. (2018). Smart Garbage Bin Systems – A Comprehensive Survey. 10.1007/978-981-10-7635-0_15.
- N, Shamin & Peer, Mohamed Fathimal & R, Raghavendran & Prakash, Kamalesh. (2019). Smart Garbage Segregation & Management System Using Internet of Things(IoT) & Machine Learning(ML). 1-6. 10.1109/ICIICT1.2019.8741443.
- S, S., K, S., V, M., & C, C. (2018). Smart waste management system. International Journal of Scientific Development and Research [IJS DR]

A STUDY ON RECYCLED TYRES AS AN ADDITIVE IN CONCRETE MIXTURE

Nor Abidah binti Abdul Hamid

Polytechnic of Kota Bharu, Kota Bharu, Kelantan
norabidah8110@gmail.com

Nur Ezzah binti Mohd Sidik, Siti Farah binti Mohd Sidik

Polytechnic of Kota Bharu, Kota Bharu, Kelantan
eyzahsidik.00@gmail.com, farahsidik.00@gmail.com

Highlights: Nowadays, uncontrolled disposal of waste materials such as tyres can affect the green environment. Therefore, careful management of waste disposal must be done in order to conserve the environment. To minimize this problem from becoming more serious, a study on pieces of recycled tyres in the concrete mixture was conducted to determine whether tyres can act as an additive in concrete. The size of the tyre pieces was in the range between 10 – 20 mm and the mixture of tyres in concrete are 3% and 5%. 18 concrete cubes measuring 150 mm x 150 mm x 150 mm were prepared for controlled and innovation sample. All the samples were preserved for 7 and 28 days and the result were compared with the controlled concrete sample. Based on the research findings, concrete with recycled tyres has higher workability compared to control sample. However, the compressive strength of the concrete with recycled tyres is slightly lower than controlled sample, but it is still acceptably strong.

Key words: recycled tyres, additive, concrete mixture, compression test

Introduction

Concrete is very useful and flexible to be poured in formwork. Since its set, the rigidity and strength of concrete become priority. This is because concrete functions by carrying a loading from dead load and live load. Concrete mix consists of cement, sand and aggregate. Recently, concrete use is becoming prevalent in line with economic growth. Aggregate is the one of the most important components used in the manufacture of concrete. To protect natural resources, the use of aggregate in concrete production can be reduced by using alternative material either recycled or discarded waste. The number of waste tire rubber generated annually in the country was estimated to be 8.2 million or approximately 57,391 tonnes. About 60% of the rubber tires waste is disposed via unknown routes (S. K. Thiruvangodan et al., 2016). The use of recycled materials generated from the transportation, industrial, municipal and mining process in transportation facilities is an important issue. The growing amount of solid waste can be reduced by making solid waste as an additive in concrete.

Methodology

Concrete mixtures produced by adding a different percentage of recycled tyres in the sample preparation. 18 cubes were prepared for controlled and innovation sample. Determining the appropriate materials and standards is a key step prior to concrete mixing. Among the materials needed to produce a concrete mixture are cement, aggregate, recycled tyres and water. The ratio stipulated in the concrete mixture is 1:2:4. Ordinary Portland cement was used as the cement. Ordinary Portland cement is used in Malaysia and must meet the requirements of BS 1881. The methodology starts with the collection rubber waste as a raw material. Several testing have been conducted were slump test and compression test. Water-cement ratio used in this study was set to 0.5 for all samples for consistency and measured by the weight of water to solidify. Too much water-cement ratio will make the concrete weak and not durable. Water-cement ratio was determined by taking the weight of the water divided by the weight of cement. Lower water-cement ratio will increase the concrete strength. Recycled tyres is a material used in this research. Recycled tyres was cut with a hacksaw into pieces measuring 10-20 mm.

Result and Findings

Slump test is important to check the workability of concrete. The overall test results are shown in Table 1 below.
 Table 1: Result of slump test

Samples	Percentage of recycled tyres by mass (%)	Slump (mm)
A	0	70
B	3	70
C	5	75

For compression test, a concrete cube of 150 mm x 150 mm x 150 mm size was used as a compression test cube. Figure 1 below illustrates the different strength of concrete in terms of strength of concrete with recycled tyres and controlled concrete.

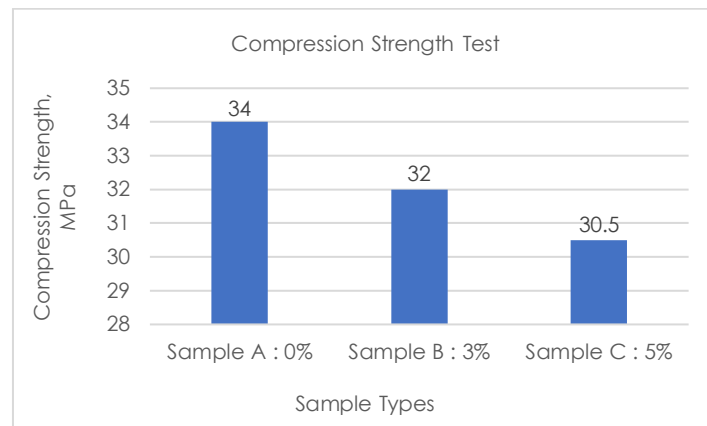

For the conclusion, the result and analysis show that when recycled tyres is added to the concrete mix with increasing percentage, the workability of concrete is increased up to a certain level. However, compressive strength value of concrete was decreased due to increase among of recycled tyres that affect adhesion deficiency in the concrete mix and soft rubber particles act as voids in the concrete. Recycled tyres are more likely to fill in the pores of concrete mix, which reduces the compression of the concrete. However, the concrete mixtures for 3% and 5% are still acceptable because they had exceeded 30 MPa in this experiment. The compressive strength of the concrete with recycled tyres has lower strength compared to the control concrete, but the strength is acceptably strong.

Acknowledgement

We would like to thank Kota Bharu Polytechnic, Kelantan for their assistance and technical management as well as space and assets belonging to the institution during the process of conducting this research.

References

- S. K. Thiruvangodan (2016). Waste Tyre Management in Malaysia : Degree Thesis, Universiti Putra Malaysia.
- Ali O. Atahan, Ayhan Oner Yucel (2012). Crumb Rubber In Concrete Static And Dynamic Evaluation. *Construction And Building Materials*, 617 – 622.
- Abdullah S R, Wan Zainal Abidin W R and Shahidan S (2016). Strength Of Concrete Containing Rubber Particle As Partial Cement Replacement *MATEC Web Conf.* vol 47 (Paris: EDP Sciences), 2 – 5.

SELF-ENERGY GENERATION BUILDING: PORTABLE E-STORAGE DEVELOPED VIA RENEWABLE ENERGY (RE)

Salmiah Binti Aziz

Universiti Malaysia Kelantan, Bachok, Malaysia
salmiah.a@umk.edu.my

Siti Nuratirah Binti Che Mohd Nasir¹, Mohammed Fadzli Bin Maharimi¹, Neha R Jacob²

¹Universiti Malaysia Kelantan, Bachok, Malaysia

²Greets Public School, Kerala, India

nuratirah.mn@umk.edu.my, fadzli.m@umk.edu.my, nhcob07@gmail.com

Highlights: Portable energy storage (E-Storage) is developed based on the supercapacitor (SC) concept that's applied in electric transports generated by renewable energy (RE). The reason Portable E-Storage was developed based on the people's needs for electricity during natural disasters, unstable weather sometimes affected by cutoff electricity supply, and resolution of environmentally friendly building energy efficiency. The advantages of the Portable E-Storage such as saving consumer money, improving reliability and resilience, integrating RE generation sources and helping reduce environmental impact. Benefits for the education field and consumers are that product development promotes environmentally friendly products for current and future generations in terms of usability and its application. Green Hydrogen (H₂) is used as the main material and cell to create and generate electricity, it's made the electric generation process free from carbon footprint and environmentally friendly. In short, the smart grid for electric distribution connected to every building, residential buildings and other needs such as for transportation and industry.

Key words: *electricity, energy efficiency, energy storage, portability, renewable energy, self-energy building*

Introduction

Portable energy storage (E-Storage) is developed based on the supercapacitor (SC) concept that's applied in electric transports generated by renewable energy (RE). The reason Portable E-Storage was developed based on the people's needs of the electricity during natural disasters, unstable weather sometimes it's affected of cutoff electricity supply, and resolution of environmentally friendly building energy efficient. The advantages of the Portable E-Storage such as it's can save consumer money, improve reliability and resilience, integrate RE generation sources and help reduce environmental impact. Benefits for the education field and consumers are the product development promotes environmentally friendly product for current and future generation in term of usability and its application. As used Green Hydrogen (H₂) as main material and cell to create and generate electricity, it's made the electric generation process free from carbon footprint and environmentally friendly. In short, the smart grid for electric distribution connected to every building, residential buildings other needs such as for transportation and industry.

Content

Current issues of climate change are a hot topic addressed by many voices. The Paris Agreement stated an emergency on carbon footprint to be controlled by 2050. The Paris Agreement's long-term temperature goal is to keep the rise in global average temperature to well below 2 °C (3.6 °F) above pre-industrial levels, and to pursue efforts to limit the increase to 1.5 °C (2.7 °F), recognizing that this would substantially reduce the impacts of climate change. This should be done by reducing emissions as soon as possible and achieving a net-zero emissions in the second half of the 21st century. The Paris Agreement speaks of the vision of fully realizing technology development and transfer for both improving resilience to climate change and reducing Greenhouse gas (GHG) emissions. It establishes a technology framework to provide overarching guidance to the well-functioning Technology Mechanism. The mechanism is accelerating technology development and transfer through it's policy and implementation arms (United Nations; Climate Change).

With global emissions are reaching record levels and showing no sign of peaking, UN Secretary-General António Guterres called on all leaders to come to New York on 23 September 2019 for the Climate Action Summit with concrete, realistic plans to enhance their nationally determined contributions by 2020, in line with reducing greenhouse gas emissions by 45 per cent over the next decade, and to net zero emissions by 2050 (United Nations).

New approach and application of new clean energy such as so-called renewable energy (RE) for power generation to produce electricity is hope for the future backup as current and conventional power generation uses non-renewable energy (NRE) sources such as fossil fuel, natural gas and coal combustion. This NRE will be depleted until a certain time, which is unknown but promising. By 2030, zero-carbon solutions could be competitive in sectors representing over 70% of global emissions.

Portable Energy Storage

Portable energy storage (E-Storage) is developed based on capacitor or supercapacitor (SC) concept such as applied in electric transports that's generated by RE. Self-energy generation building refers to a building that can sustain its electric supply of the building by the established power generation of resources available locally. The reason Portable E-Storage developed as based the people needs of electricity during natural disasters, unstable weather sometimes its affected cut-off electricity supply, and resolution of environmentally friendly building energy efficient. The advantaged of the Portable E-Storage such as it's can the save consumer money, improve reliability and resilience, integrate RE generation sources and help reduce environmental impact. The potential of product marketability is promising as the product developed based on the person's needs and potential for application of RE power generation for self-energy building to reduce environmental impact.

Product Description (Pictures/Data/Result/Discussion)

Portable energy storage (E-Storage) is developed based on capacitor or supercapacitor (SC) concept such as applied in electric transports that's generated by renewable energy sources (RE). Supercapacitors are a new type of capacitor, also known as ultra-capacitors. The characteristics of supercapacitors give them a higher capacitance than conventional capacitors. Self-energy generation building referred to a building that's can sustain its electric supply of the building by the established power generation of RE sources available locally. Portable E Storage developed based on the concept of using Green Hydrogen (H₂) to produce electricity and generated electricity stored in the Portable Capacitor and Supercapacitor (as electric energy storage) in every building or home based on different power needs and electric capacity. A supercapacitor's lifetime spans 10 to 20 years, and the capacity might reduce from 100% to 80% after 10 or so years. Electric power generations deployed from renewable energy sources. As used Green Hydrogen (H₂) as main material and cell to create and generate electricity, it's made the electric generation process free from carbon footprint and environmentally friendly. In short, the smart grid for electric distribution connected to every building, residential buildings other needs such as for transportation and industry. Figure 1.0 shows a smart grid system deployed renewable energy sources to generate electricity.

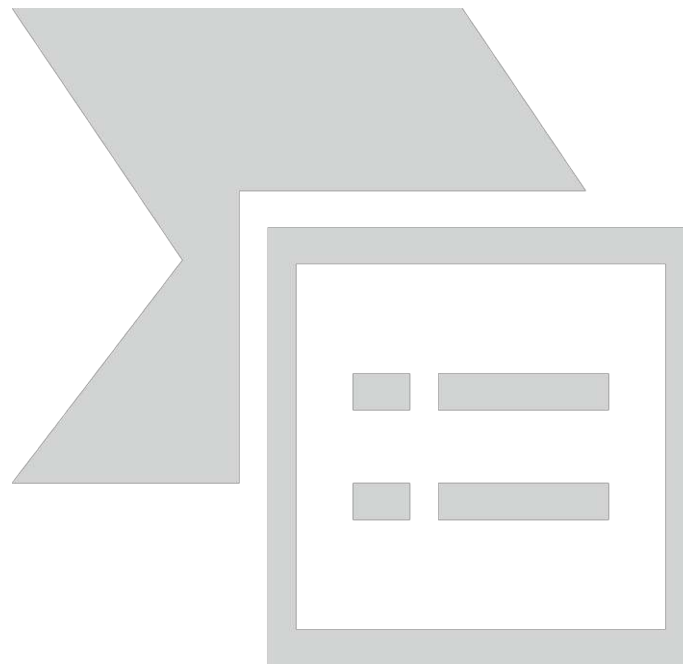

Figure 1.0: A smart grid system deployed renewable energy sources to generate electricity

Product Advantages

The advantages of the Portable E-Storage such as it can save the consumer money (save energy and low cost), improve reliability and resilience, integrate RE generation sources and help reduce environmental impact. Benefits for the education field are that product development promotes environmentally friendly products for current and future generations in terms of usability and its application. At the same time Portable E-Storage based on RE plays an important role for e-learning activities, work from home (WFH) and especially for the buildings in remote areas that need most of electric supply and power production during cutoff of electricity because of unstable weather or by the natural disasters. The Portable E-Storage provides flexibility for the grid, to ensure uninterrupted power to consumers. Other than that, application of Portable E-Storage for self-energy generation building may control electric usage, improve reliability at times of unexpected failures or disasters and it can maintain and improve power quality in terms of frequency and voltage.

Product Novelty/Inventiveness

The potential of product marketability is promising as the product developed based on the person's needs and potential for application of RE power generation for self-energy building to reduce environmental impact. The on-going research & development (RD) of supercapacitor technology by the researchers may impact to the society as needs of it and needs more development of electric energy storage for current and the future in order to recover the Earth from carbon footprint (total greenhouse gas emissions).

Commercialisation

The potential of product marketability is promising as the product developed based on the person's needs and potential for application of RE power generation for self-energy building to reduce environmental impact. Portable E-Storage may be used by every house owner or building owner. Other than that, the researchers encourage developer also may apply the Portable E-Storage as one of must have item for sustainable project development. Overall idea proposed by the researchers of a smart grid system deployed from RE to produce electricity may be used and apply for national scale in order to achieve zero-emission target in the future.

Others (Publication/Intellectual Property/Industry)

This innovative design is owned by the researchers and can't be reproduced without permission by the researchers. The project title is extracted from an on-going PhD thesis of Salmiah Aziz that's she currently studied her PhD in Universiti Sultan Zainal Abidin (Unisza).

Acknowledgement

The researchers would like to thank Minjo from India for providing in-depth information and facts on energy storage input.

References

- United Nations (Climate Change). (n.d.). The Paris Agreement. Retrieved July 15, 2021, from <https://unfccc.int/process-and-meetings/the-paris-agreement/the-paris-agreement>
- United Nations. (n.d.). Sustainable Development Goals: Goal 13: Take urgent action to combat climate change and its impacts. Retrieved July 15, 2021, from <https://www.un.org/sustainabledevelopment/climate-change>

WASTE TO WEALTH: CASSAVA PEEL STARCH BIOFLOCCULANT

Norzila Othman

Universiti Tun Hussein Onn Malaysia, Batu Pahat, Johor, Malaysia
norzila@uthm.edu.my

Syazwani Mohd Asharuddin

Universiti Tun Hussein Onn Malaysia, Batu Pahat, Johor, Malaysia
syazwani.asharuddin@gmail.com

Highlights: The combination use of alum and the cassava peel starch has effectively reduced 50% of alum dosage with superior turbidity and TSS removal and speed up sedimentation of flocs 6 times faster compared to treatment using alum alone. The favourable functionality of the bioflocculant is expected to reduce required dosage of chemical coagulants and minimize the operational cost in water treatment plants.

Key words: *cassava peel starch, bioflocculant, dual coagulant, coagulation, flocculation*

Introduction

In line with emerging awareness on the health effect carried by chemical coagulants, intense focus has been given towards natural polymer-based flocculants. Partial substitution of chemical coagulants with natural polymer-based coagulants would certainly decrease aluminium residue in treated water (Mohd Asharuddin et al., 2019).

Recently, flocculants derived from starch precursor have received limelight in the field of water treatment due to their significant advantages of widespread availability, low cost, environmental friendliness, and biodegradability. Unlike most existing starch-based flocculants originated either from sago, maize, wheat, barley, yam or potatoes, cassava peel starch is not predestined for food chain, neither human nor animal, thus it does not cause any food securities worries (Mohd Asharuddin et al., 2021). At the same time, in the realm of food industries waste management, harnessing underutilized cassava peel starch could contribute towards cassava waste agronomical valorization, apart from the enormous advantages and versatility that the starch-based biopolymer itself has to offer (Mohd Asharuddin et al., 2018).

The simple starch extraction method employed in the current requires no further purification and isolation processes which could be both cost and time effective and beneficial to the commercialization aspect. In contrast to many commercial modified starch-based flocculants, the biopolymer produced by the present research contains no toxic and carcinogenic grafting monomers such as acrylamide, dimethylamine and epichlorohydrin, thus is an ecological and safe choice.

Cassava peel starch could be the solution when renewable, natural base raw material is preferred. Suffice to say, cassava peel starch bears immense untapped potential to be further developed as a novel biopolymer surrogate for synthetic polymers for surface and wastewater treatment in light of its ubiquity and substantial economical, environment and commercial values.

Content

Description of innovation



Cassava peel starch (CPS) bioflocculant is developed from agricultural waste precursors towards a dual function water treatment agent. The CPS is synthesized through a green method which avoiding the usage of carcinogenic monomers. Integrated use of alum and CPS demonstrated to shorten the settling time 6 times faster (10 minutes) compared to sole use of alum (60 minutes) with reduction of 50% of alum dosage. The high molecular weight (~68 Mda) of CPS facilitate in faster flocs sedimentation. Surface elemental composition which includes Na, Mg, Si and Ca enhanced the colloidal particle binding. OH groups are found in abundant in the act as proton donor which contribute to the attraction of negatively charged water impurities.

Background of the innovation

Numerous research outputs have been reported due to the local availability and continuous supply by cassava processing industries as well as consistent quality and characteristics. Hitherto, no attempt has been made to avail cassava peel starch as a natural flocculant for surface and wastewater treatment.

Why are they important to education?

Knowledge in Industrial waste upcycling provides students with the knowledge to reduce waste by using waste materials as raw materials which ultimately, reduces pollution. In water treatment engineering perspective, it is important that the community are reminded on the impact of human activities and the effect of usage of chemicals towards the environment so that they can act sustainably in preserving it.

Advantages of your innovation towards education and community.

Sustainable and greener solution for water treatment problems is the persistent need in the current days. The present innovation could be a feasible water treatment agent to complement alum coagulation ability in removing suspended solids in raw water, reduces alum effective dosage as well as speed up sedimentation. The incorporation of CPS bioflocculant, the operational time and cost is expectable to be evidently reduced in water treatment plants. The production of CPS facilitates industrial waste valorization and reduce the generation of concentrated metal-laden sludge from water treatment plant.

Commercial value in terms of marketability or profitability of the innovation

The preparation of CPS is advantageous over other natural coagulants as it requires no further purification and isolation processes which could be both time and economically challenged.

Promotes reduction of waste generation by local food industries - average cassava peel waste generation by food processing industry in Parit Raja = 0.24 tonnes/week/premise.

Producing biodegradable sludge which reduce scheduled waste and sludge disposal cost - combination treatment using alum-CPS reduce up to 50% of alum dosage

Cost effective

Example for latex processing wastewater treatment (Loh, 2002):

Glove processing industry	Effluent generated (m3/day)	*Cost of coagulation treatment using commercial coagulant	*CPS (present work)
A	1660	RM 0.25/m ³	RM 0.0037/m ³
B	1000	RM 0.042/m ³	
C	1200	RM 0.16/m ³	

*Based on average initial TSS of 100 mg/L.

Acknowledgement

The present work is funded by the Prototype Research Grant Scheme (PRGS 2.0 – K345) supported by the Ministry of Higher Education (MOHE), Malaysia and Research Management Centre of UTHM.

References

- Loh, L.K. (2002). Dissertation (M.Tech. (Envir. Mgmt.) - Institut Pengajian Siswazah dan Penyelidikan, Universiti Malaya.
- Mohd Asharuddin, S., Othman, N., Alfoqayti, W.A.H., Bakar, N.A. & Hassan, A. (2021). Recent advancement in starch modification and its application as water treatment agent. *Environmental Technology & Innovation*, 101637.
- Mohd Asharuddin, S., Othman, N., Zin, N.S.M., Tajarudin, H.A. & Din, M.F.M. (2019). Flocculation and antibacterial performance of dual coagulant system of modified cassava peel starch and alum. *Journal of Water Process Engineering* 31, 100888.
- Mohd Asharuddin, S., Othman, N., Mohd-Zin, N.S. & Tajarudin, H.A. (2018). Removal of total suspended solid by natural coagulant derived from cassava peel waste. *Journal of Physics: Conference Series* 995 (1), 012040

DESIGN OF DOORiage FOR CARRYING AND INSTALLING DOORS

Mohd Fadly Bin Abdullah

Polytechnic of Kota Bharu, Kota Bharu, Kelantan
fadlypkb@gmail.com

Wan Nur Aqilah Binti Wan Nawang, Mohd Sobri Bin Hassan

Polytechnic of Kota Bharu, Kota Bharu, Kelantan
wannuraqilah1999@gmail.com, sobri.hassan@pkb.edu.my

Highlights: Dooriage tools can help to carry and install doors more quickly and save energy manpower. Bringing the door, respondents gave a score mean of 4.2 which is at a high level. Installing the door also gives a score mean at the high level of 4.2. Other features available on the Dooriage also support that this tool is indeed helpful in speeding up the process of carrying and installing the door.

Key Words: door, install door, carry door, Dooriage.

Introduction

The development of construction sector in Malaysia continues to increase. This is due to the high demand for the construction of government buildings, private buildings, business premises buildings, housing and so on which lead to the progress of the country. The construction of new building requires good coordination to speed up the construction process. There are many technologies and tools created to reduce manpower, speed up the work process and also to reduce its manufacturing costs. According to Astro Awani on 25 September 2016, the use of technology can help dependence on foreign workers. So, the use of this technology can be used in construction and researchers focus on door.

The door serves as the entrance and exit of a building. Door installation nowadays uses a lot of conventional methods that require two people of labor and takes quite a long time. Therefore, Dooriage tools are created to help ease the process of carrying and installing doors.

Product Development, Design and Process

This Dooriage is designed to speed up the process of carrying and installing doors. The initial design of this tool was made on drawing paper, then prototype using a paper box. After researching and making improvements on the prototype, the real tool is made using iron.

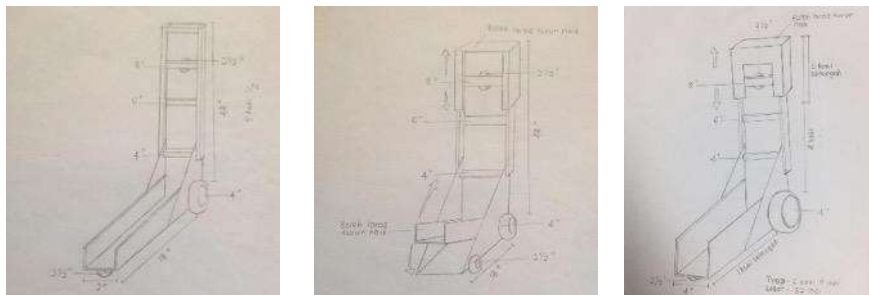

Diagram 1: Three initial design of Dooriage



Diagram 2: Prototype using paper box



Diagram 3: The end of product - Dooriage

Importance and advantages of this Dooriage tool are save manpower, saves time and simplify the installation of the door. Besides that, it's provided a consistent distance between the floor and the door. Dooriage tool also safe to use to carry the door and easy to store because it can be shortened.

Result

5 Likert scale was used in this study which was adapted from Mohd Najib (1999). Then it is translated to scores mean for analysis purposes. Here are the results that have been obtained.

Table 1: Score mean and level of Dooriage tool to bring the door

No	Item	Score mean	Level
1	Able to facilitate work while carrying the door	4.5	High
2	Easy to control while operating this tool	4.7	High
3	This design is suitable for carrying doors	4.2	High
4	Can accommodate door loads well	4.3	High
5	Able to save time while carrying the door	4.6	High
6	Smooth movement and good moving wheels	4.3	High
7	Suitable for carrying all types of doors	2.9	Moderate
	Average	4.2	High

Table 2: Score mean and level of Dooriage tool to install the door

No	Item	Score mean	Level
1	Saves time to install the door	4.6	High
2	Saves manpower to install the door	4.8	High
3	The door is in a fixed position and does not sway while installing the door	4.1	High
4	All types of doors are suitable	4.6	High
5	The tool is easy to operate during door installation	4.4	High
6	The fire lock works well	4.1	High
7	Suitable for installing all types of doors	2.9	Moderate
	Average	4.2	High

Table 3: Score mean and level of Dooriage for other features

No	Item	Score mean	Level
1	Lightweight to carry	3.1	Moderate
2	Has high durability	4.2	High
3	The design is in line with its function	4.4	High
4	Safe to use for carrying and installing doors	4.5	High
5	Easy to store after use	4.5	High
6	Durable to do any work	4.2	High
	Average	4.2	High

Overall, this Dooriage tool can help carry and install doors more easily and effectively by giving a score mean at a high level.

Discussion

Dooriage tools can help to better carry and install doors. Based on feedback from respondents. This Dooriage helps to bring the door by giving a score mean at a high level of 4.2. However, there are items that give a moderate score mean for example this tool is suitable for carrying all types of doors. So here, this Dooriage tool is not suitable for carrying all types of doors and it is only suitable for carrying standard sized of doors.

In terms of installing the door, this Dooriage gives a high score mean value of 4.2. This tool item is suitable for installing all types of doors giving a moderate score mean value of 2.9. Other features also gave a high score value except that lightweight to carry gave a moderate score mean of 3.1. This Dooriage is quite heavy and can be improved by using lighter aluminum or iron in the future.

Acknowledgement

The researcher would like to thank the Kota Bharu Polytechnic for helping to provide moral support and willing to provide the facilities available at PKB to complete this project

References

- Mohd Najib (1999). Penyelidikan Pendidikan. Universiti Teknologi Malaysia.
 Penggunaan teknologi bantu kurang kebergantungan terhadap pekerja asing. (2016, September 25). Astro Awani.
<https://www.astroawani.com/berita-malaysia/penggunaan-teknologi-bantu-kurang-kebergantungan-terhadap-pekerja-asing-mbam-117613>



CRI 2021

CARNIVAL OF RESEARCH AND INNOVATION
VIRTUAL INTERNATIONAL EDITION

PART 2
SOCIAL SCIENCE

VIRTUAL EARLY MATHEMATICS LEARNING KIT FOR ADDRESSING THE AMBIGUITY OF MATHEMATICAL PROCEDURAL SKILLS AND TERMINOLOGIES

Prof. Madya Dr. Anida Sarudin

Universiti Pendidikan Sultan Idris, 35900, Tg. Malim, Perak
anida@fbk.upsi.edu.my

Dr. Husna Faredza Mohamed Redzwan, Dr. Wan Mazlini Othman, Prof. Madya Dr. Zulkifli Osman, Prof. Madya Raja Noor Farah Azura Raja Ma'mur Shah, Prof. Madya Dr. Intan Safinas Mohd Ariff Albakri, Dr. Siti Rahaimah Ali, Muhammad Nazrin Abu Bakar

Universiti Pendidikan Sultan Idris, 35900, Tg. Malim, Perak
husna.faredza@fbk.upsi.edu.my, wan.mazlini@fbk.upsi.edu.my, zulkifli@fbk.upsi.edu.my,
raja_farah@fmsmt.upsi.edu.my, safinas@fbk.upsi.edu.my, siti.ahaimah@fbk.upsi.edu.my, muhd.nazrin1709@gmail.com

Highlights: This product aims to measure the 4-year-old preschool children in their understanding about operations or procedural skills and early Mathematics terminology. It offers a lexical approach based on the Semantic Prosody Theory that explains the early Mathematical procedural and terminology skills. This product is named as OpTeKoM Kit which is an acronym for Mathematical Operations, Terminology and Context Kit. One of the strengths of this product is that it provides innovation in the early teaching of Mathematics related to the concepts of matching, collecting, isolating and comparing. This product highlights the medium of language in translating the operations and early terminology of Mathematics applied contextually or multicontextually meaningfully. In this product, the teaching context means incarnated through research-based approach by the corpus from Dewan Bahasa dan Pustaka Databases (DBP) to examine the collocation of the concepts of matching, collecting, isolating and comparing. Thus, this developed innovation reveals an early Mathematics learning kit based on a fun online lexical approach while cultivating thinking skills through lexical context.

Key words: *OpTeKom Kit, corpus, procedural skills; terminology; Early Mathematics*

Introduction

The failure of children in mastering the concepts and skills of Mathematics will constrain the fostering of interests in such learning which indirectly becomes an obstacle in achieving the aspirations of education as a whole and the aspirations of individual students as outlined in the National Education Development Plan (2013-2025). A study by Zakiah Mohamad Ashari et al. (2013) who discovered that the verbal strategies often used by teachers were more towards general understanding and did not highlight the information contained in the Mathematics terminology itself. In addition, the phrase comprehension strategies used by teachers are more towards general understanding and do not highlight information to students related to subjects, instructions and keywords in the teaching of Verbal Mathematics. This has caused the process of understanding Mathematical terms complicated among students and indirectly created ambiguity in understanding Mathematical terminology and procedural skills (Aiken, 1972; Bley Vroman, 1989; Bradby et al., 2002; Bryant).

The use of language in the learning and facilitation of early Mathematics will become clearer if it is accompanied by an efficient theory or model of language to address ambiguity in understanding the concepts according to the terminology and procedures of early Mathematics relationally. Constraints in terms of the verbal language used by preschool teachers in the early teaching and learning of Mathematics are translated through the failure of teachers to use inaccurate terminology in describing terminology and procedures in this area. This conflict has caused the understanding of a Mathematical concept and the procedural skills taught to be more complex as students find it difficult to figure out the meaning of terms and constructs in Mathematical operations.

Based on this view, this study utilizes the language aspect as a solution indicator in addressing the ambiguity of procedural skills and early terminology of Mathematics through Semantic Prosody Theory (Firth, 1957), Louw (1993). This theory is a lexical examination methodology looking at the existence context or combination of words that reflect a particular meaning and highlight a consistent aura of meaning. Utilization of Semantic Prosody Theory in this study is conducted through collocation analysis of the corpus (data obtained from the Corpus Database of Dewan Bahasa dan Pustaka DBP) related to the lexical meaning of match/matching, collecting, isolating and comparing. The Corpus data is real data of the Malay language users and indicates the context of real use of the language by the speakers. Therefore, the details of collocation from this corpus data will be examined in context to understand the meaning of the lexical as well as examine the lexical value. The results of the lexical meaning will determine the context and meaning related to the concepts of matching, collecting, isolating and comparing (Sarudin, A et al., 2019a, 2019b). Analysis also shows that lexical values are often positive when the words (match/match, collect, isolate and compare) collocate with words of positive value. The language patterns found in the corpus data can express the meaning exactly as it is carried by the speaker.

Through the integration of these four elements, learning and facilitation by teachers and children can be implemented effectively. This consistent verbal principle makes learning and facilitation by early childhood educators and early childhood procedural skills and early terminology of Mathematics more meaningful by emphasizing several processes, namely (1) Choice of words or lexicons used by teachers and children in teaching procedural skills and Mathematical terminology (2) Functions of words (3) Purpose of communication that reflects the nature of words in highlighting early mathematical procedures and terminology skills. From the point of view of analysing language using this theory, Mathematics should be deeply appreciated in terms of meaning in the concept presented by teachers focusing on the multicontext paradigm applied in this study through (1) Enrichment of knowledge, (2) Creative thinking, (3) semantics and pragmatics approach and (4) Self -motivation.

The study involved 20 teachers and 60 4 -year -old children. A total of 4 early childhood schools located in Perak involved in this study. The instruments used in this study were questionnaires and observation and facilitation checklists (PdPc).The PdPc observation process involved only 8 randomly selected teachers. This study also applied the corpus from the Dewan Bahasa dan Pustaka (DBP) Database to examine word collocation and lexical related context of matching, collecting, isolating and comparing, based on the findings of the analysis and conflicts observed in the early PdPc of Mathematics. This study has developed a virtual kit named the OpTeKoM Kit. This virtual kit used the medium of language in translating the operations and early terminology of Mathematics that is applied in meaningful contexts or multicontexts.In this product, the meaningful teaching context is created through a research-based approach to Malay lexis corpus that provides collocation of words and a clear concept of early mathematics. This process provides an understanding of the concepts of matching, collecting, isolate and isolating in a meaningful way and can be utilized by teachers as an effective and innovative learning aid (BBB).The OpTeKoM kit highlights the cognitive, psychomotor and affective abilities of children as well applying more efficient teaching methods in the teaching of verbal Mathematics. This kit visually highlights the information contained in the early terminology of Mathematics. This product is the best product and fulfills the learning features of the 21st century because it is applied in the form of interactive, creative and innovative online OpTeKoM Kit software that can be accessed through the OpTeKoM Kit pin card. See the link developed of this product: <https://scratch.mit.edu/projects/313663914>

Conclusion

Based on the observations of the collocations for the words match, matching, collect, isolating and comparing, it is evident that the teaching of early Mathematics for the concepts should be transparent and accurate. This is aimed to enable children to have good understanding of the procedural skills and terminology for the concepts. In other words, the teaching of early Mathematics should be characterized by the construction of concepts and comprehensive meanings of its nature.

Figure 1: Corpus from Database Corpus DBP

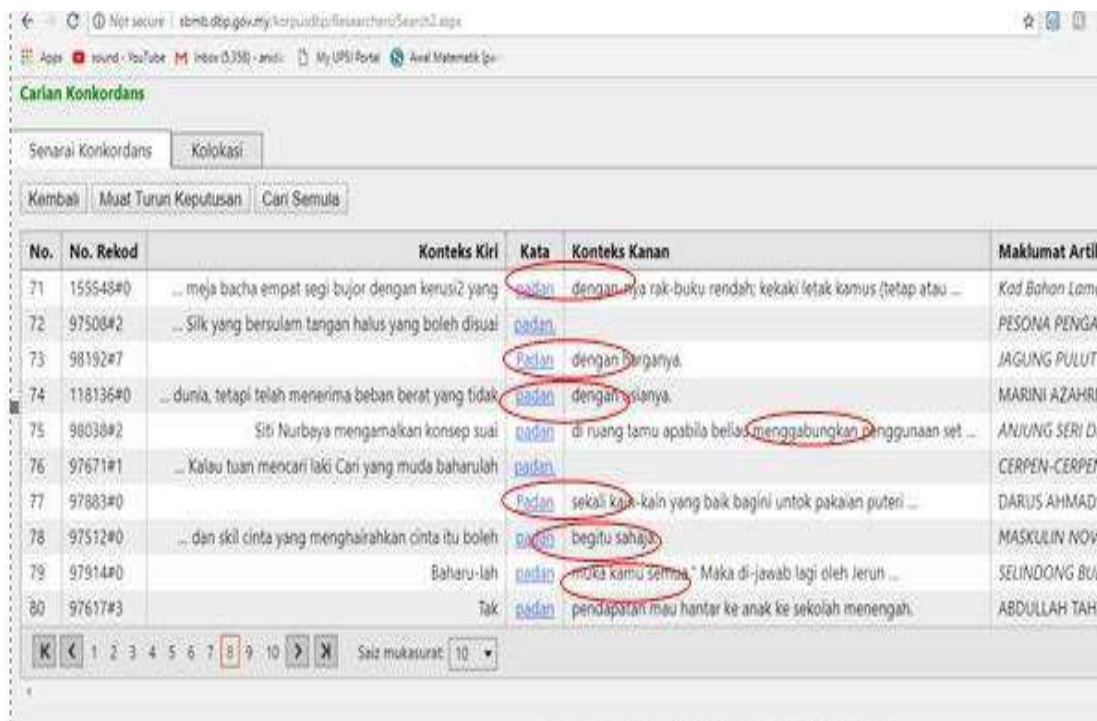

No.	No. Rekod	Konteks Kiri	Kata	Konteks Kanan	Maklumat Artikel
71	155548#0	... meja bache empat segi bujur dengan kerusi2 yang	padan	dengan meja rak-buku rendah; kekaki letak kamus (tetap atau ...	Kad Bahan Lama
72	97508#2	... Silk yang bersulam tangan halus yang boleh disusi	padan		PESONA PENGAI
73	98192#7		padan	dengan barangnya.	JAGUNG PULUT I
74	118136#0	... dunia, tetapi telah menerima beban berat yang tidak	padan	dengan nilainya.	MARINI AZAHRI,
75	98038#2	Siti Nurbaya mengamalkan konsep suai	padan	di ruang tamu apabila beliau menggabungkan penggunaan set ...	ANJUNG SERI DI
76	97671#1	... Kalau tuan mencari laki Cari yang muda baharulah	padan		CERPEN-CERPEN
77	97883#0		padan	sekali kain-kain yang baik bagini untuk pakaian puteri ...	DARUS AHMAD,
78	97512#0	... dan skil cinta yang menghairahkan cinta itu boleh	padan	begitu sahaja.	MASKULIN NOVI
79	97914#0	Baharu-lah	padan	maka kamu semua. Maka di-jawab lagi oleh Jeruh ...	SELINDONG BUL
80	97617#3	Tak	padan	pendapatan mau hantar ke anak ke sekolah menengah.	ABDULLAH TAHII

Acknowledgement

Appreciation to RMIC, UPSI for granting the University Research Grant (GPU) 2017 0228 107 01 entitled *Development of Lexical Kits to Overcome the Ambiguity of Procedural Skills and Early Terminology of Mathematics Among Children*.

References

- Aiken, L.R Jr. (1973). Ability and Creativity in Mathematics. Columbus, Ohio:ERIC Information Center.
- Bley-Vroman. (1989). *What is the logical of Foreign Language Learning* in Susan M.Guss, Jacquelyn Schachter. Linguistic Perspective on Second Language Acquisition. Cambridge University Press. New York.
- Bradby, D., Owings, J., & Quinn, P. (1992). Language characteristics and academic achievement: A look at Asian and Hispanic eighth graders in NELS: 88. *Statistical Analysis Report*. Berkeley: MPR Associates. (ED 343 971).
- Bryant, P., & Nunes, T. (2002). Children's understanding of mathematics. In U. Goswami (Ed.), *Blackwell handbook of childhood cognitive development* (pp. 412–439). Malden, The Netherlands: Blackwell.
- Clements, D. H., & Sarama, J. (2007). Effects of a preschool Mathematics curriculum: Summative research on the Building Blocks project. *Journal for Research in Mathematics Education*, 38 (2), 136-163.
- Kamus Dewan (ed. Ke-4). (2007). Kuala Lumpur: Dewan Bahasa dan Pustaka.
- Sarudin, A., Raja Ma'amor Syah, R. N. F. A., Mohamed Redzwan, H. F., Osman, Z., Othman, W. M., Mohd Ariff Albakri, I.S. (2019a). Lexical Approach: Overcoming Vague Skills Procedure and Early Mathematical Terminology based on the Prosodic Semantic Theory. *Journal of Mechanics of Continua and Mathematical Sciences*, 14 (3), 94-111.
- Sarudin, A., Mohamed Redzwan, H. F., Osman, Z., Raja Ma'amor Shah, R. N. F., & Mohd Ariff Albakri, I. S. (2019b). Menangani kekaburan kemahiran prosedur dan terminologi awal Matematik: Pendekatan leksis berdasarkan Teori Prosodi Semantik. *Malaysian Journal of Learning and Instruction*, 16(2), pp. 255- 294
- Zakiah Mohamad Ashari, Azlina Mohd. Kosnin, Yeo Kee Jiar (2013). Keberkesanan Modul Belajar Melalui Bermain Terhadap Kefahaman Pengalaman Pranombor Kanak-kanak Prasekolah. *Prosiding 2nd International Seminar on Quality and Affordable Education (ISQAE) 2013*.Kuala Lumpur.

AR OF BRITISH PILLBOX AS A MEDIUM IN EDUCATION THROUGH THE TOURISM SECTOR FOR YOUNG GENERATIONS

Nur Athmar Binti Hashim

Universiti Malaysia Kelantan, Bachok, Kelantan
athmar.h@umk.edu.my

Dr. Tengku Fauzan Tengku Anuar, Dr Siti Aisyah Muhammad, Nur Farhana Bt Shuhaimi

Universiti Malaysia Kelantan, Bachok, Kelantan
tengkufauzan@umk.edu.my, aisyah@umk.edu.my, hannashuhaimi969@gmail.com

Highlights: The development of the Augmented Reality (AR) application will be used as an effort to preserve the British pillbox monument in Kelantan for the heritage tourism industry and at the same time will become an educational medium to the younger generations. This method aims to foster awareness country's history in the young generations. With the preservation of the British pillbox in Kelantan through the Augmented Reality (AR) technology, it is seen to have a more effective impact in line with the 4th Industrial Revolution (4IR).

Key words: *Augmented Reality, Conservation, Heritage Tourism, Pillbox, Kelantan*

Introduction

The development of the Augmented Reality (AR) application will be used as an effort to preserve the British pillbox monument in Kelantan for the heritage tourism industry and at the same time will become an educational medium to the younger generations. This method aims to foster awareness country's history in the young generations. With the preservation of the British pillbox in Kelantan through the Augmented Reality (AR) technology, it is seen to have a more effective impact in line with the 4th Industrial Revolution (4IR). Furthermore, virtual heritage tourism needs to be proposed to various aspects such as education, economy, and safety of the Covid-19 pandemic. The information on the pillbox will apply an easy-to-understand approach especially in heritage tourism which is also considered an educational material to the next generations.

According to researchers, the British pillboxes, located on the coast, suffered from a lot of damage, including waves, and efforts to preserve them cannot be carried out effectively caused of the lack of technology. With this method, the development of Augmented Reality is expected to make the monument remain and does not disappear.

Content

Problems Statement

The problem that can be stated is almost all British pillbox in Kelantan suffer from problems such as deterioration of the effects of waves and coastal erosion, and vandalism. Other than that, the parties involved are unable to carry out the preservation because the location of the pillbox is in areas at risk of experiencing threats such as wave erosion. Lastly, lack of technology resources for conservation work.

Questions

In order to meet the objectives of the study, researchers have formulated some research questions:

- i) What is the effect of the use of the Augmented Reality (AR) of the British pillboxes for the younger generation through the context of heritage tourism?
- ii) How is the potential of virtual tourism to the tourism sector?

Objective

This research refers to some objectives:

- i) Review the effectiveness of the Augmented Application Augmented Reality of British pillboxes for the younger generations through the context of heritage tourism.
- ii) Analyze the potential of virtual tourism to the tourism sector.

Methodology

To produce Augmented Reality (AR) for British pillboxes in Kelantan, researchers will collect data about pillboxes in Kelantan, the way how to conserve them, and also the importance of the history of pillboxes. Next, the information will be created in video and prepare for Augmented Reality using the application in google play store and apple app store so that the user mostly the new generation can download and use the application.

AR Method (step by step) :



Figure 14 : An Album for British Pillbox

Step 1: Create an album for single British pillbox structure.



Figure 15: An Album for British Pillbox

Step 2: Select all the picture that provided, then click create, choose video.



Figure 16: Soloop application for video creator

Step 3: Import all image selected into SOLOOP application, edit and choose the best effects for the video, then click finish.



Figure 17: Soloop application for video creator

Step 4 : After click the finish button, the video is ready to generate by click Generate button on top right in yellow column.



Figure 18: Soloop application for video creator

Step 5 : Wait for a while, then after finish generate, the video ready to use.

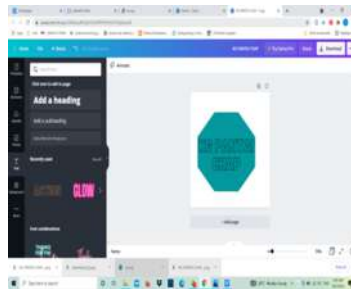

Figure 19: Canva. Com page

Step 6 : By using Canva.com, create marker for AR scanner.



Figure 20: Unite AR page

Step 7 : Sign in to Unite AR, upload the image for marker.

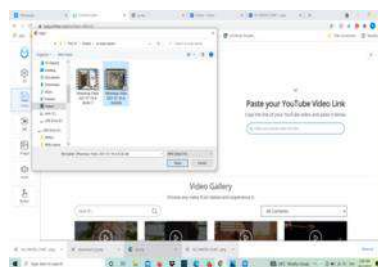

Figure 21: Unite AR page

Step 8 :Then choose the video for content.

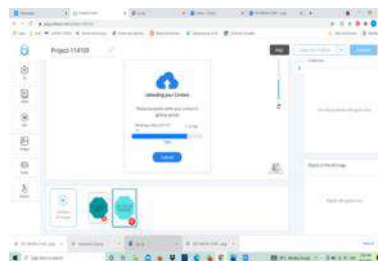

Figure 22: Unite AR page

Step 9 : Browse and upload the video from desktop.

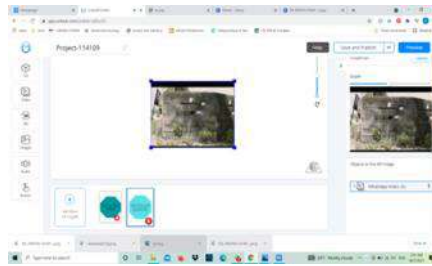

Figure 23: Unite AR page

Step 10 : Wait until the video ready to preview.



Figure 24: Unite AR page

Step 11 : Preview the AR with content to make sure the project succesful.

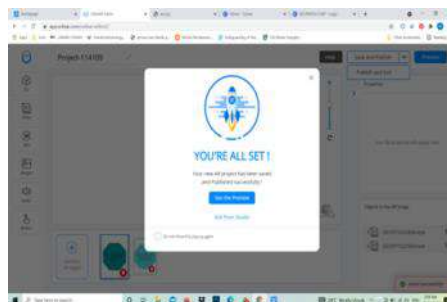

Figure 25: Unite AR page

Step 12 : Download the QR and image for AR scanner, then save and publish the project.



Figure 26: AR marker

Step 13 : Download Unite AR through the phone and the QR code is ready to scan.

Acknowledgment

We are grateful for the RMIC, Universiti Malaysia Kelantan through the Long Term Grant (FRGS) titled Characterization of British Pillboxes Buildings Structure In Kelantan For Conservation (R/FRGS/A0200/01079A/002/2020/00898).

References

- Kamus Dewan Bahasa Dan Pustaka Edisi Keempat , 2007.Selangor : Dewan Bahasa Dan Pustaka.
- Nik Mohamed B Nik Mohd. Salleh (1995). Warisan Kelantan. Kota Bharu, Kelantan : Perbadanan Muzium Negeri Kelantan.
- Kelab Pencinta Sejarah Kelantan (2015). Pantai Sabak Terakam Dalam World War 2. Dicapai pada Januari 6, 2021 daripada <https://sejarahkelantan.wordpress.com/tag/British/>
- Nurul Izzati Othman (2017). Kubu Kebal, Kota Bharu. Dicapai pada Januari 5, 2021 daripada flickr.com/photo/15515567@no8/37570255700
- Lokman Ismail (2018). Kubu Kebal Sejarah Perang Dunia Kedua. Dicapai pada Januari 5, 2021 daripada <http://bicaramentari.blogspot.com//2018/10/bqa.html?m=1>
- Yoga Aprillion Saputra. (2014). Implimentasi Augmented Reality (AR) Pada Fosil Purbakala Di Museum Geologi Bandung.Komputer Dan Informatika (KOMPUTA), 1 (01), 1-8.

PROGRAMMING TRAINER KIDS (ProKiDs)

Chung Boon Chuan

Politeknik Kota Bharu, Kelantan
Chungpkb2011@gmail.com

Nik Rahaya binti Nik Ishak, Nur Filzah Binti Mohd Fauzey

Politeknik Kota Bharu, Kelantan
nikrahaya@gmail.com, filzah@pkb.edu.my

Highlights: The Basic Programming Course is a compulsory course taken by students of the Department of Electrical Engineering in second semester of study at the Malaysian polytechnic. Courses that expose students to the basic techniques of programming are considered difficult by most of students, especially students at JKE PKB. This negative perception caused many of them to become not interested in studying this course. A new Trainer, ProKiDs (Programming Trainer Kids) has been designed to help students understand the theory and practice of the Programming course in one complete trainer package. Learning programming for electrical engineering students is something that is difficult to understand because the operation of the program cannot be seen like other courses. In fact it requires students to imagine the operating process of the program. Even for this course no special trainer has been produced yet. Existing learning methods are more to theory and program output, students write programs, compile and execute to view the resulting output on a computer display. There is no application to the hardware that allows students to understand the process and the actual use of the program produced. This ProKiDs Trainer is apply the Design Thinking Model method, involves in 5 proses which is Empathize, Define, Ideate, Prototype and Test. The innovation of ProKiDs involves two new inventions, namely practical modules and learning modules that innovate in packages. This creative trainer involves meet and match puzzle modules to produce a variety of controls that are controlled by the program. Students only need to take and install the relevant modules, and create a program based on the module notes provided and be able to generate the desired output. These modules can be added from time to time as needed without changing the functionality of these ProKiDs. The materials used are durable and easy to use, consisting of a package of control modules, inputs, outputs, program tools, module notes and a trainer box. The result is a trainer tool for complete programming and it can also increase students' understanding of the concept of programming and control, further increasing the interest of students to study this course.

Key words: *programming, trainer, design thinking, empathize, define, ideate prototype, test.*

Introduction

The Basic Programming Course is a compulsory course taken by students of the Department of Electrical Engineering in second semester of study at the Malaysian polytechnic. Courses that expose students to the basic techniques of programming are considered difficult by most of students, especially students at JKE PKB. This negative perception caused many of them to become not interested in studying this course. Learning programming for electrical engineering students is something difficult to understand because the operation of the program cannot be seen like other courses. In fact, it requires students to imagine the operating process of the program. Even for this course no special trainer has been produced yet. Existing learning methods are more to theory and program output, students write programs, compile and execute to view the resulting output on a computer display. There is no application to the hardware that allows students to understand the process and the actual use of the program produced.

Novelty & Inventiveness

The materials used are durable and easy to use, consists of a package of control modules, inputs modules, outputs modules, program tools, module notes and a trainer box. The innovation of ProKiDs involves two new inventions, namely practical modules and learning modules that innovate in packages. This creative trainer involves meet and match puzzle modules to produce a variety of program -controlled controls. Students only need to take and install the relevant modules, and create a program based on the module notes provided and be able to generate the desired output. These modules can be added from time to time as needed without changing the functionality of ProKiDs. The cost RM20.00 for each module and the ProKiDs box set costs RM150.00.

Innovation / Product development / Design / Process

Design Thinking: This innovation is apply the Design Thinking as problem solving approach and involving five phases—Empathize, Define, Ideate, Prototype and Test. It is a contemporary approach that is human-centric. It focuses on the client's requirements and needs, which is essential in the innovation for delivery of services.

Empati : This is based on the five-stage Design Thinking process. At this stage, the researchers try to be empathic in order to understand the Programming language learners at Kota Bharu Polytechnic, their needs and problems that they face.

Bil	Method	Description
1.	Observe	Make observations while students carry out practical work for the fundamental Programming course in the Programming laboratory
2.	Engage in practical work	Group members have also tried to do the practical work process to find out the problems faced by students while doing practical work in the laboratory (Appendix 3.1.2b) carry out practical work for the fundamental Programming course in the Programming laboratory
3.	Interviews	Interviews of students and course lecturers were conducted and information was recorded for analysis.
4.	Questionnaire	Questionnaires were also conducted to collect information from students and lecturers involved

Defining the problem: At this stage, the researchers analyse the information that they have gathered and synthesise them so that they can identify and define the problem in a human-centred way. The researchers also discuss ideas to solve these problems.

Interesting Information	Data	Discovery	We Want to Help
Take Time	Engage in practical work	they state that the connection wire (jumper wire) is always broken and it is difficult to make sure the connection is right or wrong. If found wrong, it is necessary to reconnect, causing a lot of time wasted	connection wire that is not easily broken and easy to make connections
Wire jumper is always broken	Observe	From observations, the wires used when connecting circuits are often broken	Need a durable extension wire
fibrous wire connection	Interviews	numerous jumper wires need to be used to make circuit connections	reduce the use of jumper wires
Error while making circuit connection	Questionnaire	Students often make mistakes in the required circuit connections	simple circuit connection

Ideate : As a result of generating creative ideas, group members agreed to create a Programming Trainer Kids(ProKids) that could solve related problems. Taking into account low cost, fast implementation, high impact and sustainability. SWOT analysis is used to complete the recommendations that have been made, the results of the trainer build team members by producing a prototype first.

Prototype: Group members have produced the first prototype and improved on the second prototypes which is better and more appropriate. In addition, the group has produced a complete set of components to facilitate the testing process.

Test : Testing and implementation were conducted in a Programming laboratory, Department of Electrical Engineering, Kota Bharu Polytechnic, to collect data and evaluate the effectiveness of the project. The main components in the Programming Trainer Kids(ProKids) are shown below :

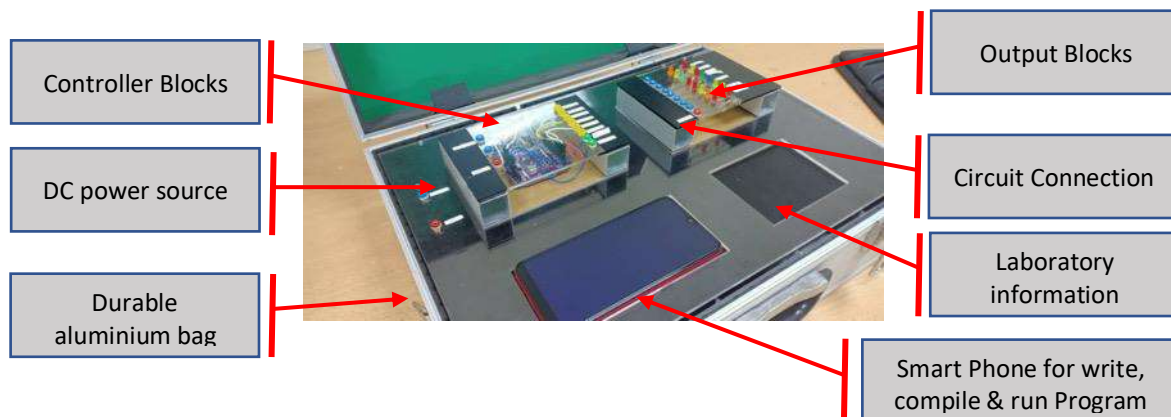

Background of the innovation

Creative new ideas are translated through the production of innovative projects that benefit the organization and customers (students). It gives a positive impact to Organization - Improving the efficiency and effectiveness of service delivery. Positive impact on the Customers (students) - meet service needs and meet customer expectations. Save practical work time by producing user-friendly innovations. Reduce errors through methods and materials produced. Cost savings through optimization of the use of existing resources. This project has the potential to be adapted directly or modified according to the needs of other organizations. The replication agenda has been taken into account from the project revenue stage as a way to achieve the goal of replication. We also consider the commercialization agenda at the project production stage as an initial step in expanding the potential of the project by making declarations and copyright.

Importance to education

Creativity and innovation: The idea for this project is based on creativity which is translated into an innovation that benefits the end users, namely the students. **High impact:** Clients (students) – fulfils clients' expectations to improve their Programming language theory and practical. **Excellent value return:** Saves time through user-friendly innovation. Eliminates mistakes through the structure of the trainer. Saves cost because the project does not require the use of expensive-high end materials. It is very flexible and can be used by students in all levels of proficiency.

Advantages of your innovation

Consists of a complete package of control modules, inputs, outputs, programming tools, module notes and a trainer box with an interesting meet and match puzzle module concept. It is able to increase students' understanding of programming concepts more easily. Students can use the tool without complete assistance from the lecturer as all the notes and manuals are already available. The materials used are easy to carry anywhere and durable.

Commercial value /marketability /profitability

This innovation project is not only suitable for use in the Department of Electrical Engineering, Kota Bharu Polytechnic but also for all Malaysian polytechnics (33 polytechnics and Malaysian Community Colleges (79 Malaysian Community Colleges). This project can also be applied in IPTA and IPTS in the field of Electrical Engineering or computer science for Programming Language. This project also has the potential to be commercialized for all educational institutions either locally or international

Intellectual Property



References

- Matthews J. (2013). Design Thinking and Management Education: Benefits for Problem Framing and Problem Solving
- Serrat O (2010). Design Thinking
- Matthews, J., & Wrigley, C. (2017). Design and Design Thinking in Business and Management Higher Education

PROGRAMMING EDUCATION CARDS GAME (PECgame)

Chung Boon Chuan

Politeknik Kota Bharu, Kelantan, Malaysia
bchuan@pkb.edu.my

Melissa Khor Suan Chin, Udom A/L Ewon

Politeknik Kota Bharu, Kelantan, Malaysia
melissa@pkb.edu.my, udom@pkb.edu.my

Highlights: The Basic Programming Course is a compulsory course that must be taken by students from the Department of Electrical Engineering during their second semester of study at the Malaysian polytechnics. Courses that expose students to the basic techniques of programming are considered difficult by most of the students. This negative perception caused many of them to lose interest in pursuing this course. A new method called PECgame (Programming Education Cards game) has been designed to help students understand the theory and application of the Programming course in one complete game package. Furthermore, no special game has been produced yet. The existing learning methods are more to theory, structure, program writing, compile and execute to view the output on a computer display. This game allows students to play while understanding the actual process for this Programming Fundamental course.

Key words: *PECgame, Design Thinking, Cognitive Domain, Affective Domain, Psychomotor Domain, Theory Module Package.*

Introduction

The Basic Programming Course is a compulsory course that must be taken by students from the Department of Electrical Engineering during their second semester of study at the Malaysian polytechnics. Courses that expose students to the basic techniques of programming are considered difficult by most of the students. This negative perception caused many of them to lose interest in pursuing this course. Lack of interest and skill causes them to fail in the programming courses (Neil and Amjad, 2014).

Learning programming is considered as something that is difficult to understand and remember by the electrical engineering students because the program application cannot be seen like other courses. In fact, it requires students to imagine the operating process of the program. Even for this course, no special game has been produced yet. The existing learning methods are more to theory, structure, program writing, compile and execute to view the output on a computer display. Innovations in learning methods need to be used to enable a more effective understanding for this Programming Fundamental Course. Interactive teaching approaches and drills need to be multiplied to facilitate students to be more proficient in program development (Norhayati and Nur Wahidah, 2018).

This PECgame innovation is produced using the Design Thinking Model method, which involves 5 processes namely Empathize, Define, Ideate, Prototype and Test. This PECgame innovation involves new inventions namely games and learning modules that innovate in packages. This creative PECgame involves mix and match cards. The learning process will involve three (3) learning domains namely cognitive domain, affective domain and psychomotor domain. These three domains are essential to be applied in teaching and learning. The cognitive domain aims to develop the mental skills and the acquisition of knowledge for the course. Affective domain includes the feelings, emotions and attitudes while playing game. As for the psychomotor domain, it includes utilizing motor skills and the ability to coordinate them. Students only need to play and learn the modules in the form of a card game, by arranging them based on the module notes and win the game. The player who successfully finish all the cards in his possession will be the winner. These module cards can be added from time to time as needed without changing the functionality of this PECgame. The materials used are durable and easy to use, consisting of a theory module package, program examples, syntax, module notes and keywords. This game can be applied to other courses as learning materials as well. This creative innovation makes learning more fun, challenging and exciting. At the same time, it can test the students' thinking skills and improve their understanding regarding the concept of fundamental programming.

Innovation / Product Development / Design / Process

This PECgame innovation is produced using the Design Thinking Model method, which involves 5 processes namely Empathize, Define, Ideate, Prototype and Test. This PECgame innovation involves new inventions namely games and learning modules that innovate in packages.

This creative PECgame involves mix and match cards. The learning process will involve three (3) learning domains namely cognitive domain, affective domain and psychomotor domain. These three domains are essential to be applied in teaching and learning. The cognitive domain aims to develop the mental skills and the acquisition of knowledge for the course. Affective domain includes the feelings, emotions and attitudes while playing game. As for the psychomotor domain, it includes utilizing motor skills and the ability to coordinate them.

Students only need to play and learn the modules in the form of a card game by arranging them based on the module notes and win the game. The player who successfully finish all the cards in his possession will be the winner. These module cards can be added from time to time as needed without changing the functionality of this PECgame. The materials used are durable and easy to use, consisting of the theory module package, program examples, syntax, module notes and keywords. This game can be applied to other courses as learning materials as well. This creative innovation makes learning more fun, challenging and exciting. At the same time, it can test the students' thinking skills and improve their understanding regarding the concept of fundamental programming.

Background of the Innovation / Product Development / Design / Process

- 1.1. **Design Thinking:** This innovation incorporates the Design Thinking as problem solving approach and involving five phases—Empathize, Define, Ideate, Prototype and Test.
- 1.2. **Empathy:** At this stage, the researchers try to be empathic in order to understand the Programming language learners at Politeknik Kota Bharu, their needs and problems that they face is human-centric. It focuses on the client's requirements and needs, which are essential in the innovation for delivery of services.
- 1.3. **Defining the Problem:** At this stage, the researchers analyse the information that they have gathered and synthesise them so that they can identify and define the problem in a human-centred way. The team members also discuss ideas to solve these problems.
- 1.4. **Ideate:** As a result of generating creative ideas, group members agreed to create a Programming Education Cards game that could solve the related problems. Considering its low cost, fast implementation, high impact and sustainability. SWOT analysis is used to complete the recommendations that have been made, the results of the team members by producing a prototype first.
- 1.5. **Prototype:** Group members have produced the first prototype and improved on the second prototype which is better and more appropriate. In addition, the group has produced a complete set of components to facilitate the testing process.

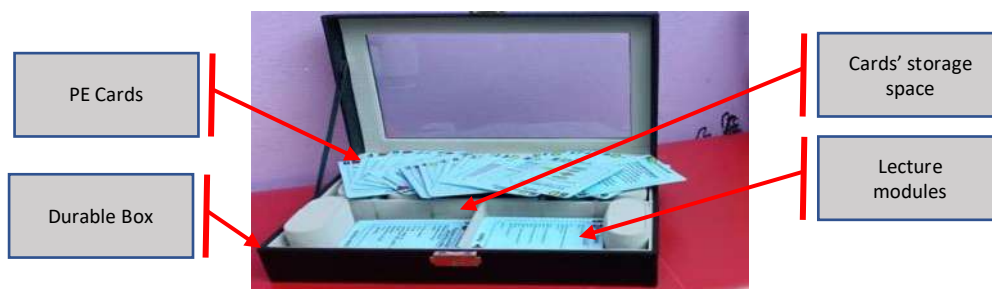

1.6. Learning Domains

- I. **Holistic learning:** PECgame aims to create a holistic learning experience by incorporating all the three domains in learning, cognitive, psychomotor and affective.
- II. **Psychomotor skills:** It is an innovative game that requires psychomotor skills for the players to arrange and sort the cards in their possession according to the learning module.
- III. **Exercise:** They exercise their hand-eye coordination and improve their fine motor skills.
- IV. **Cognitive skills:** Cognitive skills will require the players to understand and learn about the fundamentals of programming through reading, remembering and playing.
- V. **Intellectual skills:** When the students play this card game, they exercise their intellectual skills and cognitive strategies.
- VI. **Affective skills:** The affective skills involve feelings, attitudes and emotions. The discussions among the players get them to demonstrate appropriate emotional responses.
- VII. **Involves:** The affective skills involved in playing the games include values, enthusiasms, motivations, patience, evaluation, ethics, communication and teamwork.
- VIII. Invention in addressing the related problems:
 - a. **Observation:** From observation, many students are not interested in learning about programming. They tend to become sleepy while in class and are not focusing on the tasks given to them.
 - b. **Create:** Create a more positive and fun learning environment.
 - c. **Boost:** Boost their confidence in writing the accurate programming statements and programs.
 - d. **Platform:** Prepare a platform or medium where they can practise their programming skills freely without feeling inhibited.
- IX. How it contributes to new knowledge / technology:
 - a. **Prepare:** Prepare a platform or medium where they can practise expressing themselves in basic concepts, write program statements and program code.
 - b. **Learn:** Where they can learn some basic concepts, write program statements and program code.
 - c. **Create:** Create a platform where they can learn Programming Language in a simple way.
 - d. **Incorporate:** Create a platform where they can incorporate all the Programming skills.

PEGGame's Importance to Education

- i. Creativity and innovation: The idea for this project is based on creativity which is translated into an innovation that benefits the end users, namely the students.
- ii. High impact: Clients (students) – fulfils clients' expectations to improve their Programming language theory and practical.
- iii. Excellent value return: Saves time through user-friendly innovation. Eliminates mistakes through the structure of the Trainer. Saves cost because the project does not require the use of expensive-high end materials. It is very flexible and can be used by students in all levels of proficiency.

Advantages of your Innovation / Product Development / Design / Process towards Education and Community

- i. Consists of a complete package of control modules, inputs, outputs, programming tools, module notes and a trainer box with an interesting meet and match puzzle module concept.
- ii. Able to increase students' understanding of programming concepts more easily.
- iii. Students can use the tool without complete assistance from the lecturer as all the notes and manuals are already available.
- iv. The materials used are portable and durable.

Marketability or Profitability of your Innovation

- i. Suitable : Suitable for usage in all Malaysian polytechnics and institutions of higher learning.
- ii. Applied : Applied in kindergartens, primary schools as well as secondary schools.
- iii. Potential : Has potential to be commercialized for all educational institutions either locally or abroad as it is the first kind of innovation produced for the learning of Programming.
- iv. Innovation : The innovation project produced can compete in the domestic and foreign markets.
- v. Project : Innovation project that is safe to use, attractive, cheap and can easily be used everywhere.
- vi. Concept : This concept of innovation can be adapted to the various teaching materials needed

Significance and Positive Impact to Customers (Students)

- i. Improve : Improve efficiency and optimize the delivery of knowledge to students.
- ii. Utilizing : Utilizing gaming capabilities in education.
- iii. Facilitate : Facilitate the teaching and learning process.
- iv. Increase : Increase the self-confidence of students and lecturers.
- v. High : High and comprehensive positive impact on the field of national education.
- vi. Positive : Positive impact on students' Programming proficiency and game players.

Cards' Arrangement & Intellectual Property

Arrangement of gate symbols according to strength/size

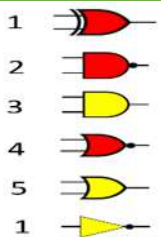

Arrange card numbers according to strength





Affidavit



MYIPO Copyright

References

- Neil C.C. Brown, Amjad Altadmri. (2014). Investigating Novice Programming Mistakes: Educator Beliefs Vs. Student Data. Proceedings Of the Tenth Annual Conference on International Computing Education Research, Glasgow, Scotland, United Kingdom.
- Norhayati Sa'adah and Nur Wahidah. (2018). Persepsi Pelajar dan Pensyarah Terhadap Kegagalan Pelajar dalam Kursus Pengaturcaraan.
- Tan.R.C, Rozita and Lim B.P. (2017). Masalah Pelajar dalam Mempelajari Pengaturcaraan Bahasa Penghimpun.

SMART NOTES

Nik Noorafieda Binti Wan Azraen

Politeknik Kota Bharu, Km24, Kok Lanas, 16450 Ketereh, Kelantan
noorafieda.poli@igovuc.gov.my

Highlights: SMART NOTES is one of the innovations for teaching and learning materials in the form of multimedia for the PROJECT MANAGEMENT course. It is to equipped students with basic knowledge and understanding of construction management in a simple form. The course also provides students with information and concepts of project planning and scheduling. The use of Microsoft Project for planning and scheduling are the features of advantages and disadvantages and also functions of various types using critical path methods. According to Eddy (2011), the selection of android apps is because android smartphone users outnumber iOS users. Sa'adiah (2020) also mention that the teaching and learning approach (PdP) implemented today, should be adapted to the development of technology and educational needs of the 21st century, in line with the seventh shift of the Malaysian Education Development Plan (2013-2025), which is to utilize ICT (Communication & Information Technology) to improving the quality of PdP in Malaysia [4]. These will expose students to computer applications or other database software.

Keywords: Smart Notes, Project Management, Comprehension, Mastering Learning, Brief Notes

Introduction

This innovation is triggered to provide facilities and as deeper understanding of Project Management and the learning implements as an Action Guide to meet the satisfaction of lecturers, students and institutions, especially in line with modern technology in a borderless world. Students can easily refer to short notes wherever they are just by using a mobile phone. The objective of producing teaching and learning (T&L) projects in the form of multimedia for this Project Management course is divided into three levels, namely lecturers, students and institutions. The impact and benefits of the material produced is where lecturers can learn and apply technology in teaching and learning. Lecturers are able to create a culture of research and innovation among them. The impact for students is that they can master their learning easily and effectively and create a fun learning environment wherever they are. The impact for the institution is to make the polytechnic grow in line with the passage of time and offer courses that are competitive in the era of globalization and meet the needs of the industry. The types of software used in producing this innovation are Microsoft Work, Microsoft Office Power Point 2010, Google Drive, App geysers and Google Play Console.

Problem Statement

- i. Providing innovation as well as a dynamic touch that will drive a quality, creative and innovative educational process to be produced.
- ii. To attract students to understand project management courses more effectively

Inventiveness/Novelty

Developing Smart Notes Applications. The method of implementing this innovation has been developed by asking students to download the Smart Notes application using the link provided. (https://files.appsgeyser.com/Smart%20Notes_12950672.apk) or download the Smart Notes app on the Play Store.

Figure 1: The figure below showed a few displays of the Smart Notes.



Referring to Graph 1.1, the percentage of final examination results for this course increased after the students were exposed to the use of Smart Notes application. If we look at the December 2019 session, 78% of students got grade A and in the June 2020 session, 93% of students got grade A. 22% of students got grade B in the December 2019 session and 7% for the June 2020 session.

Graph 1: The graph below showed a comparison of final exam results before and after using Smart Notes application

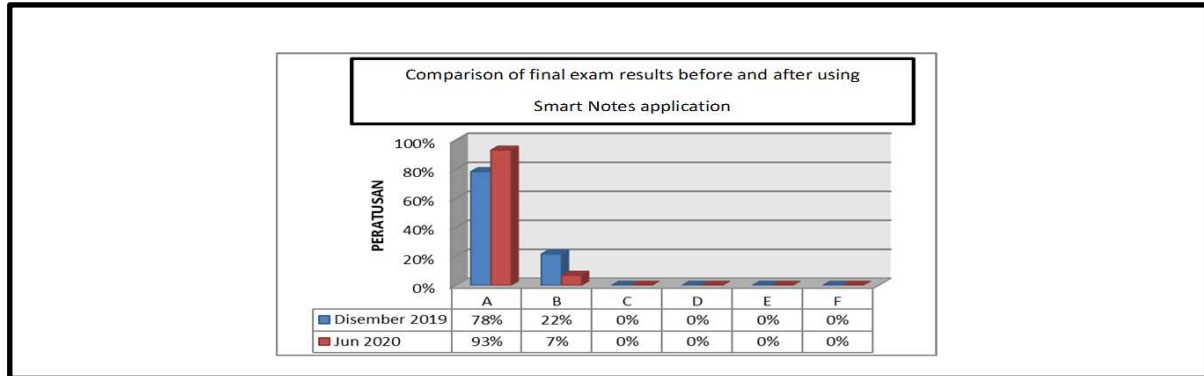

Advantages

Smart Notes is offline and does not require an internet network after downloading the application. Make it easy for students to review lessons no matter where they are. Smart Notes also save on paper usage, fun notes and add to students' interest in continuing to read.

Commercialisation

All lecturer of the June 2020 Session has used Smart Notes and applying technology in teaching and learning. To create a culture of research and innovation among lecturers. Students also able to master learning easily and effectively and creating a fun learning environment. For Institutions, developing polytechnics grow in line with the passage of time and offering courses that are competitive in the era of globalization and meet the needs of the industry.

Others

Join the 5th National Research of Intellectual Seminar Proceeding (POLYCCRISSE'21) and in MyIPO registration application process.

References

- Eddy, N. (2011, December 8). Cloud Computing: Cloud, Mobile Apps, Public Storage Are Top IT Trends for 2012 and Beyond: Gartner. Retrieved from: <http://www.eweek.com/c/a/Cloud-Computing/Cloud-Mobile-Apps-Public-Storage-Are-Top-IT-Trend-for-2012-and-Beyond-Gartner-130060/>
- Sa'adiyah Mohamad1, Norhazlinda Idris dan Azrini Idris (2020). Pembangunan Aplikasi Mobil Pengajaran dan Pembelajaran: Measurement Fun and Easy. Jabatan Kejuruteraan Elektrik, Politeknik Tuanku Syed Sirajuddin, Arau, Malaysia.

STACK THE ENGLISH GAMES (STEN.G) INNOVATION FOR TEACHING AND LEARNING

Melissa Khor Suan Chin

Politeknik Kota Bharu, Kelantan, Malaysia
melissa@pkb.edu.my

Chung Boon Chuan, Siti Martini Binti Mustapha

Politeknik Kota Bharu, Kelantan, Malaysia
bchuan@pkb.edu.my, martini@pkb.edu.my

Highlights: STEn.g stands for "Stack the English Games" that consist of 51 durable wooden blocks, which contain English language learning information. Within one complete package, there are 4 sets of English language learning materials. These 4 learning sets have covered the entire learning of English language modules at Polytechnics for level 1, 2 & 3 and can even be used by anyone who wants to play while learning to master English. The colour method on the wooden blocks is used to differentiate each learning module to be presented. STEn.g is arranged vertically, and the player must draw one piece of information at a time according to the fixed arrangement of numbers. After that, the player will arrange this piece on the knowledge display board reserved for each set of English language learning materials. English is the 2nd or 3rd language for Malaysians. Therefore, in some cases, the mastery of this language is at a low level, plus the learning of this language is very boring. STEn.g game is an innovation game that requires psychomotor skills for the players to carefully take one block of wood from a stack without dropping any of the block within the stack. If that happens, the player will go through the English educational and knowledge penalty. Whereas, cognitive skills will require the players to understand English learning correctly through reading, remembering and playing, while affective skills include patience, evaluation, ethics, communication and team work. This innovation can give students the pleasure to play the game indirectly whereby the usage of English can be applied. Players need to communicate using English while playing. Not only do players master the components of basic English, grammar, letter format, resume, vocabulary, but also basic presentation skills. This STEn.g simplifies the learning process, saves time and makes the whole learning and teaching process become fun and interesting.

Key words: *English language learning, Design Thinking, Cognitive Domain, Affective Domain, Psychomotor Domain.*

Introduction

English language is considered as a difficult subject to master by most of the students, especially in Malaysia. This is because English language is not our mother tongue. Therefore, they are not interested and have low motivation to learn English. They often feel shy and are not confident enough when trying to communicate using the English language. The lack of English vocabulary and knowledge in English grammar became huge obstacles for them to master the language. According to Khalijah, Masliza et al. (2019), in learning a second language, it is utmost important that learners receive maximum support in terms of supportive and conducive learning environment as well as adequate and meaningful language experience.

To solve the problems, STEn.g is being introduced to create a more fun and positive English learning environment. B. William & K.Selvi (2011) state that to learn a second language, a physical, intellectual and emotional involvement is needed to successfully send and interpret linguistic messages. This innovation in a form of game will get the students involve actively. It boosts the players' confidence and build their self-esteem when they are among peers, with lecturers and even outsiders. The vocabulary exercises and grammar exercises throughout the game will enhance their existing English language competency. A research conducted by Dr. A. Ibrahim (2017) revealed that teaching language games are useful to EFL Learners. Language games can help students in building a good relationship with the new language.

Innovation / Product Development / Design / Process

This STEn.g game innovation is inspired by a popular game "Jengga Uno Stack" which also uses wooden blocks. It is produced using the Design Thinking Model method, which involves 5 processes namely Empathize, Define, Ideate, Prototype and Test. This STEn.g innovation involves new inventions namely games and learning modules that innovate in packages.

This creative STEn.g consists of 4 sets of English language learning materials within one complete package. Set 1-General English, Set 2-Communicative English, Set 3-Speaking Tasks and Set 4-Writing Tasks. These 4 learning sets cover the entire learning of English language modules at polytechnics for level 1, 2 & 3 and can even be used by anyone who wants to play while learning to master English.

This innovation is unique as the colour method on the wooden blocks is used to differentiate each learning module to be presented. The colour method in STE.g makes the appearance more attractive and appealing to the players. The selection of the colours is also based on the philosophy of colours. The wonderful colours would trigger the players' emotions. Psychologically, colours can enhance learning. This is because colours can affect neurological pathways in the brain. Every colour has a specific wavelength, and each of these colour affects our body and brain in a different way. (Dr. Robert Gerard, 1958).

There are 51 durable wooden blocks, which contain English language learning information. Wood is chosen as the main material for the stacks because it is natural, safe to handle and touch, more durable and does not break easily. Besides, it is cost effective as it is cheaper compared to plastic or metal.

The learning process will involve three (3) learning domains namely cognitive domain, affective domain and psychomotor domain. These three domains are essential to be applied in teaching and learning. The cognitive domain aims to develop the mental skills and the acquisition of knowledge for the course. Affective domain includes the feelings, emotions and attitudes while playing game. As for the psychomotor domain, it includes utilizing motor skills and the ability to coordinate them.

This game can be applied to other courses as learning materials as well. This creative innovation makes learning more fun, challenging and exciting. At the same time, it can test the students' thinking skills and enhance their English language proficiency. The use of interesting and suitable materials along with the various approaches when conducting language games during lessons helps to cater to learners' needs and interests on the subject-matter especially in learning grammar in context (Nur Syafiqah & Melor, 2019).

Background of the Innovation / Product Development / Design / Process

- **Design Thinking:** This innovation incorporates the Design Thinking as problem solving approach and involving five phases—Empathize, Define, Ideate, Prototype and Test.
- **Empathy:** At this stage, the researchers try to be empathic in order to understand the English language learners at Politeknik Kota Bharu, their needs and problems that they face is human-centric. It focuses on the client's requirements and needs, which are essential in the innovation for delivery of services.
- **Defining the Problem:** At this stage, the researchers analyse the information that they have gathered and synthesise them so that they can identify and define the problem in a human-centred way. The team members also discuss ideas to solve these problems.
- **Ideate:** Numerous group discussions have resulted in ideas on how to solve the problems in English language learning. These ideas have brought about the creation of education games towards creating a more interesting, fun English language learning experience. Considering its low cost, fast implementation, high impact and sustainability. SWOT analysis is used to complete the recommendations that have been made, the results of the team members by producing a prototype first.
- **Prototype:** Group members have produced the first prototype and improved on the second prototype which is better and more appropriate. In addition, the group has produced a complete set of components to facilitate the testing process.

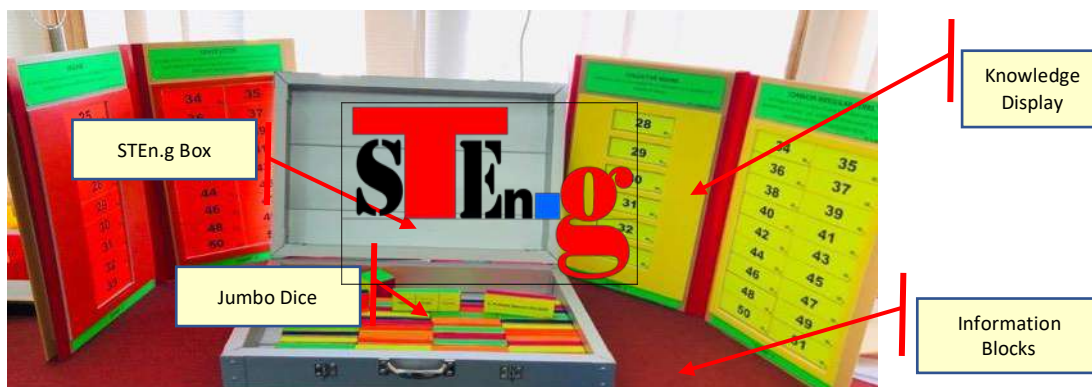

Learning Domains

- X. **Holistic learning:** STE.g aims to create a holistic learning experience by incorporating all the three domains in learning, cognitive, psychomotor and affective.
- XI. **Psychomotor skills:** It is an innovation game that requires psychomotor skills for the players to carefully take out one block of wood from a stack without dropping any of the block within the stack.
- XII. **Exercise:** They exercise their hand-eye coordination and improve their fine motor skills.
- XIII. **Cognitive skills:** Cognitive skills will require the players to understand English learning through reading, remembering and playing.
- XIV. **Intellectual skills:** When the students answer the questions, they exercise their intellectual skills and cognitive strategies.
- XV. **Affective skills:** The affective skills involve feelings, attitudes and emotions. The discussions among the players get them to demonstrate appropriate emotional responses.

- XVI. **Involves:** The affective skills involved in playing the games include values, enthusiasms, motivations, patience, evaluation, ethics, communication and teamwork.
- XVII. Invention in addressing the related problems:
- Observation:** From observation, many students are not interested to learn English. They tend to become sleepy while in class and are not focusing on the tasks given to them.
 - Create:** Create a more positive and fun English learning environment.
 - Boost:** Boost their confidence to use English language especially in oral communication.
 - Platform:** Prepare a platform or medium where they can practise English freely without feeling inhibited.
- XVIII. How it contributes to new knowledge / technology:
- Prepare:** Prepare a platform or medium where they can practise expressing themselves in English without feeling shy or embarrassed.
 - Learn:** Where they can learn some expressions in English that can enrich their word power.
 - Create:** Create a platform where they can learn English grammar in a simple way.
 - Incorporate:** Create a platform where they can incorporate all the four language skills, reading, writing, speaking and listening.

STEn.g's Importance to Education

- Simplifies: This innovation simplifies the learning process, saves time and makes the whole learning and teaching process become fun and interesting.
- Pleasure: Gives students the pleasure to play the game indirectly whereby the usage of English can be applied.
- Creativity: The idea for this project is based on creativity which is translated into an innovation that benefits the end users, namely the students.
- High impact: Clients (students) – Fulfils clients' expectations to improve their English language proficiency.
- Excellent value return: Saves time through user-friendly innovation. Saves cost because the project does not require the use of expensive-high end materials.
- Flexible: It is very flexible and can be used by students in all levels of proficiency.

Advantages of your Innovation / Product Development / Design / Process towards Education and Community

- Consists of a complete package for English language learning.
- Allow the students to master the general English.
- Covers the entire learning of English language modules at polytechnics for Communicative English 1, 2 & 3.
- Can be used by anyone who wants to play while learning to master English.
- Provide opportunity for students to interact actively during the speaking tasks.
- Students can communicate their ideas confidently.
- The writing tasks allow the students to improve their writing skills.
- Able to increase students' understanding.
- The materials used are natural, safe and durable.

Marketability or Profitability of your Innovation

- Suitable : Suitable for usage in all Malaysian polytechnics and institutions of higher learning.
- Applicable : Applicable in kindergartens, primary schools as well as secondary schools.
- Potential : Has potential to be commercialized for all educational institutions either locally or abroad as it is the first kind of innovation produced innovation produced in the field of English language education.
- Innovation : The innovation project produced can compete in the domestic and foreign markets.
- Perfect : Innovation project that is safe to use, attractive, cheap and can easily be used everywhere.
- Concept : This concept of innovation can be adapted to the various teaching materials needed.

How to play

- ARRANGE** - STEn.g is arranged vertically, and the player must draw one piece of information at a time according to the fixed arrangement of numbers.
- TAKE OUT** - The players will carefully take out one block of wood from the stack without dropping any of the block within the stack.
- KNOWLEDGE BOARD** - After that, the player will read that piece of information block while other players listen. Then the player will arrange this piece on the knowledge display board reserved for each set of English language learning materials.
- PENALTY** - If stack collapses, the player will go through the English educational and knowledge penalty.

Intellectual Property



References

- B. William Dharma Raja and K.Selvi. (2011). Causes Of Problems in Learning English as A Second Language as Perceived by Higher Secondary Students. *i-manager's Journal on English Language Teaching*, Vol. 1.
- Dr. Abdelrazig Ibrahim. (2017). Advantages of Using Language Games in Teaching English as a Foreign Language in Sudan Basic Schools. *American Scientific Research Journal for Engineering, Technology, and Sciences (ASRJETS)*.
- Khalijah binti Mohd Nor, Masliza binti Mohd Razali & et al. (2019). Students' Problems in Learning English as A Second Language among Mdam Students at UITM Malacca. *International Journal of Humanities, Philosophy, and Language*. Volume: 2, Issues: 7, pp.01-12.
- Nur Syafiqah Yaccob and Melor Md Yunus. (2019). Language Games in Teaching and Learning English Grammar: A Literature Review. *Arab World English Journal (AWEJ)* Volume 10. Number 1.
- The Psychology of Color: How Do Colors Influence Learning? <https://www.shiftelearning.com/blog/how-do-colors-influence-learning>

SEISMIC REFLECTION INTERPRETATION USING AR APPLICATION TO ENHANCE UNDERGRADUATE STUDENT'S UNDERSTANDING

Noorzamzarina binti Sulaiman

Geoscience Department, Faculty of Earth Science, Universiti Malaysia Kelantan Jeli Campus, 17600 Jeli Kelantan,
Malaysia
zamzarina@umk.edu.my

**Nursufiah bte Sulaiman¹, Rohazaini binti Muhammad Jamil¹, Wani Sofia binti Udin¹, Nor Shahida binti
Shafiee @ Ismail¹, Fazrul Razman bin Sulaiman²**

¹Geoscience Department, Faculty of Earth Science, Universiti Malaysia Kelantan Jeli Campus, 17600 Jeli Kelantan,
Malaysia

²Faculty of Applied Sciences, UiTM Cawangan Pahang, 26400 Bandar Tun Abdul Razak Jengka, Pahang, Malaysia
nursufiah@umk.edu.my, rohazaini@umk.edu.my, wanisofia@umk.edu.my, shahidashafiee@umk.edu.my,
fazrul@uitm.edu.my

Highlights: Augmented Reality (AR) in education features aspects that enhance learning of abilities like problem-solving, collaboration and creation to better student's preparation for the future. It is also good for traditional pedagogy focused on technical knowledge and proficiencies. AR's relative seamlessness of digital objects within the real world encourages interactivity and engagement. It maximizes student's ability to spend their time learning curricular subjects while minimizing the time spent learning how to use the new technology. In addition, virtual reality (VR) applications within the classroom and the effect of the body's actions on the mind, AR can also inspire empathy in an individual. It offers two-dimensional methods of presenting information versus the traditional one-dimension. Therefore, AR provides students with opportunities to deepen their knowledge within several areas including real-life environments and scenarios, spatial concepts and working with number.

Key words: *Augmented reality, Virtual reality, interactive, seismic facies, geological structure, education*

Introduction

Seismic facies are mappable, three dimensional seismic units composed of groups of reflections where parameters differ from those adjacent facies units. Seismic facies analysis is the interpretation of seismic reflection parameters, such as amplitude, configuration, continuity, and frequency within the stratigraphic framework of a depositional sequence. Geophysicists use seismic attribute as a method to analyze seismic facies. Seismic facies analysis has broad applications in subsurface interpretation and reservoir characterization from 3-D seismic surveys, which aims at delineating structural and depositional features by quantifying seismic signals using various algorithms (Haibin & Dengliang, 2017). Structure interpretation and fault/fracture characterization can be analyzed by extracting the seismic geometric attributes. A few attributes measure the lateral changes in certain properties of the signal in a reflection seismic section/ volume, including waveform/amplitude and two-way time/depth and they can be further categorized as coherence and its derivatives (Bahorich & Farmer, 1995; Marfurt et al., 1998). Seismic reflection pattern geometries are perhaps the most useful for calibration with lithofacies interpreted from well logs, cores and cuttings. The amplitude analysis of 3D seismic horizon slices is the best technique that directly yielding to the width of channel belts and channel pattern image (channel splitting, sinuosity) of subsurface sandstone bodies (Weber, 1993; Hardage et al., 1994; Hardage et al., 1996; Burnett, 1996). It can predict the spatial distribution of channel-belt thickness and lithofacies. However, this method depends on the resolution of the seismic data relative to the thickness of the sandstone body image. It is also need to calibrate to the cores and the wireline-logs [8]. The seismic facies are interpreted by using the horizon or sequence boundaries. In order to choose the most prominent seismic reflectors as sequence boundaries, all possible sequence boundaries were initially identified in a high quality seismic reflection section [9]. This study aims to highlight the types of seismic facies and geological structures in the study area using AR application.

Content

This study uses 3-D seismic dataset that covering approximately 187 km² located at the southwest Malay Basin (Figure 1). The bin spacing of inline and crossline for these surveys are 12.5 m and 12.5 m, respectively. The vertical length used in this study ranges from 0 ms to 6500 ms two-way time. The seismic data provided by the Petroleum Management Unit is secondary data covering basic maps and seismic templates. This data needs to be reworked for processing and interpretation by using the computer version of Kingdom version 2018.

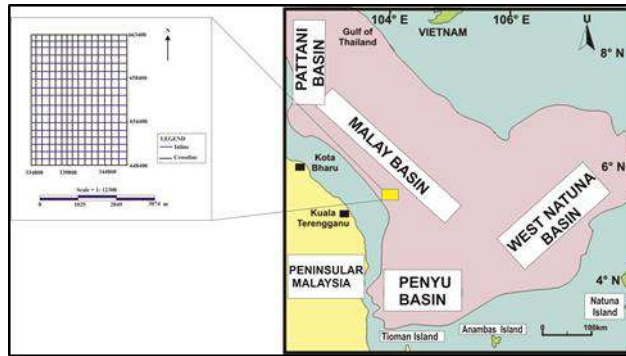

Figure 1: Study area located at the southwest of Malay Basin

The SEG-Y data format was imported into seismic computer software. The seismic reflection can be divided into three levels i.e.; data acquisition, data processing and data interpretation. Sequence boundaries were determined and interpreted to recognize and correlate a seismic sequence boundary accurately. Sequence boundary was determined by the occurrence of unconformity. The geological age of layers at the top and below of unconformity being determined for provided the size of hiatus at the certain area. The two-way time of sequence boundaries being detected by lateral that may become parallel but the hiatus being an evidence for continued to determine the unconformity. The seismic facies analysis was used to determine sedimentary sequence units generally through polar and patterns indicated in the seismic cross section. The interpretation of geological structure will only discuss the brief structure of the study area along the seismic survey lines.

Four sequence boundaries are recorded (0- 7 s two-way time (TWT)) from two seismic sections obtained in the southwestern part of Malays Basin. SB1 is in the Pleistocene age. Meanwhile SB 4 is interpreted as basement rock which is located in two-way time (TWT) ranges from 4.5 to 7.5 s and consists of potential hydrocarbon such natural gas. According to the facies analysis that had been done and geological structure that presence at the field, this field have a potential hydrocarbon. This can be look through the indicators of the hydrocarbon such as anticline and syncline structure. The seismic facies analysis show that the variety of seismic facies pattern associated with the polar pattern in this seismic survey. In addition, according the presence of chaotic reflectors it maybe also associated with gas at the field. Augmented Reality is capable of augmenting computer-generated graphics into the real environment on screen. It means if you move your mobile camera to space, AR enables you to see a computer-generated object on your screen. Altogether, it happens in real time while you view it from your camera. This technique can enable students to learn in a more interactive environment.

Acknowledgement

We would like to thanks Petroliaam Nasional Berhad (PETRONAS) for providing the 3-D seismic dataset. Special thanks to Universiti Malaysia Kelantan for giving us the fund (Short Term Grant Scheme, SGJP: R/SGJP/A0800/01725A/001/2019/00597) to complete this research.

References

- Bahorich, M. & Farmer S. (1995). 3-D seismic discontinuity for faults and stratigraphic features: The coherence cube: *The Leading Edge* 14: 1053–1058.
- Burnett, M. (1996). 3D Seismic expression of a shallow fluvial system in west central Texa. In: Weimer, P., & Davis, T.L. (Eds.), *Applications of 3-D seismic data to exploration and production. AAPG Studies in Geology 42 and SEG Geophysical Developments 5*: 45-56.
- Haibin Di & Dengliang Gao. (2017). Nonlinear gray-level co-occurrence matrix texture analysis for improved seismic facies interpretation. *Research Article*, 5 (3): SJ31-SJ40.
- Hardage, B.A., Levey, R.A., Pendleton, J., Simmons, & Edson, R. (1994). A 3-D seismic case history evaluating fluvially deposited thin-bedded reservoirs in a gas-producing property. *Geophysics* 59: 1650-1665.
- Hardage, B.A., Levey, R.A., Pendleton, J., Simmons, & Edson, R. (1996). 3-D Seismic imaging and interpretation of fluvially deposited thin-bed reservoirs. In: Meimer, P., & Davis, T.L., (Eds.), *applications of 3-D seismic data to exploration and production. AAPG/SEG*: 27-34.
- Marfurt, K. J., Kirilin, R. L., Farmer, S. L., Bahorich, M. S. (1998). 3-D seismic attributes using a semblance-based coherency algorithm: *Geophysics* 63: 1150–1165.
- Weber, K.J. (1993). The use of 3-D seismic in reservoir geological modelling. In: Flint, S.S., & Bryant, I.D., (Eds.), *The geological modelling of hydrocarbon reservoirs and outcrop analogues. International Association of Sedimentologists Special Publication 15*: 181-188.

TALKING SNAKES & LADDERS

Marianti binti Mohd Suhaimi

Politeknik Kota Bharu, Kelantan, Malaysia
madamyanz2185@gmail.com

Highlights: English language has become an international common tongue as it is used by people around the world for communication. However there are still many people in Malaysia who are not fluent and reluctant to speak in English including students at Politeknik Kota Bharu. Thus an innovation called 'Talking Snakes & Ladders' board game is created as a supplementary teaching material to encourage students to speak in English. 'Talking Snakes & Ladders' is inspired by the famous traditional Snakes and Ladders board game as it is an enjoyable game to be played by all levels of students. The use of this board game is aimed to attract students' interest in speaking English while having fun with friends.

Key words: snakes and ladders¹, board game², communication³

Introduction

'Talking Snakes & Ladders' board game is designed based on the idea of traditional Snakes & Ladders game but it has been improved to be used as a language game for the purpose of improving English speaking skill. Talking Snakes & Ladders board game is created to promote interaction and communication among the students as stated by Talak-Kiryk (2010), that 'games can inspire interactivity as students are processing and working with the materials as well as with classmates'. Thus the use of this language game is hoped to encourage students to speak in English and promote a better communication among classmates.

Content

1. Description of the innovation.

The concept of "Talking Snakes & ladders" board game is similar to the famous and old snakes and ladders but has been modified by adding question marks and mystery cards for speaking tasks. The process of making this board game started with creating the board game by using PicsArt and PhotoLayers to design and draw the board with 10x10 grids, snakes, ladders and the question marks that need to be used for the game. After drawing and designing process, the snakes and ladders were arranged according to the selected numbers on the board. The numbers without snakes or ladders were put question mark symbols to arouse students' interest in answering the mystery questions. Each of the question mark symbol comes with a piece of mystery card containing a speaking task. Players are required to complete all of the given tasks in order to reach at the end of the game. The game can be played by a group of 4 players at one time. Each of the player shall be given a token and they start to play the game by rolling the dice. The player with the highest score will go first. Players will have to take turn to move their tokens on the board according to the number on the dice that they roll. A number with a head of a snake will require the player to slide down his token to the bottom of the snake and a number with the base of a ladder will require the player to move his token to the top of the ladder. However a number with a question mark symbol will necessitate the player to talk according to the task stated on the mystery card such as 'talk about your pet'. Thus the player will have to talk in English in order to complete the task and reach the end of the game.

Figure 1: Layout of the board game and item descriptions

TALKING SNAKES&LADDERS		
ITEMS FOR THE BOARD GAME	NUMBER OF ITEMS	DESCRIPTIONS
DICE	1	Players have to roll the dice in order to start the game.
TOKEN	4	Each player is given one token, maximum number of token is 4.
COVER OF THE GAME	1	It contains the name of the game.
INSTRUCTIONS OF THE GAME	1	It is written at the back cover of the board game to explain on how to play the game.
MYSTERY CARD	30	A talking task is written on this mystery card that need to be completed by the player.
LAYOUT OF THE GAME	1	 Players have to start from this square.
	9	 Players have to move his/her token to the top of the ladder when they reach at the base of the ladder.
	30	 Number with question marks require the player to pick one mystery card and complete the given task.
	7	 A number with a head of a snake will require the player to slide down his token to the bottom of the snake.
	1	 The first player to reach at the top of the board will win the game.

2. The context or background of the innovation.

There are many students at Politeknik Kota Bharu who are still having problem to speak in English fluently due to low proficiency level and less of interest to speak in English with other people. This problem can be seen when students are struggling to speak English during oral presentation and group discussion as part of their assessments for Communicative English classes. Therefore, it is important for English educators to find an alternative way to gain students' interest in speaking. The use of language board game for speaking activity is believed to make the learning process becomes more enjoyable for the students.

3. Importance of the innovation to education.

This innovation is important to education because it can be used as a supplementary material for English educators to use it in class for English speaking activity. Furthermore, this innovation can be used as a tool to create a motivating and interesting English speaking activity for any level of students including low proficiency students who are afraid to speak in English as stated by Chang and Cogwell (2008) that the use of a board game in language classroom can be effective, low anxiety and enjoyable for students.

4. Advantages of the innovation to education.

There are several advantages of this innovation to education. Firstly, it can encourage students to speak English with their friends in class as they are required to complete the speaking tasks when they play the game. Secondly, it can motivate low self-esteem students to speak English in a stress-free situation when they are playing fun language games with friends. Thirdly, English educators do not need to force students to speak English in class because students will practice speaking while they are playing games.

5. Advantages of the innovation to community.

There are also a few advantages of this innovation to community. First of all, it can create a fun family bonding time for family members who play this game together. Besides that, students or children can spend their leisure time playing this language board game together with siblings or friends without using any gadgets that can affect their eyesight. Furthermore, it can also improve English proficiency among the community when they practice speaking English when playing this game.

6. Commercial value in terms of marketability or profitability of the innovation.

This innovation is useful for English educators and students at polytechnics as well as secondary schools to use it for speaking activity because it is enjoyable, handy and easy to bring anywhere. Furthermore, the cost for this language board game is only rm15. Thus it is affordable for everyone to buy it. This language board game is also suitable to be played by students and children at home to spend their leisure time with family while practice speaking. As for now, a few students from Politeknik Kota Bharu have tried to use this board game and interested to buy this board game because the price is reasonable and it is fun to play with friends.

References

- Chang, Sherley and Jenny Cogwell. (2008). Using Board Game in the Language Classroom. TESOL 2008.
Talak-Kiryk, Amy (2010). Using Games in A Foreign Language Classroom. MA Tesol Collection Paper 484.
<https://gurugamer.com/viral/snakes-and-ladders-rules-how-to-play-snakes-and-ladders-9957>.

MOBILE APPLICATION DEVELOPMENT TO TEACH ENGLISH PROFICIENCY COURSES

Nazatul Syima Mohd Nasir

Universiti Malaysia Kelantan, Bachok, Malaysia
syima.mn@umk.edu.my

Nor Hazwani Munirah Lateh, Khairul Hisyam Baharuddin, Amaal Fadhlini Mohamed

Universiti Malaysia Kelantan, Bachok, Malaysia
hazwani.l@umk.edu.my, khairulhisyam@umk.edu.my, fadhlini@umk.edu.my

Highlights: The app development industry has benefited from people's willingness to accept online instruction. Whether it's online learning, e-books, or other digital learning platforms, most educators and institutions are looking for learning applications. As a result, it is critical that a teacher provides the latest technology as innovative techniques of teaching English to EFL/ESL students when teaching English language classes. The appypie.com platform is one of the best for designing educational applications.

Key words: *mobile application, English proficiency courses, education*

Introduction

Rapid technological improvements have resulted in diversified and advanced material in specialised sectors as a result of innovative mobile applications relevant to education. According to Sung, Chang, and Liu (2016), mobile phones, personal digital assistants, and laptops are made learning possible both in and out of the classroom.

Appy Pie is one of the primary platforms that educators can utilise to create Android and iOS-based learning environments at Malaysian institutions to teach undergraduate English courses. Malaysian university students can use already created mobile applications to improve their English ability in pronunciation, writing, reading, and listening when learning English as a second language.

Content

Appy Pie is a company that develops no-code mobile application development software. The platform enables developers to construct iOS and Android mobile apps for free and in a short amount of time. The platform is open to everybody, giving educators the ability to design their own teaching app regardless of their technical skills, funding constraints, or coding knowledge. The developer can drag and drop features into the app using the platform.

Smartphone usage is on the rise, with 93.5 percent of smartphone users in Malaysia being under the age of 20. (Hwa & Peck, 2020). Smartphones, according to Zou & Li (2015), can be used in education due of their accessibility and features. In Malaysian colleges, an android-based mobile pronunciation application could be developed to teach English as a foreign language. The usage of mobile applications boosts learner motivation (Kocakoyun & Bicen, 2017).

Learners benefit from the platform since it provides them with applications that assist them gain information and learn about their hobbies as well as subjects studied in schools and colleges. When it comes to technology advancements, the platform allows the education sector to keep up with other disciplines.

Both the institutions and the community benefit from the development of a mobile learning application. Teachers and parents would benefit from the applications while arranging interactive learning. As a result, learning is not confined to classrooms using education applications, and they may be utilised productively during free time (Snigdha, 2020).

Because it is a no-code application platform, products are supplied on a freemium basis, allowing it to generate revenue through subscriptions while still giving a free version to users. This enables educators to use the platform outside of the classroom, in situations where less face-to-face engagement is required. The designed application can be commercialised in the long run to meet the needs of specific education market sectors

References

- Hwa, S. P., & Peck, W. K. (2020). Exploring the Smartphone Usage among Malaysian Youth: A Theoretical Framework. *International Journal of Advanced Research in Education and Society*, 2(2), 142-155.
- Kocakoyun, Ş., & Bicen, H. (2017). Development and evaluation of educational Android application. *Cypriot Journal of Educational Sciences*, 12(2), 58-68. doi:10.18844/cjes.v12i2.1938
- Snigdha. (2020, July 24). Benefits & must-have features of a great education app • Appy pie. Retrieved from <https://www.appypie.com/benefits-and-must-have-features-of-a-great-education-app>
- Sung, Y. T., Chang, K. E., & Liu, T. C. (2016). The effects of integrating mobile devices with teaching and learning on students' learning performance: A meta-analysis and research synthesis. *Computers & Education*, 94, 252-275.
- Zou, B., & Li, J. (2015). Exploring mobile apps for English language teaching and learning. *Critical CALL – Proceedings of the 2015 EUROCALL Conference, Padova, Italy*. doi:10.14705/rpnet.2015.000394

IoT RESCUE BUTTON

Nazratulhuda Hashim

Politeknik Sultan Salahuddin Abdul Aziz Shah, Selangor, Malaysia
nazratulhuda@gmail.com

Wan Majdah Ton Mamat, Zetty Rohaiza Mohd Ishak @ Sahak

Politeknik Sultan Salahuddin Abdul Aziz Shah, Selangor, Malaysia
maidah@psa.edu.my, zettyrohaizamohdsahak@gmail.com

Highlights: The world is hit by pandemic covid 19, which many parties may be affected by this condition. All sectors experience degradation and harm with this situation. The Education sector also had a significant impact not only on the economic, social, and security sectors but also constraints in the implementation of teaching and learning. Face-to-face methods are no longer the leading choice, but different alternatives need to be considered and implemented to ensure that the education system is not left behind. However, not all teaching and learning implementation can be done online. For assessments involving psychomotor methods, physical presence must be made in any way. With limited circumstances, security measures and surveillance should be maximized so that this process can run by the established procedures. Thus, a project has been considered to reduce face-to-face methods between students and lecturers when practical tasks are required by adopting the Internet of Things as daily practices. The IoT Rescue button was created to make it easier for students to call supervisors only when needed. As we know, the use of security tools such as gloves, goggles, and other safety equipment can slow down individuals to call supervisors during emergencies. However, the IoT concept project can overcome this disadvantage as the function of this tool is very simple and easy to access by the individuals involved. The project focused mainly on the access of supervisors when needed. The project focuses on an emergency button that is based on a press switch and uses the concept of Arduino, which sends signals to the phone. Therefore, even where the supervisor is on the alert and the message arrives, the supervisor can take the following action. The study has shown that with the IoT button, it is found that individuals can carry out tasks more confidently and safely as this method can get help and rescue quickly by simply pressing the switch.

Keywords: *Arduino, education, psychomotor, rescue, safety button, workshops.*

Introduction

Lately, the Internet of Things (IoT) is increasingly being used in everyday life. Most of the equipment in the market has combined the speed of the Internet with an intelligent system. IoT is defined as communication between one tool and another by using the Internet. IoT application progress makes it easier for many jobs, including remote and timely monitoring of individuals. For example, a smartphone can monitor and control the system when the smartphone is made an android-based application that connects to the internet network (Bhatt, 2017).

The Internet of Things (IoT) is a concept that applies to the use of connected, intelligent machines and systems to utilize data collected by sensors and actuators in machines and other physical objects. IoT works by utilizing a programming argument with each command of its arguments that results in an interaction between fellow machines that connected automatically without human intervention at any distance (Yodi Setiawan, 2018).

The main elements of the IoT architecture are:

1. Physical goods equipped with IoT module.
2. Connection to the Internet such as modem and router.
3. Cloud Data Centre where to store apps and databases.

Content

1. Product development.

The project focuses on an emergency button that is based on a press switch and uses the concept of Arduino, which sends signals to the phone. Figure 1 below showed the components that have been used in this IoT Rescue Button Project.

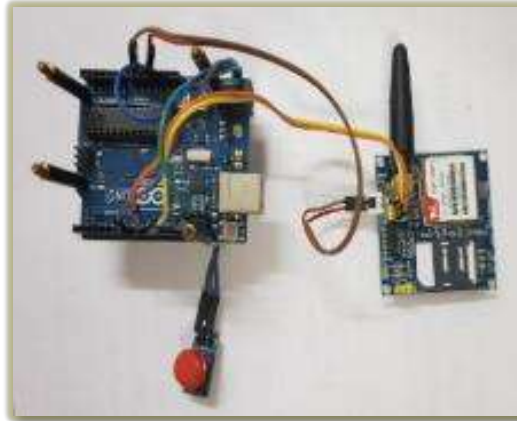

Figure 1: Internal components of IoT Rescue Button.

The list of components can be listed as below:

- Arduino SIM900A GSM GPRS wireless extension Module
- Arduino IIC, 12C TWI SPI Serial Interface 1602 LCD Module
- Big cap push button on/off sensor switch module
- Arduino CCTV Alarm/LED strip/12V 3A AC to DC Power Supply
- Arduino compatible Atmel DIP ATMEGA328
- Software sim900Amini.

2. Background of the innovation.

Engineering students, especially deaf and hard of hearing students (OKU) who carry out practical assignments, have difficulty calling lecturers due to personal safety equipment such as goggles and gloves that can slow down the process of calling lecturers, especially during emergencies. In this regard, this project was developed to overcome the problem besides reducing face-to-face methods between students and lecturers and reducing movement during the workshop.

3. Why are they essential to education?

Thus, a project has been considered to reduce face-to-face methods between students and lecturers when practical tasks are required by adopting the Internet of Things as daily practices. The IoT Rescue button was created to make it easier for students to call supervisors only when needed. As we know, the use of security tools such as gloves, goggles, and other safety equipment can slow down individuals to call supervisors during emergencies. However, the IoT concept project can overcome this disadvantage as the function of this tool is very simple and easy to access by the individuals involved.

4. They are two main factors of the advantages of this innovation:

1. Education purpose:

- i. To establish quick communication in the process of monitoring and sensitivity of students towards the use of equipment.
- ii. Students can call lecturers during assignments without having to remove the safety equipment.
- iii. Reduce face-to-face time between students and lecturers where lecturers are present only when called.

2. Social purpose:

- i. Household supervision.
- ii. Increase efficiency and effectiveness for monitoring and immediate action

5. Commercial value:

Target user:

1. Institution: Normal and Disable students
2. Community: Everyone, including Bedridden/sick people
3. Industry: Staff Employee and management

IoT Rescue Button application:

1. Emergency button
2. Call Button
3. Alert button

Acknowledgment

We are grateful to the Politeknik Sultan Salahuddin Abdul Aziz Shah for allowing this project to be tested in most workshops at Jabatan Kejuruteraan Mekanikal.

References

- Bhatt, J. B. (2017). IoT Techniques to Nurture Education Industry: Scope & Opportunities. *International Journal on Emerging Technologies*, 128-132.
- Yodi Setiawan, H. T. (2018). Penggunaan Internet of Things (IoT) untuk Pemantauan dan Pengendalian Sistem. *T E S L A*, 175-182.

LEGO MODEL LAYOUT PLAN TOOL KIT EXPLORATION FOR STUDIO-BASED LEARNING

J. Azri

Universiti Malaysia Kelantan, Bachok, Kelantan, Malaysia
Azri.min@umk.edu.my

N. A. H. Hamizah, H. Ramly, L. H. I. Ismi, M. K. Rizal, M. M Fadzli

Universiti Malaysia Kelantan, Bachok, Kelantan, Malaysia
Norhamizah@umk.edu.my, Ramly.h@umk.edu.my, Hamadi.i@umk.edu.my, Rizal.k@umk.edu.my,
Fadzli.m@umk.edu.my

Highlights: The online learning will cause the design-based education courses such as Interior Architecture, having hard time for its first-year students to really understand the design disciplinary by studying just through the 2D visualize layout without having proper physical 3Ds study materials to fully experiencing the space. Therefore, through this teaching innovation 'Lego Model Layout Plan Tool Kit' it was find out that it can enhance towards the students fun playful learning experience, interpretation of scale and space. It's allowed the students fast recognition regarding proper scaling and provided more degrees of freedom to design the space.

Key words: *Lego Model, Layout Plan Tool Kit, Playful Learning, Interior Architecture*

Introduction

Design based education is well known for its face-to-face physical teaching activities. It allows the students to physical interact with the space to explore and experience its contents. However, due to pandemic response and the changes of teaching method to online learning, it causes problems for the first-year students to perceive. Students seems to have hard time to understand regarding scaling and space. Therefore, this paper would like to propose an alternative way of teaching innovation which can enhance the student's learning experience, exploration, and proportion.

The 'Lego Model Layout Plan Tool Kit' which come in packed small modular block pieces regard to the template items, and scale selection act as Lego allow freedom to the students to play and explore the design with proper guidance towards scale and proportion. Students physically can have fun planning their idea first using the Lego block before finalizing the design on drawings.

This playful learning physical Lego created in eco-friendly plastic materials offers features to extend the online students learning scenarios. Using interlock system, colour coding block, and proper scale printed pattern, it will require student's logical reasoning capability to overcome the obstacle (the Lego) in order to complete the design. For instant, "finding a suitable information scale" will require students to know the background of situation and reasoning it with the hints in order to solve the design (Atmatzidou, et al., 2008; Legény & Teixeira 2019).

Every 'Lego Model Layout Plan Tool Kit' sets come with guidelines on how to design or play with them which can be seen as boxes packed with interesting/useful pieces.

By looking at the playing games at metaphorical or system levels, playful learning environment shows some important insights for the development of students design supporting system (Hill, et al., 2003; Whitton, 2018; Melero, et al., 2013).

Problem Statement

The idea came out due to data response done towards the first-year students in Interior Architecture Department in the Faculty of Architecture and Ekistics, Universiti Malaysia Kelantan that based on their opinions towards their online learning experience where majority of them had difficulty to understand the design scale in studio projects. Most of them cannot visualize the dimension in space correctly.

The physical teaching method is important as an early education in the development of student's basic understanding. In this study, it is believed that first-year students face problems in capturing the lessons because it require a more effective delivery medium or tool to ensure effective result, especially in mastering basic scale and proportion related learning.

Novelty And Inventiveness

Practically it coincides with enhancing the online learning process through physical Lego-solving design process with the aim of playful learning, by using the 'playing' characteristics to amplify and explore the learning process, furthermore the design process (Rice, 2009). Benefits derived from this type of activities are related to developing exploration skills and cooperation.

The physical teaching method is important as an early education in the development of student's basic understanding. By implementing the Lego playful learning environment, it can engage students in the subject topics, while at the same time foster students' problem solving, analytical and memory skills.

Creating a more physical playful immersive learning experience for students by bridging the physical and digital resources.

Product Description

Applying physical playful learning experience 'Lego Model Layout Plan Tool Kit' in the delivery of basic understanding on scale and design as a way to teach early design-based students. This teaching innovation highlighted the requirement of incorporating mechanisms that promote problem solving and students' motivation.

Commercialization

As bridging physical and digital learning resources this physical playful learning 'Lego Model Layout Plan Tool Kit' features to extend the online students learning scenarios which involved fun physical interaction activities. Furthermore, playful learning experience also can increase student knowledge understanding performance.

Advantages

Students can have fun in exploring space planning design with proper scaling by playing the 'Lego Model Layout Plan Tool Kit' contents with easy guidance which enhance their learning environment experience.

The interactive Lego block kit design creates a sense of fun and easy to use that can give students motivation to explore as well as to create the best outcome design.

The physical interaction learning process assist the early students who have difficulties in the visualization process through hand-on que model.

Publication

Seem that this teaching innovation 'Lego Model Layout Plan Tool Kit' is quite new, there were none publishing done yet. However, they will soon in the future.

Funded

Same as above, new application of funded grant will soon be applied for further promoting the innovation.

Intellectual Property

Currently the innovation has not yet been registered. However, application for copy right has been applied.

Acknowledgement

The authors are thankful to Universiti Malaysia Kelantan and its Interior Architecture Department to contribute and participate in this study.

References

- Hill, J. M., Ray, C. K., Blair, J. R., & Carver Jr, C. A. (2003). Puzzles And Games: Addressing Different Learning Styles In Teaching Operating Systems Concepts. In Proceedings Of The 34th SIGCSE Technical Symposium On Computer Science Education (Pp. 182-186).
- Atmatzidou, S., Markelis, I., & Demetriadis, S. (2008). The Use Of LEGO Mindstorms In Elementary And Secondary Education: Game As A Way Of Triggering Learning. In International Conference Of Simulation, Modeling And Programming For Autonomous Robots (SIMPAN). Venice, Italy (Pp. 22-30).
- Rice, L. (2009). Playful Learning. *Journal For Education In The Built Environment*, 4(2), 94-108.
- Melero, J., Santos, P., Hernández-Leo, D., & Blat, J. (2013). Puzzle-Based Games As A Metaphor For Designing In Situ Learning Activities.
- Whitton, N. (2018). Playful Learning: Tools, Techniques, And Tactics. *Research In Learning Technology*, 26.
- Legény, J. & Teixeira, A. G. (2019). Lego® Set As A Tool: Enhancing Creativity In Architecture, Urban Planning And Design

APPENDIX

Table 1 : Summary Of (25) Respondents Students Interior Architecture Department In The Faculty Of Architecture And Ekistics, Universiti Malaysia Kelantan (UMK) Perception Regarding The Useful Of Lego Models Layout Plan Tool Kit In Their Learning.

Please Indicate Your Response By Indicating The Most Appropriate Number.				
(1. Very Not Agreed/ 2. Not Agreed/ 3. Agreed/ 4. Very Agreed)				
Existing online studying- without the aid of Lego models layout plan tool kit				
Values	1	2	3	4
I had hard time to explore my design process	-	-	17 (68%)	8 (32%)
I had difficulty to understand my design scale	-	-	18 (72%)	7 (28%)
I'm feeling stress within the learning process	-	-	20 (80%)	5 (20%)
Existing online studying- after with the aid of Lego models layout plan tool kit				
Values	1	2	3	4
I had hard time to explore my design process	4 (16%)	21 (84%)	-	-
I had difficulty to understand my design scale	7 (28%)	18 (72%)	-	-
I'm feeling stress within the learning process	11 (44%)	14 (56%)	-	-

Account4U

Noorul Azwin Md Nasir

Universiti Malaysia Kelantan, Kota Bharu, Malaysia
Azwin@Umk.Edu.My

Siti Afiqah Zainuddin, Nadzirah Mohd Said, Noorshella Che Nawi, Tahirah Abdullah, Wan Farha Wan Zulkifli

Universiti Malaysia Kelantan, Kota Bharu, Malaysia
sitifiafiqah@umk.edu.my, nadzirah.ms@umk.edu.my, norshella@umk.edu.my, tahirah@umk.edu.my,
farha@umk.edu.my

Highlights: We want to develop a mobile application that ease the assessment process of an accounting course assignment. Through this apps the accounting students will be assessed by their lecturer based on their ability to assist and create awareness to informal business owners about the simplicity of recording business financial transactions. This apps works by connecting lecturer, students, and informal business owner. Students will be able to access the financial statement interface that they will work out with informal business owner. The lecturer will be able to see the assignment progress performed by his/her students. As for now, the name of the mobile app is **Account4U**.

Key words: *accounting, assessment tool, financial statements, informal business*

Introduction

Malaysia Education Blueprint: Higher Education 2015-2025, highlighted that higher educational students should be exposed with experience learning from the community which is stressed through Community Based Learning (CBL). For accounting course, this is a common practice and relevant. The assignment commonly designate by the lecturer for its students is a requirement to create a full set of account to real business operations.

Over the semesters, we have noticed that one prevalent concern among informal business owners is a reluctance to retain financial transaction records. Although accounting may be too hard for some, ignoring the necessity of financial recording as a business owner can be seen as irresponsible, especially if you have the knowledge. As a result, we want to propose an app that allows students to teach informal business owners the basics of recording financial transactions while also raising awareness about how simple it is to keep financial records for a business. At the same time, the lecturer can the students' progress while they are out on the field.

The term "informal business" refers to a company that is not registered with the Malaysian Companies Commission. In this proposal, the term "informal business owner" refers to small-scale firms that rely on the owner's skills. In many circumstances, if a firm can produce revenue from what they are selling today, they will presume that is their income, and the money will be utilised to buy ingredients for the things that will be sold the next day. Because it is a small firm that relies on cash for survival, practically all transactions are conducted in cash. However, it is difficult for the informal business owner to produce an answer when asked what the profit per product or daily is.

Accounting students, who are now learning financial transaction recording in accounting course, can assist informal business owners by demonstrating how simple the process can be and sharing the benefits that the process can provide. Under the direction of the teachers, accounting students deliver and share their theoretical knowledge and apply it to assist informal business owners in keeping basic financial records with **Account4U** app.

Content

Description of your innovation / product development / design / process.

Account4U is the name of a proposed mobile application. Accounting lecturer and students can use it as an assignment tool. Accounting students will be evaluated by their lecturer based on their ability to help and educate informal business owners about the ease of recording financial transactions using this app.

What is the context or background of the innovation / product development / design / process?

The **Account4U** app connects lecturer, students, and small business owners. The lecturer must first register in order to utilize the apps. The lecturer must next make at least one class in the app. Students will sign up for the class after receiving the class code. Students will have access to the cashbook interface, which they will develop with the monetary information shared by informal business owner. The lecturer will be able to monitor the progress of students' assignments.

Why are they important to education?

According to the Malaysia Education Blueprint: Higher Education 2015-2025, one of the nine (9) HIEPs pillars, Service/Community Based Learning (SBL), has been declared mandatory. SBL is supported by the **Account4U** app concept. Students will be able to learn by doing by assisting others and contributing their accounting expertise to the community through this app. By referring to the **Account4U** app, lecturer who own the applications will be able to assess students while they are on the field.

Please write any advantages of your innovation / product development / design / process towards education and community.

Account4U will let lecturer assess their students sharing accounting knowledge about keeping financial transaction records for informal businesses. This sharing will raise awareness among informal business owners on how keeping accurate financial records can help them make better business decisions, especially when it comes to sustaining their operations. This is a long-life learning opportunity for students. This app will allow lecturer to keep track of their students' progress during field assignments.

Please add any commercial value in terms of marketability or profitability of your innovation / product development / design / process if any.

Account4U application can be utilised by educational providers who offer accounting programmes once it is commercialised. The existence of the application and its user-friendly features will be appreciated by many, particularly in supporting lecturers in conducting assessments of students when they are on a field project. It is a win-win product that benefits lecturers, students, and informal business owners. Accounting education is extensive in Malaysia, and the profession remains in great demand. In Malaysia, the number of informal businesses is not insignificant, and they contribute to the economy as well. As a result, it is critical to meet the needs of informal business owners by providing higher education students with the opportunity to learn by doing through the *Account4U* app's capabilities.

Acknowledgement

We thanked the Centre of Academic Excellence and Development, Universiti Malaysia Kelantan for organizing the event and Faculty of Business and Entrepreneurship for encouraging staff's participations in an innovation event.

References

- Adhalina, N. (2011). The Different Language Style and Language Function Between Students and Teachers in Updating Their Status In Facebook Webpage (A Case Study of the Topic National Final Examination 2011)(Doctoral dissertation, University of Diponegoro).
- Van Dyke, J. (1994). People Smarts: Bending the Golden Rule to Give Others what They Want. Pfeiffer.

**THE LEMBAH SIREH-KB CITY WEB APP:
PROTOTYPE FOR SITE ANALYSIS IN FINAL YEAR ARCHITECTURE STUDIO TEACHING**

Najah Md Alwi

Universiti Malaysia Kelantan, Bachok, Malaysia
najah.ma@umk.edu.my

Mhd Hafiz Karami Mhd Zain, Muhammad Mujibur Rahman Bin Ahmad Safuan, Liew Ho Yen, Ariff Asyraf Bin Ab Rahman, Muhammad Azeem Bin Mohd Rizal, Nurul Fatimah Binti Said, Nur 'Izzatul Zaharah Binti Mohd Rosli

Universiti Malaysia Kelantan, Bachok, Malaysia
hafiz.k@umk.edu.my, mujibur.q18b0016@siswa.umk.edu.my, lhen.q18a0012@siswa.umk.edu.my,
ariff.q18b0049@siswa.umk.edu.my, azeem.q17a0040@siswa.umk.edu.my, fatimah.q18a0042@siswa.umk.edu.my,
izzatul.q17a0054@siswa.umk.edu.my

Highlights: What you will find in this exercise is detailed research data on Kota Bharu historical places, land use, transport hub, demographics and climate at your fingertips via a smartphone application. This project hopes to pave new ways into integrating technology and web application use into the traditional studio-based learning for architectural design.

Keywords: *Urban Analysis, City Web App, Mapping, Citizen Science*

Introduction

The wide use of mobile and web applications, along with the increasing popularity of citizen science in aiding scientific discoveries of cities and joining collaboration for placemaking initiatives is just the beginning of the fourth industrial revolution. To remain relevant, a revised version of a traditional architectural design process explores onto a different platform for sharing knowledge and meaningful data with local authorities and the public. This project will serve as a prototype to test the concept and semantics of this teaching innovation for studio-based learning.

Content

This project aims to contribute to a deeper understanding of the specified site (Lembah Sireh) before the next stage of the building design proposal. Knowing the limits of its geographic surroundings near the Kelantan River and its socio-economic relationship with Kota Bharu City is key to the course learning outcome. This exercise also plays a role in providing soft and hard skills for the students to adapt to the real world.

Innovation context

While every project in an architectural studio usually starts with a site visit to measure, observe and analyse a proposed site for a given task, much of these site studies also include a small radius of contextual research about its surrounding nature, people and its existing structures. Before the students arrive onsite, they are usually already in groups divided under specific themes of site investigations that aim to collect vast information in two levels of complexity: the macro and micro context. The macro study focuses on the role of the proposed site and how the location fits into the city. This study generally includes a trip to several local planning district authorities to inquire about maps and developmental plans for future city growth. The micro-study is where the students make a comprehensive study about the urban form overall, its history, human activity, demographics, and movement pattern in the agreed radius of the site. For the final year students, their range of urban data covers approximately 5km within the radius of the proposed site. In the case of the current students, their proposed site is Lembah Sireh.

Importance and significance

In the final product, the analysed information on how the city works, its opportunities and weaknesses are presented on a web application (also designed to be accessible on a mobile phone app) to guide and inform its targeted users. Not only does the data provide valuable architectural information about the city's historical and newest upcoming developments, but it also provides mapping for these cultural and gastronomic sites for which the city is known.

Marketability or profitability

This prototype web application has a high potential for both monetary and collaborative profit when paired and supported together either with relevant local authorities or local businesses. We aim for the innovation to continue for other studio projects as well to encourage more participation between different parties of stakeholders.

References

- Gehl, J. & Savarri B. (2013). *How to Study Public Life*. Washington: Island Press Cullen, Gordon. 1961.
Gehl, J. (2010). *Cities for People*. Washington: Island Press
Holl, Steven. *Questions of Perception: Phenomenology of Architecture*, eds Steven Holl, Juhani Pallasmaa, Alberto Perez- Gomez, A+I

Jen-HyPe: ENHANCING LEARNERS' ENGAGEMENT VIA HYBRID TEACHING AND LEARNING PEDAGOGY

Mohamad Najmi Masri

Faculty of Bioengineering and Technology, Universiti Malaysia Kelantan, Jeli Campus, 17600 Jeli, Kelantan, Malaysia
najmi.m@umk.edu.my

Mardawani Mohamad, Ain Zulaikha Zuhairi, Teo Pao Ter

Faculty of Bioengineering and Technology, Universiti Malaysia Kelantan, Jeli Campus, 17600 Jeli, Kelantan, Malaysia
mardawani@umk.edu.my, zulaikha.j19a0035@siswa.umk.edu.my, teopaoter@umk.edu.my

Highlights: Corrosion is core technology courses in Material Technology that comprises theory and practices regarding principle and application in industry. Conventional assessment for case study normally being conducted through face to face (F2F) consultation. In this invention, interview assessment being introduced for hybrid teaching and enhancing student's engagement through interactive activities for this case studies. This interview assessment was designed according to task-based in problem solving case studies for corrosion course. This assessment was designed to aligned with the course objectives of practical part related to technical aspects and application of corrosion process. From CLO analysis (student achievement index) and course grade analysis (grade scored), it was found that student performances are improved as compared to previous batch.

Key words: *Alternative assessment, Pedagogy, Interview assessment; interactive activities*

Introduction

In this innovation, interview assessment being introduced in corrosion course to enhance the understanding regarding the principles and technical aspect of this course. This course are technical core subjects for Bachelor of Applied Science (Material Technology) that being offered in fourth and fifth semester. In assessing student performance on a certain task, performance-based assessment criteria should be formulated on task-level as for each task a different set of criteria is relevant. Performance-based criteria are thus task-dependent. For novice students it is important to know the relevant criteria in every task. Fastré et al. (2002). It is likely that when students know exactly what to do, their motivation, learning and performance will increase significantly and they become more active to participate in class (see for example Ecclestone 2001). Moreover, Miller (2003) argues that having task-specific assessment criteria leads to a better quantitative differentiation of performance levels. This more detailed view on students' performance, would argue for the use of performance-based assessment criteria. It can be concluded that the use of performance-based criteria is especially beneficial for novice students because of their task-specific character. In this context, this invention being developed by introducing the application of real case studies for problem solving skills. This project being designed using performance-based assessment to implement hybrid teaching and learning that can prepare student for job skills and career's development in future.

Content

In a performance-based assessment, students are provided with a preset list of performance-based assessment criteria, describing what students should do, for the task at hand. The performance-based assessment for these interactive activities revealed that higher performance of the performance-based when conducting the case studies. Flow chart for the interview session being described in Figure 1.

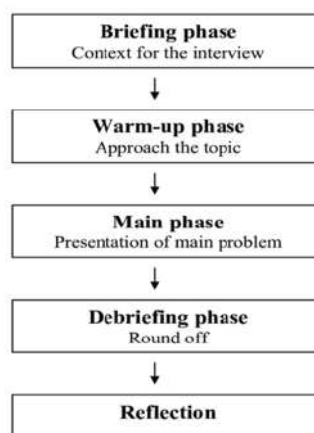

Figure 1: Flow chart for the interview assessment

It was found that the performance of the students was improved for CLO2 and CLO3 that emphasize on technical skills as compared from the previous batch is shown in Table 1.

Table 1: CLO analysis for second year students as compared to previous batch

PROGRAM	CLO1	CLO2	CLO3
SEB2 2020/2021	2.01 (Good)	3.58 (Very Good)	3.41 (Very Good)
SEB2 2019/2020	2.46 (Good)	3.23 (Very Good)	3.10 (Very Good)
SEB2 2018/2019	3.00 (Very Good)	3.5 (Very Good)	3.3 (Very Good)
SEB2 2017/2018	2.80 (Good)	3.08 (Very Good)	3.30 (Very Good)

This innovation comprises type of job skills needed in 2025 according to the World Economic Forum's Future of Jobs Report that includes problem solving, self-management, working with people and technology use and development to prepare students for their careers in future (Whiting, 2020).

Acknowledgement

The authors would like to acknowledge Faculty of Bioengineering and Technology, Universiti Malaysia Kelantan and Centre of Excellence and Academic Development, Universiti Malaysia Kelantan for the support and trainings received regarding teaching and learning activities.

References

- Aksela, M., & Hattainen, O. (2019, January). *Project-Based Learning (PBL) in Practice: Active Teachers' Views of Its' Advantages and Challenges*. Proceeding of the 5th International STEM in Education Conference Proceedings: Integrated Education for the Real World 2018, Brisbane, Australia.
- Han, S. Y., Yalvac, B., Capraro, M. M., & Capraro, R. M. (2015). In-service Teachers' Implementation and Understanding of STEM Project Based Learning. *Eurasia Journal of Mathematics, Science and Technology Education*, 11(1), 63-76.
- Kavlu, A. (2015). Project – Based Learning Assessment Methods Comparison in Undergraduate EFL Classes. *International Journal of Social Sciences & Educational Studies*. 1 (4), 47-56.
- Kokotsaki, D., Menzies, V., & Wiggins, A. (2016). Project-based learning: A review of the literature. *Improving Schools*, 19(3), 267-277.
- Whiting, K. (2020). These are the top 10 job skills of tomorrow – and how long it takes to learn them. <https://www.weforum.org>

Mar-ProD: PROJECT-BASED LEARNING APPROACH VIA INNOVATIVE PROJECT DESIGN

Mardawani Mohamad

Faculty of Bioengineering and Technology, Universiti Malaysia Kelantan, Jeli Campus, 17600 Jeli, Kelantan, Malaysia
mardawani.m@umk.edu.my

Noor Fazliani Shoparwe, Rosmawani Mohammad, Teo Pao Ter, Mohamad Najmi Masri, Wan Hasnidah Wan Osman

Faculty of Bioengineering and Technology, Universiti Malaysia Kelantan, Jeli Campus, 17600 Jeli, Kelantan, Malaysia
fazliani.s@umk.edu.my, rosmawani@umk.edu.my, teopaoter@umk.edu.my, najmi.m@umk.edu.my, hasnidah.osman@umk.edu.my

Highlights: Downstream Process and Scale up Process are core technology courses that comprises theory and practices regarding principle and application in bioindustry. Traditionally, the lectures have being delivered through conventional face-to-face (F2F) for lectures and laboratory sessions for the implementation of theory and practices of technological courses. Project-Based learning (PBL) is an instructional methodology through engaging experience by applying knowledge and skills to encourage student's engagement for collaborative learning and problem solving skills. In this invention, the concept of 'Innovative Design Project' was implemented through Project-Based Learning approach. This project was designed to suit the course objectives by introducing the application of real case studies in bioindustry. From CLO analysis (student achievement index) and course grade analysis (grade scored), it was found that student performances are improved as compared to previous batch.

Key words: Downstream process; Scale up Process; Innovative Design Project; PBL

Introduction

In this innovation, Project Based Learning (PBL) approach was applied in Downstream Process and Scale up Process Course to enhance the understanding regarding the principles and application of both courses in bioindustry. Both courses are technical core subjects for Bachelor of Applied Science (Bioindustrial Technology) that being offered in fourth and fifth semester. Downstream Process course discusses the procedures involved in obtaining materials (sources of plants, animals and microorganisms) at a level acceptable to the consumer. In Scale up Process course, the potential methods that have been used to transform laboratory information into industrial scale that involve physical and biological methods being discussed.

There are different ways to establish a creative environment that allows integration between theoretical concepts and practical aspects, together with development of students' teamwork skills. Project based learning (PBL) approach being implemented for this innovative design project. PBL method uses the concept of student-centered learning whereas students being active learners that involve planning, executing and documenting while working in groups (Aksela & Hattainen, 2019). Better implementation of PBL in practice through collaborative learning in which students and lecturers are learning from each other could enhance the interaction between students and lecturers and also promote teaching pedagogy method (Han et al., 2015). PBL is characterized by students' autonomy that refers to student centered learning, constructive investigations for the problem solving, goal-setting, collaborative learning, communication and reflection within real-world practices (Kokotsaki et al., 2016). Collaborative learning improves the student's ideas and thought regarding the execution of the project and student's abilities for teamwork as projects are often done in groups (Kavlu, 2015).

In this context, this innovative design project being developed by introducing the application of real case studies in bioindustry. This project being designed using integrated assessment to implement PBL that can lead to the development of industry relevant skills and prepare student for life long learning. In this innovation, it was observed that the decision to integrate real case studies from industry into both courses led to significant motivation for students to progress their projects. Consequently, the learning process for unit operations in bioproduct production was shown to be effective. In addition, students have improved their knowledge of process flow diagram for manufacturing process. Finally, other skills and competencies were stimulated during the PBL process, such as teamwork and the capacity to transfer what has been learned to other related disciplines.

Content

Before the innovations was introduced, the mini project regarding project design was conducted by conventional method using face-to-face (F2F). The data for the project mostly being provided by the industries for problem solving case studies and additional data obtained from previous journal articles. However, during Covid-19 pandemic, transitioning to the new normal of teaching and learning, alternative method needs to be implemented during online learning to enhance student engagement through project-based learning approach.

Through this innovation, Trello app, a visual tool for project management being used. Before the innovation being developed, a survey for the level of internet access among students was conducted to ensure that all the students' involvement for the design project by considering their internet access at home. It was found that most of the students which refers to 29 out of 44 students (65.9%) have medium internet access while 6 of them (13.6%) have

weak internet access. Only 9 out of 44 students (20.5%) have high internet access. Trello app previously being used as project management tool but in this design project, this app was implemented as project monitoring for the students and acts as platform or medium to create collaborative learning environment. In addition, this app is also simple and flexible for the students as the briefing on how to use the app as educational tool being given to the students. Bioprocess simulator, SuperPro Designer software also being used to facilitate modeling, evaluation and optimization of integrated batch and continuous processes in a bioprocessing industry.

In the case of PBL approach, tasks that need to be accomplished in the project were planned accordingly to the time given until project completion. By integrating Trello app as the platform for this PBL method, a comprehensive tasks or activities that need to undergo by the students being listed and monitored every week by the lecturers. Figure 1 shows the tasks in project design work that comprises the development of process flow diagram (PFD) for the selected bioproduct, process/unit operations involved in the upstream and downstream process and operating conditions. At the end of the project, students need to prepare a short video of their project as final presentation. Total assessment for this project is around 30% out of total mark. This project design was evaluated by two aspects which are progress work of the project (20%) and video presentation (10%) as shown in the figure.

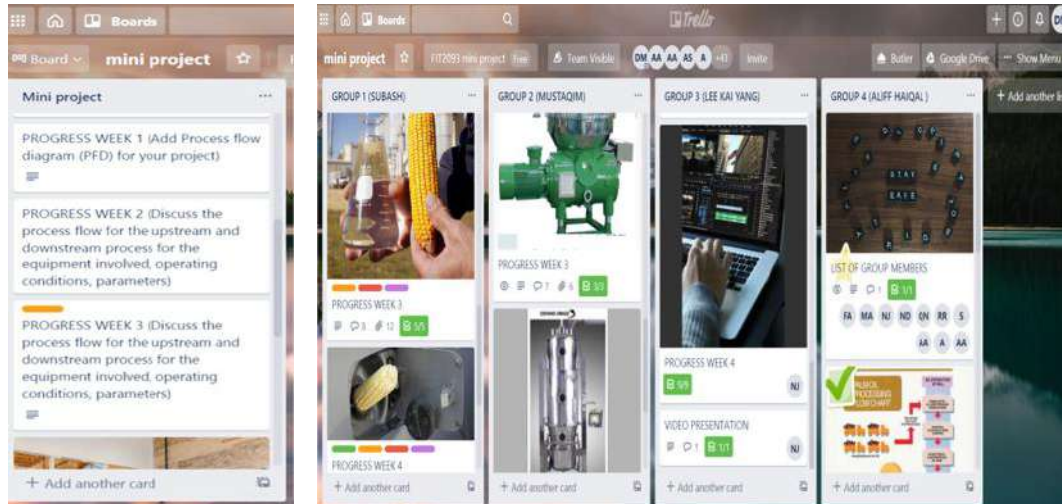

Figure 1: Tasks and progress work of project design in Trello board

Each card was allocated for each group to report their progress every week. In addition, in each card, the students or each member can participate actively for the project by discussing the progress in Trello board. The lecturer also can reply to the comments as this app also being used for the discussion platform. This platform create interaction between students and lecturers if they have any problems regarding the given tasks. Lecturer also can monitor their progress from time to time until project completion. This project was conducted to fulfill Couse Learning Outcome 3 (CLO3). Learning outcome cluster for this CLO is cluster 3D that refers to digital skills whereas the ability to use information/digital technologies to support work and studies. The skills include sourcing and storing information, processing data, using applications for problem solving and communication as well as ethics in applying digital skills. Digital skills were applied for this project design by integrating Trello app and SuperPro Designer Software. According to CLO analysis (student's achievement), it was found that the performance of the students was improved for CLO2 and CLO3 that emphasize on technical skills as compared from the previous batch is shown in Table 1.

Table 1: CLO analysis for second year students as compared to previous batch

PROGRAM	CLO2		CLO3	
Academic Session 2018/2019	Downstream	Scale up	Downstream	Scale up
*Before Invention	2.99 (Good)	3.11 (very Good)	3.08 (Very Good)	3.16 (Very Good)
Academic session 2019/2020	Downstream	Scale up	Downstream	Scale up
*After Invention	3.05 (Very Good)	3.53 (Very Good)	3.25 (Very Good)	3.30 (Very Good)

This innovation comprises type of job skills needed in 2025 according to the World Economic Forum's Future of Jobs Report that includes problem solving, self-management, working with people and technology use and development in order to prepare students for their careers in future (Whiting, 2020).

Acknowledgement

The authors would like to acknowledge Faculty of Bioengineering and Technology, Universiti Malaysia Kelantan and Centre of Excellence and Academic Development, Universiti Malaysia Kelantan for the support and trainings received regarding teaching and learning activities.

References

- Aksela, M., & Hattainen, O. (2019, January). *Project-Based Learning (PBL) in Practice: Active Teachers' Views of Its' Advantages and Challenges*. Proceeding of the 5th International STEM in Education Conference Proceedings: Integrated Education for the Real World 2018, Brisbane, Australia.
- Han, S. Y., Yalvac, B., Capraro, M. M., & Capraro, R. M. (2015). In-service Teachers' Implementation and Understanding of STEM Project Based Learning. *Eurasia Journal of Mathematics, Science and Technology Education*, 11(1), 63-76.
- Kavlu, A. (2015). Project – Based Learning Assessment Methods Comparison in Undergraduate EFL Classes. *International Journal of Social Sciences & Educational Studies*. 1 (4), 47-56.
- Kokotsaki, D., Menzies, V., & Wiggins, A. (2016). Project-based learning: A review of the literature. *Improving Schools*, 19(3), 267–277.
- Whiting, K. (2020). These are the top 10 job skills of tomorrow – and how long it takes to learn them. <https://www.weforum.org>

CREATING EXCITEMENT IN LEARNING THROUGH TIKTOK APPLICATIONS

Normaizatul Akma Saidi

Faculty of Hospitality, Tourism & Wellness, Universiti Malaysia Kelantan, Kelantan, Malaysia.
akma.s@umk.edu.my

Naziatul Aziah Mohd Radzi, Mazne Ibrahim

Faculty of Hospitality, Tourism & Wellness, Universiti Malaysia Kelantan, Kelantan, Malaysia.
aziah.mr@umk.edu.my, mazne@umk.edu.my

Highlights: Higher education is experiencing tremendous impact due to COVID-19 pandemic. This pandemic reshaped the way education is delivered. The sudden shift from face-to-face to online learning has raised critical concern on students' engagement. Students' engagement becomes the priority of most educators since it relates to students' achievement. The application of TikTok in teaching delivery is able to bring an excitement in learning among students and enhance students' engagement. Thus, this study offers insights towards new forms of teaching delivery, specifically in terms of reflective learning that have the potential to engage students more fully.

Key words: *higher education, teaching delivery, students' engagement, achievement, TikTok.*

Introduction

Many countries worldwide transferred education from face-to-face into remote teaching responding to the state of emergency to fight the outreach of Coronavirus (hereafter COVID-19). Emerging technologies strongly influence the learning environment in higher education settings whether using these tools on campus, blended, or fully in online environments (Czerkowski & Lyman, 2016). These technologies reshaped student engagement for learning through new features that enable learners and instructors to communicate synchronously and asynchronously (Bergdahl et al., 2020).

Visual social media such as Instagram, Snapchat and TikTok are increasing in popularity and have become a significant part of visual culture among the youth generation (Literat, 2021). Social media gives different effects to different spheres of society such as politics, economy, sport, communication, and education. Yet, it has an ongoing influence and has become essential in all areas of life among university students. Hence, it is essential to understand the educational potential of social media, owing to the widespread popularity of social media among students (Escamilla-Fajardo, Alguacil & Lopez-Carril, 2021).

Content

1. Description of Innovation in Teaching Delivery

The most common aspects of student's online engagement (synchronously and asynchronously) are communicating with peers and the instructor, participating in the online class activities, being a knowledge producer (recording a short video to explain an idea, designing a PowerPoint presentation) and the efforts that students make in their learning environment (Khlaif, Salha, & Kouraichi, 2021).

This study applied TikTok as one of the students' engagement methods. TikTok is a social media app focusing on short video sharing. Users can take advantage of an assortment of templates, filters, and visual effects, as well as a built-in music library, to create short videos. The most popular video genres are lip-syncing, dancing, or acting out comedic skits set to 15-second music clips.

2. Background of TikTok as Innovation in Teaching Delivery

With over 800 million monthly users, TikTok has experienced a meteoric rise, becoming the most downloaded app of 2020; in the United States, it has seen a 375% year-on-year growth. The app is particularly popular with youth aged 13- to 24-year-olds who represent 69% of the TikTok's user base and plays a significant role in young people's social and cultural lives, both reflecting and shaping youth culture (Sehl, 2020).

Wong and Chong (2018) defined online engagement as a unique collection of active and collaborative learning, participation in enriching learning activities, communication with teachers and among learners, involvement in educational experiences, and feeling supported.

3. Importance of TikTok in Education

Short videos are increasingly popular in social media because they can capture memorable moments in formats that range from a few seconds to several minutes (Zhang, Wu, & Liu, 2019). Indeed, videos have succeeded in capturing society's attention on Instagram, Facebook, Snapchat and, currently, TikTok. By using TikTok, it promotes peer-to-peer teaching through TikTok's videography features.

4. Advantages of TikTok towards Education and Community.

The main advantage of TikTok over other applications (e.g: Snapchat) is that the video can be shared through different applications, which allows it to reach people who do not have a TikTok account (Hayes, et al., 2020). TikTok could add insight into young people's practices of sharing their formal educational experiences in online social spaces. TikTok stands out owing to its focus on music; it offers the latest music trends, various special effect filters, video editing tools, and stickers (Zhang et al., 2019). The application of Tik Tok perhaps led to student engagement, enhance students' performance, and improve the learning process in an online learning environment.

5. Commercial value of TikTok in Teaching Delivery

The usage of TikTok application in learning is able to generate a further advantage to many social aspects such as social and economic to educators and students. From a social aspect, the application of TikTok in the learning process could improve the quality of education and create exciting new environments and cultivate creativity among educators and students especially for courses that require a complex understanding from students. It brings a new perspective of the education landscape. Thus, the learning process would be something that they wait for and no longer be bored than the conventional process of learning they were involved in.

Acknowledgement

We would like to thank the Faculty of Hospitality, Tourism and Wellness for the support and encouragement to participate in the innovation carnival.

References

- Bergdahl, N., Nouri, J., Fors, U., & Knutsson, O. (2020). Engagement, disengagement and performance when learning with technologies in upper secondary school. *Computers & Education*, 149, 103783.
- Czerkowski, B. C., & Lyman, E. W. (2016). An instructional design framework for fostering student engagement in online learning environments. *TechTrends*, 60(6), 532-539.
- Escamilla-Fajardo, P., Alguacil, M., & López-Carril, S. (2021). Incorporating TikTok in higher education: Pedagogical perspectives from a corporal expression sport sciences course. *Journal of Hospitality, Leisure, Sport & Tourism Education*, 28, 100302.
- Hayes, C., Stott, K., Lamb, K. J., & Hurst, G. A. (2020). Making every second count. Utilising TikTok and Systems Thinking to Facilitate Scientific Public Engagement and Contextualization of Chemistry at Home, 97(10), 3858–3866.
- Khlaif, Z. N., Salha, S., & Kouraichi, B. (2021). Emergency remote learning during COVID-19 crisis: Students' engagement. *Education and information technologies*, 1-23.
- Literat, I. (2021). "Teachers Act Like We're Robots": TikTok as a Window Into Youth Experiences of Online Learning During COVID-19. *AERA Open*, 7, 2332858421995537.
- Sehl, K. (2020). important TikTok stats marketers need to know in 2020. Hoosuite Blog.
- Wong, A., & Chong, S. (2018). Modelling adult learners' online engagement behaviour: Proxy measures and its application. *Journal of Computers in Education*, 5(4), 463-479.
- Zhang, X., Wu, Y., & Liu, S. (2019). Exploring short-form video application addiction: Socio-technical and attachment perspectives. *Telematics and Informatics*, 42, 101243.

PKB-JOBLINK

Aslamaitulakma Mohamad

Politeknik Kota Bharu, Kelantan, Malaysia
aslamaitul@pkb.edu.my

Norhidayah Mohamad Yusop, Roslina Idris

Politeknik Kota Bharu, Kelantan, Malaysia
norhidayah@pkb.edu.my; roslinaidris@pkb.edu.my

Highlights: Corporate Industry Services and Employability Centre (CISEC) at Politeknik Kota Bharu (PKB) is an institution that monitors graduates' marketability and serves as a mediator for PKB's industry engagement. Our group, ASDALIN, is attempting to assist the CISEC Unit with PKB issues by bringing industry together with PKB graduates from diverse disciplines such as management, accounting, electrical, and mechanical engineering. The PKB-Joblink system was created as a consequence of mind proliferation utilising 5W1H and Brainstorming (Brain Writing) techniques. This group has also given questionnaires to five industries and five students who have utilised the PKB-Joblink system for feedback. The findings of the survey were evaluated, and it was discovered that 90% of the industry is satisfied with the system. While 80% of students gave favourable feedback, they also offered several ideas for improvement. This PKB-Joblink innovation has a significant influence on the manner of formally delivering information to students, saving both money and time while also improving excellent relations between industries, and PKB graduates.

Keywords: *Politeknik Kota Bharu, CISEC, PKB-Joblink, system*

Introduction

Politeknik Kota Bharu (PKB) has a special unit called Corporate Industry Services and Employability Centre (CISEC). This unit role has been expanded in line with the Government Transformation Plan, National Higher Education Strategic Plan and Polytechnic Transformation Plan. Key Performance Indicators (KPI) in the Polytechnic Transformation Plan which targets Malaysian Polytechnics is recognised as the leader in technical and vocational education and training at the regional level, 90 percent of working polytechnic graduates (including further education) within six months of completing their studies and 50 per cent of student from Sijil Pelajaran Malaysia, choosing polytechnic as the first choice clearly demonstrates the importance of CISEC's role in Polytechnics.

CISEC needs a system that can be usable online to handle the big data of student graduates and efficiently traceable. CISEC needs the system that can meet the opportunity to collaborate with industry around PKB and to provide advisory services from Graduate Career Officer and Employment Availability Officer. CISEC wants to create a platform that makes it easy to announce anything about career opportunities through the Career Carnival annually because this is important to students to expose the field of employment and opportunities to further their studies after diploma level studies.

Description

To identify significant difficulties in the CISEC unit, our group employed the Brainstorming (Brain Writing) approach and 5W1H approach has been used to outline the key issues, Who - PKB CISEC Unit Officers, Industry, Academic Advisors and All PKB Graduates, When - All the time, every time the industry needs employees from among PKB graduates, What - Difficulty in connecting industry and PKB graduates to fill vacancies, Why - There is no platform that allows the industry to advertise workforce needs and allows the industry to obtain graduate data to contact, Where - CISEC Unit, Politeknik Kota Bharu, Kok Lanas, Ketereh, Kelantan, and How -The industry can get a selection of academically qualified candidates, in the required fields directly, quickly and transparently by using PKB-Joblink.

The system was created by a Programmer in the Department of Student Affairs PKB who is experienced in building systems and utilising the PKB server. The mechanism has been operational since 2019 and has been tested every time to time after the industry posts their job vacancies for PKB graduates. Questionnaires were emailed via Google Forms to the email addresses of five industries and five students who had previously utilised this method. Periodically, system upgrades have been done to increase the system's quality and efficiency.

Background of The Innovation

CISEC Unit's officer has difficulty disseminating job advertising from the industries to PKB's graduates and she needs a platform as a mediator to match industries job vacancies with the candidates from PKB's graduates. Therefore, using the Brainstorming method, we identified three related problems, there are: 1. The activity of disseminating job vacancy advertisements to PKB graduates through the Academic Advisor, there are constraints where the Academic Advisor no longer has a relationship with PKB graduates, 2. There are graduates who have changed their personal contact information and 3. The industry only gets candidates to be interviewed only after students get the information from advertisements disseminated by Academic Advisors, taking a long time.

This system connects to the PKB website, allowing students and companies to log in to PKB-Joblink by clicking this link. To access or log in, industries must notify the CISEC officer who serves as the system's administrator. Then, based on the employment requirements, they may choose the graduates they require.

After this part was done, the CISEC officer deactivated the companies' access to the system once more. The firm may only access essential information about students, such as their name, address, field of study, academic success, phone number and email address to protect the security of their personal data.

The Importance of Innovation

The importance of the PKB-Joblink system is that it serves as a platform for the industry to find candidates more efficiently and successfully fill job vacancies in their industries, this PKB-Joblink also important as well as a platform for job searchers and collaboration between PKB and the industry. CISEC officers can use this system as a forum to discuss the accomplishments of students that they have hired as workers.

Advantages of the innovation

The advantages and benefits of this system include the ability to speed up the selection of eligible applicants in the disciplines required by the industry, as well as the ability to choose qualified individuals in accordance with the industry's requirements, to simplify the process of spreading industry advertising directly to PKB graduates, to permit two-way contact between industry and officials of PKB's CISEC section and to prevent information from being leaked to graduates looking for work.

Commercialisation

The PKB-Joblink system will be able to share it with polytechnics and community colleges in Malaysia, as well as distribute its usage to other skills training centres. This system was already test run at Politeknik Jeli, Kolej Komuniti Kok Lanas and Kolej Komuniti Pasir Mas. UiTMKB is also interested in PKB-Joblink when they join our shared knowledge about that.

Acknowledgement

We are grateful to Mr. Azmi bin Juadi @ Rosbi the programmer of this system and to Mrs. Noor Hazini binti Ab Halim, CISEC Officer of Politeknik Kota Bharu, Kelantan.

References

- Hansen, B. (16 may, 2018). *Wrike*. Retrieved from 7 Techniques for More Effective Brainstorming: <https://www.wrike.com/blog/techniques-effective-brainstorming/>
- PKB-Joblink*. (2021). Retrieved from We Offer Our Students For Vacancies: <http://spmp.pkb.edu.my/aaasyarikat/firstpage.jsp>
- Politeknik Kota Bharu*. (2021). Retrieved from PKB-Joblink: <https://pkb.mypolycc.edu.my/index.php/ms/>

THE SIMULATION IN VIRTUAL LEARNING FOR PRACTICAL COURSES: A PROPOSED IDEA

Mazne Ibrahim

Faculty of Hospitality, Tourism and Wellness, Universiti Malaysia Kelantan, Kelantan, Malaysia
mazne@umk.edu.my

Naziatul Aziah Mohd Radzi, Normaizatul Akma Saidi

Faculty of Hospitality, Tourism and Wellness, Universiti Malaysia Kelantan, Kelantan, Malaysia
aziah.mr@umk.edu.my, akma.s@umk.edu.my

Highlights: The Covid-19 pandemic has changed a landscape of education. Fortunate enough that technological aspects grow in parallel to demand where teaching can be conducted fully online. However, certain courses especially on practical courses like hospitality and wellness courses, where educators and students are facing a constraint as they were not able to demonstrate and physically practise a method that consists in syllabus. Thus, the simulation of virtual learning for hospitality and wellness as well as the other practical courses are highly desired to ensure an ease of learning process for those courses. This abstract will briefly discuss a proposed idea of a virtual learning method that consists of the conceptual background, usefulness, potential and further work.

Key words: *virtual learning, practical course, hospitality, wellness, propose idea*

Introduction

During Covid-19 pandemic, educators and students have no other choice but to have their lesson online for the sake of the safety and wellness of individuals. The intensity of the educational process increases, it also becomes more dynamic and continuous (a principle of lifelong learning), and educational technologies are changing accordingly. This situation has led to a high demand of technological applications and educators have to be creative and innovative to ensure their learning process is smooth, interesting and effective to students. However, a practical oriented course like in hospitality and wellness courses are facing a challenge since educators can only demonstrate, but students could not be able to experience a real situation for their further understanding and ability to apply. Simulation Virtual Learning Environments (VLE) hopefully could bridge the gap and help educators for a more effective learning process.

Description of Innovation

According to Douglas and Miller (2006) computer-based simulations have been used as an instructional tool to help reinforce hospitality concepts and lessons and the dynamics of interdepartmental relationships. This kind of learning method encourages students to become active learners functioning in various capacities. The simulations through virtual learning have an objective to imitate aspects of real-life situations, virtual environments empower students in such a way that they can more fully appreciate how to apply theories and concepts learned in reality. The simulation of virtual learning allows individuals to be familiar with the system, producing an interaction that could create a sense of reality.

The background of Innovation: Virtual Learning Environment (VLE)

Simulation in Virtual Learning Environment (VLE) consists of several features such as designed information space, social space since educational interactions occur in the environment turning spaces into workplaces, explicitly represented (this information representations can vary from text to 3D immersive worlds, students are not only active participants but they also actors, integrating heterogeneous technologies. The VLEs are used to support teaching and learning. It adapts learning just like in a face-to-face teaching or a physical classroom and it ranges from information delivery; peer support; organizing a group work; self-assessment; formative / summative assessment; teacher-student communication; and tutorials. VLEs provide a range of tools to secure the same teaching and learning principles like traditional classroom.

Advantages of Innovation and Commercial Value

The invention of this product is able to generate a further advantage by providing a value to social and economic among educators, students and community as a whole. From a social aspect, if the simulation of virtual learning becomes commercialized it could improve the quality of education especially to the practical taught course in hospitality such as Food and Beverage Management, as well as Spa Massage and Therapy for wellness courses. It brings a new perspective of the education landscape. This invention may provide an economic benefit to local programme developers that can create job opportunities for them.

Simulations in Virtual Learning Environment (VLE) provide authentic learning experiences that display real world problems and enable students to practise and develop graduate capabilities, technical skills and strategic decision-making skills. Emerging technologies, supported by increased bandwidth, have created new opportunities for online and cloud-based simulations and provide improved flexibility and portability for students. Simulations also hold some promise of complementing other innovations in online education, including Massive Open Online Courses (MOOCs), (Benckendorff et al., 2015).

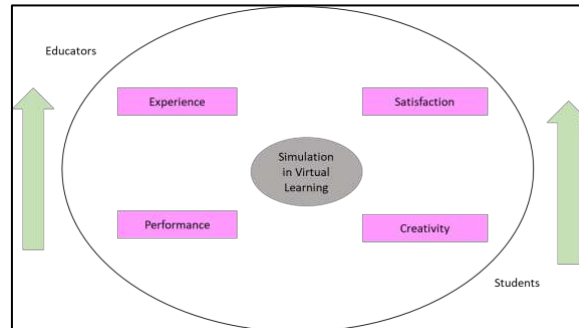

Figure 1: A Framework of Simulation of Virtual Learning toward Educators and Students, adapted from Benckendorff et al., 2015

Figure 1 shows a framework of simulation of Virtual Learning toward Students where the application of Simulation of Virtual Learning could increase many aspects such as experience, satisfaction, performance and creativity for educators as well as students.

Acknowledgement

We would like to thank the Faculty of Hospitality, Tourism and Wellness for the support and encouragement to participate in the innovation carnival.

References

- Benckendorff, P., Lohmann, G., Pratt, M. A., Whitelaw, P. A., Strickland, P., & Reynolds, P. (2015). Creating Educator Resources for Online Simulation-Based Pedagogies in Tourism and Hospitality. *CAUTHE 2015: Rising Tides and Sea Changes: Adaptation and Innovation in Tourism and Hospitality*, 67.
- Douglas, A., & Miller, B. (2006, January). Experiential learning: Empowering Students in An Interactive Online Hospitality Simulation Environment. In *11th Annual Hospitality and Tourism Graduate Student Education and Research Conference*.
- Pererva, V., Lavrentieva, O., Lakomova, O., Zavalniuk, O., & Tolmachev, S. (2020). The Technique of The Use of Virtual Learning Environment in The Process Of Organizing The Future Teachers' Terminological Work By Specialty.

GAMIAPP:
USING GAMES IN WHATSAPP TO INCREASE PUPILS' ENGAGEMENT IN ENGLISH PDPR

Siti Hajar Akma Mohd Rawi

Sekolah Kebangsaan Chicha Tinggi, Pasir Mas, Malaysia
hajar.shamr@gmail.com

Mhd Hafiz Karami Mhd Zain

Universiti Malaysia Kelantan, Bachok, Malaysia
hafiz.k@umk.edu.my

Highlights: This abstract present how the usage of various games in WhatsApp can increase pupils' engagement to support a blended learning English class through active learning during teaching and learning at home (PdPr). WhatsApp is used as a tool for the teacher to carry out the lesson because it requires low-bandwidth.

Key words: *pupils' engagement, WhatsApp, games, English, PdPr, remote learning*

Introduction

Due to Covid-19 pandemic, the urgent need for emergency remote learning and teaching emerged and the teachers who are not trained to teach fully online before have to adapt their teaching plan to the new norm. The pupils are also having to adjust themselves to quickly familiarise themselves to online learning. Another challenge for this remote learning is the inequality of technology access especially among the pupils from low-income family and those who live in rural area (LoBue, 2020).

As cited from Rambe & Crispen (2013), "WhatsApp instant messaging has potential to bridge information divides between educators and students". This is because WhatsApp is user-friendly and even the 7-year-old pupils are familiar with its function. Moreover, WhatsApp is a free app and almost all Malaysian has it. A statistic report has shown that as of May 2020, 98.7% respondents from Malaysia stated that WhatsApp is their favourite communication application (Muller, 2021, April 07).

English is one of the core subjects in school. In some parts of Kelantan, English is considered as the third language, after the Kelantanese dialect and Bahasa Melayu. Some refer to English as a killer subject. Therefore, it is quite hard to get the pupils to be interested in this subject because of the preconceived belief that English is a difficult subject.

Therefore, the teaching and learning English at home proves quite a challenge, especially to get the pupils to respond to the teacher in WhatsApp group during 'class'. This study presents the use of games that can be carried out in WhatsApp group to increase pupils' engagement through active learning in English class.

Description

The games chosen are games that do not require any cost and involved all pupils. Along the game, the teacher will be as a facilitator as well motivates the pupils to participate.

Gamification, however, is not directly associated with pupils' knowledge and skills. On the other hand, "gamification affects students' behavior, commitment and motivation, which can lead to improvement of knowledge and skills" (W. Hsin-Yuan Huang, D. Soman, 2013). The game itself serves as reward after the pupils finish their tasks for the lesson that day.

The selected games integrated with this WhatsApp class are:

1. **Emoji in Countable and Uncountable Nouns** – during the post lesson, as a closure and solidification activity, the teacher ask the pupils to emojis to list the countable nouns and uncountable nouns. The pupils had fun to find the emojis instead of just writing or typing the words.
2. **Guess the Emoji Game** – this game is can be used as induction activity, closure and even time fillers. The teacher will give some emojis and the pupils have to guess the phrase. It can be used to guess the idioms, a movie name, phrasal verbs, compound nouns, etc.
3. **Scavenger Hunt** – this game promotes active learning among the pupils. It can be carried out in many topics such as comparative adjectives, vocabulary, as well as contextual learning. For example, the text discussed is about Malaysia, so the pupils are given 5 minutes to find at least 3 items around their house that remind them of Malaysia. Then, they have to take a picture of the items and share it in the group. For younger learner, year 1, for example, the teacher can ask the pupils to find 5 items with red colour for the colours topic.
4. **Who Wants to be a Millionaire** – the template of the game in PowerPoint can easily be downloaded from the internet. The teacher just have to modify the questions to suit the topic learned. It can also be used as topical

assessment. This game is ideal to be used during Google Meet, but the teacher can use it in WhatsApp to by exporting the slides into jpeg files and upload the questions then the answers into the group.

5. **Crack the Code!** – the pupils are given jumbled up words related to the vocabulary or themed that will be learned that day. The fastest pupil who can solve it is the winner.

Context

The project is carried out among the Year 4, 5 and 6 Kenanga pupils of Sekolah Kebangsaan Chicha Tinggi, Pasir Mas, Kelantan in English class. Because of prolonged PdPr and the unfamiliarity of having lesson remotely, the pupils have lost focus. More and more pupils 'showed up' less in the class WhatsApp group every day. The initial problems are internet coverage and having to share the gadgets with their siblings who are also involved in PdPr.

However, the recent phone calls made to the parents showed that even those who have their own mobile phone did not showed up in class. Most of the pupils feel bored and somewhat overwhelmed with the PdPr 2.0 timetable which requires them to have more than 4 subjects in a day.

It is important to keep the pupils' interest and engagement so as to keep them motivated to follow the lesson. Most of the games are used to solidify the lesson for that day, in a fun way.

Advantages of Using Games in WhatsApp Class

- Keeps the pupils engaged and respond during 'class' in WhatsApp Group.
- As extrinsic motivation for them to complete the learning tasks that day.
- Those who are initially act as silent readers also involve in the game.
- Motivates them to participate in class and do the assignments because in order for them to 'win' the games, they have to be prepared as the games usually related to the lesson learned.
- it's free. No cost included except for the internet data.
- Easy to be prepared by the teacher and not time consuming.
- User-friendly. The pupils need not to be an IT-savvy to participate in the game.

References

- Gillingham, M. G. & Topper, A. (1999). Technology in teacher preparation: Preparing teachers for the future. *Journal of Technology & Teacher Education*, 7(4), 303-321.
- Rambe, P., & Crispen C. (2013). Using mobile devices to leverage student access to collaboratively-generated resources: A case of WhatsApp instant messaging at a South African University. In 2013 International Conference on Advanced ICT and Education (ICAICTE-13). Atlantis Press.
- W. Hsin-Yuan Huang, D. Soman. (2013, December 10). Gamification of Education. Toronto: University of Toronto. Retrieved from Inside Rotman: <http://inside.rotman.utoronto.ca/behaviouraleconomicsinaction/files/2013/09/GuideGamificationEducationDec2013.pdf>
- Amy LoBue (2020). Low-bandwidth teaching strategies in response to the COVID-19 pandemic: addressing technology access inequity in distance learning and online education. Harvard Graduate School of Education. Retrieved June 20, 2021 from https://edredesign.org/files/edredesign/files/low_bandwidth_teaching_strategies_2.pdf?m=1596823789
- Joschka Muller (2021). Share of internet users using communication applications in Malaysia as of May 2020, by app. Retrieved June 20, 2021 from <https://www.statista.com/statistics/973428/malaysia-internet-users-using-communication-apps/#statisticContainer>

APPLICATION OF THE KIRKPATRICK MODEL: EFFECTIVENESS IN ACCOUNTING COURSE

Normaizatul Akma Saidi

Faculty of Hospitality, Tourism and Wellness, Universiti Malaysia Kelantan, Kelantan, Malaysia
akma.s@umk.edu.my

Noraida Saidi¹, Derweanna Bah Simpong², Nur Azimah Othman², Hazyati Hashim², Nadzirah Mohd Said², Wan Farha Wan Zulkiffli³,

¹Faculty of Accountancy, UiTM Kelantan Branch, Kelantan, Malaysia

²Faculty of Hospitality, Tourism and Wellness, Universiti Malaysia Kelantan, Kelantan, Malaysia

³Faculty of Entrepreneurship and Business, Universiti Malaysia Kelantan, Kelantan, Malaysia

noraida069@uitm.edu.my, derweanna@umk.edu.my, azimah.o@umk.edu.my, hazyati@umk.edu.my,
nadzirah.ms@umk.edu.my, farha@umk.edu.my

Highlights: The Coronavirus pandemic has affected educational systems worldwide, leading to the widespread closure of schools and higher institutions in the affected countries. This pose challenges to the students especially in learning calculation subject through online. The accounting subject is being regarded as killer subject by some students. The failure rate for this subject is quite high prior the COVID-19 pandemic when traditional face to face classes is present. Therefore, this study is keen to know the effectiveness of the model for the accounting subject since learning accounting via online is very challenging. The methodology of this study is quantitative survey administered through Google forms to students who take accounting subject. This study examined the effectiveness of the accounting course by using four essential elements of the Kirkpatrick Model (Reaction, Learning, Behaviour and Results). The novelty of this study is the application of the Kirkpatrick Model pre- and post-learning process in order to highlight the differences of outcome throughout the learning process.

Key words: Accounting, online learning, COVID-19, challenges, effectiveness.

Introduction

This model was developed by Dr. Donald Kirkpatrick (1924 – 2014) in the 1950s. The model can be implemented before, throughout, and following training to show the value of training to the business. This evaluation model involved four level (as depicted in Figure 1); 1) Level 1; it evaluates how individuals react to the training model by asking questions that establishes the trainees' thoughts; 2) Level 2; to gauge the level of participants that have developed in expertise, knowledge, or mindset; 3) Level 3; this level analyzes the differences in the participant's behavior after completing the course; and 4) Level 4; determines the overall success of the training model.

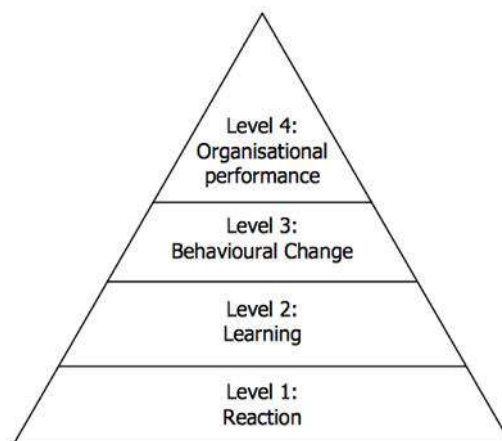

Source: from Kirkpatrick, 1996

Figure 1: The Kirkpatrick Model

The Kirkpatrick Model in teaching evaluation

The Kirkpatrick Model was created by Dr. Donald Kirkpatrick as a model for measuring training and development effectiveness. Originally pictured for corporate training. But little is known about the effectiveness of the model in measuring and assessing the accounting course. Therefore, this study applying the model to this accounting course in order to minimize the failure rate and improve the level of knowledge of the targeted student.

Background of the Kirkpatrick Model in teaching evaluation

Previous research in education specifically on the effectiveness and development has highlighted the vital role plays by educators in making educational institutions more effective and more successful in carrying out their duties and responsibilities. Subsequently, there are training programmes organised by educational institutions to help educators to perform their tasks and responsibilities effectively. Nevertheless, the evaluation of the training (the final stage of training), which plays a critical role in measuring training outcomes; commonly either marginalised or ignored (Alsalamah & Callinan, 2021). This represent barriers to the effectiveness of the training since room for improvement for both related parties largely being closed and ignored.

Importance to education

Kirkpatrick's Four-Level Training Evaluation Model can help educators to know their students' level of knowledge. By knowing this, the students can be categorized according to their level for better knowledge sharing and delivery of ideas. In addition, the educators also know how and where to improve in terms of teaching delivery process in order to ensure the knowledge delivered effectively. Hence, the improvement in learning process and environment perhaps being done smoothly in the future. Finally, the students' achievement is promising in the future by having this evaluation.

Advantages of the Kirkpatrick Model in teaching evaluation towards education and community.

Firstly, able to identify the level of knowledge among student for specific topic. Secondly, able to categorize the students based on their level of knowledge. Lastly, able to improve the level of knowledge and grade of students.

Commercial value of the Kirkpatrick Model in teaching evaluation

This application of the Kirkpatrick model hopefully brings some light on the students' achievement in the future. In addition, both related parties will have room for improvement in either teaching delivery and learning process. Hence, this evaluation highlights the vital roles of the educators in educational institutions for better future.

Acknowledgement

We would like to thank the Faculty of Hospitality, Tourism and Wellness for the support and encouragement to participate in the innovation carnival.

References

- Kirkpatrick, D. (1996). Great ideas revisited. *Training & Development*, 50(1), 54-60.
- Alsalamah, A., & Callinan, C. (2021). Adaptation of Kirkpatrick's Four-Level Model of Training Criteria to Evaluate Training Programmes for Head Teachers. *Education Sciences*, 11(3), 116.

GET2GETHER: THE WEB-APP THAT CAN WORKS WITHOUT THE INTERNET

Azlin Sharina Abdul Latef

Universiti Malaysia Kelantan, Bachok, Malaysia
azlinsharina@umk.edu.my

Nuzul Haqimi Muhammad, Hana Yazmeen Hapiz, Sarah Wahida Hasbullah,

Mohd Zaimmudin Mohd Zain

Universiti Malaysia Kelantan, Bachok, Malaysia
nuzulhaqimi@umk.edu.my, hana@umk.edu.my, sarahwahida@umk.edu.my, zaimmudin@umk.edu.my

Highlights: Malaysia has long recognised the importance role of Information and Communication Technology (ICT) to encourage the national development. The government support for the use of technology in education was strengthened by the launch of 1Bestari.net in 2012. Through this project, over 90 per cent of public schools in Malaysia were equipped with Internet access (PEMANDU, 2014). In 2017, the government confirmed that almost seventy per cent of the rural schools in Malaysia were provided with Internet broadband (Bernama, 2017). However, the research done through this study has found out that even though the rural schools were installed with Wi-Fi router, the Internet connectivity was very low and unstable. Therefore, this study aimed to design a system which is affordable and able to meet this condition. The teachers and students are able to communicate and use the proposed system by connected to the school's Wi-Fi, with or without the Internet connection.

Key words: *Rural schools, Information and Communication Technology (ICT), Information and Communication Technology for Development (ICT4D), Interaction Design, Digital Storytelling*

Introduction

Malaysia has introduced various programs to support the integration of ICT in education. These included some of the major ICT schemes such as of the Smart School Project, computer laboratories in schools including those in remote areas, WebTV and school access centres (Shamsuddin, n.d). The government's objective to bridge the educational and digital gap between rural and urban students can be seen through the various proposals outlined in the Malaysia Education Blueprint 2013- 2025, which aimed to meet the requirements of rural students including aboriginal (Malaysia Education Blueprint, 2013). However, despite innumerable initiatives taken by the government to reduce improve the ICT access in Malaysia, certain parts of the country are still lack behind others in terms of the ICT use and access, especially those in rural areas. Study conducted by Malaysian Communications and Multimedia Commission (MCMC) reported that rural users only accounted for 30% of approximately 28.7 million Internet users in Malaysia (Malaysian Communications and Multimedia Commission, 2018).

The COVID-19 pandemic that hits the world in 2020 has not just affected the normal ways of living but also affected the education landscape. The lockdown implemented in Malaysia since March 2020, has affected many sectors to temporary closed including the education sectors. The school closures have affected 8 million students in Malaysia (Azahar, 2020). In order to prevent the students from falling behind in their studies, Malaysia's Ministry of Education has demanded that online learning should be carried out to replace the face-to-face classes (Ministry of Education, 2020). However, a report by the government news agency has revealed that Internet services in rural areas are extremely limited and unstable, causing difficulties for rural students to join online classes (Kamarudin, 2020). This COVID-19 pandemic has clearly alerted the government to seriously take into account the importance of online teaching and learning as not all students are benefited from it due to lack access to broadband Internet infrastructure especially for those living in remote areas, even though online learning has long been introduced in Malaysia (Kamarudin, 2020). A study also reported that synchronous learning is not suitable for students in rural areas with unstable and low Internet connectivity, causing them to lose interest and lagging behind in learning compared to those who live in the urban areas with stable and strong Internet connection. Therefore, asynchronous learning is suggested to help learning for students with low Internet connectivity (Karim, 2020). These situation raises the question as to what types of system or application can be developed to help addressing the issue? What kind of system or applications that is low cost and scalable can be designed and developed?

System Development

Digital storytelling involves the creation of short multimedia narratives and has been shown to be useful in classroom settings. Besides being able to engage the students in conventional learning, digital storytelling is also reported to support digital literacy, and communication with and between semi-literate students. Building on this work, this study introduces a cross-platform digital storytelling application for rural students in Malaysia, called Get2Gether. The goal of this system was to stimulate creativity and promoting collaboration among the students by allowing them creating their own digital stories, incorporating the use of images, videos, drawing, text and sound. After deciding the kind of system that we were intended to develop, we need to define the platform that is suitable to run the system.

A web-based application is considered due to the limited Internet connectivity in the rural schools. However, the system can also be accessed via various platforms (tablet, smartphones, etc). The system can be used anywhere as long as there is a connection between the client and the server, provided the coverage is sufficient. Various studies have revealed that collaboration promotes active learning, student engagement as well as enhances creativity. Therefore, the system was developed to accommodate collaboration between the students as they connected to same network. We designed our web server that can be injected into the school network and accessed by the devices in the same network, in order to solve the problem with the Internet connection. This allowed teaching and learning activities to be conducted anywhere in the school or within the area covered by the network. The server also must have the ability to synchronise with a cloud server that can be accessed through the Internet. This would help ensure that the system can be used in collaboration with other schools in the future, provided there is a reasonably good Internet connection. According to recent data from the government, there are 873 community Internet Centre nationwide for the rural communities (Berita Harian, 2021). Therefore, most of the students of the rural school come from the same community or village, Get2Gether can also be installed at the community Internet centre at the village. Consequently, the students are able to access to the system as long as they connected to the community Internet centre wireless network eventhough the Internet connection is low or unstable.

Figure 1 How devices connected to the system

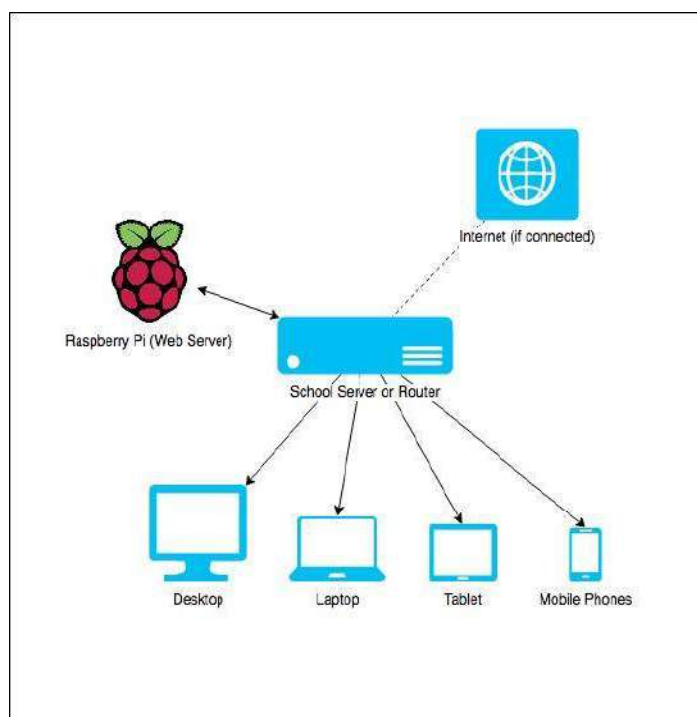

The System Features

Get2Gether was designed and developed based on the rural schools' environment and the rural students' requirements. The main novelty of Get2Gether is that it can work with limited Internet connectivity. Research done at two of the rural schools in Kelantan showed that literacy was one of the main problems at the rural schools. Hence, the interface design is simple with less text. This is to facilitate the illiterate and semi-literate students. Besides that, Get2Gether incorporated multiple media such as text, video, audio, drawing, etc. This is to stimulate the students' learning and creativity by creating their stories using those media. As most of the rural students come from the low-income families, they cannot afford to own smartphones or tablets and totally depend on the school computers. Thus, Get2Gether was developed as a multi-platform or cross-platform web application so that the students are able to use the system via any devices. The students are also able to collaborate with each other in order to create their stories with multiple devices as long as they are connected to the same Wi-Fi connection. Therefore, Get2Gether helps to promote collaboration and students' engagement.

As the conclusion, this innovation will help to make use of the current Internet facilities available in the school or in the villages even though the Internet is unstable or has low connectivity. It also helped to improve digital literacy among the students in rural areas as well as promoting online learning. Besides that, through Get2Gether, rural students are exposed to collaborative learning which helps to enhance their creativity and engagement.

System Commercialisation

This project aims to help rural education in Malaysia in terms of narrowing the digital gap by increasing digital literacy and promoting the usage of ICT in education. This is in line with the Malaysian Ministry of Education (MOE) goal stated in Malaysia Education Blueprint 2013- 2025. The Malaysia Digital Economy Corporation (MDEC), is also actively investing in the success of the use of ICT among rural schools. Therefore, we believed collaborating with MOE and MDEC via this research will help to boost the ICT usage among rural schools in Malaysia.

References

- Astro Awani. (2017, April 25). Lebih 7,000 sekolah luar bandar nikmati khidmat internet jalur lebar. *astroawani.com*.
<https://www.astroawani.com/berita-malaysia/lebih-7000-sekolah-luar-bandar-nikmati-khidmat-internet-jalur-lebar-140582>
- Azahar, N. S. (4, 2020). Distant learning a new normal in education. *Distant learning a new normal in education*. Berita Harian. (2021, May 17). Pusat internet KOMUNITI SEDIA capaian internet BANTU Transformasi Kehidupan penduduk. Berita Harian. <https://www.bharian.com.my/bisnes/teknologi/2021/05/817535/pusat-internet-komuniti-sedia-capaian-internet-bantu-transformasi>.
- Malaysian Communications and Multimedia Commission. (2018). Internet users survey 2018: Statistical brief number twenty-three. *Internet users survey 2018*, 1–39. Retrieved from <https://www.mcmc.gov.my/skmmgovmy/media/General/pdf/Internet-Users-Survey-2018.pdf>
- Malaysia Education Blueprint, M. (2013). *Malaysia Education Blueprint 2013 - 2025*. Tech. rep.
- Malaysia Ministry of Education. (2020). Kenyataan Media: Pelaksanaan Pengajaran dan Pembelajaran berikutan Peralihan Tempoh Perintah Kawalan Pergerakan. *Kenyataan Media: Pelaksanaan Pengajaran dan Pembelajaran berikutan Peralihan Tempoh Perintah Kawalan Pergerakan*.
- Karim, L. A. A. (2020, April 16). PKP: e-Pembelajaran tidak segerak sesuai di luar bandar, pedalaman. *Berita Harian*.
<https://www.bharian.com.my/berita/nasional/2020/04/677952/pkp-e-pembelajaran-tidak-segerak-sesuai-di-luar-bandar-pedalaman>
- PEMANDU. (2014). ETP 2013 Annual Report — Pemandu. Retrieved 15 March, 2015, from http://etp.pemandu.gov.my/annualreport2013/upload/ENG/11_NKE09_ENG_CCI.pdf
- Shamsuddin, H. (n.d.). Integrating ICT In Teaching And Learning: Country Report: Malaysia. 1–18. Retrieved from http://woulibrary.wou.edu.my/weko/eed502/Shamsuddin_ICT_in_Malaysia_Education.pdf

DEVELOPING WEBSITE FOR TEACHING DIGITAL TOOLS IN ARCHITECTURE AND CREATIVE TECHNOLOGY PROGRAMS

Nuzul Haqimi Muhammad

Universiti Malaysia Kelantan, Bachok, Kelantan, Malaysia
nuzulhaqimi@umk.edu.my

Azlin Sharina Abdul Latef, Noorul Huda Mohd Razali, Hana Yazmeen Hapiz, Yuhanis Ibrahim

Universiti Malaysia Kelantan, Bachok, Kelantan, Malaysia
azlinsharina@umk.edu.my, noorulhuda@umk.edu.my, hana@umk.edu.my, yuhanisibrahim@umk.edu.my

Highlights: This study would discuss the development of a website used to teach digital tools for architecture and creative technology programs. The websites that had been developed would allow lecturers to manage student learning progress and assignment submissions in a single unified database to focus on giving the best feedback to the students.

Keywords: *web application in education, online learning, website development, teaching materials, database in teaching and learning*

Introduction

Online learning has become the primary means for teaching during the Covid-19 pandemic. Lecturers are forced to use web-based technologies to prepare materials and communicating with students in their respective courses. Tools such as Learning Management System (LMS) and authoring are used tremendously in various university courses to manage and prepare the teaching and learning activities (Abdulrahman et al., 2020). This study will explore the use of websites and web-based technologies in enhancing the experience of teaching and learning activities in the context of digital tools for architecture and creative technology programs. We want to highlight the method used in designing the system needed and any consideration we need to use to achieve the objective and goals of teaching and learning activities. We also outline the web tools that can be used and how they can be integrated with the developed website (Cook & Dupras, 2004). Findings from the website's usability would allow us to learn the limitation, opportunities and potential of such methodology in teaching digital tools for architecture and creative technology. Implications are discussed, and such activities' ability to enhance the student experience while learning digital tools is analysed.

Content

1. Description

The websites that had been developed would allow lecturers to manage student learning progress and assignment submissions in a single unified database to focus on giving the best feedback to the students. The website also would allow faster sharing of teaching materials to the students, especially lecture notes and software tutorials (Schindler et al., 2017). The main requirement for the website are:

- To provide teaching materials and customised software tutorials for students.
- Provide a place for students to submit their assignment progress and final artwork.
- The progress submitted needs to be given feedback. Therefore, the website also would provide feedback pages for each progress the students submitted.

2. Background

The courses involve SGA2343 Computer-Aided Design, SGD2373 Design Communication 2 and CFT1093 Computer and Arts. These courses are heavily focused on software to create design and artworks digitally. Moreover, students need to be given feedback as soon as they submit their progress. As these courses are hands-on, the student consistently needs to get guidance from the lecturer.

3. Why are they important?

Previously a lot had been done to address the need for a proper dashboard or place for all materials in the online teaching and learning experience. However, the need for faster sharing on how to use software and other digital tools and a place to collect students' work progress and become a "one-stop centre" for all the materials makes developing this website an excellent experience in teaching and learning.

4. Advantages

- Allow faster sharing between students and lecturers
- Allow faster tracking on student progress
- Provide a unified database for all activities and course needs.

References

- Abdulrahaman, M. D., Faruk, N., Oloyede, A. A., Surajudeen-Bakinde, N. T., Olawoyin, L. A., Mejabi, O. V., Imam-Fulani, Y. O., Fahm, A. O., & Azeez, A. L. (2020). Multimedia Tools In The Teaching And Learning Processes: A Systematic Review. *Heliyon*, 6(11), E05312. <https://doi.org/10.1016/j.heliyon.2020.E05312>
- Cook, D. A., & Dupras, D. M. (2004). A Practical Guide To Developing Effective Web-Based Learning. *Journal Of General Internal Medicine*, 19(6), 698–707. <https://doi.org/10.1111/j.1525-1497.2004.30029.x>
- Schindler, L.A., Burkholder, G.J., Morad, O.A. _Et Al._ Computer-Based Technology And Student Engagement: A Critical Review Of The Literature. *Int J Educ Technol High Educ* 14, 25 (2017). <https://doi.org/10.1186/s41239-017-0063-0>

PERFORMING VISUAL INTERPRETATION AND ANALYSIS IN VIRTUAL SERIAL VISION (VSV) USINGSATELLITE IMAGERY AS NAVIGATION TOOLS

Nor Hamizah Abdul Hamid

Faculty of Architecture and Ekistics, Universiti Malaysia Kelantan, Kelantan, Malaysia
norhamizah@umk.edu.my¹

Muhamad Ezran Zainal Abdullah¹, Nurul Izzati Othmani¹, Syahidah Amni Mohamed¹, Ramly Hassan², Wan Azlina Wan Ismail², Wan Saiful Nizam Wan Mohamad², Noorliyana Ramlee², Nurfadilah Saadul Kurzi², Yeo Lee Bak², Mohd Azri Mohd Jain Noordin², Ruwaidah Borhan³

¹Faculty of Creative Technology and Heritage, Universiti Malaysia Kelantan, Kelantan, Malaysia

²Faculty of Architecture and Ekistics, Universiti Malaysia Kelantan, Kelantan, Malaysia

³Faculty of Architecture, Planning and Surveying, Universiti Teknologi Mara, Perak, Malaysia

ezran@umk.edu.my, izzati.o@umk.edu.my, amni.m@umk.edu.my, ramly.h@umk.edu.my,
azlina@umk.edu.my, saifulnizam@umk.edu.my, liyana.r@umk.edu.my, nurfadilah.sk@umk.edu.my,
yeoleebak@umk.edu.my, azri.mjn@umk.edu.my, aidah866@uitm.edu.my

Highlights: This study aims to improve students' learning experience by integrating satellite imagery as navigation tools in the Urban Planning Theory module using satellite imagery. This module guided by the Design Thinking Theory, the visual interpretation and analysis are based on the five-structure set which is empathise, define, ideate, prototype and test. The result shown the significant increase after students applied the navigation technique in performing visual interpretation and analysis. Although this module focused on the design course, insights from this research may be relevant to many teaching practices and pedagogical approach in higher education and professional practitioner to support urban visualisation and design.

Key words: *Virtual Navigation, Virtual Serial Vision, Online Learning, Design Thinking Theory*

Introduction

For the past several years, the delivery of serial vision is mainly using traditional methods based on 'The Concise Townscape' (Cullen, 1971). He presented elements of townscape as an 'Environment Game' through the concerning optic (Serial Vision), concerning place (Here and There) and concerning content (This and That). This study explores the connection between serial vision and virtual navigation, leading to better urban visualisation and design. In the Sheffield Urban Contextual Databank (SUCod) project, Peng, Chang, Blundell and Lawson (2002) and Peng (2003) developed a Web-based virtual city platform to produce a new kind of virtual city application that allows end-users to reconstruct urban contexts online. Asanowicz (2011) integrates digital technology with urban composition teaching in serial vision. Recently, with the digital era taking over, it is important to include digital and online tools into the Urban Planning Theory (UPT) module. Students rely on smart devices and internet more than on conventional learning methods. Hence, the application of virtual navigation tools has been introduced in Serial Vision project to continue with this trend to better understand students and their needs. This paper urges for an integration of virtual navigation developed from the work of Gordon Cullen. Therefore, this paper aims to enhance the student's learning experience by integrating virtual navigation tool in visual interpretation and urban analysis using satellite imagery.

Advantages of the Virtual Navigation Tool in Performing Visual Interpretation and Analysis

A simple survey was disseminated on 47 students that were completed the UPT module to assess the usefulness and applicability of virtual navigation tools used in Virtual Serial Vision (VSV) project. This can also help in providing on the advantages of the UPT module. As illustrated in Table 1, there were seven (7) items using 5-point Likert scale (strongly disagree, disagree, neutral, agree and strongly agree). Overall, almost all students (87.2%) agreed that the UPT module provided several advantages than the conventional approach especially with the application of virtual navigation to present an illustration in VSV project. The application of virtual navigation tools that have been used make more than half of the respondents improved better understanding of course and project respectively (74.4% and 80.9%). The results of the simulation indicate that about 76.6% from the respondents generally agreed that the VSV project improved learning experience when it involves the usage of the virtual navigation such as Google Earth, Google Map and Google Street View as the learning tools. The UPT module inspired students to be resourceful in innovative learning with technology. With the virtual navigation tool, students thrive in hands-on learning environment and had improved drawing and design visualisation (74.9%). Furthermore, the result can be defined as considerably high especially on the time efficiency and speed since students may not have to continuously doing the virtual navigation unlike conventional serial vision, the self-navigation can be pause when needed which get around 72.4%. The virtual navigation allows students to be self-directed and flexible to work within their timeline and location without the need to travel. The fun elements that appear while using the virtual navigation is that it can increase students' learning motivation (72.4%) especially in online learning and improved students' ability to foster spatial thinking through Satellite Imagery. Solem and Gersmehl (2005) have demonstrated that online resources have helped improve student comprehension of significant concepts and skills while helping students gain confidence in their knowledge of geographical issues. Monet and Greene (2012) also support the use of Google Earth and Satellite Imagery to foster place-based teaching due to the students' difficulties in interpreting the geologic processes that shape the local and regional natural environment characteristics.

Table 1: Results on usefulness and applicability of virtual navigation in Urban Planning Theory module

Item	Scale				
	Strongly Disagree	Disagree	Neutral	Agree	Strongly Agree
Effective to present an illustration	0% (0)	0% (0)	12.8% (6)	46.8% (22)	40.4% (19)
Enhanced better understanding of course	6.4% (3)	6.4% (3)	12.8% (6)	55.3% (26)	19.1% (9)
Improved understanding of project	6.4% (3)	4.3% (2)	8.5% (4)	66.0% (31)	14.9% (7)
Improved learning experience	6.4% (3)	6.4% (3)	10.6% (5)	53.2% (25)	23.4% (11)
Improved drawing and design visualisation	8.5% (4)	4.3% (2)	12.8% (6)	60.0% (28)	14.9% (7)
Improved time efficiency and speed	10.6% (5)	2.3% (1)	14.9% (7)	49.0% (23)	23.4% (11)
Increased learning motivation	8.5% (4)	6.4% (3)	12.8% (6)	51.1% (24)	21.3% (10)

The Design Thinking Theory of the Urban Planning Theory Module in Virtual Serial Vision Project

The design process of innovation in UPT module based on VSV project encompasses five stages of Design Thinking Theory: Empathise, Define, Ideate, Prototype and Test. The first stage of the Design Thinking process was to understand the students' perspective by identifying and addressing the problem. For example, not all the group members live in the same case study compound. Hence, some cannot participate in going to the site and cannot produce manual sketches of serial vision. The second stage was to define the problem statement clearly. The brainstorming session was conducted in the meeting of the project brief attended by lecturers in the Landscape Architecture Department. Brainstorming members brought different approaches to comprehend problems and yet provide various ideas of consideration. Next, the ideation stage was composed of two steps which were idea generation and concept development. Researchers used the KJ method for idea generation. The output from the KJ method was used as a starting point for the concept development step involved the clustering, combining, and selecting of the ideas generated and then further developed the selected ones. During the prototype phase, 47 students from 10 groups were engaged in the VSV project using the Satellite Imagery as a navigation tool. The implementation of the UPT module will be upgraded based on the current advancement of technology and the users' feedback throughout the testing phase. In the testing phase, the UPT module was built based on three pillars: assumptions using a storyboard as a planning tool, prototyping where the critique session happens with the lecturer to control the potential impact of the experiment, and running the experiments through recorded video.

Commercial Value of the Virtual Navigation Tool in Urban Planning Theory Module

The UPT module reveals the prospects of virtual navigation as an enhancement tool in urban analysis and design process. The targeted groups for UPT module are Landscape Architecture and Urban Design undergraduate students. Although focused on the design courses, insights from this research may be relevant to many teaching practices and pedagogical approaches in higher education. Most importantly, it is also can be employed by the professional Landscape Architect or Urban Designers who are really interested to use virtual navigation for urban visualisation and design. Thus, UPT module has a very high potential to be employed especially by other higher learning institutions and landscape architectural firm based on the collaborated experts' recognition that VSV project received from institutions and industry.

Acknowledgement

We are grateful to all students who registered in Urban Planning Theory Course whose names are not mentioned here for their voluntarism and willingness to contribute valuable input and precious time towards this module. Without their support, this teaching innovation would not be successful.

References

- Asanowicz, A. (2011). Digital "serial vision"-new approach in urban composition teaching. Proceedings of the 29th eCAADe. University of Ljubljana (Slovenia), 21-24 September 2011, pp. 716-724.
- Cullen, G. (1971). *The Concise Townscape*. London: The Architectural Press
- Monet, J., & Greene, T. (2012). Using Google Earth and satellite imagery to foster place-based teaching in an introductory physical geology course. *Journal of Geoscience Education*, 60(1), 10-20.
- Peng, C. (2003). Serial vision revisited: Prospects of virtual city supported urban analysis and design. Proceedings of the 10th International Conference on Computer Aided Architectural Design Futures. Tainan (Taiwan), 13-15 October 2003, pp. 259-270
- Peng, C., Chang, D. C., Jones, P. B., & Lawson, B. (2002). Exploring urban history and space online: design of the virtual Sheffield application. *Design Studies*, 23(5), 437-453.
- Solem, M., & Gersmehl, P. (2005). Online global geography modules enhance undergraduate learning. *AAG Newsletter*, 40(8), 11

THE ENGAGEMENT OF CLASSIC INTERACTIVE DOLLS IN ESL ONLINE CLASS FOR PdPR

Amaal Fadhlini Mohamed

Faculty of Language Studies and Human Development, Universiti Malaysia Kelantan
fadhlini@umk.edu.my

Nazatul Syima Mohd Nasir, Ariezal Afzan Hassan, Wan Suzanna Aafanii Adeeba Wan Hassan

Faculty of Language Studies and Human Development, Universiti Malaysia Kelantan
Syima.mn@umk.edu.my, ariezal@umk.edu.my, suzanna@umk.edu.my

Highlights: Classroom games and fun activities are necessary in teaching English as a second language (ESL). Regardless of age and language setting, exceptional activities will uplift a lesson and ensure that students will leave the classroom wanting more. This project is to propose an additional activity involving interactive dolls as unique way to assist primary school students in an ESL lesson during their home-based teaching and learning method (PdPR) lesson. Using WH-questions as a guideline for learners to complete any task, this activity is called '**Ninidoll Task for PdPR**' which is conducted during the PdPR lesson. This PdPR term becomes famous as it has been introduced nationwide when the country is still fighting the massive challenges during COVID-19 pandemic. All schools are practising home-based teaching and learning method (PdPR) throughout the pandemic. This activity can be one of the additional classroom activities for ESL subject, to gain more involvement and interest toward English language learning.

Key words: *Ninidoll Task, English as a Second Language, Language Games.*

Introduction

Supporting activities and additional games are important in classrooms especially in the area of teaching English as a second language (ESL). For very young ESL learners in early childhood education, teachers usually use toys as exciting tools to use in ESL classrooms including puppets, stuffed animals and rag dolls. No matter which toys the teachers use, they are a great way to motivate the young learners to speak by asking them to describe those toys. While many might think of these toys as a subject that only kindergarten ESL learners would be interested in, slightly older learners at primary level education similarly enjoy the engagement of toys in their ESL classrooms. Moreover, toys are also relevant to assist language instructors in ESL classrooms in primary schools especially for elementary learners with low proficiency in English language. This innovative idea is to introduce an activity involving interactive dolls as unique way to assist primary school students in an ESL online lesson. Using WH-questions as a guideline for learners to complete any task, this activity is called '**Ninidoll Task for PdPR**' which is conducted during the lesson whenever it turns dull and less engaging. It is suggested to be one of the additional classroom activities to gain more involvement and interest toward English language learning.

Content

This innovative teaching idea (Ninidoll Task for PdPR) is integrating toyification into language teaching to make learning English stimulating and fun. Language learners can develop their listening, speaking, reading and writing skills through guided unique activities, even if it is conducted online through videocalls, online meetings and many other live online platforms.

Ninidoll Task for PdPR Module has commercial value, potentially for schools, language institutions and tuition centers. Teaching a group of low to elementary level of proficiency students is challenging. They lose their interest quite often during a lesson. So should things get a little dull and out of control, the proposed activity (Ninidoll Task for PdPR) will be able to pull back the attention of the class.

The general instructions in conducting Ninidoll Task for PdPR are divided into two main parts which are PART A and PART B. The instructor must finish PART A in order to continue the lesson with PART B. The instructions in PART A are as follows:

PART A (General instruction given by a language instructor for online class)

(The language instructor will 'bring' one specific interactive doll into an online lesson. The doll has its own function. The students have to choose its specific accessories. The instructor will show a few options of the accessories. Then, the students will figure out its functions based on what they understand as the doll speaks. The instructor will test the accessories based on what the students choose accordingly. The doll will respond to the right accessories. It will talk and show movements. It is like a 'try and error' game, until the students find the most suitable accessories for the doll).

The above activity is originally adapted from another Ninidoll Task module which is called Ninidoll Task 1. This task is made for face-to-face lesson, especially in a classroom. Below are the instructions in Ninidoll Task 1.

General instruction given by a language instructor for face-to-face class

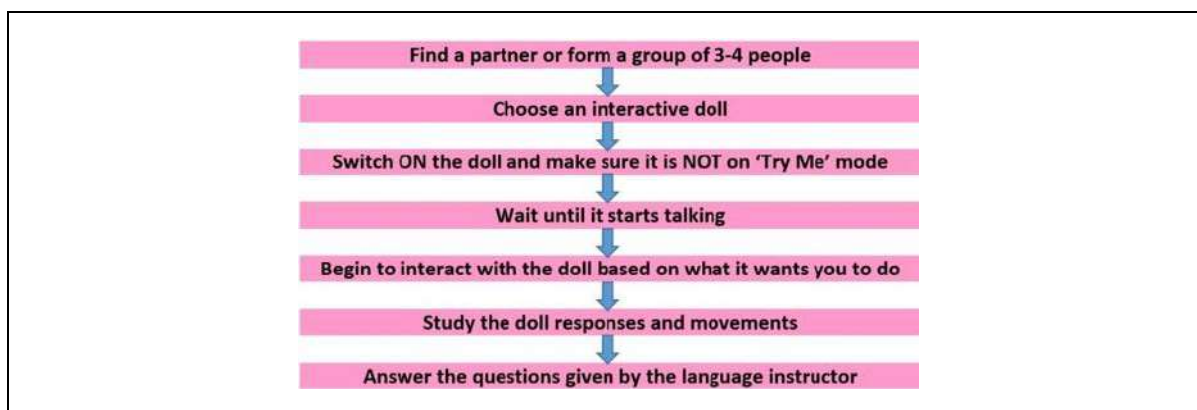

The detailed module in Ninidoll Task 1 is also relevant to be integrated in the new Ninidoll Task for PdPR. Although the students cannot physically touch the dolls like they are supposed to do in Ninidoll Task 1, the idea is quite similar. However, for online lesson, the teacher or language instructor will guide the students by showing every activity on the screen. This activity seems to be equally exciting. The students will be curious and this will lead to excitement. The column below shows the module in Ninidoll Task 1. It is also adopted into the second part in Ninidoll Task for PdPR which is PART B.

PART B (Detailed instruction given by a language instructor for online class)

Ninidoll Task 1 consists of three on-going activities which are **Speaking/Listening**, **Writing** and **Reading & Grammar Revision**. The instructions in Ninidoll Task 1 are uniquely designed to suit the functions of the interactive dolls involved (Baby Alive dolls).



Speaking/Listening

(10 minutes discussion, 10 minutes preparation, 10 minutes presentation)

- Explain the doll's features and characteristics.
- Based on your imagination, describe the doll using as many WH-questions (how, why, what, when and who) as you like.

Example:

What is the doll's name? Give one name to suit its personality.

What are the adjectives to describe the doll?

How many phrases does the doll say?

- Present your ideas to the class.

Writing

(10 minutes discussion, 10 minutes preparation, 10 minutes presentation)

- Discuss a story related to this doll. Present the brainstorm draft to the class.
- The instructor will give comments and suggestions during the presentation.
- Homework: Each pair/group has to write a narrative essay (150-250 words) based on the brainstorm draft. Give a perfect title for the essay.

Reading & Grammar Revision

(10 minutes discussion, 10 minutes preparation, 10 minutes presentation)

- Each pair/group gets an essay written by another pair/group.
- Discuss about it. Find grammatical errors and correct them all.
- Present your findings to the class.
- The instructor will give comments and suggestions during the presentation.

Using WH-questions shown in the above module, this activity is proposed to be one of the additional games in ESL during any of PdPR lessons. The PdPR term is well-known as it has been practised nationwide when the country is still fighting against COVID-19 especially during total lockdown. All schools are practising home-based teaching and learning method (PdPR) throughout the pandemic. This activity can be one of the additional classroom activities for ESL subject, to gain more involvement and interest toward English language online learning.

This innovation is developed based on a guideline model of ludification in toyification of learning, which is mentioned by Heljakka (2014). The model is as follows:

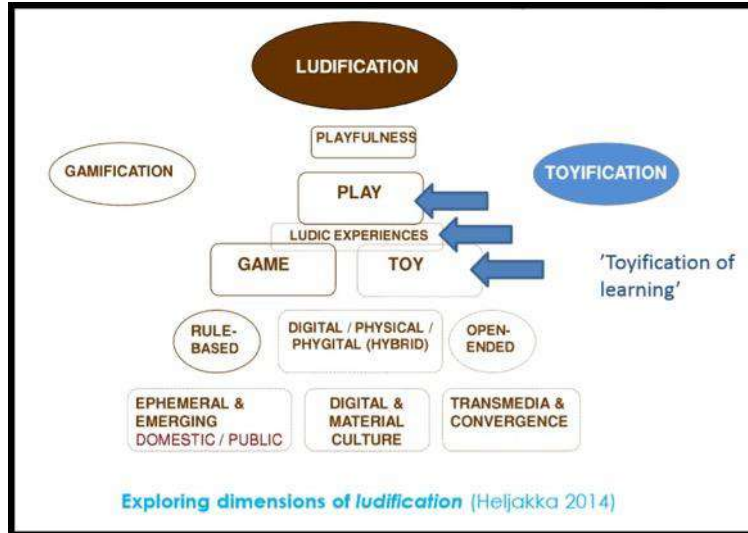

References

- Heljakka, K. (2013). Principles of adult play(fulness) in contemporary toy cultures: From wow to flow to glow. Unpublished Ph.D. thesis. School of Arts, Design, and Architecture, Aalto University, Finland.
- Heljakka, K. (2014). Playing with words and toying with vocabulary: Seizing new meanings related to the things for play, 7th ITRA Worlds Congress: Toys as language and Communication, Book of Abstract, 23-24 July 2014, Faculty of Philosophy, Catholic University of Portugal, Braga.

AN INNOVATION OF AUTOMATIC SOLAR TRACKER USING ARDUINO

Salwati Binti Mohamed@Awang
Politeknik Kota Bharu, Ketereh, Malaysia
salwati@pkb.edu.my

Nik Nor hishamuddin Bin Nik Mustapha, Ahmad Baihaqi Bin Mohd Hatim
Politeknik Kota Bharu, Ketereh, Malaysia
hishamuddin@pkb.edu.my, baihaqiahmad2109@gmail.com

Highlights: This innovation project is implemented to provide facilities for students to learn the basics of solar energy and the function of solar panels to generate electricity as well as the use of several sensors. The Arduino Mega 2560 microcontroller board is used in projects as input and output. This types of arduino was chosen because it can perform a variety of functions. This innovation project can also be used as a teaching aid in the lecture room.

Key words: *Solar energy, solar panel, sensor, Arduino Mega, teaching aid.*

Introduction

Solar energy is one of the sources of energy to produce electricity. Solar energy is categorized as renewable and easily generated energy using solar panels built from Photovoltaic cells to absorb sunlight. In Malaysia the use of solar energy is increasing and received an encouraging reception. The condition of covid 19 is now a higher electricity use due to many who are at home. This has had an effect on increasing electricity bills every month. The use of solar energy gives many advantages to consumers including being able to save electricity use every month, it does not pollute the environment, maintenance is easy, does not produce the effects of greenhouse gases and so on.

Knowledge of the use of solar energy to students of the Department of Electrical Engineering in Polytechnics through the use of Solar Trainer in the laboratory. With this equipment students can understand the use of solar panels as a tool to absorb solar energy and generate electricity. Through the experiments, students were able to read the voltage and current value generated and see motors, lights and fans functioning. However, the learning of the students is only focused in the laboratory because the equipment is too large and the light is used as a sunlight. This problem gave an idea to produce Automatic Solar Trackers Using Arduino to make it easier for students to understand the use of solar energy as a source to generate electricity.

Hopefully this project will give benefit to all students especially those taking Power System and Renewable Energy courses in Polytechnic. This project is a good innovation idea and can make improvements in the future.

Content

1. Description of innovation.

This innovation project is designed and named as Automatic Solar Tracker Using Arduino. This idea project from advisors to carry out solar project. The project was chosen when it realized that solar energy is one of renewable energy and its resources will not be exhausted. From the experiments in the power system laboratory, the solar trainer unit was too large and difficult to bring to the lecture room. The use of light replacing sunlight in experiments generate creative ideas to produce the device absorbed energy on panel solar from sunlight. Voltage, current and temperature can also be read and recorded by students.

2. The context or background of the innovation, design and process.

This innovation project was chosen because Solar Trainer Unit in Power System laboratory takes 5 minutes for heat energy from lamps to be absorbed into Photovoltaic cells where heat from lamps is used to replace sunlight as a source of energy. The experiments also require cables to connect from solar panel to Solar Unit Trainer. Besides, the existing equipment in the laboratory is too large and very difficult to bring in the lecture room.

Five design thinking process are applied to produce this innovation project which starts empathize on what the problem that occurs through surveying, define that is the importance of the tool, ideate on how it solves the problem, the prototype of designing to produce tools and test that is to carry out testing of the tool is functional or not.

3. The importance of this innovation to education

This project is very important to the department and students especially those taking Power System courses. It can be applied as a tool for experimentation. In addition, this project can be used as a reference for other courses such as Renewable Energy. This project also makes it easier for lecturers to explain the use of solar panels and the use of three detectors installed on the project.

4. Advantages of innovation towards education and community.

The advantages of this project are it can save students time retrieving data and it does not require connection cable. Current and voltage readings are displayed on LCD (Liquid Crystal Display), the use of three type detectors such as LDR (Light Depend Resistor) which is used to detect light and the value will change according to light intensity. LDR are often used in electronic circuit designs where it is necessary to detect the presence or the level of light (Ian Poole, 2021). DHT11 is a detector to measure the temperature level of the environment and humidity of the surrounding area. On the other hand, the Photodiode detector light-sensitive normally used on the solar tracker to provide the amount of sunlight data received by the solar panel. Besides that, the solar panel can be rotated 360 degrees and referring to the sunlight location. The Figure 1 shows the labels part of the components or equipment used in the innovation project.

In teaching and learning process, we are hoping students can understand the usage of solar panels as well as the use of sensors that are installed.

The prototype is also portable, easy to take to lecture rooms and can be used as a teaching aid. The development of this project uses hardware and software such as Arduino software to insert the encoder data on the Microcontroller Board, Arduino Mega 2560 to move each detector and solar panel either clockwise or counter clockwise and also can be controlled using a smartphone. Some of the other hardware used are DC Motor, Motor Driver, Solar Controller, Switch and some electronic components.

5. Commercial value in profitability of innovation.

The project has the commercial values and can also be used for other courses such as Renewable Energy courses as teaching aids. This project was carried out under the sun and the project has functioned well and able to achieve its objectives. The results of this project were able to function successfully and the students were able to understand the usage of solar panel clearly. As a suggestion in the future, the project needs to be made further improvements to strengthen its functions.

References

- Allessandra, A. J., O'Connor, M. J., & Van Dyke, J. (1994). *People Smarts: Bending the Golden Rule to Give Others what They Want*. Pfeiffer. <https://economictimes.indiatimes.com/definition/solar-panelAlessandra>
- Elprocus (2021) DHT11 Sensor and Its Working <https://www.elprocus.com/a-brief-on-dht11-sensor/>
- Ian Poole (2021) Light Dependent Resistor LDR: Photoresistor. https://www.electronics-notes.com/articles/electronic_components/resistors/light-dependent-resistor-ldr.php

SRAV TRAINER KIT

Syed Arifin Bin Engku Sulong

Politeknik Sultan Mizan Zainal Abidin, Dungun Terengganu, Malaysia
sy.arifin77@gmail.com

Nor Juliha Binti Said, Roslinda Binti Sidek

Politeknik Sultan Mizan Zainal Abidin, Dungun Terengganu, Malaysia
jue2306@gmail.com, roslinda@psmza.edu.my

Highlights: SRAV Trainer KIT was developed to overcome problems faced when implementing laboratory work process for Semiconductor Devices course in polytechnics. Among the problems encountered was difficulty connecting circuits, limited time and insufficient number of trainers. SRAV Trainer KIT only uses a simple circuit without any components and is used for a specific practical work only. The cost of producing SRAV Trainer KIT is low due to the DIY concept. The conclusion of SRAV Trainer KIT can help students implement practical practices for Semiconductor Devices course in a more practical and optimal manner.

Key words: *Trainer, Semiconductor, Electronic circuit, Practical work*

Introduction

Learning that uses models as teaching aids can be used to encourage students to learn some learning techniques more effectively (T. C. S. Potter et al., 2017). Electronic trainer board became a popular tool widely used in teaching and learning methods (K. & B. Ajao, 2014).

This SRAV Trainer KIT can help students understand the basic concept of electronic circuit handling and ultimately master the field. This is because learning media using KIT trainers can be used in the learning process to increase the desire and interest in learning, arousing motivation and stimulation of learning activities can even influence the psychology of students (A. Kurniawati, 2017).

Taking this approach, the SRAV Trainer KIT was built specifically for use in the Semiconductor Devices course at PSMZA. If an institution desires to use Trainer in the correct ratio, it will involve the use of high costs, limited number of students and also restraint on time in laboratory learning/testing (M. M. Asad. et al., 2014; D. Ibrahim, 2003; S. Siagian, 2014).

Content

Most of these Trainers will be provided with multiple circuits for several different shifts on one module. Among the problems faced by students in carrying out the work of practice using existing trainers are students have difficulty identifying circuit positions with regard to the practical that need to be implemented, the position of the components in the Trainer does not conform to the practical layout implemented and there is damage to the component and causes the Trainer to be unusable. Taking into account the problems mentioned above, the SRAV Trainer KIT was developed to solve the problem. The selection of the word 'SRAV' means

- S: Simple – Developing an easy-to-understand and adoptable Trainer
- R: Reliable – Reliability of results from its use is high
- A: Acceptable – Acceptance of this Trainer when the result is correct
- V: Valuable – Valuable to students when SRA is achieved

The circuit production process is made using the appropriate *PC Maker*. While this process is being implemented, several factors should be taken into account, among which are circuit type, components to be used and circuit usability by students. This factor is important because each final circuit to be produced must be at a high level of reliability. If viewed from the existing type of Trainer, before conducting the experiment, students should ensure some things first, among them are identify which circuits to use, which connections to make and selection of the correct point during the experiment. With the SRVA Trainer KIT built, students only have to think about their products or test results without the hassle of choosing a circuit or making the right connection. The end result of the circuit connection on the printed board is as Figure 1,

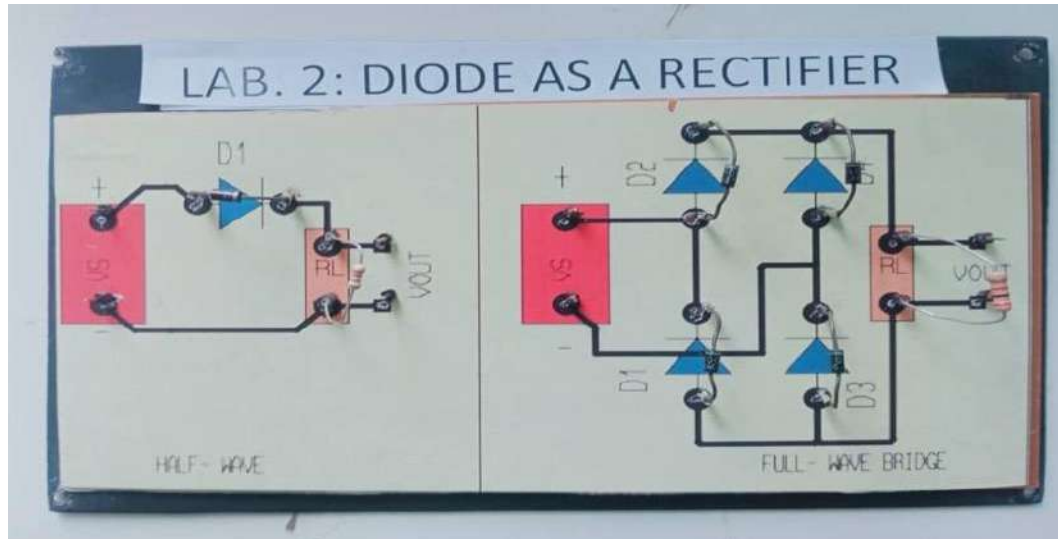

Figure 1: circuit connection on the printed board

Advantage of SRVA Trainer KIT is easy to use, user friendly, save time on laboratory use and cheap to produce. Therefore, with the stated advantages, the SRVA Trainer KIT is able to meet the requirements and suitability to carry out practical work for Semiconductor Devices courses in polytechnics.

References

- Kurniawati, A. (2017). Pengembangan Trainer Digital Mata Pelajaran Dasar Dan Pengukuran Listrik. *Jurnal Pendidik. Tek. Elektro*, vol. 7, no. 4.
- Ibrahim, D. (2003). Teaching digital control using a low-cost microcontroller-based temperature control kit. *Int. J. Electr. Eng. Educ.* 40(3), 175–187.
- Ajao K. & B. (2014). Local Fabrication of Digital Logic Trainer for Laboratory Demonstration. *International Journal Of Innovation In Science And Mathematics*, 2(1), 143–46.
- M. M. Asad, D. R. Bin Hassan & F. Sherwani. (2014). Design and Development of A PIC Microcontroller Based Embedded System Trainer Panel for Electrical Personnel Training, 12(8), 1–11.
- Siagian, S. (2014). Development of Basic Electronic Instructional Module And Trainer Sahat Siagian Panahatan, Jongga Manullang. State University of Medan. *Eur. J. Comput. Sci. Inf. Technol.* 2. 2(3), 36–46.
- T. C. S. Potter, N. V. Bryce, and C. A. Hartley. (Jun 2017). Cognitive components underpinning the development of model-based learning. *Dev. Cogn. Neurosci.*, vol. 25, pp. 272–280.

SMART SPRING ABSORBER REPLACEMENT [SSAR-01]

Mohd Azri bin Abdul Ghani

Mechanical Engineering Department, Polytechnic Kota Bharu, 16450 Ketereh, Kelantan
mohdazrikp2gw@gmail.com

Muhd Naqib Bin Mohd Rezali, Muhd Irfan Akif Bin Mohd Radzi, Muhd Syafiq Bin Mohd Afandi

Mechanical Engineering Department, Polytechnic Kota Bharu, 16450 Ketereh, Kelantan

Highlights: This Smart Spring Absorber Replacement will focus on the improvement of the existing spring absorber converter to the innovative spring absorber converter and it is easier to use especially for mechanics, This tool works to change the absorber or spring absorber on certain vehicles because it has a limit for the size of the absorber spring which is too large.

Key Words: *Development, Design, Integration, security, savings, innovation*

Introduction

This Smart Spring Absorber Replacement will focus on the improvement of the existing spring absorber converter to the innovative spring absorber converter and it is easier to use especially for mechanics, This tool works to change the absorber or spring absorber on certain vehicles because it has a limit for the size of the absorber spring which is too large.

The objective of this Smart Spring Absorber Replacement is to facilitate the work in each workshop. The creation of this Smart Spring Absorber Replacement is to upgrade the mechanical work in each workshop to the better. This Smart Spring Absorber Replacement is a method of use that also has better safety features and durability.

In addition, by producing this project is also to upgrade and improve for the work in the vehicle workshop by integrating adjustable time features for time and energy savings. This Smart Spring Absorber Replacement involves the process of welding and materials such as iron to create an innovative project.

Content

1. To save mechanical time in the process of opening and installing the absorber spring.
2. To facilitate work in maintenance.
3. To be used safely to reduce consumer risk Description of your innovation / product development / design / process.
4. Save time in the process of opening and installing the absorber spring on the car.
5. The product is more practical and simplifies the work of changing the absorber spring.
6. Ensure the satisfaction of customers who come to repair the car in the workshop (for mechanics).
7. Reduce the problems encountered during the process of opening and installing the absorber spring.

Innovation design

Innovation design is one of the data processing collected based on specific and systematic planning of the concept of formation in the study.

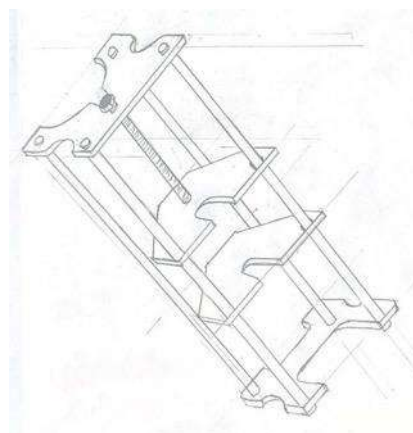

Engineering Drawing 1: Innovation project design

Conclusion

The results of the tests conducted on Smart Spring Absorber Replacement, it can be concluded that Smart Spring Absorber Replacement has achieved the objective of the study which is to determine the value of uniformly distributed load capable of pressing the spring absorber by using an air gun. In addition, it has been tested by small workshops around our residence and proved useful because it has simplified the mechanical work in the maintenance process, reduced manpower and saved time.

References

- Adhalina, N. (2011). The Different Language Style and Language Function Between Students and Teachers in Updating Their Status In Facebook Webpage (A Case Study of the Topic National Final Examination 2011)(Doctoral dissertation, University of Diponegoro).
- Alessandra, A. J., O'Connor, M. J., & Van Dyke, J. (1994). People Smarts: Bending the Golden Rule to Give Others what They Want. Pfeiffer.

DUE 10012 COURSE OVERVIEW ANIMATION VIDEO

Wan Rahayah Rahimi Wan Ramli

Politeknik Kota Bharu, Ketereh Kelantan, Malaysia
vyarahayah78@gmail.com

Highlights: This project was entirely developed by using VideoScribe whiteboard animation tools software. It was chosen due to its unique quality of presentation that combines certain elements such as text, image, sound and motion altogether in one canvas. With the infinite size of canvas, I can add all those above-mentioned elements on the canvas without limit. This education-based context project was meant to be used as a visual aid for my introductory class. The combination of certain aspects, such as informative, eye catching and fun way of learning, were among of the advantages of this project.

Key words: Videoscribe, project, elements

Introduction

This innovation project was inspired from a PPK (upskilling) course that I attended before. During the course, I found out that using videoscribe whiteboard animation software is such a fun, eye catching and enjoyable way of learning. Thus, I decided to join this carnival and showcase what I have learned and applied from that particular course.

For the purpose of this innovation project, I have chosen the course overview of DUE 10012 Communicative English 1 as my main content. This is due to the importance of imparting the first and correct impression and understanding among students, especially semester one students, who have just enrolled to the polytechnic system, regarding the requirement of the course they will undergone for that semester.

By having this exposure, the students will be able to learn accordingly and be more responsible to their own studies by following and fulfilling all the list of requirements set by the lecturer and the department.

Content

1. Description of my project.

The DUE 10012 Course Overview video was developed by using the Videoscribe whiteboard animation tools software. Almost all elements provided in the Videoscribe whiteboard animation tools, such as **text, image, chart, sound and motion** were used in this 2.15 minute - duration video. For the first element which is 'text', I just stick to only one type of font text, that is **Londrina solid** and didn't use any type of alignment setting, in order to maintain the consistency of the project design. However, I did change some of the text colours to suit with the background canvas or the chosen images.

For the 'image' element, I have retrieved the selected images from 3 different sources available in the videoscribe which are, videoscribe library, from my own gallery (personal computer, hand phone, etc.), and also from the online website (by using the 'url' link). Other than normal images, I have also used four different **gif** images, which were retrieved from the videoscribe library. In order to enhance the presentation, those gif images were set to 'play continuously' throughout the video.

The next element is 'chart'. There are 3 different types of charts provided, which are bar, line and pie chart. But, in this project, I chose only a pie chart, which is the most suitable type of chart to represent the break up percentage of assessments of this course.

For the fourth element which is 'sound', I have used the available soundtrack from folk/easy genre list, which is 'chestnut line' as a background music. This background music sparked the mood of a happy learning session. I have also recorded my own voice as the voice over to present the whole content of the video. The process of recording the voice over was actually the first step done in this video making project before inserting those other elements.

The last element which is 'motion', was being used for the entire video and mostly incorporated with the first three elements mentioned above (text, image, chart). All elements of animation including 'draw', 'move in', 'fade in' and 'morph' were alternately being used throughout the video. Some advanced animations for instance, the 'erasing effect' animation was also being applied. Those selected texts, images and chart were arranged according to the designated scene and were adjusted accordingly at the 'timeline'. Camera position plays an important role here in ensuring the zoom in and zoom out process runs smoothly. Likewise, the adjustment setting for 'animate', 'pause' and 'transition' time for each scene must be paralleled or synchronized with the voice over.

Other than that, some graphic filters such as 'glow', 'drop shadow', inner shadow' and 'bevel' were also being applied for certain elements, most exactly for the images.

2. Context or background of the project

The background of this project was based on **education context**, focusing on **giving initial information** prior to the development of the content of specific learning session. Consists of **important information regarding the course** such as the Course Learning Outcome (CLO), Course Content (topics) as well as the Course Assessments and overall marks from each assessment.

3. The importance of this project

This project was meant to be used as an **impressive 'set induction'** for the first lesson meeting with the new students who registered for the DUE 10012 course. Thus, it is significant to **project a clear outline** of the course content, course assessments and also the **medium of getting further information** regarding the mentioned course. This will automatically **direct the students' goals** towards achieving better grades and performances by fulfilling all the requirements needed and hence be more **responsible** for their own studies. This kind of invention can also blow the spirit of producing a good and attractive visual aids for the teaching and learning process especially for the e-learning purposes.

4. Advantages of this project towards education and community.

Other than being an **informative** animation video, this project was also an **eye catching**/a kind of audience's attention grabber, **fun**/capable of avoiding dull and boring session from the very beginning, and allow students to be more **focus**, interested, and always motivated to **engage** in the next session. It is **reusable** and specifically designed for Communicative English 1 course. Therefore, it also can be used by other lecturers who teach the same course.

5. Commercial value in terms of marketability or profitability of the project.

This project has successfully gained a **good feedback** from my students, friends and relatives as I uploaded in the YouTube and shared the link with them in my social media platforms. Many of them were **interested** with this project and **wish to learn** the process of making this whiteboard animation video. Hopefully, one fine day I can arrange a **sharing session** or conduct **in-house training** for them.

Not only colleagues, other lecturers from other polytechnics all around Malaysia (who teach the same course) can also get benefit from this project once I publicly upload it on YouTube channel.

In future, I am planning to collaborate with other lecturers who have the same passion, motivation and mission to produce a more comprehensive and high quality of video animation project that will not only beneficial for the students, but in such a way, it also can gain some commercial value when it is launched on YouTube channel and get many viewers or subscribers.

Acknowledgement

I am so grateful to Pn Siti Suhaidah Sahab, the instructor of the PPK (upskilling) course from the Faculty of Architecture, Planning & Surveying, UITM Shah Alam, for introducing me to this wonderful software and has successfully guided me on using this amazing tool. Her most outstanding notes and tutorial videos shared on her padlet link has also benefitted me a lot throughout making this project a successful one.

References

Wan Rahayah Rahimi, W.R., Noor Asmaa', H., Kamilah, Z., Che Fadhillah, C. L., Khor, M. S.C, W. Farhana, W.H., Marianti, M.S., Nik Nur Fathiha, N.D., (2019). DUE 10012 Communicative English 1 Module, (3rd Edition), English Unit, General Studies Department, Politeknik Kota Bharu.

PORTABLE PROGRAMMABLE LOGIC CONTROLLER TRAINER WITH MODULES FOR TRAINING

Nurul Aemyza Binti Che Fauzi

Polytechnic Kota Bharu, Ketereh, Malaysia
nuraemyzaf01@gmail.com

**Roslinda binti Ismail, Nurul Fatini Bt Abdul Pattah, Mohamad Adli Bin Mohamed Nor, Mphd Adli Bin Zaki,
Mohd Hafiq Bin Che Sayufi**

Polytechnic Kota Bharu, Ketereh, Malaysia
roslindaismail78@gmail.com, nurulfatini2612@gmail.com, stylonir22@gmail.com, Muhdadliooo88@gmail.com,
erapremium8892@gmail.com

Highlights: Programmable logic controller (PLC) is a microprocessor -based control system designed to operate in the industrial sector for control purposes. The PLC can be programmed to detect, move and control industrial equipment such as motor operation, lights, solenoids, hydraulic systems and more by the operator in industry. PLCs are generally illustrated with lines and equipment on a ladder diagram. Through a computer program various inputs can be identified and the results of this information are made to produce the outputs needed to control the system. These components work together to bring information into the PLC. Without any key components, the PLC will fail to function properly. A PLC trainer is a programmable logic controller training system that contains specialized programming software to make logic workable. PLC trainers are important for students in technical schools, community colleges, Malaysian polytechnics and universities who are starting to learn PLC programming. With this PLC trainer, practice simulations can be generated such as timer programming operation, counter programming operation, basic instruction programming, combination instruction programming, traffic light application and so on. A project to build a PLC trainer will be made by semester 4 students of the December 2020 session at Polytechnic Kota Bharu who take the PLC & Automation course (DEJ 40033). The project will be built using the OMRON SYSMAC CPlE model PLC. This project will make it easier for students to understand the wiring connections on the PLC. With this PLC trainer as well, students can do simulations in the form of hardwired model. Furthermore, this trainer is suitable for the students to develop competence in operating, programming and troubleshooting plc control circuit.

Key words: *programmable logic controller, input, output, ladder diagram, trainer, hard wired*

Introduction

The PLC(Programmable Logic Controller) and Automation is a compulsory course taken by students of the Department of Electrical Engineering in fourth semester studying at the Malaysian polytechnic. A new Trainer PLC Trainer has been designed to help students understand the theory and practice of the programming course in one complete trainer package. Learning programming logic controller for electrical engineering students is something that is difficult to understand because the operation of the program cannot be seen like other courses. This PLC Trainer is apply the Design Thinking Model method, involves in 5 process which is Empathize, Define, Ideate, Prototype and Test. The innovation of PLC Trainer involves two new inventions, namely practical modules and learning modules that innovate in packages. This creative trainer involving various type of inputs and outputs to produce a variety set of controlled by the program. The materials used are durable and easy to use, consisting of a package of control modules, inputs, outputs, program tools, module notes and a trainer box. The result is a trainer tool for complete programming and it can also increase students understanding of the concept of programming and control, further increasing the interest of students to study this course.

Content

Novelty

This Mobile PLC Trainer offers a platform that enables students to perform a comprehensive range of programming tasks culminating in the control of the unit using an industrial programmable logic controller (PLC). Students develop their understanding of PLC programming using our unique software (Cx Programmer) simulation of an industrial work-cell. The trainer is housed in a waterproof case for ease of transportation and shipping. Open system, ready to communicate with personal PC. Easy to program and portable. Shortage-circuit protection. The PLC Trainer is a complete training system, introducing the student to the operation, programming and troubleshooting of modern industrial programmable logic controllers. A high performance multi-purpose PLC controller (CPlE) designed for all kinds of automated equipment. The PLC Trainer learning materials have been designed to provide practical real-world problem solving tasks and activities within the classroom or lab environment. Ladder Logic Simulation Software.



Programmable Logic Controller Trainer

Descriptions

This Basic PLC Trainer is a complete training system, introducing the student to the operation, programming and troubleshooting of modern industrial programmable logic controllers. A complete curriculum is provided incorporating many learning activities related to basic sequence, circuit flow, ladder logic programming and troubleshooting. Many activities reflect realistic industrial applications. This trainer, associated student manual and programming manual, creates a complete introductory course in PLCs, for industrial training applications as well as in the educational learning.

Advantages

Facilitating users or students handle PLC Trainer anywhere for practical work purpose. Consists of a complete package of control modules, inputs, outputs, programming tools, module notes and a trainer box with hardwired system reflect to realistic industrial applications. Able to increase students' understanding of programming concepts more easily. Students can use the tool without complete assistance from the lecturer as all the notes and manuals are already available. The materials used are easy to carry anywhere and durable.

Commercialisations

This innovation project is not only suitable for use in the Department of Electrical Engineering, Kota Bharu Polytechnic but also for all Malaysian polytechnics (33 polytechnics and Malaysian Community Colleges 79 Malaysian Community Colleges). This project can also be applied in IPTA and IPTS in the field of Electrical Engineering or Mechanical Engineering. This project also has the potential to be commercialized for all educational institutions either locally or international

Acknowledgement

All praise to Allah s.w.t the Almighty, for giving us the blessing, the strength, the chance and endurance to complete this study.

References

- Mohammad Fotouhi, Ali Eydgahi, William Cavey Electrical Engineering Technology/Engineering and Aviation Sciences University of Maryland Eastern Shore Princess Anne, MD 21853 Session 1620 (2016) DESIGN OF A PROGRAMMABLE LOGIC CONTROLLER TRAINER
- Tzu-Chiang Rd., San Chung City 241, Taipei Hsien, Taiwan R.O.C. (2015) PLC TRAINER PLC-200 K&H MFG. CO., LTD. 5F, No. 8, Sec. 4 <http://www.kandh.com.tw> E-Mail: education@kandh.com.tw Fax : 886-2-2287-3066, 2287-9704 Tel : 886-2-2286-0700 (Rep.) 2286-7786
- Matthew Oluwole Arowolo , Adefemi Adeyemi Adekunle, Martins Oluwaseun Opeyemi (2016). Design and Implementation of a PLC Trainer Workstation Department of Mechatronics Engineering, Federal University Oye – Ekiti, 371 104, Nigeria
- Aaron Dickinson, Graduate Student Donald M. Johnson, Professor Department of Agricultural & Extension Education 205 Agriculture Bldg. Fayetteville, AR 72701. (2006) A Low-Cost Programmable Logic Control (PLC) Trainer for Use in a University Agricultural Electricity Course

CONDUCT OF GRADATION TEST IN DETERMINATION OF SOIL PARTICLE SIZE DISTRIBUTION USING VIDEO

Norli Binti Ismail

Politeknik Kota Bharu, Ketereh, Malaysia
norli@pkb.edu.my

Rus Ayunita Binti Jusoh

Politeknik Kota Bharu, Ketereh, Malaysia
rusayunita@pkb.edu.my

Highlights: The development of a multimedia display in the form of video in teaching and learning is normal and it is useful to assist the teaching and learning process. This video displays the implementation of laboratory experiments for practical classes to determine the size distribution of soil particles through a gradation test or sieving test. Gradation test is one of the practical assessments for the Soil Engineering course.

Key words: *video, teaching and learning, test, equipment, procedure, gradation test, particle size distribution*

Introduction

The video presentation begins with an introductory display on soil particle size, basic equipment used and procedures for testing the distribution of soil particle size through a gradation test. The content of this display also includes a brief overview of the gradation test in determining particle size, equipment used during the practical and further helps students complete the determination of particle size distribution and soil classification based on data analysis and plotting the graph of particle size distribution.

This video helps students understand the course more easily and it can be seen over again. The teaching and learning process that takes place in the classroom or online classroom is more effective. Students can also use the video to help while revision lessons.

Content

The process of developing a t&l video of a gradation test in determining the size distribution of soil particles is an alternative method that helps students to understand their learning physically or virtually. In general, multimedia uses a variety of media formats to present information (Hede T. and Hede A. 2002). This video includes the introduction of particle size, equipment used and working procedures for gradation tests in determining the particle size distribution. Students can easily classify soil types based on data analysis and plot the graph of particle size distribution. Movie Maker software used to complete the work of text editing and video editing that was recorded. The video display presentation is arranged in a neater layout so that the display is effective. This video becomes an innovation of teaching and learning by connecting the advantages of multimedia in the teaching and learning process to be more effective. According to Merriam (1998), the observing individual will be able to detect something that is routine to the subject i.e. things that can lead to an understanding of the context. The video display helps students to understand the laboratory method or procedure to perform the experiment.

Educators thought that multimedia is part of a combination of technological resources, which includes media elements such as text, graphics, animation, video, sound, teaching method and computer based support systems (Neo and Rafi, 2007). Thus, one of the purposes of developing this t&l video is as an alternative teaching method. This video helps the teaching and learning process and revision more effectively. This t&l video increased students' understanding of the introduction of gradation test or soil sieving test in determining soil particle size distribution. The method taken in developing this t&l video starts by getting information related to soil particle size, equipment used, soil gradation test and its procedure. The aid of corresponding diagrams to make it easier to understand. Video with simple information and attractive presentations by providing an easy way to understand, the role-play during conducting the experiments involves how to use appropriate experimental equipment and related procedures. Interactive learning will make students more fun for students to learn in their own way or style of learning (Tan & Leong 2003). Therefore, the slides displayed are simple but compact because they want to encourage students to follow the video easily, in a happy mood and relaxed. T&l process with this video in the teaching process becomes easier, uses quality time effectively and increases the understanding among students.

Mayer and Sims (1994) have stated that images entering the cognitive system through the eye senses are likely to be processed as visual representations in the visual-pictorial channel, while word speech, entering the cognitive system through the ears and are likely to be processed as verbal representations in the oral-auditory channel. The preparation of this video slide developed as an alternative t&l method while implementing in the teaching and learning process by face to face or virtually. Video media improves memory, increasing students' understanding and acceptance of the topics discussed. It is very important that students clearly understand the teaching information and the teaching objectives achieved. The time allotted during the t&l process used as best as possible and it is necessary to ensure that the time used in a quality manner. Simple, light and relaxed teaching materials can help students concentrate and learn in a calm and happy mood. The advantages of technology in t&l are undeniable, thus video media like this have an advantage as a choice of students while studying and reviewing lessons.

The development of this practical t&l video has a good impact, saving t&l time with limited resources while learning physically or online. It gives a positive effect and response to students' motivation, shows that students clearly

to understand the teaching with a simple method. Based on the observation and distribution of the questionnaire after the video display, it found that the learning in the classroom was more encouraging and the students were satisfied. Students responded that they understood the content of the learning and felt confident to conduct gradation test more easily. This is because they have been given basic exposure to the gradation test procedure, identified the equipment used and understood the experimental procedure more effectively. This video aid helps the t&l process and gives a clear picture of the soil gradation test determining the distribution of soil particle size.

Table 1 below shows the questionnaire responses from 50 respondents consisting students of Diploma in Mechanical Engineering (Agriculture) (DPT) Semester 4 who took the Soil Engineering course. The findings obtained from the distribution of the questionnaire found that almost all students 100% agreed (scale 4 - agree and scale 5 - strongly agree) and gave positive comments. Based on the students' observations and responses, it found that the learning process was more encouraging and the students were interested in following the video. Students find videos helpful and informative even though they are simple and easier to understand than reading books and notes. Students comments this video guiding them to complete assignments in short time because of informative displays, interesting diagrams, relaxed and effective.

Table 1: Response to a questionnaire through 50 students on the satisfaction of using t&l video of gradation test to determine the distribution of soil particle size in the learning process.

No.	Item	Scale				
		1	2	3	4	5
		No. of Student				
1.	Understanding is an important aspect of the t & l process	0	0	0	15	35
2.	The soil sieve video display helped me before running the actual soil sieve experiments in the lab	0	0	0	30	20
3.	I was able to identify all the soil sieve test equipment through the video display	0	0	0	34	16
4.	I enjoy doing the practical after understanding the procedure of making a soil sieve test first	0	0	0	27	23
5.	I was ready to do practice better after watching the soil sieve video display	0	0	0	32	18
6.	The lecturer of Soil Engineering Course gave a good explanation while watching the soil sieve video	0	0	0	29	21
7.	The video display of the soil sieve was able to pique my interest in performing real practical	0	0	0	24	26
8.	My lecturers always make sure I understand the steps of implementing a soil sieve experiment.	0	0	0	22	28
9.	One of way to help students like me understand during t & l process is to use a video display	0	0	0	23	27
10.	I was able to focus on my lesson well while watching the soil sieve video	0	0	0	31	19
11.	I think the soil sieve video is interesting and helps me a lot in the understanding of students like me.	0	0	0	27	23

The use of these multimedia elements related to the topic and according to the suitability of the course. Based on the students' observations and responses through the questionnaire, it found that the learning process was more encouraging and the students were interested in following the video. Students find videos helpful and informative even though they are simple and easier to understand than reading books and notes. Students provide comments saving reading time to complete assignments and this video is very helpful because of informative display, relevant and interesting diagrams, and plotting graphs of particle size distribution easier. Video display using this interactive video media facilitates teaching. It is one of the interactive videos and adapts the advantages of multimedia in a more effective teaching and learning process.

Application of technology is one of the requirements to produce an effective teaching and learning process. However, more important is the understanding of how new media can be used effectively to provide new ideas to present learning materials that allow students to be motivated to explore the content of the lesson which in turn enriches the learning process. Information technology is dynamic and constantly evolving rapidly. Multimedia is also an example of a technology that is going through an era of development. It is undeniable that it has great potential in the current education system. Accepting the presence of this multimedia technology is not enough without practicing it. Therefore, to take advantage of it and need to constantly follow various training and related courses to add knowledge and skills in line with the development. By using basic multimedia computers, instructors can use a variety of multimedia applications in the classroom.

References

- Hede, A. (2002). Integrated model of multimedia effects on learning. *Journal of educational multimedia and hypermedia*, 11(2), 177-191.
- Hong, T. L., & Leong, P. (2003). Professional development of ITE teachers through learning circles. *Teacher Education Institute*.
- Mayer, R. E., & Sims, V. K. (1994). For whom is a picture worth a thousand words? Extensions of a dual-coding theory of multimedia learning. *Journal of educational psychology*, 86(3), 389.
- Merriam, S. B. (1988). Case study research in education: A qualitative approach. *Jossey-Bass*.
- Neo, M., Tse-Kian, K. N., & Eshaq, A. R. M. (2007). Designing interactive multimedia curricula to enhance teaching and learning in the Malaysian classroom-from teacher-led to student-centered experiences. *International Journal of Instructional Media*, 34(1), 51-60.

JAMBOARD IN FINANCIAL MANAGEMENT: ENGAGED AND ENHANCED STUDENT'S PERFORMANCE

Ruzanifah Kosnin

Universiti Malaysia Kelantan, Kota Bharu, Malaysia
ruzanifah@umk.edu.my

Siti Salina Saidin, Suchi Hassan, Ahmad Fahme Mohd Ali, Naziatul Aziah Mohd Radzi

Universiti Malaysia Kelantan, Kota Bharu, Malaysia
salina.s@umk.edu.my; suchi.h@umk.edu.my; fahme.ma@umk.edu.my; aziah.mr@umk.edu.my

Highlights: Learning Financial Management course requires the use of a whiteboard to explain the calculation topic to engage and help students understand better. However due to the COVID-19 pandemic, traditional teaching and learning using a physical whiteboard is no longer applicable. Google Jamboard Web is one of the most effective tools for drawing and writing online that replicate physical whiteboards. It works better than the physical ones since students and lecturers can collaborate during class, while lesson materials in the jams can be shared through pdf documents. Thus, this study assesses the effectiveness of Jamboard application on Financial Management course among students of the Faculty of Hospitality, Tourism, and Wellness in University Malaysia Kelantan.

Key words: Jamboard, Financial management, Calculation, Online whiteboard, Collaborative learning, Engagement

Introduction

The spread of the COVID-19 virus forced the university to explore simple, effective alternative ways to rapidly turn the current type of face-to-face lectures into online meetings. Therefore, one of the best solutions for the force-significant scenarios using free software and services is Google Jamboard App. Jamboard is an immersive smartboard where educators and students can collaborate on a virtual whiteboard to make drawings or share ideas. Jamboard used in explaining financial calculation during tutorial using asynchronous teaching approach received positive feedback from students. Jamboard as teaching tool for Financial Management may increase student engagement and boost learning performance, thus, improve student's results, but it must be used with a clear focus on essential content.

Content

Google Jamboard functions as an interactive smartboard where lecturers and students can work together on an online whiteboard to create sketches, brainstorm ideas and answer questions. In Jamboard web application, lecturers can write, and draw using a stylus with several different colors, insert images, drag and resize text and images. Lecturers can share the jams in synchronous online class and ask students to collaborate. Or share the class materials in the jams for asynchronous class. Up to 50 students can collaborate and work on a jam at one time.

Google Jamboard web provides several advantages for online teaching especially on the layout of the screen with a small toolbar on the left side to reduce distractions, ability to create multiple pages inside a single jam, and enables others to get feedback on their work in a smoother, more dynamic interactive environment. Additionally, Jams can be downloaded as PDF documents and together with the Jam, links can be uploaded to the classroom course materials at the end of each lecture. Example of a page on the Jam is shown in Figure 1.

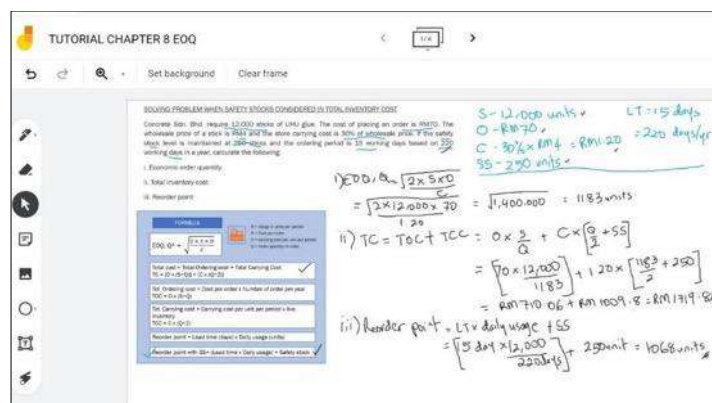

Figure 1 A Jam page for tutorial lesson in Financial Management (HFT20303)

Jamboard web app had been used as teaching enhancement tools for Financial Management course for students in the Faculty of Hospitality, Tourism, and Wellness (FHPK) during Movement Control Order (MCO). Using both synchronous and asynchronous method for teaching and learning this subject, the lecturer used the Jamboard web app in two-hour online teaching or recorded the tutorial. 276 students in semester February and 310 students in semester September 2020 participated in this online learning. Jamboard had been used for all 6 chapters that require calculation out of 9 chapters in the subject. A drawing pad and a stylus pen are used for the ease of using the Jamboard app. Ability to draw on top of the picture enables the lecturer to show students what to look for when solving a problem.

Using Jamboard in financial management class received positive feedback from the students for a few reasons. First, because it resembles a traditional whiteboard where the lecturer can easily explain the calculation step by step. Secondly, multiple pages allow solutions for several problems to be conducted without deleting the previous one. Finally, students are able to repeat learning through recorded videos and the PDF documents to fully understand the tutorials and be able to do the calculation by themselves.

The effectiveness of using Jamboard reflected in the better achievement in the subject during online learning (semester Februari and September 2020) compared to face-to-face teaching without Jamboard (semester September 2019). Figure 2 shows the comparison between the overall grade in the three semesters. The use of Jamboard helps students engage and understand better, which eventually leads to their ability to solve calculation problems. This finding was in line with several studies that show positive connections of interactive whiteboard usage with student achievement (Marzano, 2009; Ng et al., 2020; Smith et al., 2006). Jamboard as teaching tools could enhance student engagement and improve student's result. Another key point is the success of this tool with a condition that the lecturer provides quality content.

Google Jamboard web app is not only useful for teaching and learning enhancement but also for collaborative and interactive business meetings and training. Jamboard can enhance learning for various other courses besides mathematical and calculation subjects. While lecturers can add value by improving teaching and learning culture, engaging remote students, and improving cost since the app is available for free.

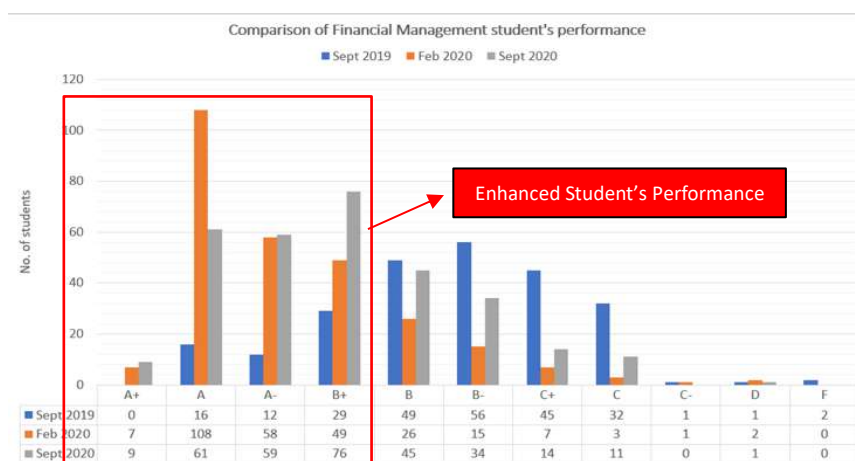

Figure 2: Comparison of Student's Performance Before and After the Use of Jamboard in Financial Management

Acknowledgement

We are entirely grateful to the immense and continuous motivation from Universiti Malaysia Kelantan for allowing us to conduct this study. We would also like to acknowledge the Faculty of Hospitality, Tourism and Wellness and the intensive support from the Center for Academic Excellence and Development (PKPA) of Universiti Malaysia Kelantan for support and feedback on all activities from the beginning to the end of the study.

References

- Marzano, R. J. (2009). Teaching with Interactive Whiteboards. *Educational Leadership*, 67(3), 80–83.
- Ng, O. L., Ting, F., Lam, W. H., & Liu, M. (2020). Active Learning in Undergraduate Mathematics Tutorials Via Cooperative Problem-Based Learning and Peer Assessment with Interactive Online Whiteboards. *Asia-Pacific Education Researcher*, 29(3), 285–294.
- Smith, F., Hardman, F., & Higgins, S. (2006). The Impact of Interactive Whiteboards on Teacher-Pupil Interaction in the National Literacy and Numeracy Strategies. *British Educational Research Journal*, 32(3), 443–457.

FAULT FINDER DEVICE FOR SINGLE PHASE INDUCTION MOTOR (FFIM)

Azani bin Mat Ali

Politeknik Kota Bharu, Ketereh, Malaysia
mataliazani@gmail.com

Mohd Rizuhan Bin Jaafar, Jafni bin Othman

Politeknik Kota Bharu, Ketereh, Malaysia
rizuhan@pkb.edu.my , jafni@pkb.edu.my

Highlights: The central concern of this innovation is to make students realize that actual steps must be taken during troubleshooting work in order to get actual result before repairing work done through accurate measurement assignment doesn't just only random troubleshooting, but also needs appropriate framework to make sure the troubleshooting, repairing is coherent, effective and interesting. The tools used are; single phase motor in good condition, a single phase motor in defective condition and digital multi meter to measure the coil resistance.

Key words: troubleshooting work, repairing work, good condition, defective condition, multi meter, coil resistance.

Introduction

Electrical Equipment Maintenance and Repair is a compulsory course for fifth semester students in Department of Electrical Engineering at Malaysia polytechnics. This course objective is to expose the students to the techniques of fault detecting and repairing the faulty household equipment. Lack of knowledges, experiences and exposures can make the students faced some difficulty in term to answer the final exam especially the essay question.

Content

1. Description of the innovation

A teaching aid known as Fault Finder for Induction Motor (FFIM) has been developed to strengthen the understanding of the circuit connection of a single phase induction motor, the basic principles of its operation and methods of fault detecting that occurs to the single phase induction motor.

Learning the circuit connection on a single phase induction motor by theoretical is insufficient without learning the actual physically connection of the motor. Students need to know some of the main parts of the motor such as coil, stator, rotor, shaft, and bearing and power input terminal. By using this teaching aid can help them to understand how to detect the faulty part of the equipment as well as to fix it into good condition which is the main objective of this course taught.

2. The context or background of the innovation

Existing learning methods are based on schematic diagram produced by the students then used it to make tracing the actual connection of industrial motor. This thing is slightly different of the syllabus which is required our students to make troubleshoot on domestic used motors that can be disassembled and then reassemble again into good condition.

3. The importance of this innovation to education

This FFIM Device innovation is produced using the Design Thinking Model method, which involves 5 processes namely Empathize, Define, Ideate, Prototype and Test. This FFIM innovation involves two new inventions, namely practical modules and learning modules that innovate in packages. This creative innovation product involves research on the construction specifications of a single -phase induction motor and accurate measuring the coil conductor resistance using a digital multi meter. Students need to know the value of the coil resistance accurately for a motor that is in good condition to make a comparison of readings for a damaged motor. Through this method students will be able to identify the damaged part quicker before performing the next step to fix the defective part.

The materials used are durable and easy to use, consisting of a single phase induction motor for portable home appliances such as a fan motor in good condition, a similar motor in defective condition and a digital multi meter. All the motors are ready in conditions for disassemble and reassemble.

4. Advantages of the innovation towards education and community

The result of an innovative product like this will be able to increase students' understanding of the basic construction concept of a single-phase induction motor, the function of each part as well as maintenance and repair methods that are very practical and usefulness as a teaching aid.

5. Commercial value in terms of marketability or profitability of the innovation

This innovation is marketable to all Malaysia Polytechnic which run Electrical Engineering program in their campus. The production cost is very cheaper which RM 150 per unit. Students can practice this innovation in order to make the practical work more fun and meaningful, what more the teachers teaching students at technical hand-on level. The approach used is very user-friendly and adjustable according to the needs of the subjects. The most important thing is the aim of this innovation in helping students score and do well in their practical work.

References

- Hamzah, M. Z. (2018). *Penyenggaraan Dan Pembaikan Elektrik*. Port Dickson: Politeknik Port Dickson.
- Herman, S. L. (2016). *Understanding Motor Controls*. Mason, OH, United States: Cengage Learning, Inc.
- Chapman, S. J. (2011). *Electric Machinery Fundamentals*. London, United Kingdom: McGraw-Hill Education.
- Herman, S. L. (2011). *Electrical Transformers and Rotating Machines*. Clifton Park, United States: Cengage Learning, Inc.
- Salam, M. A. (2011). *Fundamentals of Electrical Machines*. Oxford, United Kingdom: Alpha Science International Ltd.
- Theraja, B. (2014). *Textbook of Electrical Technology*. New Delhi, India: S Chand & Co Ltd.

FS MADE EASY TEMPLATE

Noraida Saidi

Universiti Teknologi MARA, Kelantan, Malaysia
noraida069@uitm.edu.my

Dr. Normaizatul Akma Saidi

Universiti Malaysia Kelantan, Kelantan, Malaysia
akma.s@umk.edu.my

Highlights: FS made easy was designed based on information received from students about the difficulty in understanding the accounting courses specifically preparation of financial statements' topic. Microsoft Excel was employed to record all the adjustments. By using this template, students can enhance their understanding of the double entry rules and enable them to record the adjustment transactions easily and prepare the financial statement correctly.

Key words: financial statement, adjustments template, non-accounting students

Introduction

The basic subject of accounting is a compulsory subject for non-accounting students who mostly do not have an accounting background. Thus, they face difficulties in understanding this subject, especially the topic of preparation of financial statements. This weakness also contributes to the failure of the final examination if this problem is not addressed because the questions on this topic contributes to a large weighting of 33% of the total marks. Previous studies have revealed findings from the perspective of teachers that the surface study approach used by non-accounting students have a negative impact on their studies' performance (Ismail & Kasim, 2011; Velasco, 2019). On the other hand, students had highlighted that the reasons for failure in the accounting course was due to difficult assessment as their inability to memorise rules or accounting concepts and terminologies in accounting well (Velasco, 2019). A new study approach needs to be identified to encourage students enjoying their accounting course during this online distance learning period. Thus, the objective of this study is to examine the level of understanding among non-accounting students in preparing financial statements pre and post of using FS Made Easy Template.

FS Made Easy Template

"FS Made Easy Template" has been produced to help students understand this topic easily and in turn be able to score high marks for this topic in the final tests and exams. This approach would enhance student's understanding on the double entry rules whereby they use Microsoft Excel to do the final year adjustments in a specific column of debit and credit before preparing financial statements. This would reduce the tendency of missing items in the financial statement as compared to traditional approach by focusing on the format of financial statements. FS Made Easy Template was shown below:



The image shows a screenshot of an Excel spreadsheet titled 'FS MADE EASY TEMPLATE'. The spreadsheet is organized into several columns and rows. The top section includes 'BALANCE SHEET' and 'INCOME STATEMENT' with columns for 'DEBIT' and 'CREDIT'. Below this, there are columns for 'ADJUSTMENTS' and 'ADJUSTED BALANCE'. The bottom section shows the 'FINANCIAL STATEMENT' with columns for 'DEBIT' and 'CREDIT'. The spreadsheet contains numerical data and text labels for various financial items.

Figure 1: The frontpage of FS Template Made Easy

Methodology:

This study has adopted pre and post approach in examining the level of students' understanding in preparing financial statements. 53 students who enrolled Financial Accounting subject have been approach and given a set of questionnaires to examine their level of understanding before and after using FS Made Easy template. They were given instruction to answer 1 past exam question without using FS template.

Next, they were given FS Made Easy template and a video explaining on how to use the template. After that, they were asked to prepare another set of question using FS Template Made Easy. Lastly, the questionnaires were distributed to examine their level of understanding before and after using the template. The questionnaires were designed with 5 Likert scales whereby score 1 represents the score for **very poor understanding**, 2 for **poor understanding**, 3 for **average**, 4 for **good understanding** and 5 for **excellent understanding**. 29 students have responded to the questionnaires within one-week time.

Novelty

FS Made Easy Template was designed using Microsoft excel with is easy to be used by the students and enhancing their double entry rules' understanding while preparing financial statements with final adjustments.

Advantages:

FS Made Easy Template is highlighting the double entry rule which provide more understanding to students as compared to using format-based approach when preparing financial statements with adjustments. By using this approach, student shall record the final adjustment entries with minimal error as every adjustment will be recorded twice for debit and credit entry. This study has shown some improvement of participants' understanding in preparing financial statements after using the template as shown below:

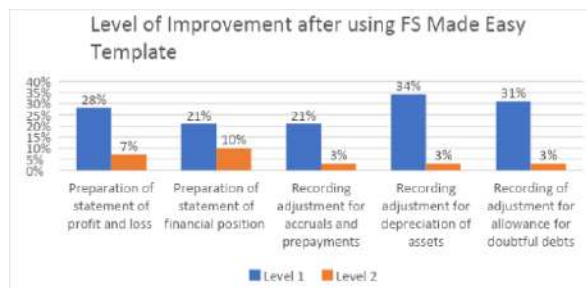

Chart 1: The findings after using FS Template Made easy

Level of improvements indicates the improvement of score by the respondents before and after using FS Made Easy Template. Level 1 means the respondents have rated 1 score higher after using the template. For example, before using the template, the respondent chose scale 1 (very poor understanding) for a recording adjustments for accruals and prepayments. Then, after the invention using the template, the respondent give scale 3 (average understanding). Therefore, this shows 2 level of improvement from scale 1 to scale 3. In addition, the above chart has shown that the highest improvement was in terms of recording the adjustments for depreciation of assets (34%), followed by recording adjustment for allowance for doubtful debts (31%), preparation of statement of profit or loss (28%), and preparation of statement of financial position and recording for accruals and prepayments (21% each). Next, two (2) level of improvement scored by the respondents after using FS Made Easy Template was preparation of financial position's statement (10%), followed by statement of profit or loss (7%), and 3% of the respondents showed two level of improvements in recording all the adjustments for accruals and prepayments, depreciation and allowance for doubtful debts.

Commercial Value

This template can be introduced to all non-accounting students who enrolled financial accounting courses to improve their understanding in preparing financial statements.

References

- Ismail, S., & Kasim, N. (2011). Accounting for Non-Accounting Students: What Affects Their Performance? Accounting for Non-Accounting Students: What Affects Their Performance?, 3(2), 19-32.
- Velasco, R. M. (2019). Factors associated with failure in accounting: A case study of the Omani students. International Journal of Higher Education, 8(6), 157-170. <https://doi.org/10.5430/ijhe.v8n6p157>

MAGIC PIZZA FLOUR

Hanirah Binti Mohamad Nur

Kota Tinggi Community College, Johor, Malaysia
hanirah@kkkotatinggi.edu.my

Hasniza Binti Tawyer, Mohd Ramadan Bin Mohd Khalid

Kota Tinggi Community College, Johor, Malaysia
hasniza@kkkotatinggi.edu.my, ramadan@kkkotatinggi.edu.my

Highlight: Community College, Ministry of Higher Education offers lifelong learning programmes based on public and industry demand. Cooking classes are among the courses that receive high demand and are able to attract public that has led into the introduction of a product known as Magic Pizza Flour (MPF). MPF is a product innovated during the implementation of teaching & learning for the short course. This product enables consumers to prepare their own preferred pizza that used to be difficult into a simple method with complete nutrition as well as time and cost effectiveness.

Key words: *lifelong learning; community; nutritious flour; product innovation*

Introduction

The changes in human demographics and lifestyles have led to rapid developments in food technology industry and contribute to the growth of the food industry in Malaysia. For instance, western food products such as pizza, have become a normal menu for Malaysians. According to the 2010 Dietary Guidelines for Americans, pizza is the most important source of calories in Europe for adults and children of two years of age and older. Similarly, in Malaysia, the demand for pizza is so encouraging and currently there are 18,703 Pizza Hut outlets and 17,000 Domino's Pizza outlets nationwide (2020).

The context or background of the innovation

Based on survey, it was revealed that consumer preference to consume pizza at the fast-food restaurant, among other reasons is due to consumer incapability to prepare pizza on their own apart from the service and atmosphere provided by the restaurant. Consumers are of the opinion that preparing pizza at home is impossible due to lack of knowledge and tedious method of preparing pizza. The survey results also indicate that consumers would not hesitate to prepare pizza at home provided there is a product in the market that would simplify the process of preparing a pizza. It was also found out that there are bakery enthusiasts among Malaysians that are unable to perform and practise their hobby towards baking due to time constraints factors. For bakers' enthusiasts, preparing pizza from scratch would cause their precious time and cost to be wasted. Therefore, this product would enable consumers and bakery enthusiasts to save their time and cost since MPF is simple to use and time efficient.

Figure 1: Product Development Process & How to Make Pizza

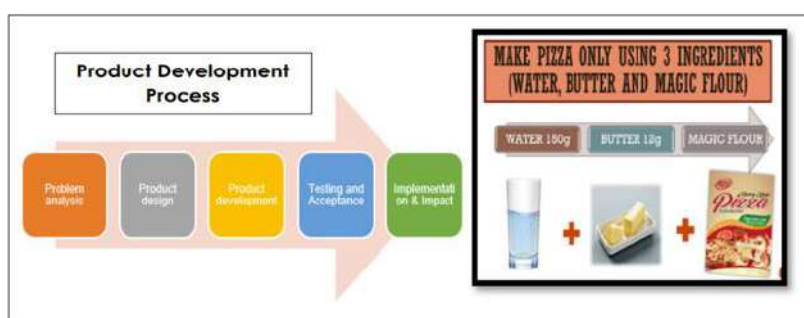

Description of innovation

MPF is a premix pizza flour to produce pizza dough. The premix is a combination or mixture of several pre-weighted ingredients such as whole meal flour, sugar and salt. This product enables consumers to prepare and bake pizza in a simplified method, saving time and cost. MPF will become an alternative choice to pizza and bakery enthusiasts.

Why are they important to education?

MPF is definitely suited and complement the purpose and objective of lifelong learning education program offered by the community colleges. This product was innovated and dedicated to short course participants as well as to the instructor and this product is proven to be easily prepared, save time and cost effective.

Advantages of innovation/ Product Uniqueness

- **Newly innovated**

There are no other pre mix products in Malaysian market for the preparation of pizza dough. It would allow pizza enthusiast to easily bake their own pizza effortlessly with their own choice of topping dishes and most of all it will enable a consumer who afraid or don't know how to prepare pizza to experience the "feel" of baking their own pizza. With this innovation, now everyone has the opportunity to bake and prepare pizza of their own choice regularly and make pizza as a preferred meal for the whole family.

- **Healthy Product**

MPF is good for health since the ingredients of the product is using whole meal flour. Research has already proven that whole meal flour is highly beneficial for health since the nutrition is higher compared to white flour. Whole meal flour is rich in Vitamin B1, B2, B3, E, calcium, phosphorus, folic acid, copper zinc, iron and fibre. Researcher claim that whole meal flour benefits to health and would be able to control obesity and improve body metabolism.

- **Save time and cost.**

MPF offer time and cost efficiency. Preparation of pizza dough requires shorter period in terms of kneading the flour to prepare the dough. Traditional method requires 2 hours for dough to be prepared while it takes 55 minutes using MPF. The product is easy to use since it was pre-weighed and therefore it would optimise the use of flour and simultaneously saving cost. MPF is also easy and convenience for storage.

Table 1: Save time of Preparation

MANUAL	TIME	TEPUNG MAGIC PIZZA	TIME
Knead the dough	30 minutes	Knead the dough	10 minutes
Rest the dough	1 hour	Rest the dough	30 minutes
Rest the dough for the second time	30 minutes	Rest the dough for the second time	15 minutes
2 HOURS		55 MINUTES	

- **Can be cooked using pans (oven is not compulsory)**

Traditional method requires pizza to be baked in hot oven. Alternatively, MPF dough however would be able to be cooked/baked using a pan provided that the pan is covered during the process of cooking/baking. This method enable consumer to less dependent on oven to bake the pizza dough.

Commercial value / product development / design

This product has also been registered with the Malaysian Intellectual Property Corporation (**MYIPO**) **LY2018006006** and has been sent to **Eurofins NM Laboratory** for a nutrition report. This product has sold over 3000 packs since its introduction in mid - 2019. In the packaging box, there is also a QR code that linked to a video of making pizza using MPF.

References

- 2010 Dietary Guidelines for Americans (2020, Nov 12) <https://health.gov/our-work/food-nutrition/previous-dietary-guidelines/2010>.
 Soo San, H. (2006). Penghasilan Snek Biskt Daripada Beras Dengan Rumpai Laut (*Eucheuma cottonii*).
 Mansor, A. B. A. (2006). Kajian Tabiat Berbelanja Ke Atas Makanan Segera Di Kalangan Pelajar, 1–39.
 Pizza Hut (2020, Dec 24) https://en.wikipedia.org/wiki/Pizza_Hut

MULTIMETER KIT'S

Khetijah binti Samat

Politeknik Kota Bharu, Ketereh, Malaysia
Khetv7366@gmail.com

Julia Izura binti Jopely, Nor 'Aziah binti Abdullah

Politeknik Kota Bharu, Ketereh, Malaysia
juliaizura@pkb.edu.my , noraziah@pkb.edu.my

Highlights: Every semester one student of Electrical Engineering must take the Measurement Devices course. This course involves the measurement of electrical parameters and a multimeter is one of the measurement meters that need to be studied and used during the teaching and learning process. Some students find the use of a multimeter very difficult specially to select and relate ranges and scales. This negative perception causes a large number of students to be unskilled in using multimeters. A new material on multimeters is multimeter kit's that are designed to make it easier for students to use multimeters in selecting ranges and scales with wright polarity. Students often complain that the multimeter malfunctions after using it several times to measure voltage, current and resistance. This is due to students experiencing confusion to select and correlate between ranges and scales for the measurement of electrical parameters (V, A and Ω). Existing multimeters have range and scale displays for all parameter measurements (Arun, 2012). Students need to be proficient in relating ranges and scales of measurement. This innovation uses three types of kits consisting of ranges and scales for voltage, current and resistance measurements. These kits are made from prospects cut into three parts and each part is accompanied by a description of electrical parameter measurement. Each prospect is designed for one kit that has one measurement function (V, A and Ω). Each time the measurement is done, the student only needs to attach the kits according to the type of range desired and directly the student knows the scale to be read. This innovation has been tested on several students. Each student was given kits to use on the multimeter according to the electrical parameter measurement function. As a result of this test, it was found to have successfully avoided the confusion of students choosing and correlating between the range and scale of the multimeter which caused the multimeter damage to be overcome.

Key words: *measurement, student, perception, select, correlate, confusion, scale and range*

Introduction

Every semester one student of Electrical Engineering must take the Measurement Devices course. This course involves the measurement of electrical parameters and a multimeter is one of the measurement meters that need to be studied and used during the teaching and learning process. Some students find the use of a multimeter very difficult specially to select and relate ranges and scales. This negative perception causes a large number of students to be unskilled in using multimeters. Students often complain that the multimeter malfunctions after using it several times to measure voltage, current and resistance. This is due to students experiencing confusion to select and correlate between ranges and scales with wright polarity for the measurement of electrical parameters (V, A and Ω). Existing multimeters have range and scale displays for all parameter measurements. Students need to be proficient in relating ranges and scales of measurement.

Content

1. Description of the innovation

This innovation uses three types of kits consisting of ranges and scales for voltage, current and resistance measurements. These kits are made from prospects cut into three parts and each part is accompanied by a description of electrical parameter measurement (Nor azura et al., 2016). Each prospect is designed for one kit that has one measurement function (V, A and Ω). Each time the measurement is done, the student only needs to attach the kits according to the type of range desired and directly the student knows the scale to be read. The cost RM20.00 for each kit and the Multimeter kit's box set costs RM150.00.

2. The context or background of the innovation

This innovation is applying the Design Thinking as problem solving approach and involving five phases-Empathize, Define, Ideate, Prototype and Test. It is a contemporary approach that is human-centric. It focuses on the client's requirements and needs, which is essential in the innovation for delivery of services. Empathic is based on the five-stage Design Thinking process. At this stage, the researchers try to be empathic in order to understand how to use multimeter with respects electrical compliance for the learners at Kota Bharu Polytechnic.

Table 1: Methods of the empathic stage

Item	Method	Description
1.	Observe	Make observations while students carry out practical work for measurement task by using the wright device to measure the electrical parameters
2.	Engage in practical work	Group members have also tried to do the practical work process to find out the problems faced by students while doing practical work in the laboratory carry out practical work for Measurement Devices course in the Instrumentation laboratory.
3.	Interviews	Interviews of students and course lecturers were conducted and information was recorded for analysis.
4.	Questionnaire	Questionnaires were also conducted to collect information from students and lecturers involved

At define the problem stage, the researchers analyse the information that they have gathered and synthesise them so that they can identify and define the problem in a human-centred way. The researchers also discuss ideas to solve these problems.

Table 2: Define the problem stage

Interesting Information	Data	Discovery	We Want to Help
1. Take Time	Engage in practical work	From observations, students are confused to select the correct range or scale for the electrical parameters that need to be measured, causing a lot of time wasted.	Measure using the wright range and scale for wright electrical parameters
2. Broken multimeter	Observe	From observations, as a result of the measurements performed, it was found that the readings obtained were no readings.	Need a suitable measurement kit
3. Choosing the wrong scale and range	Interviews	As a result of the measurements made, it was found that the readings obtained were wrong from the theory due to the wrong selection of the correct range and scale.	Using the wright template for the wright electrical parameters
4. Incorrect circuit connection	Questionnaire	Students often make mistakes in the required polarity of circuit connections.	Simple circuit connection

As a result of generating creative ideas, group members agreed to create a Multimeter Kit`s that could solve related problems. Taking into account low cost, fast implementation, high impact and sustainability. SWOT analysis is used to complete the recommendations that have been made, the results of the trainer build team members by producing a prototype first. Group members have produced the first prototype and improved on the second prototypes which is better and more appropriate. In addition, the group has produced a complete set of components to facilitate the testing process. Testing and implementation were conducted in an Instrumentation laboratory, Department of Electrical Engineering, Kota Bharu Polytechnic, to collect data and evaluate the effectiveness of the project.

3. The importance of this innovation to education

The idea for this project is based on creativity which is translated into an innovation that benefits the end users, namely the students. It's fulfils clients' expectations to improve their measurement skills. Besides that, this innovation also can save time through user-friendly innovation, eliminates mistakes through the structure of the trainer and saves cost because the project does not require the use of expensive-high end materials. It is very flexible and can be used by students in all levels of proficiency.

4. Advantages of the innovation towards education and community

This innovation consists of a complete package of measurement electrical parameters, module notes and a trainer box with an interesting meet and match puzzle module concept. It is able to increase students' understanding of measuring concepts more easily. Students can use the tool without complete assistance from the lecturer as all the notes and manuals are already available. The materials used are easy to carry anywhere and durable.

5. Commercial value in terms of marketability or profitability of the innovation

This innovation is not only suitable for use in the Department of Electrical Engineering, Kota Bharu Polytechnic but also for all Malaysian polytechnics (33 polytechnics and Malaysian Community Colleges (79 Malaysian Community Colleges). It's can also be applied in IPTA and IPTS in the field of Electrical Engineering and has the potential to be commercialized for all educational institutions either locally or international. In addition, it can be used by various courses that have a syllabus that consist of the use of analogue multimeter as a measurement tool (Stephen, 2016). Besides that, it's also can be used for various levels of study in engineering and these skills will also always be used in careers (engineering).

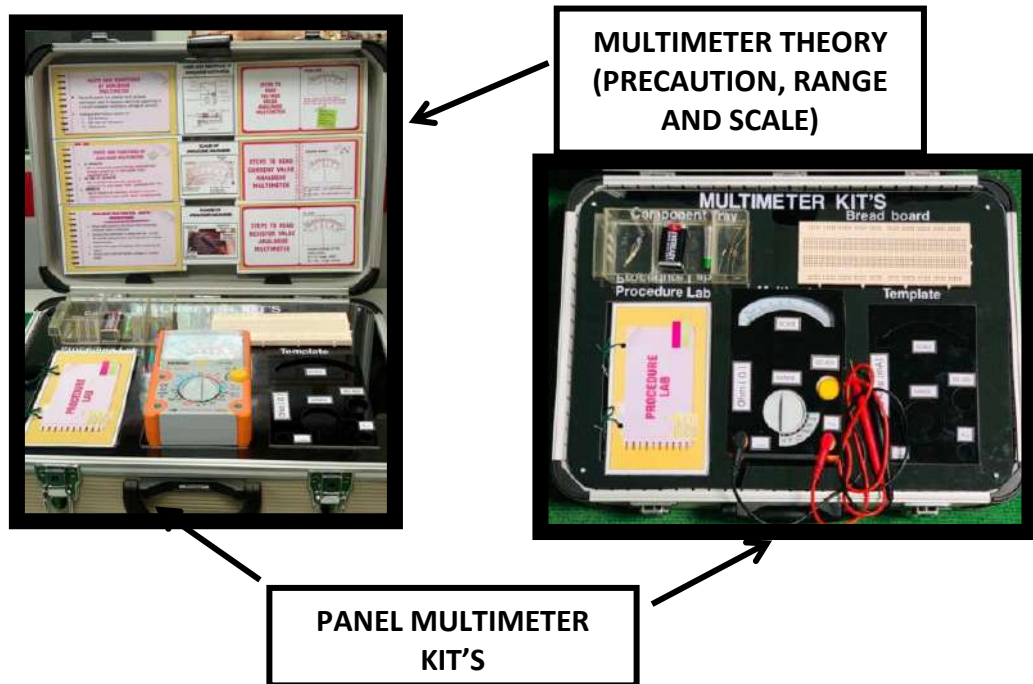

Figure 1: The main components in the Multimeter Kit`s

References

- Arun K. Ghosh. (2012). *Introduction to Measurement and Instrumentation*. New Delhi: PHI Learning Private Limited.
- Nor azura, Khetijah & Munirah (2016). *Measurement Polytechnic Series*, Malaysia: Oxford Fajar.
- Stephen L. Herman. (2016). *Delmar's Standard Textbook of Electricity*. Boston USA: Cengage learning.

MOBILE EDUCATIONAL APPLICATION: SMART CASH FLOW

Nur Afifah Binti Ahmad

Politeknik Kota Bharu, Ketereh, Malaysia
afifah@pkb.edu.my

Norzaiti Aktar Binti Mohamed

Politeknik Kota Bharu, Ketereh, Malaysia
norzaiti@pkb.edu.my

Highlights: In education field, the use of mobile application in learning is gaining more traction. Mobile application is an approach that could draw interest in students to learn certain complicated subjects. Smart Cash Flow, an educational mobile application was established in recognition of the relevance. This is an innovation in Teaching and Learning process for Statement of Cash Flow topic under the Financial Accounting course. The goal of establishing this innovation was to make it easier for students to comprehend and apply the known to be as the most critical topic in financial accounting which is Statement of Cash Flow. This mobile learning innovation is in line with the latest educational technology development that requires a more creative, innovative and interactive teaching technique. This multimedia innovation does not only fulfil the curricular criteria for the said topic but also indirectly heighten students' interest towards effective learning. This software was developed by using Microsoft Power Point and Google Flutter Framework.

Key words: *Mobile Application, Statement of Cash Flow, Accounting, Teaching and Learning*

Introduction

Mobile communication technology has given rise to a variety of alternatives and the best options for communication facilities. Mobile phones, for example, are no longer limited to receiving and making calls, but also to give the convenience of using it for learning, sale and purchase transactions and management. (Jonassen, 2000; Grabe & Grabe, 2004)

Accounting is viewed as one of the aspects affected as a result of the wave of globalization, which is in accordance with the world's development in the sphere of information and communication technology. Previously, the process of teaching and learning in accounting field only take place in lecture halls, with reference books being the only source of information. Nowadays, accounting knowledge may be accessed through various streams such as websites, YouTube, social sites and social applications with a few clicks or taps on the screen display of mobile phones, thanks to the internet's availability (Mohd Aliff, Ezad Azraai, Mohd Isa & Azizi, 2012).

Background of Mobile Educational Application: Smart Cash flow

Educators and researchers in the field of education have also emphasized the use of applications to supplement the existing system. This is in keeping with the nature of technology, which has no limits or boundaries and is constantly evolving from day to day, added by continuous encouragement from the ministry (Ahmad Zaki, 2015). The use of mobile application in learning is gaining traction in the field of education. This mobile application is an approach that can entice students to study in complex and challenging subjects. As a result, the researcher took the initiative to develop Smart Cash Flow, a mobile educational application. It was created as one of the options for engaging students in learning and assisting them in comprehending the concept of Statement of Cash Flow, which is regarded one of the most critical financial accounting topics to be comprehended and applied.

Description of Mobile Educational Application: Smart Cash flow

This mobile educational application: Smart Cash Flow was develop by using two software which is Microsoft Power Point and Google Flutter Framework. In addition to being operated on android devices, the application can also be operated on computers or laptops in windows systems. Smart Cash Flow can be downloaded from Android and Google Play Store in smartphones. It can be used by students as a medium of communication, reference and practice.

Nine elements are features in this application. Among them are complete notes on Statement of Cash Flow, adjustment accounts, Statement of Cash Flow Types and a comprehensive collection of examples with questions and answers. In addition, the mobile application Smart Cash Flow offers a quiz-style assessment to verify students' comprehension on the subject. Students can directly evaluate whether or not the assessment is answered correctly. Accordingly, as an added value to the students, this application includes a learning video on the Statement of Cash Flow that can be replayed.

Findings

Initially, the teaching and learning (P&P) of Topic 5 Statement of Cash Flow uses existing notes. A total of 150 individuals from third and fifth semester students were selected as study sample. The data was then analysed using Google Form based on three factors, namely the concept of teaching and learning, multimedia elements and user-friendly features. The finding of this study shows that the developed mobile application: Smart Cash Flow meets the needs of their teaching and learning process.

The result of the study shows that 74% of students strongly agree that this application aids in the teaching and learning process, 64% strongly agree that it has multimedia elements and 68% strongly agree that it is user friendly. It is apparent from these data that these innovations have a positive impact on the student. Figure 1 below illustrates the positive impact of usability of Mobile Educational Application: Smart Cash Flow.

Figure 1 Usability of Learning Innovation

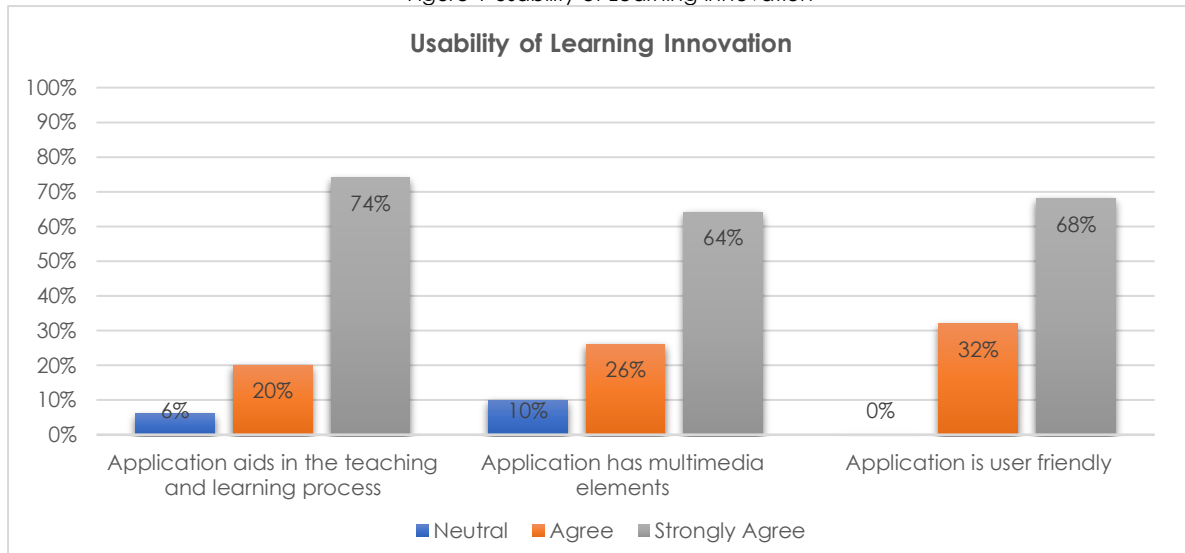

Advantages of Mobile Educational Application: Smart Cash flow

The advantages of this innovation is to improve students' abilities and mastery in the topic of Statement of Cash Flow in a faster, easier, more accurate and error-free manner. The following are the objectives of this innovation;

1. Improve students' comprehension of Topic 5 Statement of Cash Flow
2. Produce a format that facilitates student learning
3. Be one of students' reference material for self-learning process
4. Determine the current balance of cash value more accurately and comprehensively.
5. Minimize the cost, time and energy of lecturers and students.
6. Optimize the utilization compared to other media such as E-Learning that needs an internet connection to access it.

Importance to Education

The idea for this application is based on creativity which is translated into an innovation that benefits the end users, namely the students. The development of these innovations also has an impact to ensure that the Department of Commerce's aim of reducing the number of students who are academically poor and increasing the number of students who obtain good results in the final examination is met. The application is free and the process of spreading its use to students does not involve any cost through the use of application

Commercialization

Mobile Application: Smart Cash Flow satisfies the demands of self-learning, particularly among Diploma in Accounting of the Department of Commerce at Politeknik Kota Bharu students taking the course DPA30053 Financial Accounting 3. The use of this application becomes increasing crucial, especially in the era of the Covid-19 pandemic where online learning is the major platform for the teaching and learning process at Politeknik Kota Bharu. This application is appropriate for students in polytechnics throughout Malaysia and higher education students pursuing related courses. This application also has the potential to be commercialized for all educational institutions either locally or international.

Conclusion

In conclusion, the development of this mobile application was effective that it has the potential to be implemented in teaching and learning. Mobile application: Smart Cash Flow is very important and appropriate in

helping to implement more effective teaching and learning in the Industrial Revolution 4.0 age. In accordance with the widespread usage of technology, it further strengthens the findings of the study that Mobile Application: Smart Cash Flow requires less time to master and save time. The findings of this study demonstrate that mobile applications have a positive influence in terms of its usability as well as influence of its use on users as educational needs of Industrial Revolution 4.0 and are also acceptable for use by individuals in the accounting field. Despite the various limitations and constraints encountered, it is anticipated that all concerns and perspectives on this mobile application will serve as a guide for researchers in the future improvement on the development of this application.

Acknowledgement

Mobile Application: Smart Cash Flow has been registered under Intellectual Property Corporation of Malaysia (MyIPO) for copyright.

References

- Ahmad Zaki bin Amiruddin, Madya Dr Kamarulzaman bin Abdul Ghani, Ahmed Thalal bin Hassan, Ahmad bin Abdul Rahman, Qaziah Fatimah binti Berhanuddin (2015). Aplikasi e-Pembelajaran Untuk Proses Pembelajaran dan Pengajaran Bahasa: Fungsi & Kelebihan. Presented in Seminar Antarabangsa Pendidikan dan Keusahawanan Sosial Islam (ICIESE 2015) on 12-14 Oktober 2015.
- Jonassen, D.H. 2000. Computers As Mindtools For Schools: Engaging Critical Thinking. 2nd ed. New Jersey: Merrill Prentice Hall
- Mohd Aliff Mohd Nawī, Ezad Azraai Jamsari, Mohd Isa Hamzah & Azizi Umar. (2012). The Impact of Globalization on Current Islamic Education. Australian Journal of Basic and Applied Science. 6(8): 74-78.
- Naismith, L., Lonsdale, P., Vavoula, G., & Sharples, M. (2004). Literature Review in Mobile Technologies and Learning. Retrieved on August 11, 2012, from http://www.futurelab.org.uk/research/reviews/reviews_11_and12/11_01.htm
- Roshayani Arshad, Laily Umar, Siti Maznah Mohd Arif (2006). Financial Accounting and Introduction, Second Edition. McGraw-Hill, Selangor.
- Syafiza Abd Wahab. (2007). Mobile Learning Notes for SPM Sejarah: Islam di Asia Tenggara. Latihan Ilmiah. Fakulti Teknologi dan Komunikasi Maklumat. Universiti Teknikal Malaysia Melaka.
- Zoraini Wati Abas, Tina Lim, Harvinder Kaur Dharam Singh & Wei Wen Shyang. (2009). Design and Implementation of mobile learning at Open University Malaysia (OUM). The 9TH SEAAIR Annual Conference, hlm. 439-445.Pfeiffer.

“POGRAM MINI PROJECT” GOOGLE SITES AS AN INNOVATION IN STUDENTS’S PROGRAM IMPLEMENTATION

Nurliyana Husna Binti Ramli

Politeknik Kota Bharu, Kota Bharu, Malaysia
nurliyana@pkb.edu.my

Mohd Faizal B Ismail¹

Politeknik Kota Bharu, Kota Bharu, Malaysia
faizaljmsk@pkb.edu.my

Highlights: “Program Mini Project” Google Sites is an innovation in implementing student programs. Based on the COVID 19 pandemic that is still plaguing the country, institutions should diversify methods so that student programs can still be implemented even without face to face. The Department of Mathematics, Science and Computer, Kota Bharu Polytechnic should also implement all student activities online. The Mini Project program for the DBS10012 course implemented by JMSK also needs to use the online method.

Key words: Google, sites, online, PdPR, Program Mini Project, student's excellence program.

Introduction

Program Mini Project is one of the student's excellence programs that implemented by Jabatan Matematik, Sains dan Komputer (JMSK), Politeknik Kota Bharu. This program should be conducted face to face because it's a competition but unfortunately the pandemic COVID 19 causing Malaysia to implement Movement Control Order (MCO) to curb this epidemic from continuing to spread. This situation caused all educational institutions to be closed and all PdP processes to be conducted online.

Thousands of new application has being created and increasingly being used for personal matters, educational and management (Mohd Nazri Md Saad, 2017). Therefore, all educational institutions in the country have diversified online methods to improve to quality of their respective online teaching and learning (PdPR) .

Hence, JMSK has taken the approach of implementing the program online. All mini projects competed will be gathered in one place to facilitate all jurors for access. The method used is to develop Google sites which will be accessible to everyone.

Google Sites enables any user invited to join a site to edit pages without requiring knowledge of Web coding or design. Individual team members can also create profile pages of their activities, interests and schedules. In school settings, Google Sites can function as virtual classrooms for posting homework assignments, class notes or other student resources (Auchard, 2008).

Content

Based on the Pandemic COVID 19 that occurs in our country, The Department of Mathematics, Science and Computer, Kota Bharu Polytechnic should also implement all student activities online. According to Noriyani (2017), advances technologies that can save time and energy consumption and even facilitate the transformation and transfer of information to move and occur in cyber or virtual space that has no specific location, is now becoming a reality in the world of teaching in Malaysia.

Therefore, the Mini Project Program for the DBS10012 course implemented by JMSK took the initiative to build a website using Google Sites. Google Sites allows non-technical users to organize and share digital information such as Web links, calendars, photos, videos, presentations, attachments and other documents in an easy-to-maintain site (Auchard, 2008). Google Site is an application provided free of charge to Google users. One of the uses and benefits that can be taken from this Google Site application is that it is suitable to be used as a platform to collect various relevant and appropriate materials.

Thus, a Google sites has been created to enhance the outcomes that can be achieved by students in particular and departments in general for this Program Mini Project. The main objective of this site to provide a platform where all the program's competitor can get the information about this program/competition. Not only that, the jury can also access all the mini projects in these sites. Its the latest method used by JMSK, PKB and first time used. This sites will be a platform where all information about the Mini Project Program can be accessed by students and staff of JMSK anytime and anywhere.

Program Mini Project sites has 5 main menu. All the menu has their own function. The first menu is Home where all the viewer can see the background information about this program. The second menu is Syarat Pertandingan which is include the competition instruction and requirement that have to be followed by the participants. The third menu is Senarai Video. In this menu, all the video from the participant are uploaded. All the participants have their own ID. So the jury were able to identify each participant more easily and the jury will be able to evaluate each mini project in this menu. The forth menu is Maklum Balas Peserta, where all the participants can fill the Google Form to give their feedback about this program. And the last menu is Senarai Pemenang. This menu only appear when the program is done. This menu is generated for encourage the students to more participate in the institutional activity.

The advantages for this innovation is it can provide special platform to collect all the information about the Mini Project Program where students can easily access all the information about these program. Besides that, the jury was also able to evaluate all the mini -projects more easily and it's because each project had a specific ID No. Not only that, all polytechnic students and staff can see the student's mini projects.

Mini projects produced by students can also be disseminated to all students and staff of Politeknik Kota Bharu. It also able to increase students' enthusiasm to produce better projects. This site also accessible to all other polytechnic residents, especially students who take the DBS10012-Engineering Science course. The implementation of Google Sites has had a remarkable positive impact on the students since an overwhelming majority of students perceived the use of Google Sites as an innovative learning technology as a major enhancement in improving their general computer knowledge (Sumarie & Carina, 2012).

For the conclusion, the implementation of Google sites can be one of the innovations in education and can overcome the problem of educators who can't implement the face to face method with their students. From this site, we can create one platform that gathers all the information regarding the Mini Project Program. Every latest information can be updated from time to time and can be accessed by other polytechnic residents without time constraints. Lastly, these sites can provide early exposure to students who have just registered for the DBS10012 course on Mini Projects.

Acknowledgement

Thank you for all staff at Jabatan Matematik, Sains & Komputer in Politeknik Kota Bharu who are directly or indirectly involved to complete this extended abstract

References

- Auchard, E., (2008). Google Offers Team Web Site Publishing Service. Achieved on 11 Julai 2021.
http://web.archive.org/web/20080302210238/http://news.yahoo.com/s/nm/20080228/tc_nm/google_sites_dc_1 Azia Idayu Awang, Azhari Zakaria, Hardya Bujang Pata, Khairani Yaakub, Noor Affandee Abdul. (2015). Engineering Science, Polytechnic Series, Shah Alam:Oxford Fajar Sdn. Bhd.
- Mohd Nazri Md Saad. (2017). Perkembangan Media, Multimedia dan Teknologi Maklumat Masa Kini. The International Conference on Development of Education, Environment, Tourism, Economics, Politics, Arts and Heritage (ICDETAH2017), Universiti Pendidikan Sultan Idris.
- Noriyani Binti Doman (2017). Implikasi Google Apps dalam Pengajaran Dan Pembelajaran Pelajar Pesisir UTHM. Fakulti Pendidikan Teknik dan Vokasional UTHM. Achieved on 11 Julai 2021.
<https://core.ac.uk/download/pdf/141497907.pdf>
- Sumarie Roodt & Carina de Villeirs (2012). Using Google Sites As An Innovative Learning Tool At Undergraduate Level In Higher Education. AIS Electronic Library, ECIS 2012 Proceeding. Achieved on 11 Julai 2021.
https://www.researchgate.net/publication/287242421_Using_google_sitesC_as_an_innovative_learning_tool_at_undergraduate_level_in_higher_education

INSTASPACE MODULE

Fariha Diyana Binti Awang Ali

Universiti Selangor, Selangor, Malaysia
fariha@unisel.edu.my

Muhammad Anwar Bin Mohd Kamal, Mirza Madihah Bt Zainal, Jayemogen a/l Shanmugam

Universiti Selangor, Selangor, Malaysia
anwarkamal@unisel.edu.my, mirza@unisel.edu.my, jayemogen@unisel.edu.my

Highlights: Instaspace module is a teaching module that provides a guide to ESL instructors to maximize the use of Instagram in teaching and learning sessions during this Covid-19 pandemic situation. This module contains 7 lessons consisting of various teaching methods by integrating four language skills (reading, writing, listening and speaking). The target audience of this Instaspace module are the ESL high school, college and university students.

Key words: *Instagram, lesson, modules, teaching and learning, ESL, language skills*

Introduction

The use of social media becomes more popular for the students nowadays. One of the popular social media is Instagram. During this Covid-19 pandemic, the application of ESL teaching and learning process via Instagram can be seen as an effective approach to engage students in ESL classroom (Handayani, 2016; Purnama, 2018). However, ESL instructors need to be given a guide to maximize the use of Instagram as a platform in teaching English that is highly preferred by students (Li, 2016). All conceivable dimensions were studied, discussed, and the primary aspects considered crucial for instructional process and instructional design were elicited as main dimensions in order to construct the theoretical underpinnings behind this Instaspace module. Keeping in mind that the degrees of learning goals that instructors intend to teach, as well as pedagogical difficulties, are crucial in the selection of social media, four dimensions are regarded as the most essential factors that might forecast the best fit of Instagram (refer Figure 1).

Figure 1: Framework of Instaspace Module



The items of each dimension are presented below:

1. Instructional Strategies: Asynchronous learning (Hrastinski, 2008)
2. Knowledge Levels refers to the level of learning goals that instructors plan to teach in their courses as the cognitive dimension of Bloom's taxonomy.
3. Content types as (a) Text, (b) Video, (c) Audio, (d) Visual – such as pictures, drawings, diagrams, concept maps, charts
4. Assessment: Alternative and Classic Assessment (Presley & McCormick, 2007).

Content

Therefore, this Instaspace module consists of seven lessons, each focusing on a different teaching strategies and instructional approaches by integrating the four language skills (reading, writing, listening and speaking) to emphasize the holistic nature of English language (refer Table 1). The lessons are designed to be completed by the ESL instructor one per week in sequence, throughout the course of a seven-week of short semester teaching session.

Table 1: Instaspace modules

Lesson	Title	Language Skills
Lesson 1	Teen slangs	Speaking
Lesson 2	Health is Wealth	Writing & Reading
Lesson 3	Food & Culture	Writing & Reading
Lesson 4	Life Hacks	Listening & Speaking
Lesson 5	Time Management	Writing
Lesson 6	Sport & Recreation	Listening & Speaking
Lesson 7	Teen & Relationship	Speaking

The use of Instagram will be maximized by the ESL instructor in each module for pre, while and post teaching sessions. Therefore, each Instaspace lesson consists of lesson objectives, '3 stages lesson planning', virtual teaching aids, virtual quizzes, virtual tasks and supplementary resources. These lessons are developed by adapting the Sociocultural Learning Theory. The Sociocultural Learning Theory is founded on the notion that a learner's environment has a significant impact on his or her learning growth. According to Vygotsky, the learning process comprised of three major components: culture, language, and the "zone of proximal development" (Vygotsky, 1978). Hence, Instaspace lessons adapted this theory by using authentic cultural materials and social media technological features to provide substantial scaffolding of learning content and real-life experience.

This Instaspace module serves as an effective guide for today's ESL classroom as it will give beneficial effects in improving students' language skills and boost students' motivation. It allows ESL educators to communicate with students beyond office hours virtually. It also allows students to generate ideas with contextually relevant content and offers them a real-life learning experience that they enjoy. Most other commercially published courses are published to guide ESL instructors to have teaching and learning ESL courses with the aid of existing education-based platform. However, Instaspace module is prepared to help Malaysian ESL instructors in engaging students during this Covid-19 pandemic through Instagram.

Acknowledgement

We want to thank the ESL instructors of Centre for Foundation and General Studies UNISEL for their cooperation in implementing this module.

References

- Handayani, F. (2016). Instagram As a Teaching Tool? Really? In Proceedings of the Fourth International Seminar on English Language and Teaching (ISELT-4) (pp. 320–327). [https://doi.org/10.1016/0022-328X\(84\)85193-1](https://doi.org/10.1016/0022-328X(84)85193-1).
- Hrastinski, S. (2008). Asynchronous and synchronous e-learning. *Educause quarterly*, 31(4), 51–55. Retrieved from <https://net.educause.edu/ir/library/pdf/eqm0848.pdf>
- Li, J. (2016). Social media and teacher education: The case of STARTALK.
- Purnama, A. D. (2018). Incorporating Memes and Instagram to Enhance Student's Participation. *Language and Language Teaching Journal*, 21(1), 94–103.
- Presley, M., & McCormick, C. (2007). *Cognition, Teaching, and Assessment*. Harper Collins College Publishers.
- Vygotsky, L. S. (1978). *Mind in society: The development of higher psychological processes*. Cambridge, MA: Harvard University Press.

A SHORT VIDEO ON JOB INTERVIEW

Noor Asmaa' binti Hussin

Politeknik Kota Bharu, Kelantan, Malaysia
asmaa@pkb.edu.my

Kamilah binti Zainuddin, Nik Nur Fathiha bin Nik Din

Politeknik Kota Bharu, Kelantan, Malaysia
mila@pkb.edu.my , fathiha@pkb.edu.my

Highlights: The use of short video on job interviews is believed to be a useful reference for job applicants to prepare themselves before going for an interview. This short video includes the tips for attending job interviews, the do's and don'ts as well as the samples of answering techniques during the interview supplied with subtitles and interesting images. The language used is easy to understand and the content can help the students to get a clear overview on job interviews. By launching this interactive video to YouTube, it will be the easiest and fastest way for the students to access and understand the topic 'Job Interview'. Moreover, this video is in Malaysian context, attractive, educational and very informative to those who need to prepare themselves for a job interview.

Key words: *job interview, job applicants, useful reference, Malaysian context, attractive, informative.*

Introduction

In polytechnics, students are required to pass 3 Communicative English subjects in order to graduate. During Semester 4, all students will learn Job Hunting Mechanics as one of the topics to be covered in Communicative English 3 course which requires them to undergo a mock job interview as one of the assessments. This is to prepare them for the career opportunity after graduating. Thus, during the teaching and learning process, exposing the students with the materials such as modules and worksheets are not enough in enhancing their speaking skills. They have to be supplied with ample practices which can maximise their skills especially in speaking so that they can shine and be confident when attending job interviews. Moreover, students are keen towards graphics and images which attract their attentions rather than doing exercises on papers. However, tons of videos available online were produced by native speakers and the content was quite hard to be understood by the students. This short video on job interview can help the students to make proper preparation for their mock interview as well as to equip themselves with the necessary skills and knowledge to be adopted when attending their job interviews later.

Content

The short video on job interviews provides interesting and useful information that job applicants should know to excel in job interviews. The sentences used are suitable with their levels and subtitles are provided for their easy reference and understanding. The idea of producing this informative video came from the reality that students could not really respond to job interview questions when mock interviews were done in the classroom. They referred to the YouTube videos but most of them were quite difficult to be understood which resulted in incomprehension towards the video content.

This innovation is a short video on job interviews launched on YouTube on 4 October 2017 and has 1782 viewers as on 14 July 2021. It consists of 4 sections which are introduction, tips, the do's and don'ts and also the frequently asked questions during job interviews with responses. The video was produced in the hope of helping students or graduates who will seek for the job to prepare themselves before being hired. It provides vast information on how to answer questions during job interviews and what to prepare before attending interviews. It can be considered as a quick reference for any job applicants to refer to. This innovation focuses on job applicants in Malaysia as the target audiences because we noticed that most of the videos in YouTube were produced by native speakers and not taken into consideration the challenges that Malaysian students face in terms of language and content.

The importance of the product towards education are It can be considered as a quick reference for the students taking DUE 50032 (Communicative English 3) before attending a mock job interview as one of the assessments under topic Job Hunting Mechanics. It also provides information on the process of job application in Malaysian context and can be a quick reference for graduates before attending a job interview. It provides interesting and useful information that job applicant should know to excel in job interviews and the language used is suitable with their levels and subtitles also provided for their easy reference. The video can become the reference not only for the Polytechnic students taking DUE 50032 but it will be also relevant for all polytechnic alumni even after 4-5 years of their graduation. Using simple graphics and images in the video can attract students' attention and increase their level of understanding towards the topic 'Job Hunting Mechanics' for the DUE 50032 course.

Some of the advantages includes

1. Be More Prepared for Job Interview - The students or job applicants can make preparations and are able to anticipate the interview questions and responses as it is in Malaysian context.
2. Engaging - The students become more engaged with the lesson (Job Hunting Mechanics) as they can refer to the video over and over again. They can play the video repeatedly to gain the understanding of the content.
3. Samples of Questions and Responses- The students or job applicants can refer to the samples provided in the video and practice answering the frequently asked questions as to familiarize themselves with the suitable responses.
4. Increase Understanding - The students or job applicants are able to understand the content easier since it features polytechnics students as the main roles with similar language backgrounds.
5. Improve Language and Communication Skills - The students or job applicants can improve their language proficiency by referring to the language used and how to answer questions during job interviews.
6. Boost Self-confidence – The students or job applicants can build their self-confidence especially in making proper preparation because there are many tips shared in the video as well as the do's and don'ts for job interviews.
7. Relevant and Applicable - The contents are relevant to Malaysian students as it portrays the images and

This short video has been shared and used as teaching material by English lecturers in Politeknik Besut, Terengganu. In Politeknik Kota Bharu, it has also been uploaded in CIDOS 3.5 as a reference under topic Job Hunting Mechanics for the course DUE 50032 (Communicative English 3). In future, we plan to come out with the sequel of this video covering the tips on how to write effective cover letters and how to prepare video resumes. This is to prepare our Polytechnic graduates to possess the right core employability attributes in order to secure employment and remain competitive in the ever challenging workforce sector.

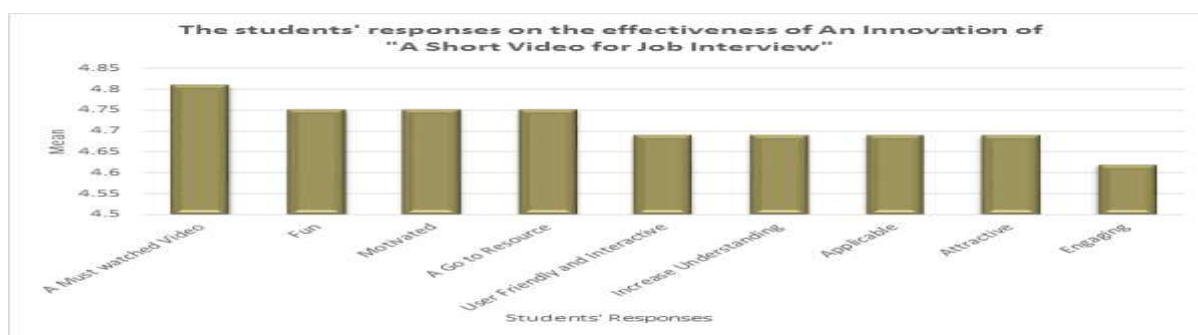

Figure 1: Students' Responses on the Effectiveness of A Short Video on Job interview

Video Link on YouTube : <https://youtu.be/um8CiluyQ10>

Acknowledgement

Special thanks to our Head of General Studies Department, En Roslan bin Mamat for his support and understanding.

References

- Azman, H. (2016). Implementation and challenges of English language education reform in Malaysian primary schools. *3L: Language, Linguistics, Literature*, 22(3).
- Rusli, R., Md Yunus, M., & Hashim, H. (2018). Low speaking proficiency among the Malaysian undergraduates: Why and how. *Persidangan Antarabangsa Sains Sosial dan Kemanusiaan*, 678-689.
- Sherman, J. 2003. *Using Authentic Video in the Language Classroom*. Cambridge University Press. 277pp.
- Ting, S. H., Marzuki, E., Chuah, K. M., Misieng, J., & Jerome, C. (2017). Employers' views on the importance of English proficiency and communication skill for employability in Malaysia. *Indonesian Journal of Applied Linguistics*, 7(2), 315-327.
- Yusof, N., & Jamaluddin, Z. (2017). Graduate employability and preparedness: A case study of University of Malaysia Perlis (UNIMAP), Malaysia. *Geografia-Malaysian Journal of Society and Space*, 11(11).

CLAP SWITCH

Noor Azim Hakimie B Azli

Politeknik Kota Bharu, Kota Bharu, Malaysia
hakimie13@outlook.com

Nurliyana Husna Binti Ramli, Mohd Faizal B Ismail

Politeknik Kota Bharu, Kota Bharu, Malaysia
nurliyana@pkb.edu.my, faizaljmsk@pkb.edu.my

Highlights: "Clap Switch" is a student's Mini Project for course DBS10012-Engineering Science. Its aims to open the minds of students to think creatively and boldly think of new ideas to produce Mini Projects that are appropriate to the content of learning topics in the course of Engineering Science.

Key words: *Clap Switch, electrical, appliances, engineering, science, technologies*

Introduction

Clap Switch is a student's mini project in *Program Mini Project*. It is one of the student's excellence programs that implemented by Jabatan Matematik, Sains dan Komputer (JMSK), Politeknik Kota Bharu. This program can developed students to think more creatively and innovatively. In line with the emphasis on STEM applied in educational institutions, JMSK took an approach to further expand the exposure of technology among students. This *Program Mini Projek* under the supervision of the DBS10012-Engineering Science course can also provide students with an overview of the technology used in today's life.

Along with the passage of time and rapidly evolving technology, electrical appliances created with smart systems are also increasingly advanced in the production market. Technology is also an application of knowledge, science and task tools that can be done with better performance and effectiveness. Modern technology has paved the way for multi-functional devices has also made our lives easier, faster, better, and more fun. Changing technology constitutes an important aspect, both of changes in everyday life and of the environmental impact of everyday-life activities (Inge, 2001).

This is a simple clap switch circuit with high sensitivity. It switches ON/OFF electrical appliances though claps. In the circuit, we will conduct a single relay using clap switch. The circuit can sense the sound clap from a distance of 1- 2 meters. The motivating force behind this design is based on the desire to alleviate the problem faced by the aged and physically challenged persons in trying to control some household appliances.

The main component of this circuit is the Electric Condenser Microphone. This microphone used as a sound sensor and converts sound energy into electrical energy.

Content

For the needs of the students' excellence program, *Program Mini Project* organized by JMSK under the supervision of the DBS10012-Engineering Science course, students are required to produce innovations related to the DBS10012 curriculum. It is to unearth students' talents and hone their interest in engineering science. Students can also be exposed to the latest technology used. The project produced refers to Topic 4: Work, Energy and Power in the DBS10012 syllabus. This main objective this program is to educate students to think more creatively in producing innovations to facilitate daily activities. The idea came from students living in the dormitory turning on and off the lights or fans by only simply clapping.

This Clap Switch is a circuit built with a single relay using clap switch that can send the sound of clap from a distance of 1-2 meters. This circuit is main based on the two IC 741 Op-Amp (amplifier) and CD4017. IC CD4017 which is a CMOS counter / divider IC (as a flip flop to get ON and OFF). This circuit is helpful for you if you wish to ON &OFF the device or electrical appliances through claps without moving from your place. Main components is electric Condenser Microphone used as sound sensor and convert sound energy to electrical Energy. The input component is a transducer that receives clap sound as input and converts it to electrical pulse. Microphones are types of transducers, they convert acoustic energy such as sound signal. The basic idea of clap switch is that the electric microphone picks up the sound of your claps coughs and the sound of that book knocked off the table. It produces a small electrical signal which is amplified by the succeeding transistor stage.

When the first applause signal is given, the signal will be sent through a microphone (pulse / sound wave) amplified by IC 741 (Op Amp) and sent to IC 4017 (flip flop) will cause the indicator light to turn on (ON), at this point it is working. When another second applause signal is given, the signal will be sent through a microphone (pulse / sound wave) amplified by IC 741 (Op Amp) and sent to IC 4017 (flip flop) will cause the indicator light to go off (OFF), when this it is in a non-working state. This process will be repeated until the supply is turned off.

This Clap Switch can turn on or off lights by clapping at a certain distance. It suitable for use anywhere and at all ages. The other use of this circuit is that there is no fear of the electrical shocks as you are not required to touch any of the mechanical switches physically. This kind of system has been helpful of the day to day activity example person can switch on and off the light any place in the room although lying in bed just clapping hands light is activated (T.Jeyaperatha et.al, 2017).

This innovation is created entirely by students with the guidance of lecturers and got the Runner -up in the *Program Mini Projek* innovation competition, JMSK 2021. From this innovation, students can understand more deeply about the topic Work, Energy and Power for the DBS10012 course because they are directly involved in producing this Clap Switch. It can be commercialized as a DIY product (Do It Yourself) because of its low cost and easy installation and can use existing materials/recycled. Can also be applied to other electrical appliances such as fans. This Clap Switch suitable for use in various places such as residential homes, workplaces, in vehicles and so on.

As the conclusion, this Clap Switch is an innovation for traditional equipment in our modern lives. It also able to expose students to technology that can be used in daily life and improve their thinking to innovate. The technology that is used in Clap Switch will beneficial for the *Orang Kurang Upaya (OKU-Cacat Pergerakan)*. It also can save costs because it can use existing/recycled items. It can help in our daily lives to be more effectiveness and move forward. The resulting device is realizable, has good reliability and it's relatively inexpensive.

Acknowledgement

Thank you for all staff at Jabatan Matematik, Sains & Komputer in Politeknik Kota Bharu who are directly or indirectly involved to complete this extended abstract.

References

- Azia Idayu Awang, Azhari Zakaria, Hardyta Bujang Pata, Khairani Yaakub, Noor Affandee Abdul. (2015). Engineering Science, Polytechnic Series, Shah Alam:Oxford Fajar Sdn. Bhd.
- Inge Ropke (2001). New technology in everyday life - Social processes and environmental impact. *Ecological Economics* 38(3):403-422 https://www.researchgate.net/publication/223910326_New_technology_in_everyday_life
Social_processes_and_environmental_impact
- T.Jeyaperatha, Thiruthanigesan Kanagasabai, Nagarathnam Thiruchelvan (2017). Analysing Efficiency and Effectiveness of Clap Switch Mechanism Based on the NE 555 Clap Switch and Arduino Clap Switch. *International Journal of Advance Research in Computer Science and Management* 27(5 4):27-31.
https://www.researchgate.net/publication/321669664_Analysing_Efficiency_and_Effectiveness_of_Clap_Switch_Mechanism_Based_on_the_NE_555_Clap_Switch_and_Arduino_Clap_Switch

SMART DUSTBIN

Muhammad Nabil Najmi Bin Mohd

Razali Politeknik Kota Bharu, Kota Bharu,
Malaysia Nabilkate@gmail.com

Muhammad Arif Farhan Bin Hanipa, Nurliyana Husna Binti Ramli, Nazihah Bt Che Rozan

Politeknik Kota Bharu, Kota Bharu, Malaysia
alienfarhan@gmail.com, nurliyana@pkb.edu.my, nazihah@pkb.edu.my

Highlights: "Smart Dustbin" is a student's Mini Project for course DBS10012-Engineering Science. Its aims to open the minds of students to think creatively and boldly think of new ideas to produce mini projects that are appropriate to the content of learning topics in the course of Engineering Science with minimum cost. This mini project is based on SMD Arduino UNO board and ultrasonic sensor to detect motion near the dustbin with the minimum cost.

Key words: *Smart, Dustbin, Arduino, technologies, waste, mini project*

Introduction

Smart Dustbin is a student's mini project in *Program Mini Project*. It is one of the student's excellence programs that implemented by Jabatan Matematik, Sains dan Komputer (JMSK), Politeknik Kota Bharu. This program can developed students to think more creatively and innovatively. In line with the emphasis on STEM Education applied in educational institutions, JMSK took an approach to further expand the exposure of technology among students. This *Program Mini Project* under the supervision of the DBS10012-Engineering Science course can also provide students with an overview of the technology used in today's life

Nowadays, the rate increasing population in the country has increasing rapidly and also we have increase in garbage which have increased environmental issue. Waste management has been a crucial issue to be considered (U.Nagaraju et.al, 2016). Dustbin is a container which collects garbage's or stores items which recyclable or non- recyclable, decompose and non-decompose. Dustbin and rubbish are common issues we hear about in our daily lives. Dustbin are usually used everywhere. According to Mamta Pandey et. al. (2020), the surrounding of a dustbin is also conducive for increasing the pollution level.

Hence, based on development of technology nowadays, it can be used in ensuring that daily life can be carried out more efficiently. Technologies have positive prominent roles as one of the requirements of this era where it provide services, improve the quality of life since it is a developed culture reflects the culture of the community (Mohammad Bani Younes and Samer Al-Zoubi, 2015).

In line with the fast - moving last two decades, technologies are getting smarter day-by-day so as to clean the environment we are designing a smart dustbin by using Arduino, an ultrasonic sensor which dustbin lid will open when someone comes near at some range than wait for user to put garbage and close it. It is a project that will bring a new and smart way of cleanliness with low cost technology. Therefore it will help to keep cleanliness and hygiene in society (U.Nagaraju et.al, 2016).

For social aspect, it will help to encourage people to use the dustbin and keep the clean environment toward good health and hygiene. It is good for business because it is affordable to many people. This Smart Dustbin will bring something changes in term of cleanliness as well technology.

Content

In line with the Malaysian government's emphasis on IR 4.0 and STEM Education, JMSK took the initiative to provide exposure to students on technology that can be used in daily life. Students are required to produce a product based on the content of the DBS10012 syllabus. So, we produced a project titled "Smart Dustbin" that refers to the Chapter 4: Work, Energy and Power in the syllabus DBS10012-Engineering Science.

This Smart Dustbin is using Arduino code execution. For sensing it used ultrasonic sensor HC-SR04 which will open the lid and wait for few moments. SG90 Plastic Gear Micro Servo Motor is used to open the lid. When Ultrasonic sensor detect any object by using ultrasonic waves for example like hand, Arduino calculates its distance and if it less than a certain predefines value than servo motor gets activate first. Then, lid will open for a given time then it will automatically close. Using this project, the lid of the dustbin stays closed, so that waste is not exposed. It will avoid flies and mosquitos and when you want dispose any waste, it will automatically open the lid if it sense any movement.

The dustbin is able to open the lid with the help of servo motor and sensor whenever it detects motion. The main objective of the project is to design a smart dustbin which help in keeping our environment clean and also eco-friendly. Since the smart dustbin is additionally intriguing and children will make a fun with it so it will help to maintain cleanliness in home. This *Smart Dustbin* will open its lid when someone or object is near at some range then it will wait for given time period than it will close automatically. Then the lid will close when you don't want to use and it will only open when it required. It will overcome the problem of odours and insects that can carry diseases.

Most individuals do not dispose of trash properly into the trash can because it is less comfortable to lift the lid of a relatively dirty trash can. With the Smart Dustbin, it can indirectly solve this problem. Smart Dustbin will open and close the lid without any touch so that the rubbish can be thrown into the rubbish bin. Not only that, this product can be self-assembled by individuals and can be built in a variety of sizes to fit many places. To reduce costs, we can use recycled materials such as plastic buckets and only electronic equipment needs to be purchased.

This product can be commercialized by way of DIY products (Do it Yourself) because the cost of materials is cheap and affordable and easy to install and can use existing materials/recycled. It also created entirely by students with the guidance of a lecturer.

Thus, it will bring drastic changes in term of cleanliness with the help of technology. So, this dustbin will help in maintaining the environment clean with the help of technology and suitable to use by all age group. It also cost effective so everyone can get the benefits from this. With the implementation of this Program Mini Projek, its able to expose students to technology that can be used in daily life and improve their thinking.

From this project, it will help in bringing evolution by technology in term of cleanliness and maintain environment hygiene. The combination of intelligent technologies, smart dustbins are better than traditional garbage dustbin (Mamta Pandey et. al., 2020).

Acknowledgement

Thank you for all staff at Jabatan Matematik, Sains & Komputer in Politeknik Kota Bharu who are directly or indirectly involved to complete this extended abstract.

References

- Mohammad Bani Younes and Samer Al-Zoubi (2015). The Impact of Technologies on Society: A Review. IOSR Journal Of Humanities And Social Science (IOSR-JHSS) Volume 20, Issue 2, Ver. V (Feb. 2015), PP 82-86. Achieved on 12 July 2021. <http://www.iosrjournals.org/iosr-jhss/papers/Vol20-issue2/Version-5/N020258286.pdf>
- Mamta Pandey, Anamika Gowala, MrinalJyoti Goswami, ChinmoySaikia, Dr. Dibyajyoti Bora (2020). Smart Dustbin Using Arduino. International Journal of Scientific Research in Engineering and Management (IJSREM) Vol 04 Issue:08. Achieved on 12 July 2021. https://www.researchgate.net/publication/343530056_SMART_DUSTBIN_USING_ARDUINO
- U. Nagaraju, Ritu Mishra, Chaitanya Kumar, Rajkumar (2016). Smart Dustbin For Economic Growth. VIT University. Achieved on 12 July 2021. https://www.researchgate.net/publication/316700582_SMART_DUSTBIN_FOR_ECONOMIC_GROWTH
- Varun Chaudhary, Rohit Kumar, Anil Rajput, Manvendra Singh, ER. Thakurenndra Singh (2019). Smart Dustbin. International Journal of Scientific Research in Engineering and Technology (IRJET) Vol 06 Issue:05. Achieved on 13 July 2021. <https://www.slideshare.net/irjetjournal/irjet-smart-dustbin>

STEM INTEGRATED LEARNING: MECHANICAL HANDS

Anisah Binti Jawawi

Politeknik Kota Bharu, Kota Bharu, Malaysia
anisah@pkb.edu.my

Wan Siti Rodziah Binti Mohd Nasir, Norainin Binti Ahamed, Muhammad Hazmi Bin Mustafa Bakri, Muhammad Rafiq Amir Bin Rahimin, Muhamad Atiqullah Bin Abdullah, Muhammad Hafizuddin Bin Amran

Politeknik Kota Bharu, Kota Bharu, Malaysia

rodziah@pkb.edu.my, norainin@pkb.edu.my, hazmi2500@gmail.com, Rafiqamir2424@gmail.com,
hafruddin88@gmail.com

Highlights: According to Jamaluddin Muhammad (2014), Malaysia aims for 60 percent of its children and young people to take up STEM education and career for a better future of the country. Students who engage in STEM learning will develop their leadership character and adapting well to the teamwork. Their research and technological skills can be significantly increased together with their communication and presentation skills. Later on, students will evolve a successful shift from the academic environment to the workplace. To this end, Politeknik Kota Bharu takes the full responsibility to enhance the engagements through hands-on activities and scientific innovations. As for Engineering Science course (DBS10012), students are required to infuse science and engineering in their project. For this purpose, they manage to come out with the idea of 'Mechanical Hands' and seems to be feasible and efficient.

Key words: STEM, evolve, hands-on, infuse, feasible.

Introduction

STEM is interpreted as Science, Technology, Engineering, and Mathematics (STEM) was created by the National Science Foundation (NSF). In recent years STEM education has received a great deal of attention (Bybee, 2010). Today's student needs not only skills, but experience that will develop confidence (Al Causey, 2020).

According to Priscilla and Denis (2016), students are continually engaged in rigorous instruction within STEM classrooms and higher order thinking skills are always observed. These students are contrasting from other students because they can work in their knowledge and skills competently. They take their understandings and apply them by creating new solutions to complex problems and proficient in applying, creating, evaluating and critical thinking (Priscilla and Denis, 2016).

Content

1) The Engineering Process

DBS10012 students must infuse the "engineering process" in their STEM projects. Initially the lecturers will guide them on how to incorporate the engineering practice as shown in Figure 1.

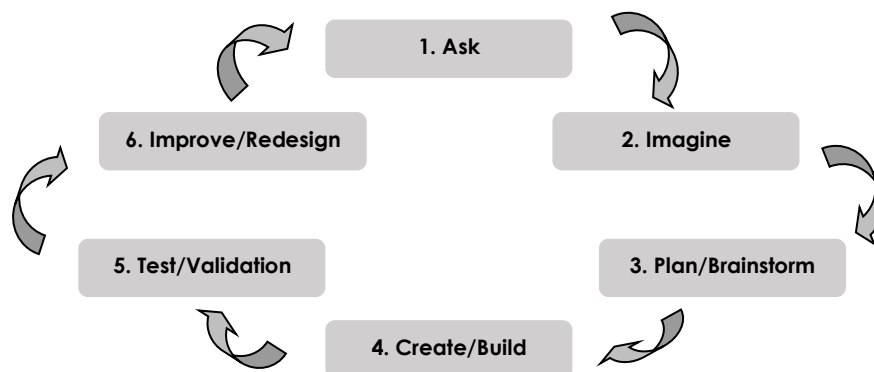

Figure 1: Engineering Process Abstract idea

2) Curriculum Development

STEM integrated curriculum for DBS10012 is mainly to generate:

- A cooperative learning pedagogy to instruct STEM education that line up with the Malaysia Polytechnic philosophy. Cooperative learning is being seriously considered as teaching tool to encourage students to think critically and problem-solve (Gillies, 2014).
- Affordable and uncomplicated hands-on pedagogical aids could stimulates engineering thinking in students.

On top of that, Mechanical Hands project was selected since all the requirement concepts of science and technology are embedded into the project. It combines elements of electrical, mechanical, mechatronics as well as industrial engineering.

At the end of this project, students can absorb and explicate their knowledge of the following topics in DBS10012:

- Simple machines: Levers transform a little effort to a load of force (like a paper cutter or hammer) or transform a small movement to an ample movement (like a broom or baseball bat). Students can recognize the lever systems in the arm and relate the outcome of repositioning the fulcrum or adjusting the length of a section or the string's attachment point.
- Tension and compression: A tension force is one that pulls materials apart from opposite sides. String is adequate to tension forces, making it an excellent control cable. On the other hands, compression is a force that squeezes something together. Cardboard is known as an excellent material in compression, thus turning it into functional lever arm. Students can identify the places on the arm that are in tension and in compression and how the materials were selected to resist these forces.

3) Benefits of Mechanical Hands to Education System

Mechanical Hands project can nurture the cognitive skills among student. For example, students will continue learning from their mistakes. They will discover that errors are not final and might be a starting point of new conclusions and it certainly valuable in the future. Furthermore, by achieving success in a new project field can improves students' self-awareness and self-esteem.

By increasing the use of automation and hi-tech devices, also can stimulate students' imagination and ingenuity. They will become familiar with learning basic programming concepts, a skill that is becoming more and more crucial every year. Also by relating the mathematical or physical intelligence, will influence them to pursue studying these subjects.

Other cognitive skills that are certainly impacted by educational STEM learning are accountability and more optimal growth of spatial perception. Hence, students also will appreciate the teamwork and stimulate socialization and collaboration.

4) Conclusion and Future Work

Further research on analyses of learning processes in individual and group/social contexts should be pursued using strong theoretical frameworks as a way of enhancing our conceptual foundations for computer-based STEM education, and providing a more coherent framework to guide research-based educational applications (Ying-Tien, O. Roger, 2015). Above all, students need to comprehend and enjoy engineering and at the same time lecturers will develop similarly rich learning atmosphere for Malaysia polytechnics. Creating such atmosphere entails creating significant formal professional development programs and variants of opportunities for lecturers to discover, as well as imposing policies and practices in polytechnic that can nurture learning philosophy for lecturers and students.

Malaysia polytechnics and administrators should develop a broad conceptualization of lecturer opportunities as well as how much associated costs and time are spent. Throughout this process, lecturers will be given chances to learn about other teaching perspectives, engineering elements, scientific practices and pedagogical knowledge. While determine the costs involved, polytechnic should evaluate both conventional professional development time and other aids for learning, such as curriculum, teacher evaluation, and student accountability.

Finally lecturers and students should be in position to scrutinize the entire prospects of new formats and media when appropriate, hence encounter the new perception challenges of science teaching and learning.

References

- Bybee, R. W. (2010). Advancing STEM Education: A 2020 Vision. *Technology and Engineering Teacher*, 70, 30-35.
- David W. White (2014). What is STEM Education and Why is it Important? Retrieved from <http://www.fate1.org/journals/2014/white.pdf>
- Gillies, R. (2014). Cooperative Learning: Developments in Research. *International Journal of Educational Psychology*, 3(2), 125-140.
- I Gusti Putu Asto Buditjahjanto, Pramudya Ardi, Munoto Munoto, Muchlas Samani (2020). Evaluating and Analyzing of RoboticArm as Learning Media Based on Partial Least Square Method. Retrieved from https://www.temjournal.com/content/92/TEMJournalMay2020_672_679.pdf
- Jamaluddin Muhammad. (2014). Malaysia Aims for 60 Per Cent of Children to Take up STEM Education, Retrieved from http://education.bernama.com/index.php?sid=news_content&id=1070878
- Priscilla Lo Khai Chien, Denis Andrew D. Lajum (2016). The Effectiveness of Science, Technology, Engineering and Mathematics (STEM) Learning Approach Among Secondary School Students. Retrieved from https://www.researchgate.net/publication/310651088_The_effectiveness_of_science_technology_engineering_and_maths_STEM_learning_approach_among_secondary_school_students
- Robyn Gillies (2014). Cooperative Learning: Developments in Research. Retrieved from https://www.researchgate.net/publication/306128320_Cooperative_learning_Developments_in_research
- Saeedeh Ziaeeefard, Nina Mahmoudian, Michele Miller, Mo Rastgar (2016). Engaging Students in STEM Learning Through Co-Robotic Hands-on Activities. Retrieved from https://www.researchgate.net/publication/302985244_Engaging_Students_in_STEM_Learning_through_Corobotic_Hands-on_Activities_Evaluation
- Suzanne Wilson, Heidi Schweingruber, Natalie Nielsen (2015). Science Teachers' Learning: Enhancing Opportunities, Creating Supportive Contexts. Retrieved from <https://www.nap.edu/read/21836/chapter/1>
- Ying-Tien Wu, O. Roger Anderson (2015). Technology-Enhanced Stem (Science, Technology, Engineering, And Mathematics) Education. Retrieved from <https://link.springer.com/article/10.1007/s40692-015-0041-2>

DEAR SIR: SMART INTERACTIVE RESEARCH TOOL FOR STUDENTS

Nadia Hanum Binti Amiruddin

Faculty of Entrepreneurship & Business, Universiti Malaysia Kelantan, Malaysia
nhanum@umk.edu.my

**Norzianis Binti Rezali @ Abdul Sukor¹, Sulaiman Bin Mohammed Khalid², Siti Daleela Binti Mohd Wahid³,
Norraidah Binti Abu Hasan⁴, Ahmad Sapuan Bin Hasan⁵**

¹Commerce Department, Politeknik Tuanku Syed Sirajuddin, Perlis, Malaysia

²Tourism and Hospitality Department, Politeknik Muadzam Shah, Pahang, Malaysia

³Faculty of Business and Management, Universiti Teknologi MARA, Melaka, Malaysia

⁴Faculty of Administrative Science and Policy Studies, Universiti Teknologi MARA, Negeri Sembilan, Malaysia

⁵Mechanical Department, Politeknik Kuching Sarawak, Malaysia

norzianis_rezali@ptss.edu.my, sulaiman@pms.edu.my, sitid365@uitm.edu.my,

norraidah@uitm.edu.my, sapuan@poliku.edu.my

Highlights: The rising of digital technological advancement in the Industrial Revolution 4.0 (IR4.0) era has consistently affected the teaching and learning (T&L) environment. Unlike traditional method of learning, e-Learning makes learning interactive, simpler, combined theoretical and practical, and more effective. Today's learners want relevant, mobile, self-paced, and personalized content. Following the similar concept, DEAR SIR was introduced to create more excitement that consequently able to generate quality graduate through scientific mindsets.

Key words: research tool, smart interactive mobile apps, research student, advanced technology

Introduction

DEAR SIR is a mobile application which acted as a research alternative tool to ensure T&L more interesting and interactive. We developed DEAR SIR application with an objective to assist university's students and amateur researchers to understand the basic idea of research processes. Even though, there are numerous of research aid available in the market, but none of them practically guide the student to comprehend how to identify and align the research issues, objectives, questions, hypotheses, and framework development. Surprisingly, very limited comprehensive research application tool can be obtained to lead us on how to classify the most crucial elements of research. Therefore, we develop DEAR SIR research tool. Evidently, the Dear SIR utilized the concept of "finding pieces of the puzzle and putting it together" to understand the complex research process to assist students and amateur researchers.

Content

1. Description of innovation / product development / design / process.

The DEAR SIR is a mobile application that used to ease students, lecturers, and amateur researcher to understand the concept of research elements. It is user friendly, systematic, structured, feasible and practical to be implemented to enhance our target group understanding and falling for research. DEAR SIR is comprehensive tool to guide users the important elements of research when reading a journal article. Currently, we have ran a pilot study to test it applicability among 8 postgraduate students at Universiti Teknologi MARA, Melaka.

2. What is the context or background of the innovation / product development / design / process?

Malaysia is guide us on how to "pull-out and write" the important element when we read an article. Apparently, the Dear SIR utilized the concept of "finding pieces of the puzzle and putting it together" to understand the complex research process to assist students and amateur researchers.

Why are they important to education? DEAR SIR is very significance because of several reasons:

- Support the Malaysia Education Blueprint 2015-2025 (Higher Education) – This innovation directly support shift 1 (holistic entrepreneurial balanced graduate), shift 9 (globalised online learning) and shift 10 (transformed higher education delivery)
- Cultivate Interest to Learn Research - DEAR SIR is an interactive research tool that able to capture student's attention and curiosity that subsequently eliminate the study difficulties. We developed this application with interesting features including colorful background, large font, user-friendly and understandable. Indirectly, it helps all education institutions to produce more researchers.
- Increase Number of Graduate on Time (GoT) - We believe if the students downloaded DEAR SIR tool, at least 1% of students will graduate on time. It is university's requirement to increase more GoT students, decrease dropout rates and achieve its organisational performance excellence.

- d) Increase Accessibility and Flexibility – We developed DEAR SIR to allow the students to have easy, functional access to information that they need in real-time and are optimized for hands on interaction.
- e) Enhance the Student's Outcomes and Productivity – Learning research require patience and passion. If we can offer the best teaching aid product for them, it will enhance their interest and productivity. The target group will be able to understand the basic knowledge of the research elements and expedite the learning processes.

3. Advantages of innovation / product development / design / process towards education and community.

- a) Education
 - i. Achieve Malaysia education blueprint 2015-2025 (higher education) aspirations
 - ii. Increase university's MyRA score – Citation and university education service quality delivery
 - iii. Enrich interactive learning and transform from the traditional to modern education environment –
 - iv. Research methodology
 - v. Enhance level of understanding on research processes
- b) Community
 - i. Create the scientific thinking community
 - ii. Create ICT literacy community
 - iii. Spurred creative and innovative culture among academics' community
 - iv. Greater access to quality education

4. Commercial value in terms of marketability or profitability of the innovation / product development / design / process.

In apps purchase – For example, subscription and freemium model

- i. Freemium Model: DEAR SIR will have two types of features: Basic ones that are free to use, and premium ones that the user needs to pay for. The goal is to give a user a possibility to try out and enjoy all the premium features hoping they will further pay for upgrading.
- ii. Subscriptions: We have discussed with Dr Anita Adnan, the admin of Doctorate Support Group (DSG), she mentioned DSG used to subscribe any requested applications for students. subscribed, a user will be charged a certain amount of money on a regular basis – monthly, quarterly, yearly. It is also common to provide a trial period before getting users to subscribe.

Acknowledgement

We are grateful for the teamwork. All members play significant roles on the development of this product.

References

- Annapurna, S., Pavan Teja, K.V.S., & Satyanarayana Murty, Y. (2016). A comparative study on mobile platforms (Android vs. iOS). *International Journal of Advanced Research in Computer Engineering & Technology*, 5(3), 547- 553.
- Baktha, K. (2017). Mobile application development: All the steps and guidelines for successful creation on mobile apps. *International Journal of Computer Science and Mobile Computing*, 6(9), 15-20.
- Balasi, R.K., & Singh, J. (2016). Systematic review on mobile operating system. *International Journal of Engineering and Computer Science*, 5(12), 19565-19567.

READ-A-LOT!: READEA

Fatin Sabrina Abdul Sukor

UiTM Cawangan Pahang Kampus Jengka, Pahang, Malaysia
fatinsabrina@uitm.edu.my

Norhidayah Binti Md Yusof¹, Nor Fazura Md Zulkifle², Nur Baiti Binti Ismail Shauki³

¹UiTM Cawangan Pahang Kampus Jengka, Pahang, Malaysia,

²Universiti Malaysia Kelantan, Malaysia,

³Universiti Utara Malaysia, Sintok, Kedah, Malaysia

norhidayahmy@uitm.edu.my, Fazura.mz@umk.edu.my, baitishauki@gmail.com

Highlights: *Readea* is a fun activity that in be done in 10 minutes, every day. Language learners are free to use any reading materials they prefer, for as long as they are able to read for a minimum 10 minutes a day. *Readea* is a process to increase students' vocabulary and a way to master their grammar skills along the way.

Key words: *reading, English competency, language learning*

Description, Design And Process

Reading has always been vital in empowering language learning. It is a gateway in mastering the language itself. *Readea* is a fun activity that in be done in 10 minutes, every day. Language learners are free to use any reading materials they prefer, for as long as they are able to read for a minimum 10 minutes a day. *Readea* is a process to increase students' vocabulary and a way to master their grammar skills along the way. This process should continue for a minimum of 3 months on order to see positive results from language learners. Language learners are encouraged to continue *Readea* for a longer period of time.

Background

In acquiring knowledge, nobody can escape from reading. Reading literacy has increase decade to decade as everyone knows that with knowledge, comes power. There are even numerous research on ways to overcome illiteracy in schools. Thus, to convey an information, mastering language is crucial. Reading is indeed a way to familiarize the language as it increases a person's vocabulary. Almost everyone knows about that fact. Then again, it is disappointing that generally, a Malaysian reads an average of two books a year (Cheah, 2020). By having good reading practice, language learning can excel their language skills as well as knowledge in other fields.

Importance

The process in *Readea* is important in order to cultivate better reading habits among language learners. A good reading habit is an important tool for the development of personalities and mental capacities (Abidin et al., 2011). Language learners are able to increase their language proficiency as they gain other information during this process. This is supported by Ariffin (2010) who mentioned that knowledge gained will attract people to read and to increase their knowledge. Indirectly, *Readea* is able to solve most problems among language learners in motivating them, inspire ideas and even encouraging them to learn better, by just reading 10 minutes a day. It will be fun for both educators and language learners as *Readea* does not take a lot of time. The only thing it takes is just consistency. With consistency, the potential of *Readea* can be fully utilised.

Advantages

To date, the biggest advantage of this process is language learners are able better results in their English subject. For example, language learners are able to get B+ in their English subject compared to C or D grade in the past. Constant reading will help students in their academic achievement (Subashini & Balakrishnan, 2013). Due to this fact, language learners are more motivated in their learning as they know, when they continue to conduct *Readea*, they will gain other benefits such as excel in their other subjects. Overall, this process is able to cultivate better learning abilities to everyone. In the future, *Readea* might be able to boost reading habits among Malaysians. This may be in a stronger position to encourage the development of a reading habit that will empower young people (Hopper, 2005).

Marketability

Readea can be commercialized by using these steps:

1. Use only interesting reading materials
2. Introduce the reading materials to language learners

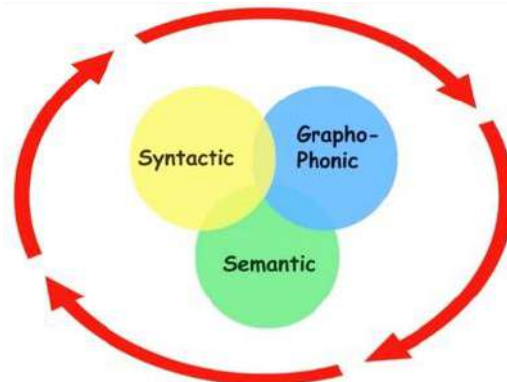

Figure 1: McCollum Reading Theory

3. Let the language learners read the materials 10 minutes a day, every day until they finished with their reading.
4. Use another reading material and they need to continue for a minimum of three months.

This process is marketable in training potential clients. If the clients are happy with the results, only then the profit can be gained.

References

- Abidin, M. J. Z., Pour Mohammadi, M., & Ooi, C.L. (2011). The Reading Habits Of Malaysian Chinese University Students. *Journal Of Studies In Education*, 1(9), <http://Dx.Doi.Org/10.5296/Jse.V1i1.1037>
- Ariffin, I, A, M. (2010). *Tabiat Membaca Di Kalangan Pelajar Kemahiran Hidup Di Universiti*. (Doctoral Dissertation, Universiti Pendidikan Sultan Idris). Malaysia Dokumen. <https://Fdokumen.Site/Document/Tabiat-Membaca-Di-Kalangan-Masyarakat-Malaysia.Html>
- Bell, S. M., & Mccollum, R. S. (2016). *Handbook Of Reading Assessment* (1st Ed.). Routledge.
- Cheah, C.H. (2020, March 15). Pick Up The Reading Habit. *News Straights Times*. Retrieved From <https://www.nst.com.my/Opinion/Letters/2020/03/574673/Pick-Reading-Habit>
- Hopper, R. (2005). What Are Teenagers Reading? Adolescent Fiction Reading Habits And Reading Choices. *Literacy*, UKLA, 39(3), 113-120. <https://doi-org.ezaccess.library.uim.edu.my/10.1111/j.1467-9345.2005.00409.x>
- Subashini, A., & Balakrishnan, M. (2013). Reading Habit And Attitude Among Malaysian Polytechnic Students. *International Online Journal Of Educational Sciences*, 5(1), 32-41. https://www.researchgate.net/publication/284003779_Reading_Habit_And_Attitude_Among_Malaysian_Polytechnic_Students

AN INNOVATION ON ENHANCING ORAL PRESENTATION SKILLS THROUGH SELF-ASSESSMENT OF VIDEO RECORDING AND ORAL PRESENTATION TEMPLATE

Roslan bin Mamat

Politeknik Kota Bharu, Ketereh, Malaysia
roslanmamat@pkb.edu.my

Yuzaimi binti Yazid, W. Farhana binti W. Halim

Politeknik Kota Bharu, Ketereh, Malaysia
yuzaimi@pkb.edu.my , farhana@pkb.edu.my

Highlights: The central concern of this innovation is to make students realize that a good presentation doesn't just only mean presenting a good material, but also needs appropriate framework to make sure the presentation is coherent, effective and interesting. The tools used are; an oral presentation template to improve the coherence of the content and self-assessment of video recording to improve the delivery skills.

Key words: *oral presentation, template, self-assessment, video recording*

Introduction

Malaysian Polytechnic is an institution that caters for fulfilling the need of semi-professional workers in Malaysia. One of the requirements to complete the whole program in polytechnic is English subject. They have to at least pass three courses of Communicative English in their first, third and fourth semester.

Since it is communicative English, one of the compulsory assessments is oral presentation. For the purpose of this innovation, two students of low proficiency level were chosen. They were able to understand instructions given in English and present their topic of interest. However, they were unable to present their topic according to the appropriate framework of an oral presentation. What they did was, they looked for the content on the internet and memorized it. They then presented it without taking into account the correct flow of an oral presentation. As a result, the students failed in the assessment.

This unfortunate event had led to this innovation involving an oral presentation template and self-assessment of video recording (using an observation checklist) in order to improve oral presentation marks especially in coherence and delivery skills

Content

1. Description of the innovation

In the beginning, the students were given the oral presentation question. The question was about presenting their topic of interest. Together with the question, they were also supplied with rubrics. They had to work in pairs. After one week, they presented their topics and this presentation was recorded.

There were two failures in the class. After looking through their marks for each criteria, it was found out that they could have scored more if they have improved in their delivery and coherence in content.

The students were evaluated on four criteria, namely; language, content, visual aid and delivery. Since this presentation was done in pairs, they shared the same marks for content. This was because the first presenter dealt with introduction, first point and conclusion, while the second presenter dealt with second point and third point.

The students were called back. Their presentation video was transferred to their smart phones and they were also given an observation checklist. Next, they were asked to watch the video and personally assess their presentation by checking on the observation checklist. This checklist was meant to help them evaluate their own performance. They were also given an oral presentation template as a guidance for them in making sure the content had a good flow and coherence.

They had successfully identified the areas that they should have improved in the delivery. They also could re-organize their content by fitting it in the oral presentation template. Through this, they could improve in the coherence of the content and their delivery skills.

The improvement of marks could be seen in the result. Both of the students failed in their first presentation. However, after they self-assessed their video recording and filled in the oral presentation template, they managed to improve their marks in the second presentation. They eventually passed the oral presentation assessment after benefiting the innovation.

2. The context or background of the innovation

Students with low proficiency level need more attention and guidance from the teacher. They need to be taught using differentiation approach whereby the support used must be different and suitable with their proficiency. The approach used must also be different in order to achieve the objectives of the lesson. Oral presentation is one of the major and important components in learning English language. It covers a wide area of evaluation ranging from language, content and delivery. Thus, in order to meet the need of differentiation approach in supporting the students with low proficiency in English language, this innovation comes to the rescue. Oral presentation template and self-assessment of video recording are beneficial tools in helping the students meet the requirements of a good oral presentation. As a result, the students are at a better position of scoring more marks in oral presentation assessment.

3. The importance of this innovation to education

This innovation is important for our education system especially for those who practice differentiation in the classroom. It is capable to attend to the learning needs of a particular student or a small group of students rather than the more typical pattern of teaching the class as though all individuals in it are basically alike. As a result, the achievement of the maximum student growth and individual success can be guaranteed which eventually benefits both teachers and students.

4. Advantages of the innovation towards education and community

This innovation is very beneficial for both teachers and students. It is important for teachers in meeting the needs of students with low proficiency to score in oral presentation assessment. In addition, it is a good approach to diversify the teaching strategies so that all students with all proficiency levels could achieve the lesson objectives. This innovation can also be practiced not just for English subject, but also for other subjects that involve oral presentation. It is easy to be manipulated according to the requirements of the subject.

5. Commercial value in terms of marketability or profitability of the innovation

This innovation is marketable to all students of all levels. Even teachers teaching primary students can practice this innovation in order to make the teaching more fun and meaningful, what more the teachers teaching students at tertiary level. The approach used is very user-friendly and adjustable according to the needs of the subjects. The most important thing is the aim of this innovation in helping students score and do well in any oral presentations.

References

- Kirgoz, Y. (2011). A Blended Learning Study on Implementing Video Recorded Speaking Tasks in Task-Based Classroom Instruction. The Turkish Online Journal of Educational Technology, Volume 10, Issue 4, 1-11.
- Orlova, N. (2009). Video Recording as a Stimulus for Reflection in Pre-Service EFL. Number 2, English Teaching Forum, 30-34.

#SOFTWARETHESES

A FASTER WAY TO FIND RESEARCH GAPS AND COLLECT CONTENTS FOR CHAPTER 1,2,3,4,5

Ahmad Humaizi Hilmi

Faculty of Mechanical Engineering Technology (UniMAP), Kangar, Malaysia
humaizi@unimap.edu.my

Ahmad Zaim Hilmi

Jameela Sdn Bhd, Penang, Malaysia
ahmadzaimhilmi@gmail.com

Highlights: Postgraduate and undergraduate students must submit a thesis to graduate. Students must identify research gaps, however they lose focus and are unable to retrieve facts that can aid in research. To choose the suitable approaches, students must comprehend prior research methods and then devise their own. Most students spend their study years doing experiments and writing at the conclusion. Students have ideas for writing but struggle to put them into words. There is a need for a structured process for students to find research gaps and compose thesis material. Softwaretheses aids in identifying research gaps, methodology, and material for theses.

Key words: *Research Gaps, List of Methodologies, Theses contents*

Introduction

Students from all fields of study, from undergraduate to masters and PhD students are required to write a thesis to complete their study. For undergraduate, it is known as Final Year Report. For Masters and PhD, it is known as dissertation for mixed mode course and theses for full time research. Common problem for all students is to firstly to find research gap.

Typically, a student must read abundance of journals to extract information. Almost all the time they lose focus and not successful to extract information that can help them finding research gap. Research gap is written in Chapter 1: Introduction. Then when they find their research gap, students must write literature review. To write literature review, students must collect relevant information from various journals. Always all the time, students have idea to write, but have difficulties in writing it in theses. This is because there is too much information to write, and they seldom disorganize to write it. Literature review is written in Chapter 2: Literature review. After reading various journals, students are expected to write their own methodology. To choose the right methodologies, it needs understanding of various methods written by previous researchers. It may be concerning certain experiments, equations, algorithms, case study, interviews and others. Students find it hard to place the first method to second method to another. They also have problems in relating those methodologies to their own research. Methodology is written in Chapter 3: Methodology. Typically, the university gives them one semester (6 months) for literature study. Hoping by the end of semester the students will produce Chapter 1, 2 and 3. Usually majority of students delay it to the end of their study to write Chapter 1, 2 and 3. For Chapter 4: Results and discussion, students will write their results and give discussions on it. It always happens that students have idea things to write but have it is hard for them to translate it in written form. In other words, students find it difficult to write a proper discussion. The same goes for Chapter 5: Conclusion. Students have all the data, but it is hard for them to write proper conclusion. Generally, it takes above average students to graduate on time. For most students, they must extend their study just to write their report. Meaning they spend their study years to do experiments and leave their writing at the end of their study. In the end, students find it difficult to recollect their records and write them in proper ways.

Therefore, there is a need for a proper structural method so that students can find research gap and write contents for theses in proper way. This method will fasten the writing time and make them understand their findings in a proper way. Hence, the author and his brother had developed a software name as #Softwaretheses. #Softwaretheses can analyse unlimited number of journals abstracts and journal contents. For those who are still finding the research gaps and list of methodologies, they just download unlimited number of journal abstracts related and just email to the system. For those who are writing Chapter 2,3,4 and 5, they just compile all journal contents that are most related to their research and send it to the system. #softwaretheses operates by analysing the contents given and extracting sentences and keywords that the user input. Users will be provided with video guidelines in Malay language and English language. Upon understanding the tips given in the video, users are expected to complete the theses manuscript in short time. As their research progresses, users can improve the contents in the manuscript. To use #softwaretheses, users can contact the author for registration to the system.

For summary, #SoftwareTheses can help collecting contents for

1. Finding research gap
2. Finding contents for Chapter 1,2,3,4 and 5
3. Finding list of methodologies
4. Contents for journals
5. Contents for writing research grants

Acknowledgement

The author would like to thank his brother Ahmad Zaim Hilmi for doing all the programming for #Softwaretheses. The author would also like to thank UniMAP for giving opportunity in teaching and learning. The experiences in teaching and learning resulted in completion of #softwaretheses

References

Humaizi, Zaim (2021), Softwaretheses [Version 2021], [Email version].

YOU ARE JACK! - ENHANCING ENGLISH LITERACY THROUGH FAIRYTALE ADVENTURE

Syed Muhammad Adam Syed Najib

Centre for Foundation & General Studies, Universiti Selangor, Bestari Jaya, 45600 Selangor, Malaysia
syadam.sn@gmail.com

**Farah Diyana Wan Iskandar Shah, Umami Rumaisyah Masdino, Muhammad Shafiq Muhammad Nor,
Muhammad Al-Ameen Amir Fauwaz, Ai'syah Abd Mutalib, Nurshahirah Azman, Ann Sofee Razali, Mirza
Madiyah Zainal, Hazeeq Hazwan Azman**

Centre for Foundation & General Studies, Universiti Selangor, Bestari Jaya, 45600 Selangor, Malaysia
farahdiyanaa02@gmail.com, rumaisyahsyar@gmail.com, ariezschafer@gmail.com,
muhammadalameen55@gmail.com, m_aisyah@unisel.edu.my, nurshahirah@unisel.edu.my,
annsofee@unisel.edu.my, mirza@unisel.edu.my, hazeeq87@unisel.edu.my

Highlights: "You Are Jack!" is a fairytale that dictates the story of a boy who woke up in the jungle and the journey of him making his way out. This English literacy product incorporates STEM skills such as creativity, logic and critical thinking. The integration would bring a new flair to elementary education in Malaysia, packing a new and fun learning experience for students aged between 9-12. Seeing that students nowadays are surrounded by video games and entertainment that separate them from reality, this game set helps them entertain themselves while helping them catch up with certain aspects of education.

Keywords: *storybook, learning aid, English literacy, STEM, education*

Introduction

Game-based learning is one of the interesting approaches that motivate learners to grasp English literacy and STEM skills better. Thus, "You Are Jack!" is designed to enhance English literacy and foster STEM skills targeted towards young learners. With the elements of storytelling, problem-solving and imaginative adventures as the foundation of the whole game, this product elicits critical thinking skills among players, which is one of the important cognitive elements to be proficient in when it comes to acquiring STEM skills. It also incorporates the elements of creativity, communication and collaboration which simultaneously enhance learners' communication and English language skills which go in sync with the need to develop STEM skills within these young learners.

Product Description

The gamified fairytale "You Are Jack!" will be marketed online for customers to print it out themselves upon purchasing. The first document is called 'You Are Jack: Jack' while the second is 'You Are Jack: The Guides.' This game requires at least two players; Player Jack and The Guide.

The whole game is based on the backstory of Jack who had an adventurous dream in his sleep, but then woke up alone in a dark, haunting forest. Jack then had to choose a path (out of three paths provided) to go home. Despite his desperation to return to his hometown, Thaw, he could not help but encounter various obstacles which he needs to overcome.

The paths presented in the story are the three varieties of routes that players can choose from. This is developed to encourage users to play more than once, with multiple outcomes. The obstacles integrated into this book are elaborated as follows:

Stage 1: Charade

Jack will only be able to cross a river if he manages to succeed in the charade games by guessing what Kiev (another character) is imitating.

Stage 2: Bingo 'o' riddles

Jack will need to solve a riddle and play a bingo game to advance.

Stage 3: The Maze

Guided by the Guardian of Thaw, Jack will be navigating the maze to get to Thaw.

Stage 4: The Crossword

Upon exiting The Maze, Jack will need to prove himself as a Thawrian by solving a crossword puzzle.

Once Jack has completed all four stages, Jack will meet his mother at home and the story comes to an end.

Product Benefits

As this game-based learning aid is packed with challenges, it will equip players with outcomes where their STEM skills are enhanced. The various stages of the game are integrated with 21st century required skills including cognitive, intrapersonal and interpersonal skills.

In general, the fairytale is aimed to increase players English language comprehension skills and grammar awareness. Throughout playing this game, they are introduced to many English vocabularies and it will help young learners improve their understanding of a certain word. It is crucial that young learners are exposed to English vocabularies since it is a critical part of learning a language (Sulistianingsih et al., 2019). By engaging in this fairytale, players are also able to increase their reading and listening abilities as they have to work as a team. This produces great communication skills and teamwork among the players, which is a sought-after skill in quality human resources within this 21st century (Rustaman, Afianti & Maryati, 2018).

The integrated obstacle, for instance, the Riddles and Crosswords, leads players to think creatively and concurrently, it increases their general knowledge which enables them to apply logical thinking. While for Bingo and Maze, players will get a better understanding of directions and they will have to exhibit how to plan strategically. This is not limited to those who just play as Jack but also players that act as The Guides since they will expand their capabilities to listen well and to be more attentive to the players that they are guiding. Thus, these games are able to enhance many aspects of improving the English language.

Conclusion

Overall, the integration of STEM elements into English literacy education will benefit younger learners. This product has commercial potential, marketed towards teachers, parents and also the tech-savvy younger generation itself. Cognitive skills, interpersonal skills as well as intrapersonal skills are some of the important elements included within STEM skills which would foster them into using higher-order thinking skills (HOTS) as well as applying innovative approaches in solving problems while working effectively in a team through fruitful communication. This game-based learning aid "You Are Jack" is a suitable medium in inducing interest in learning English while incorporating all these skills.

References

- Rustaman, N. Y., Afianti, E., & Maryati, S. (2018, May). STEM based learning to facilitate middle school students' conceptual change, creativity and collaboration in organization of living system topics. *Journal of Physics: Conference Series*, 1013(1), 012021
- Sulistianingsih, E., Febriani, R., & Pradjarto, J. (2019). The effect of interactive board games (IBG) on vocabulary achievement. *Langkawi: Journal of The Association for Arabic and English*, 5(2), 127-139.

ELECTRICAL ENGINEERING MATHEMATICS APP

Muhammad Shahrizal Bin Shahrimy
Politeknik Kota Bharu, Kota Bharu, Kelantan
Shahrizal0923@gmail.com

Wan Izyani Binti Wan Jusoh, Rozaimah Binti Mustapa
Politeknik Kota Bharu, Kota Bharu, Kelantan
izyani@pkb.edu.my, rozaimah@pkb.edu.my

Highlights: Electrical Engineering Mathematics App is an innovation designed to benefit not only third-semester students who are taking Electrical Engineering Mathematics course, but also the lecturers who are involved in this course. This application uses a mobile phone as a medium. It includes four main modules; the Student Study Guide, Notes, Past Years Questions, and Videos of Teaching and Learning. Structured planning has been made so that this application is in line with the syllabus. Users can use this application by just downloading it to their mobile phones. No cost is required in producing this application.

Key words: *application, mobile phone, syllabus, module, user friendly, access*

Introduction

Electrical Engineering Math App is an application that can be used through smartphones. It is specially designated to provide a learning experience through the concept of mobile learning. Krull and Duarte (2017) stated that "the potential and use of mobile devices in higher education has been a key issue for educational research and practice since the widespread adoption of these devices". Mobile learning means different things to different group across higher education (Leiberman, 2019).

Innovation Objectives

1. To administer online studies and distance education
2. To facilitate the preparation of teaching and learning by sharing online materials easily, quickly, and effectively
 - To practice diversity in teaching methods
3. To increase lecturers' productivity with the knowledge sharing
4. To cultivate innovation and collaboration among students and lecturers

Background of the study

This innovation is developed by Mr. Mohd Shahrizal Shahrimy with the assistance of Mrs. Wan Izyani Binti Wan Jusoh and Mrs. Rozaimah Mustapa. An online application called Andromo is used to design the Electrical Engineering Math App. The application's content is in line with DBM30043 syllabus (Electrical Engineering Mathematics). The development of this application is also on a par with the KPIs of the Department of Science and Computer Mathematics, which is to develop and use mobile applications as a catalyst in the teaching and learning process.

The Electrical Engineering Math App is developed to overcome complaints made by students who were unable to acquire the teaching materials given by the lecturers since they do not have access to laptops. Brainstorming sessions were held between the lecturers and students to draft an application that can be designed, its application functions, as well as its interfaces in order to produce a user-friendly application. According to (Abdalha, Muasaad, Aldelkader and Capretz (2014), mobile learning application must be easy to use, learnable, understandable, and attractive as well as provide an enjoyable experience for users. A total of one month has been taken to produce this application.

The application consists of 8 main menus that are as follows.

Main Menu 1 : SSG
Overview of DBM30043 Course

Main Menu 2 : CHAPTER 1 : STATISTICS
Displays notes for chapter 1

Main Menu 3 : CHAPTER 2 : NUMERICAL METHOD
Displays notes for chapter 2

Main Menu 4 : CHAPTER 1 : PROBABILITY
Displays notes for chapter 1

Main Menu 5 : CHAPTER 3 : ORDINARY DIFFERENTIAL EQUATION
Displays notes for chapter

Main Menu 6 : CHAPTER 4 : LAPLACE TRANSFORM
Display notes for Laplace Transform

Main Menu 7 : PAST YEARS QUESTION
Displays sets of final exam questions

Main Menu 8 : VIDEO PnP
Provides collections of teaching and learning videos based on DBM30043 course

The Rationalization of Innovation

The Electrical Engineering Math Apps is designed for students who enrol in the Electrical Engineering Mathematics (DBM30043) course. It fits the syllabus and can replace the physical notes that the students often use in the classroom. This app suits students well since the students can download the app for offline access anytime anywhere. Furthermore, it also solves the problem of some students who do not have access to laptops and computers at home. Another rationale for developing this easily accessible, interactive application would be to increase the students' level of interest in mathematical subjects.

Lecturers can use this Electrical Engineering Math App as one of the teaching tools; it is also adjusted to the new normal of learning and teaching. According to the research of Biswas & Roy (2020) the findings demonstrate that mobile learning is a useful tool for this pandemic time where student can learn from outside of classroom or participate in class from everywhere

The Innovation's Impacts And Efficiencies

Impacts on Polytechnic Kota Bharu and the Department of Science and Computer Mathematics

1. To assists polytechnic Kota Bharu in producing creative and high potential innovation materials • To increase polytechnic Kota Bharu's teaching aids
2. To assist PKB and JMSK in achieving KPIs through developing mobile applications as catalysts in the teaching and learning process

Impacts on Lecturers

1. To assist lecturers in implementing more effective teaching and learning process
2. To enhance lecturers' satisfaction in ensuring that the teaching and learning can be delivered effectively • To improve the quality and the effectiveness in teaching and learning

Impacts on Students

1. To provide a mobile learning experience for students
2. To increase the spirit of learning among students with the help of interesting and interactive applications • To help students overcoming their learning barriers

Commercial Value in Electrical Engineering Math App

1. It can be access anywhere and everywhere
2. This app is not only limited for Polytechnic Kota Bharu students as the contents of the app are suitable for everyone who is interested in the Engineering Mathematics subject
3. The downloaded notes can be used offline

Suggestions For Improvements

Improvements will be made on the Electrical Engineering Math App's contents from time to time based on the contents' needs that are in line with the latest curriculum. In the future, Student Assessment Menu will be added to the app. This menu will serve as a platform for students to submit all assignments given by the lecturers.

References

- Ali, A., Alrasheedi, M., Ouda, A., & Capretz, L. F. (2015). A study of the interface usability issues of mobile learning applications for smart phones from the users perspective. arXiv preprint arXiv:1501.01875.
- Biswas, B., Roy, S. K., & Roy, F. (2020). Students perception of Mobile learning during Covid-19 in Bangladesh: university student perspective.
- Krull, G., & Duart, J. M. (2017). Research trends in mobile learning in higher education: A systematic review of articles (2011–2015). *International Review of Research in Open and Distributed Learning*, 18(7).
- Lieberman, M. (2019, February). Students are using mobile even if you aren't. Retrieved from <https://www.insidehighered.com/digital-learning/article/2019/02/27/mobile-devices-transform-classroom-experience>

SMART POWER LOCK KIT

Ahmad Zhafran Bin Yusof

Politeknik Kota Bharu, Ketereh, Kelantan
zhafran@pkb.edu.my

Wan Amiruddin Bin Wan Mustapha

Politeknik Kota Bharu, Ketereh, Kelantan
amiruddin@pkb.edu.my

Highlights: This paper describes the development of a teaching and learning aid based upon a smart door lock kit that provide convenience for facilitators as well as students in delivering teaching process. This project concentrates primarily on the design and construction of door central locking system which will be used as a tool or teaching medium for Automotive Workshop Practice 2 course. This present invention relates to a central lock system and alarm system for an automotive vehicle and, more particularly, to a remote locking and unlocking system for an automotive vehicle having at least one electrically-controllable door lock and a remote actuator whose transmitter functions as a code key to cooperate with a receiver on the vehicle functioning as a code lock.

Key words: *central lock, alarm system, teaching and learning aid, kit, automotive vehicle.*

Introduction

Vehicle security and making advancement in car features and its technology have been major concern in automobile industries. The safety locking system is designed to prevent accidents happening while opening the car door and to provide safety to passengers. Central lock is function when the key is turned in the driver's door lock, all the other doors on the vehicle should also lock [2]. Motors or solenoids in each door achieve this. If the system can only be operated from the driver's door key, then an actuator is not required in this door. If the system can be operated from either front door or by remote control, then all the doors need an actuator. The main control unit contains two change-over relays, which are actuated by either the door lock switch or, if fitted, the remote infrared key. The motors for each door lock are simply wired in parallel and all operate at the same time. Most door actuators are now small motors which, via suitable gear reduction, operate a linear rod in either direction to lock or unlock the doors. A simple motor reverse circuit is used to achieve the required action. Infrared central door locking is controlled by a small hand-held transmitter and an infrared sensor receiver unit as well as a decoder in the main control unit. This layout will vary slightly between different manufacturers. When the infrared key is operated by pressing a small switch, a complex code is transmitted. The number of codes used is well in excess of 50 000. The infrared sensor picks up this code and sends it in an electrical form to the main control unit. If the received code is correct, the relays are triggered and the door locks are either locked or unlocked. If an incorrect code is received on three consecutive occasions when attempting to unlock the doors, then the infrared system will switch itself off until the door is opened by the key. This will also reset the system and allow the correct code to operate the locks again.

Meanwhile, a car alarm is an electronic device installed in a vehicle in an attempt to discourage theft of the vehicle itself, its contents, or both. Car alarms work by emitting high-volume sound when the conditions necessary for triggering it are met. Such alarms may also cause the vehicle's headlights to flash, may notify the car's owner of the incident via a paging system, and may interrupt one or more electrical circuits necessary for the car to start. This system can be operated by remote control or using the key in a door lock. When first activated, the system checks that the doors and tailgate are closed by monitoring the appropriate switches. If all is in order, the anti-theft system is then activated after a 20-second delay. The function indicator LED flashes rapidly during this time and then slowly once the system is fully active. The alarm can be triggered in a number of ways: Opening a door, the tailgate or the bonnet/hood, removal of the radio connector loop, Switching on the ignition and Movement inside the vehicle. If the alarm is triggered the horn operates for 30 seconds and the hazard lights for 5 minutes. This stop if the remote key or door key is used to unlock the vehicle.

Many teaching tools are used to teach automotive workshop. This ranges from traditional academic lectures, textbooks, hands on shop work and computer based resources [2]. In the educational area of industrial technology, specifically in the study of automobile engineering and associated components, it is necessary to use instructional materials that are able to simulate, test and obtain specific data of operation. There are still theories in the field of automotive which many students find difficult to conceptualize in the real world of modern automobile technology. Despite the effort of highly capable instructors to explain such theories, there is really a need to use instructional mock-ups or trainers to enhance better understanding and apply the principles presented.

Content

1. Description of innovation / product development / design / process.

The objectives of the proposed study are to design and fabricate of smart power lock kit as an instructional trainer which a combination of central lock and alarm systems. This product are easy-to-use, allows for accessible locking and unlocking and provide convenience, utility, and security to vehicle system. This project is design mainly for teaching and learning aid in Automotive Practical Practice 2 module.

Besides, there is a need to carry out the teaching and learning (T&L) process in a relaxed but effective way so that the delivery session in the classroom would be more interesting. The production method of this project is started by designing a kit for a power lock system circuit diagram. It consists of several components such as door actuators, electrical control units, current adapters, LED lights, alarm lights, and sirens. Next, the assembly and connection processes were done on each component. After that, all these components need to be installed in an acrylic box (15.24 cm x 35.56 cm x 60.96 cm). Finally, a testing process is carried out to ensure that the product well functioned.

2. The context or background of the innovation / product development / design / process

The central lock system is one of the security system in the vehicle that opens all the doors in the car when the driver's door is locked and conversely when locking the driver's door, the center lock will lock all the doors. Modern central key systems nowadays are getting better and easier with entry via remote control or without a key. Press a button and the door will unlock, usually by producing a 'tic' sound. Some central key systems, they are much more sophisticated and can also be combined with a garage door opener, this results in movement making getting in and out more smooth and easy. Some center key systems can also lock and unlock the fuel cap. This way, the user do not need to press a button to open the door. Modern central key systems can also have security features that lock the door when the vehicle is moving at a certain speed, open automatically in an accident or an emergency button that triggers an alarm if you feel threatened and want to draw attention to yourself. Through the study, this project will help lecturers as well as students to understand the central key system and alarm system more clearly during the learning session. Therefore, this can increase students' knowledge in more depth.

3. Importance to education

- Used as a teaching and learning aid during learning session
- Make the lecture in the class more interesting; student shows interest in the related topic.
- Enhance better understanding in the classroom as the product attempt to show the main electrical components in a position similar to those on the actual vehicle.
- Improve student's score in test due to the trainer serves as the medium of instruction to help develop the learning of students for the automotive central locking and alarm systems.

4. Advantages of innovation / product development / design / process towards education and community

- Increase level of understanding among students with respect to the lesson topics
- Low cost; as the product easy to maintain
- Lightweight and friendly user
- Batteryless (using electrical power supply)

5. Commercial value in terms of marketability or profitability of your innovation / product development / design / process

- The tool can be used by many parties, especially by technical institutions in order to fulfil their educational studies.
- Due to its low cost, it can be commercial as an instructional trainer in the educational Institutions.
- Highlight dual features in one box; Central locking system and Alarm system.
- As an encouragement to the outside community to learn more about the latest technologies in the automotive industry.

References

- Arnelo D. Naelga, Rene M. Chavez (2017), "An Instructional Trainer Innovation for Automotive Lightning, Car Alarm and Central Locking System", Journal of Engineering Applied Sciences 12 (Special Issues 12)
- Tom Denton (2016), "Automobile Electrical and Electronic Systems", 5th Edition, pages 405 and 433
- Aleksander IBRO, Augusto WONG, Mario ZYLA (2019), "Smart Door Lock", Worcester Polytechnic Institute; MQP MXC -0580

IPS GAME: LEARN BASIC SOLAT THROUGH 3D GAME

Mohamad Fakhri bin Fadzil

Universiti Pendidikan Sultan Idris, 35900 Tanjong Malim, Perak
d097029@siswa.upsi.edu.my

Nadia Akma Ahmad Zaki, Nor Masharah Husain, Nor Zuhaidah Mohamed Zain

Universiti Pendidikan Sultan Idris, 35900 Tanjong Malim, Perak
nadiaakma@fskik.upsi.edu.my, masharah@fskik.upsi.edu.my, norzu@fskik.upsi.edu.my

Highlights: The IPS (Ilmu Pengetahuan Solat) is a three dimensional (3D) digital game with an educational premise that aims to teach students the basics of prayer. The IPS game genre is in the form of exploration and learning and employs a 3D interface to increase students' enjoyment and interest in playing and learning. The basic knowledge of prayer is understood and learned when students face the challenges they encounter in the game. In addition to the use of interesting player characters, this game also has the advantages of different game environments and an exciting storytelling plot. This game is also appropriate as instructional materials or teaching aids in Islamic education to facilitate teaching, learning, and motivating students to learn about basic solat.

Key words: *solat, digital game, 3D game, teaching aids, Islamic education*

Introduction

Islamic education is an essential and compulsory subject for all Muslim students from kindergarten, primary and secondary school. Islamic education covers Aqidah, Shariah, Morals, and general Ibadah and guidance in daily life. Through Islamic education, the development of the character of a good Muslim as an individual and member of society will be promoted. However, the teaching and learning of Islamic Education are uninteresting, and students had lesser interest to learn the subject (Dedi Sahputra, 2020; Zaiton Mustafa & Hishamuddin Salim, 2012).

In line with 21st-century learning, digital games can innovate technology in education, delivery strategies, and content learning presentation. Today, the rapid development of various technology platforms such as personal computers, smartphones and tablets in multiple sizes makes access to digital games increasing and widespread and can be utilized by all ages and backgrounds (Entertainment Software Association, 2020). The game is a structured context with specific rules that allow players to overcome challenges to achieve the ultimate goal of victory. Digital games provide players with an engaging and motivating environment. Digital games also allow players to learn from their own mistakes and gain experience when facing challenges tailored to the player's competence.

The use of digital games is also becoming more widespread in various fields, including education. Among the advantages of using digital games in education is facilitating learners' holistic understanding, obtaining cognitive abilities, providing flexible learning, and improving learning outcomes (Zhonggen, 2019). In addition, the use of digital games can help teachers diversify their teaching methods to provide a learning environment that attracts students and challenges by using game elements in learning. Thus, digital games that use a 3D interface are practical and valuable for teaching and learning Islamic Education subjects to attract students to learn about solat.

Content

Solat, also spelt as salah or salat, are prayers performed by Muslims and one of the five Pillars of Islam. Solat is an essential foundation that needs to be learned and understood in the Islamic Education subject. Teachers often teach solat in conventional ways, which makes students less interested and bored. Teachers also lack the skills and resources to help students learn about solat more engagingly. The use of technology-based teaching aids for Islamic Education subjects has begun to be developed specifically to learn Jawi, Al-Quran, Arabic, Sirah, prayer practice, Aqidah, Hadiith, and solat. However, there are still lacking, especially in the form of 3D digital games. Therefore, IPS games based on the 3D interface are developed to draw students into the knowledge of solat and motivate them.

IPS is a 3D game classified as an exploration and learning game. Exploratory games are used to form training and environmental interactions as a key part of the game (Rego, Moreira, & Reis, 2018). Learning games use entertainment as an added value to encourage and enhance learning training (Hussaan & Sehaba, 2013). Through IPS games, learning about the basics of solat becomes more exciting and fun through activities or challenges that can increase the understanding, motivation and engagement of players.

The IPS game is aimed at users of primary school students aged seven to 12 and teachers. Besides, this game can be used for individuals interested in deepening the basic knowledge of solat, such as non-Muslims who hope to convert to Islam or those new to Islam whose faith still needs to be supported and reinforced. The appropriate use of the platform to play this game is via a tablet or personal computer. The game uses the Malay language, consists of three levels, with learning requirements and different environments at each level. The setting is jungle-shaped, sea and maze.

The use of various environments will make players feel excited and arouse curiosity. In addition, the use of sound effects and background songs also play a role in affecting the player, such as the sound of sea waves, the sound of moving rocks, the sound of birds chirping and the sound when players play. This game also features intriguing player characters and a fascinating storyline.

In this game, players must also pass all obstacles with three lives in each level and answer the quiz to win (see Figure 1). The quiz is becoming increasingly tricky, enabling players to confront the challenge of seeking knowledge. Therefore, if players successfully meet the challenges in the game and answer the quiz correctly, the objective of this game will be achieved.

The development of the IPS game is seen as very significant nowadays, as innovative teaching and learning strategies for Islamic Education subject, particularly on the solat knowledge. In line with 21st-century learning that emphasizes the use of technology in education, the IPS game's production will affect students' interest towards the subject, reduce students' dependency upon teachers and enable students to learn independently, depending on their time and abilities wherever they may be.

Figure 1: The IPS Game Interfaces



Commercialization

IPS games may be marketed for children, teachers, and primary school students in Malaysia. This game can also be marketed to parents who want to encourage their children to pray and teach them how to pray, as well as anyone who wants to learn more about solat. This game can be downloaded from the cloud hub for future plans and can be played via smartphone in any language such as English, Indonesian, Arabic and others.

References

- Dedi Sahputra, N. (2020). Problems of Islamic Education and Solutions. *Proceeding International Conference on Contemporary Islamic Studies*, 160–167.
- Entertainment Software Association. (2020). Essential facts: about the computer and video game industry. In Entertainment Software Association.
- Hussaan, A. M., & Sehaba, K. (2013). Adaptive serious game for rehabilitation of persons with cognitive disabilities. *International Conference on Advanced Learning Technologies*, 65–69.
- Maimun, A. L., Wan Nurul Syuhada*, W. H., & Mohd Isa, H. (2017). Tahap Pengetahuan Dan Kesiapan Guru-Guru Pendidikan Islam Sekolah Menengah Di Selangor Terhadap Penggunaan Multimedia Dalam Pengajaran Pendidikan Islam. *ASEAN Comparative Education Research Journal on Islam and Civilization (ACER-J)*, 1 (January), 1–13.
- Rego, P. A., Moreira, P. M., & Reis, L. P. (2018). Proposal of an Extended Taxonomy of Serious Games for Health Rehabilitation. *Games for Health Journal*, 7(5), g4h.2017.0138.
- Zaiton Mustafa, & Hishamuddin Salim. (2012). Factors Affecting Students' Interest in Learning Islamic Education. *Journal of Education and Practice*, 3(13), 81–87.
- Zhonggen, Y. (2019). A meta-analysis of use of serious games in education. *International Journal of Computer Games Technology*, 2019(3), 1–8.

TEACHING AND LEARNING AID OF AUTOMATIC WINDSHIELD WIPER SYSTEM

Wan Husni Zaim Bin Wan Muhamad

Politeknik Kota Bharu, Ketereh, Malaysia

wanhusnizaim@gmail.com

Mohamad Bin Hitam@Yahaya, Ahmad Suhaimi Bin Arshad

Politeknik Kota Bharu, Ketereh, Malaysia

mohamadhitamyahaya@gmail.com, suhaimi@pkb.edu.my

Highlights: This project was about the invention of automatic windshield wiper system for teaching and learning purpose. It was invented to make the conventional wipers system became fully automatic operated. When droplets of water fell down on the windshield, it would be detected by rain sensor. Then, the signal would be sent to wiper motor through relay to actuate and operate the wiper blade. This would make the teaching and learning process become more comprehensive, effective and interesting. Besides, one of the reasons why this product was produced because it was due to lack of modern teaching and learning aid in this institution. To produce this product, it must go through the planning design, component selection, cost estimation, product testing and product functionality. The result of this project is truly beneficial to instructor and student especially automotive student. It gave more understanding about the knowledge and new technology in wiper system.

Key words: *Automatic, wiper system, teaching and learning aids, innovative, knowledge, invention*

Introduction

Over the past two decades, the automotive industry has aggressively researched ways to exploit modern computing and electronic advances in the development of safety, reliability, and entertainment technologies for vehicles. With drivers exposed to an ever increasing number of distractions, automatic rain-sensing wiper systems become an even more appealing feature, as they work to minimize the time the driver must take his/her hands off the wheel (P.Naresh et al, 2015).

Controlling a wiper system manually can be very problematic in some situations. For instance, heavy-duty vehicle drivers have to control their vehicle's transmission manually. In foul weather conditions, controlling both ABC (Acceleration, Brake and Clutch) and the windshield wiper system is troublesome and can lead to severe accidents [1]. In such a case, automatic windshield wiper systems can greatly aid driver safety and provide a better driving experience (Lubna and Avik, 2015).

The A windscreen wiper or windshield wiper is a device used to remove rain, snow, ice, washer fluid, water, and/or debris from a vehicle's front window so the vehicle's operator can better see what's ahead of them. Almost all motor vehicles, including cars, trucks, buses, train locomotives are equipped with one or more such wipers, which are usually a legal requirement. A wiper generally consists of a metal arm; one end pivots, the other end has a long rubber blade attached to it. The arm is powered by a motor, often an electric motor, although pneumatic power is also used for some vehicles. The blade is swung back and forth over the glass, pushing water, other precipitation, or any other impediments to visibility, from its surface.

The technology in the wiper system has been changing from time to time to adopt the functionality and its efficiency on the challenging weather condition. In this project, there is new innovative feature which had been developed to this windshield wiper system to be fully automatic. When any droplet of water falls down to the windshield or windscreen, it will be detected by rain sensor which it can calculate and determine the amount of water droplet. Then, it actuates and vary the speed of wiper motor to operate it back and forth. This project was also purposely invented for teaching and learning process and used as teaching and learning aid for topic of windshield wiper system. In addition to being able to understand this topic comprehensively, students were revealed by new technology and innovation of windshield wiper system.

Content

1. Description of product development / design / process :

The early stage of this project was designing and gathering information about overall picture of whole innovative automatic windshield wiper system and how it could be done. The main focus in the product development was designing this teaching and learning aid in simplest way, practical, innovative element and able to demonstrate to user comprehensively. Next, the process of component selection along with cost estimation. The project components are rain board sensor, windshield/windscreen with stand, wiper motor, transformer, wire harness, wiper blade and battery. Then, the installation process of all components until it finished. After installation, the testing process was carried out to test its functionality.

2. The context or background of the innovation / product development / design / process :

This project was invented as teaching and learning aid. It would be used in teaching and learning process. This project transformed the conventional wiper windshield into automatic wiper windshield system. The wiper will operate automatically when rain sensor detects the droplets of water fall down onto windshield. The wiper will operate as speed as how much the droplets of water fall onto the windshield.

3. The importance of this innovative teach and learning and learning aid are:

- To demonstrate the and visualize the operation of automatic wiper windshield system effectively.
- To make the teaching and learning process more interesting, innovative, comprehensive and interactive.
- To reveal the innovative element into the teaching and learning aid.
- To elevate the higher standard of teaching and learning process .
- To generate the engineering, innovative, creative and critical mindset to instructor as well as student in teaching and learning process.
- To implement the higher standard of teaching and learning methodology especially for engineering automotive student.

4. The advantages of your innovation / product development / design / process towards education and community

- Teaching and learning process become effective, innovative, creative, mind impulsive, interactive and interesting.
- This product is lightweight, smaller size, not expensive, and easy to be moved.
- All components can be seen and recognized clearly.
- The working principle and operation can be demonstrated efficiently.
- This teaching and learning aid display the innovative element which can make student to open their mind and generate creative and critical thinking in their learning process.
- This project educate student to initiate the creative and critical thinking in engineering solution.
- Teaching and learning process become more up-to-date with the new surrounding technology
- It much safer, user friendly, saving time, saving energy and convenience compare to conventional one.

5. Commercial value in terms of marketability or profitability of innovation / product development / design / process

- This project can be extended to other engineering automotive institution since the cost of its production is not expensive.
- This teaching and learning aid is cheaper than the outside board trainer.
- This product is easy to be produced which all component readily available and its installation process is easy.
- This product promotes new idea and innovation for teaching and learning aid compare the outside board trainer which still implementing the conventional one.

References

- P.Naresh, A.V.Hari Babu (2015)Automatic Rain-Sensing Wiper System for 4-Wheeler Vehicles. JOURNAL OF ADVANCEMENT IN ENGINEERING AND TECHNOLOGY. ISSN: 2348-2931.
- Lubna Alazzawi, Avik Chakravarty2 (2015). Design And Implementation Of A Reconfigurable Automatic Rain Sensitive Windshield Wiper. International Journal of Advances in Engineering & Technology, Apr., 2015. © IJAET. ISSN: 22311963.

'I-MATH 4U'

Ainor Izmira binti Maimun@Mahmood

Politeknik Kota Bharu, Kota Bharu, Kelantan
ainor@pkb.edu.my

Hanisah binti Yusoff¹, Suzilaeli binti Mohd Sarman²

¹Politeknik Kota Bharu, Kota Bharu, Kelantan,

²Politeknik Sultan Haji Ahmad Shah

hanisah@pkb.edu.my, suzilaeli@polisas.edu.my

Highlights: 'I-MATH 4U' is short for intelligent math for you and currently, it is exclusively for 3rd-semester students of Electrical Engineering Mathematics from the Electrical Engineering Department. I-MATH 4U can also be accessed by the lecturers as it is a public website and the website allows user contributions for selected website visitors. I-MATH 4U is established to facilitate the learning and teaching process without the need to have a physical classroom, in which teaching and learning can be done online, anywhere, and anytime by the students as the students can explore the website without any help from the lecturers. I-MATH 4U has been developed to make it easier for the students to access any information related to the Electrical Engineering Mathematics course via smartphone, by visiting the website. Students can also use the website as a one-stop website and the website can be accessed for free using a Google Account. Among the contents available in I-MATH 4U includes class introductions, notes, tutorial, games, collections of final exam questions, online class (online class schedules), chat room, and YouTube videos.

Keywords: *I-MATH 4U, website, access*

Introduction

In January 2020, the World Health Organization (WHO) declared a pandemic situation due to the spread of a new type of Coronavirus that have caused the COVID19 outbreak. In line with the declaration, all countries have closed all sectors including the education sector. The closure of the education sector has resulted in the closure of all schools and higher education institutions to break the chain of transmissions of the virus. As a result, the face-to-face teaching and learning process that has been a practice for a long time had to be stopped following the instructions of the Movement Control Order (MCO). To ensure that the students are not left behind in learning, educators have started to conduct classes online as an option. Choosing a suitable platform is crucial in the teaching and learning process. This is to avoid the complications such as lagging or screen freeze that can be a distraction to the students during online learning that is conducted live. Educators tried their best to be creative in diversifying the teaching and learning methods. Hence, I-MATH 4U was developed to facilitate teaching and learning in the new normal environment so that educators can attract students' interest as well as stimulate students' creative thinking. Learning can be accessed and can be done anywhere and anytime. The learning material can be found in the form of text, graphics, video, and audio and this will indirectly attract the students to explore more. In addition, online chat services will help students to communicate, discuss, and share knowledge directly with the help of friends or experts in their respective fields (Noraini & Shuki, 2009). This will indirectly create a collaborative learning environment in which students will work together to solve a problem during a learning session or outside of a learning session (Muhamad Azhar Stapa, Mohamad Ibrahim, & Amri Yusoff, 2017). I-MATH 4U has shown a big potential to provide support and increase the quality of the teaching and learning process. I-MATH 4U was developed using a specific website platform that contains all information related to the Electrical Engineering Mathematics course that can be easily accessed by all students, including the lecturers. To encourage a meaningful learning environment for the students, the teaching process of Electrical Engineering Mathematics should begin with something that can engage the students by providing input or information on teaching and learning interactively and interestingly. Revolving around new technologies and norms, I-MATH 4U was successfully established. I-MATH 4U is developed exclusively for 3rd-semester students who are taking the course DBM 30043 Electrical Engineering Mathematics at Politeknik Kota Bharu. I-MATH 4U can be used by the students as a source of reference for learning, as well as exercises that contain notes, tutorials, final exam questions from past years, math games, online calculator, chat room, and videos that can be viewed and downloaded as a process of reviewing lessons for the students.

Innovation Objectives

1. Students will be able to access the website anytime and anywhere and they can explore the website without the help of the lecturers.
2. Website is easily accessible, flexible, and user-friendly.
3. Students will be able to use I-MATH 4U as a one-stop website in which they can:
 - Obtain references to the course and do revisions.
 - Answer quizzes and play math games online.
 - Start online discussions with friends.
 - Download teaching and learning materials.
 - Browse for links outside of Google.
 - Easily link learning activities with Google Classroom.

Background of the study

I-MATH 4U is one of the platforms that was developed by Mrs. Ainor Izmira binti Maimun @ Mahmood together with Mrs. Hanisah binti Yusoff and Mrs. Suzilaeli binti Mohd Sarman. The current learning norms based on the latest technology give lecturers an option to utilize I-MATH 4U as one of the media for teaching and learning of students in which in the current situation, most of the teaching and learning processes are done online. This is in line with the current mobile communication technology that is easily accessible and obtained. In a face-to-face classroom, lecturers spent a lot of lecture time teaching and distributing notes and learning support materials. Meanwhile, students will make use of those materials to complete their assignments at home, during their own time. Hence, during this pandemic, modern technology helps the student a lot in making sure that they can complete their tasks and assignments effectively, quickly, and innovatively. Such technology will provide the students a space to think more openly and creatively. When the students are exposed to I-MATH 4U as part of the learning, the students must enhance their knowledge to master this technology more effectively and to use this technology wherever they are. Moreover, I-MATH 4U is developed to ease the learning process, making it more flexible, mobile, and can be accessed anytime and anywhere by the students. I-MATH 4U is developed by using the Google Site software where there are various learning methods or information that can be used and combined. In addition, Google Site provides an advantage to the lecturers because this software can be used to schedule and organize online lessons easily and its status as a public website allows users to edit contents easily. I-MATH 4U can be accessed for free through 'Google Account' anytime and anywhere. Among those contained in this software are Introduction, Notes, Tutorial, Collection of past years exam questions, Games, Videos, Class Schedule and Chat Room.

The Rationalization of Innovation

I-MATH 4U is developed exclusively for Electrical Engineering Mathematics students and for the lecturers as a platform to gain information related to the course. The rationale for this innovation is to:

- i) Make I-MATH 4U as a teaching and learning aid for the lecturers and students who are taking Electrical Engineering Mathematics course.
- ii) Make I-MATH 4U as a teaching aid for the lecturers to be able to conduct online classes more effectively in these times of new norms teaching and learning.
- iii) Help the students to master the topics effectively.
- iv) Diversify the teaching and learning aid to be able to attract students' attention and to make sure students can use it easily without any guidance from the lecturers.

The Innovation's Impacts and Efficiencies

Impacts on PKB, POLISAS and the Department of Science and Computer Mathematics

- To achieve Polytechnic's KPIs towards Industrial Revolution 4.0 (IR4.0) and also Internet of Things (IoT).

Impacts on Lecturers

- Providing diversity in teaching aids accordingly to the current learning development through e-learning.
- Providing a new online teaching experience and skills to the lecturers.

Impacts on Students

- Students will be more confident and more interested in the Electrical Engineering Mathematics course through a creative, innovative, and colourful I-MATH 4U website.
- Students can save time as they can learn and do revisions on their own.
- Students can save money as they don't need to photocopy.
- Students can have a more flexible learning environment anywhere as it does not require a specific place or classroom to learn.

Commercial Value in I-MATH

- Easily accessible without the need to have a physical classroom.
- An original website that contains active mathematical learning modules
- Go Green Technology

Suggestions For Improvements

There are some suggestions for improvements of I-MATH 4U so that it can be used more effectively. Suggestions for improvements include:-

- I-MATH 4U is to be implemented comprehensively to all courses that are offered in Polytechnic and not limited to Electrical Engineering Mathematics course only.

References

- Muhamad Azhar Stapa, Mohamad Ibrahim, & Amri Yusoff. (2017). Kolaborasi dalam Pendidikan Vokasional: Mewujudkan Pembelajaran Teradun Melalui Teknologi Web 2.0 35 Kolaborasi dalam Pendidikan Vokasional: *Mewujudkan Pembelajaran Teradun Melalui Teknologi Web 2.0, Collaboration in Vocational Education: Delivering Blende*. Journal of ICT in Education (JICTIE), 4, 35–51
- Noraini Idris, & Shuki Osman. (2009). *Pengajaran Dan Pembelajaran ; Teori dan Praktis*. McGraw-Hill(Malaysia) Sdn.Bhd.
- Sumaiyah Mohd Khaidzir, Noor Hidayah Jamaludin, Ainor Izmira Mahmood, etc (2017). *Engineering Mathematics*: Polisas Publication, Jabatan Matematik Sains & Komputer.
- Mohd Fadzil Hasbollah, Wan Izyani Wan Jusoh, Nazihah Che Rozan, Ainor Izmira Mahmood (2020). *Engineering Mathematics 3, Problem Solving for Polytechnic Students*, PKB Publication, Department of Mathematics, Science & Computer.

TUTORZONE COST & MANAGEMENT ACCOUNTING 2

Noraihan binti Mamat Zambi

Politeknik Tuanku Sultanah Bahiyah, Kulim, Kedah
noraihanmz4@gmail.com

Noor Hanim binti Ismail, Nor Lailihuda binti Ismail

Politeknik Tuanku Sultanah Bahiyah, Kulim Kedah, Politeknik Sultan Haji Ahmad Shah Pahang
hanim@ptsb.edu.my, norlaili@polisas.edu.my

Highlights: Tutorzone is an innovation in teaching and learning for Cost and Management Accounting 2 course. It promotes constructivism as it mainly facilitates the student to enhance their knowledge and understanding. The instructional design used in Tutorzone is ADDIE; Analyse, Design, Develop, Implement, and Evaluate. The main objectives of Tutorzone is to design, develop and implement an application as a center of many types of questions as a reinforcement activity after class. Due to Covid 19 pandemic and performance in Quizzes and Test, students need to be exposed to various forms of questions in interesting learning material to foster student's interest. The design of Tutorzone is based on the theory of Zone of Proximal Development (ZPD), Scaffolding and More Knowledgeable Other (MKO) by Lev Vygotsky. The development of Tutorzone started with the use of Google Slides which transformed into an app that can be downloaded into a smartphone. Tutorzone can be accessed through this link <https://tinyurl.com/TUTORZONEAPPS> or by scanning the QR code. The questionnaires were distributed to 95 students who are enroll the Cost and Management Accounting 2 course in December 2020, Politeknik Tuanku Sultanah Bahiyah. The result indicated that students had a positive evaluation and agreed on the usage of Tutorzone as a learning tool. The expert reviewers also strongly agree with content, design and usability of Tutorzone. Tutorzone benefit the students in constructing their own learning. This innovation is easy to share and widely disseminated its use with all Polytechnic Malaysia.

Key words: *reinforcement, constructivism, ADDIE, Zone of Proximal Development, apps*

Introduction

Tutorzone is an innovation in teaching and learning for Cost and Management Accounting 2. It is a centre which collects all forms of questions under one app as a reinforcement activity for students after class. It is designed to facilitate the teaching and learning process and it consists of interactive instruction that will gain the students attention in learning this subject.

There are three objectives of this innovation; to design, develop and implement an application as a centre of many types of questions as a reinforcement activity after class, to create meaningful and enjoyable learning tools where the students can construct their own knowledge and understanding and lastly to facilitate online learning processes which create opportunities of learning any time and everywhere.

Design

ADDIE is used as a guiding framework in the development of Tutorzone which consists of Analyse, Design, Develop, Implement, and Evaluate. The learning theory implemented is constructivism where lecturers use to help the students learn and students use their previous knowledge as a foundation and build on it with new things that they learn to enhance their knowledge and understanding.

The design of Tutorzone is based on the theory of Zone of Proximal Development (ZPD), Scaffolding and More Knowledgeable Other (MKO) by Lev Vygotsky. The lecturer creates a collaborative problem-solving environment where students become active participants in their own learning. Tutorzone become the scaffolding tools to help the students to perform better especially in nowadays environment where everything is done online and remotely.

Development

The development of Tutorzone started with the use of Google Slides that transformed into an app and it can be downloaded into a smartphone. Tutorzone was designed specifically for the Cost & Management Accounting 2 course and it has 6 components.





 <p>The screenshot shows the Tutorzone main menu with options: VIDEO, FLIP BOOK, GAMES, CHAT, ABOUT, and APPS. A QR code is also visible to the right of the menu.</p>	<p>Illustration and the actual image of Tutorzone and QR code to access it.</p>
 <p>The 'How to Answer' section lists topics: BUDGETING, COST VOLUME PROFIT, RELEVANT COST & SHORT TERM DECISION MAKING, and VARIANCE ANALYSIS. The 'Tutorial Flipbook' section is titled 'THE TUTORZONE' and 'Cost & Management Accounting 2'.</p>	<p>How to answer consists of guideline videos by the lecturer on how to answer questions. It is a step by step instructions and advice based on the topics of the course.</p> <p>Tutorial Flipbook is an eBook compilation of problem-solving tasks and questions for the students to practice..</p>
 <p>The 'Online Games' section lists: INTERACTION TO COST AND MANAGEMENT ACCOUNTING, BUDGETING, COST ANALYSIS FOR PRICING STRATEGY, RELEVANT COST & SHORT TERM DECISION MAKING, and COST VOLUME PROFIT. The 'Chat with Me' section shows 'PADLET' and 'WHATSAPP' chat options.</p>	<p>Online games comprise of 6 topics of Cost & Management Accounting 2 that were created by the lecturers using Quizizz and EduCandy apps for the students to test their knowledge.</p> <p>Chat with me is a medium for the students to connect and engage with the lecturers. It can be thru WhatsApp or Padlet.</p>
 <p>The 'About Us' section lists 'CONTENT EXPERT' and 'APPS DEVELOPER' with their names and roles. The 'Turn into Apps' section provides instructions for downloading the app on iPhone and Android.</p>	<p>About us is the details of the members and their roles in the development of Tutorzone.</p> <p>Turn into Apps is an instruction for the student to download Tutorzone and turn it into an app according to their types of smartphone.</p>

Figure 1: Details of Tutorzone's Components

Result

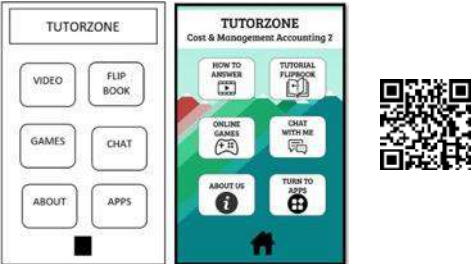
Tutorzone is subjected to expert review and testing before being implemented with the purpose of improving the design and usability of the innovation, and the experts' reviewers strongly agree with every aspect assessed.

A questionnaire was distributed among 95 students of Diploma Accountancy from the Commerce Department, Politeknik Tuanku Sultanah Bahiyah, Kulim. The data collected uses descriptive analysis methods and analysis by using percentage and mean. Table 1 shows that the overall mean for student's evaluation is 3.24. The result indicated that students had a positive evaluation toward Tutorzone, and they agreed on the usage of Tutorzone as a learning tool.

Table 1: overall mean for student's evaluation

Items	Means
Tutorzone apps use easy language for better understanding	3.29
Tutorzone apps provide many types of questions from many interesting platform	3.23
Tutorzone apps provide the interesting design	3.24
The design of Tutorzone apps can increase the student's motivation	3.28
The design of Tutorzone apps can create enjoyable learning process	3.25
The design of Tutorzone apps can encourage for active learning	3.25
The design of Tutorzone apps can create student centered learning environment	3.16
Students can easily access learning material from Tutorzone apps	3.2
Tutorzone apps is useful for learning	3.25
Tutorzone apps were convenient to use for leaning	3.24
Tutorzone apps is the one stop center for the many types of questions from many platforms. Tutorzone apps is suitable for reinforcement activity after class	3.22
	3.2
	3.24

Novelty, Benefit & Commercialization

Tutorzone is a creative innovation tool to make the teaching and learning process more meaningful and significant. It is a centre which collects all forms of questions under one app as a reinforcement activity for students after class. Tutorzone benefit the students in constructing their own learning. They will grow within their zone of proximal development and become more confident, that will help them to perform better. It also benefits the lecturer in guiding the students especially in reinforcement activity for students after class.

In term of commercialization, it helps other educators to construct students' knowledge and understanding using Tutorzone via smartphones to retain their knowledge and make connections for new learning. It is easy to share and widely disseminated its use with all Polytechnic Malaysia. The designer can conduct consultation or workshop on the practical ways using Google Slide as a free app in teaching & learning process.

References

- Western Governors University. (2020, May 27). What is constructivism? <https://www.wgu.edu>. <https://www.wgu.edu/blog/what-constructivism2005.html>
- McLeod, S. A. (2019, July 17). Constructivism as a theory for teaching and learning. Simply Psychology. <https://www.simplypsychology.org/constructivism.html>
- Tam, M. (2000). Constructivism, Instructional Design, and Technology: Implications for Transforming Distance Learning. *Educational Technology and Society*, 3 (2).
- Vygotsky, L. S. (1978). *Mind in society: The development of higher psychological processes*. Cambridge, MA: Harvard University Press.
- Fulbrook, P. (2019, April 18). 15 Learning Theories in Education (A Complete Summary). [https://Teacherofsci.Com](https://teacherofsci.com). <https://teacherofsci.com/learning-theories-in-education/>
- Kurt, S. "Vygotsky's Zone of Proximal Development and Scaffolding," in *Educational Technology*, July 11, 2020. Retrieved from <https://educationaltechnology.net/vygotskys-zone-of-proximal-development-and-scaffolding/>
- Feldman, R. & Sanger, J. (2007). *The text-mining handbook: Advanced Approaches in analyzing unstructured data*
- Sutarto Sutarto, Dewi Purnama Sari, Irwan Fathurochman (2020). Teacher Strategies in Online Learning to Increase Students' Interest in Learning During Covid-19 Pandemic. Vol.8, No.3.pp 129-137.
- Darmalaksana, W, hambali, R. Masrur, A & Muhlas, M (2020). Analisis Pembelajaran Online Masa WFH Pandemic Covid 19 Sebagai Tantangan Pemimpin Digital Abad 21. *Karya Tulis Ilmiah Masa Work from Home (WFH) Covid 19 UIN Sunan Gunung Djati Bandung*, 1-12.

i-KIAMAT PROTOTYPE: INFORMATION OF 'KIAMAT' TERMINOLOGY IN AL-QURAN

Khairul Asyraf Mohd Nathir

Universiti Sains Islam Malaysia, Nilai Negeri Sembilan
khai.asyraf@usim.edu.my

Siti Nur Baiin Che Harun

Universiti Sains Islam Malaysia, Nilai Negeri Sembilan
sitinurbaiin@usim.edu.my

Highlights: In instigating the understanding of each verse related to the Day of Judgment in the Quran, the terminological approach is widely used in explaining the verses related to the Day of Judgment. However, this approach is still not fully used to get a clearer picture of the actual chronology of the Judgment Day. This study aims to determine the terminology of Judgment Day in the Quran by identifying information and establishing an online information space for Muslim sustainability. Data were obtained through document analysis of the Quran using qualitative research. Based in this, an i-Kiamat Prototype application is created.

Key words: *i-Kiamat, information; terminology; kiamat; Quran; application*

Introduction

The understanding of the secrets in the Quran is closely related to its syntactical structure and the style of language used. A large number of Quranic verses describes of the existence of Allah SWT, the creation of the universe (Saipolbarin, 2015) and natural phenomena. Almost 17% of those verses are related to the Judgment day events (Qutb, 2006) which are displayed in the form of vocabulary, verses and chapters with different language styles.

The variation of words in the Quran gives an idea of the richness of terminology in forming a verse through different chapters. Al-Qurtubi (2016) asserts that, the terminology of the Judgment Day in the Quran is one of the most mentioned verses and chapters which include some chapters that are specifically named the Day of Judgment. These different forms of terminology raise the question to the reader on the many variations of Judgment Day terminology in the Quran. Whereas the understanding of its meaning is the same i.e. the destruction of the world leading to the afterlife.

Based on the previous studies, there is a high probability that an understanding of Judgment Day terminology is the key to a comprehensive understanding of Judgment day events. This study focuses on the terminology of Judgment Day through the Quran highlighting on the meaning of the picture of Judgment day and covers the entire meaning of human life. It is anticipated that this study can form an approach that might bridge the gap in understanding the vocabulary of the Judgment Day in the Quran through i-Kiamat.

Content

DESCRIPTION OF METHODS

STAGE 1, The study begins by conducting research on reference materials related to the terminology of Judgment Day which have been categorized in the Quran.

STAGE 2, Research on the validity and reliability of Judgment Day terminology data in the Quran was done. Data were analyzed and triangulation was performed through the validation of experts in the field of Arabic language and the Quran.

STAGE 3, The design an innovation based on the data were obtained. This innovative design (i-Kiamat) will be constructed based on instructional design steps modified from the ADDIE Model (Gagne & Keller, 2005). It consists of five main phases, namely analysis, design, development, implementation and evaluation. This innovation (i-Kiamat) can be generated through websites and applications in smartphones.

PHASE 1: ANALYSIS

The selection of inputs are fundamental in the development of innovation which will determine the position of the appropriate Judgment Day terminology based on the context of the Quranic verses.

PHASE 2: DESIGN

The "Blue print" of the innovation (i-Kiamat) process involves the details on the Judgment day terminology based on the context of the Quranic verses which allow for a parallel understanding of the meaning.

PHASE 3: DEVELOPMENT

"Translate" the Judgment Day terminology specified in Phase 1 and Phase 2 to the i-Kiamat prototype for better understanding.

PHASE 4: IMPLEMENTATION

In this phase, an experimental approach will be used to a total of 100 respondents that are students who are studying in a Bachelor of Arabic Language and Islamic Literature at Universiti Sains Islam Malaysia.

PHASE 5: EVALUATION

Research instruments will be used in this study. It is a set of 20 questions which are related to Judgment Day terminology that can be found in i-Kiamat.

A description of the process is as follows:

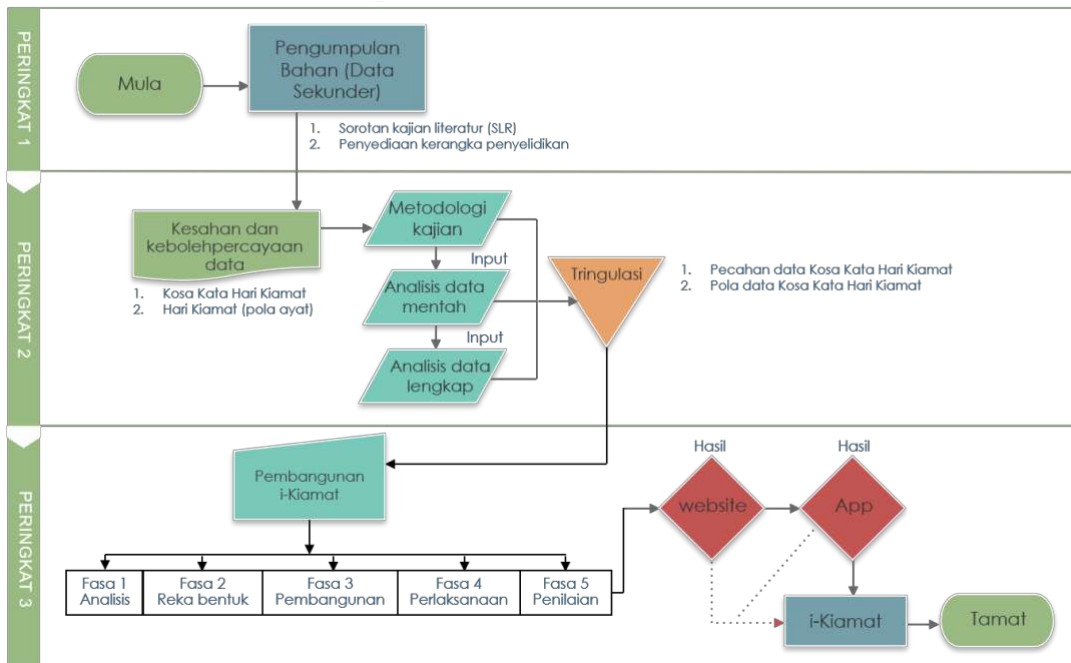

BACKGROUND OF I-KIAMAT

1. i-Kiamat prototype was created using Progressive Web Apps (PWA)

2. There are five main parts in i-Kiamat, namely:

- a. Main
- b. Search
- c. Markers
- d. Profile
- e. Settings

3. In the main section, users will see the first terminology which is al-Kiamat along with general details as well as other terminology options for direct selection.



4. Users who have downloaded this application will be able to use 10 terminologies for free. To see other terminologies, users need to obtain the complete access by buying a specific property.

THE IMPORTANCE OF I-KIAMAT IN EDUCATION

1. This prototype will contribute to the process of Teaching and Learning Balaghah subject (2021):

- Vocabulary in three languages Arabic, English and Malay.
- Expressions used based on the Quranic language.

2. Contribution of terminology based on variations of kiamat wordings in al-Quran (2019)

- High frequency kiamat vocabulary, medium frequency kiamat vocabulary and low frequency kiamat vocabulary.

3. Contribution of terminology based on systematic literature highlights over 30 years (1988-2018)

- General debate on Judgment day signs, partially specific debates (language style), specific language (Judgment day terminology)

BENEFITS OF i-KIAMAT

1. Accumulate a number of words of the Judgment Day in the Quran based on different variations.
2. Display in the form of simple and concise graphics and descriptions.
3. Assists to enrich vocabulary through tadabbur verses of the Quran.

COMMERCIAL VALUE

1. Higher Education Institution
2. Secondary and Primary school
3. Tadabbur Centre

References (Use list your references using APA Referencing format)

- Al-Qur'an al-Karim
Al-Qurtubiy, I. (2004). *Al-Tazkīrah bī Ahwāl Al-Māuti wa Ūmur Al-Akhīrah*. Mamlakatu al-Arabiyyah al-Saudiyyah: Maktabah Dar al-Manhaj.
- Az-Zuhailiy, W. (2014). *Tafsir al-Munir: Fil 'Aqidah wa al-Syariah wa al-Manhaj*. Jakarta: Gema Insani.
- Hanik, M. (2004). Penggunaan Gaya Bahasa Perbandingan Dalam Ayat-Ayat Al-Qur'an Tentang Hari Kiamat. *Bahasa dan Seni*, 32(2), 175-189.
- Jasmi, K. A. (28-29 Mac, 2012). Kesahan dan Kebolehpercayaan dalam Kajian Kualitatif. *Kursus Penyelidikan Kualitatif Siri 1*, pp. 1-6.
- Jasmi, K. A. (2013). *Al-Qur'an Satu Mukjizat yang Menakjubkan. Penciptaan Manusia dari Perspektif al-Qur'an*. Skudai, Johor Bharu: Penerbit UTM Press.
- Khairul, A. M.N, Mohd S. O., Nik F. M., Wan M. W. S. (2019). Variation Words of Kiamat in Qur'an: A General Review. *International Journal of Humanities, Philosophy and Language*. Vol 2. No. 5. Hal 25-40.
- Khairul Asyraf Mohd Nathir, Mohd Sukki Othman, Nik Farhan Mustapha, Wan Muhammad Wan Sulong. 2020. Research on Judgment Day: 30th Years Systematic Literature Review (1988-2018). *UMRAN - International Journal of Islamic and Civilizational Studies*. 7(1). 85-101.
- Qutb, Sayyid. (2006). *Masyahidul al-Qiamah fi al-Qur'an*. Kaherah: Dar al-Syuruq.
- Qutb, Sayyid. (2004). *al-Tasywir al-Fanniy fi al-Qur'an*. Kaherah: Dar al-Syuruk.

MOBILE APPLICATION OF AR SURAH AD-DHUHA

Aslina Saad

Universiti Pendidikan Sultan Idris, Tg. Malim, Perak.
aslina@fskik.upsi.edu.my

Muhammad Aqmal Firdaus b. Azlin

Universiti Pendidikan Sultan Idris, Tg. Malim, Perak.
Aqmalfirdaus84@gmail.com

Highlights: This research focuses on the development of mobile application of Surah Ad-Dhuha, the 93rd of 114 surah in Al-Quran by using Augmented Reality (AR) technology. This app is used to learn Surah Ad-Dhuha interactively in various aspects namely recitation, memorization, *tajwid* and moral values (lessons from each verse). The target is to expose everyone, especially Muslim children, to learn surah Ad-Dhuha in a more enjoyable environment. It also includes quiz to assess their understanding besides several interesting AR videos. The methodology employed was evolutionary prototyping with object-oriented analysis and design approach.

Key words: *Augmented Reality, Mobile application, Learning Al Quran, Interactive, Surah Ad-Dhuha*

Introduction

Mobile learning (M-learning) offers various advantages, especially its flexibility that makes many people nowadays adopt it. The Covid-19 pandemic has increased the popularity of M-learning as most schools and educational institutions are closed. The use of M-learning ensures the learning process continues without exposing everyone to risks. Mobile technology is essential to ensure the successful implementation of M-learning and one of the technologies is mobile application. AR technology within mobile applications has positive impacts on students in numerous aspects.

The AR Surah Ad-Dhuha is a mobile application which has AR functionality and contains videos explaining the meaning of the eleven verses of this surah. It is a great source of M-learning, as the meaning and the lesson learned in each sentence (verse) in this surah is explained via AR videos. Besides, the recitation and *tajwid* of this surah is included as a guideline for the users to recite this surah correctly. Quizzes are available for users to assess their understanding of various aspects in this surah, making it a holistic reference.

The learning process via AR Ad-Dhuha is more interactive if compared to just using the book solely. The significance of this study is to encourage children to read books and understand Al-Quran in an interesting environment.

Description

This AR mobile application that is based on a story book 'Tafsir Mini Surah Al-Dhuha' comes with a picture-based story map. There are four main functions in the app as follows:

1. Users can Scan AR videos. This section needs to be used with the Ad-Dhuha story map. It uses two dimensional (2D) image for 13 animations to demonstrate the lessons learn from the 11 verses, • users can view notes of the *Tajwid*
2. Listen to the recitation, and
3. Users can play games that test the memorization (sequence of the surah) and meanings of the verses (Moral values).

Prototyping methodology that consists of requirement analysis, quick design, build prototype, user evaluation and refining prototype phases was used in this study. Various tools were used to construct different aspects of the software namely Adobe Photoshop, Unity, Microsoft Visual Studio and Vuforia.

Background

AR technology is currently used in a plethora of mobile applications, including those related to advertising, healthcare, tourism, education, commerce and sports. Shalini et. al, (2020) asserts that mobile AR is one of the most explosive growth areas for AR applications. M-learning has an impact on students' learning and motivation through extending the learning space, facilitating collaboration and interacting with course content. Garzon et al. (2020) stated that generally studies show that M-learning contributes to students' retention and satisfaction with learning content.

However, studies on mobile AR especially related to Islamic Study education is still limited despite the affirmation of its positive impact on students' learning outcomes and motivation. According to Standard Curriculum for Primary Schools, students of year 6 primary school will be assessed in several aspects of learning Al-Quran:

recitation, memorization and *tajwid* in Islamic Study subject. Besides, the same components are also assessed in *Ujian Penilaian Kelas Kafa (UPKK)*.

Although various resources are available to learn Al-Quran, a holistic resource consists of *tajwid*, *recitation*, *memorization* and lessons learned (moral value) is still limited and delivered in isolation. Besides, the current available resources to learn Al-Quran are unattractive and using books solely is found dull and boring from children's perspectives. The current generation is more towards using gadgets and apps in their daily life but most current apps and AR focus on games and entertainment. This app fulfils children's desire to use gadgets in positive ways.

Importance to education

The use of AR surah Ad-Dhuha encourages independent learning via M-learning. It can be used anywhere and anytime on a 24/7 basis by anyone who intends to learn Al Quran in a more interesting environment. This app overcomes the internet accessibility issue faced by most teachers and students in this era of *PDPR*. Primarily, school teachers who teach for *UPKK* assessment or Islamic Study subject can use this app as a learning material to support the aspects of memorization, recitation, *tajwid* and lessons learned in a more enjoyable environment. Hence, it may enhance children's skills in reading the Quran with correct *tajwid* and memorizing the surah.

Furthermore, parents can use this app as an M-learning tool to assist their children in *PDPR* at home as most schools are currently closed due to the Covid-19 pandemic. It fulfils children's desire to use gadgets positively and distracts children from using mobile devices only for entertainment purposes.

Specifically, Early Childhood teachers can teach good manners to their children interactively via an active and fun learning environment. The use of cartoon characters in the AR videos and attractive interfaces maintain children's interests in reading the story book. As a result, they may understand the Quran in an easy way via AR videos. It is hoped that using this material will increase students' achievements in various aspects of Islamic Study in the future.

Advantages

This app offers various advantages for users. It is a complete and holistic resource of surah Ad-Dhuha that can be used as a reference material. Besides, this app is developed using Child Computer Interaction (CCI) principles that involve the design of software suitable for children. Simple interfaces yet meaningful and colorful provide the feelings of joyful while using the app. Interactive images, proper tunes and sounds, animations, AR videos cartoon characters and their mixing manage to maintain children's interests while reading the story book. Easy and suitable tasks (drag and drop) for the memorization of the surah's sequence meet the CIC principles. Furthermore, rewards to students increase students' motivation in the learning process.

This app can be accessed anytime, anywhere by anyone with no Internet access and is adaptable to any devices that use Android as an operating system. This mobile application has the ability to provide quality performances to users as it is designed using a systematic object-oriented approach, taking into account all the functional and non-functional requirements of a comprehensive mobile application.

Commercial value

This AR Surah Ad-Dhuha is marketable to teachers, parents and children. To evaluate the usability of the AR Surah Ad-Dhuha, a questionnaire was distributed to 50 respondents. All 16 items regarding usability of the application were asked using 5 Likert scale. The mean for all the items was between 3.94 and 4.62, indicating this app is useful for users. For commercialization, QR code can be generated and attached to the book or on the mind map. Users can scan and download the app that cost only 1USD or equal to RM4.00. Alternatively, it can be downloaded from google play store.

References

- Akçayır, M. & Akçayır, G. (2017). Advantages and challenges associated with augmented reality for education: A systematic review of the literature. *Educational Research Review* 2017-Elsevier doi: 10.1016/j.edurev.2016.11.002.
- Bhadra, A., Brown, J., Ke, H., Liu, C., Shin, E., Wang, X. & Kobsa, A. (2016). Using an augmented reality mobile game to enhance literacy in early childhood. *016 IEEE International Conference on Pervasive Computing and Communications Work in Progress*. 978-1-5090-1941-0/16/\$31.00 ©2016 IEEE
- David Prochazka, Michael Stencl, Ondrej Popelka, Jiri Stastny. (2011). Mobile augmented reality applications. *Proceedings of Mendel 2011: 17th International Conference on Soft Computing*, pp. 469-476, ISBN 978-80-214-4302-0]
- Garzón, J., Baldiris, S., Gutiérrez, J., & Pavón, J. (2020). How do pedagogical approaches affect the impact of augmented reality on education? A meta-analysis and research synthesis. *Educational Research Review, 2020 – Elsevier*.
- Radoslava, K. (2017). Designing an interface for a mobile application based on children's opinion. *International Journal of Interactive Mobile Technologies (IJIM)* 11(1), 53-70.
- Wu, H.K., Lee, S. W., Chang, H. Y. & Liang, J.C. (2013). Current status, opportunities and challenges of augmented reality in education. *Computers & Education*, 62(), 41-49.

MOBILE ROBOT DEVICE TRAINER (MoRDeT)

Suriati Ramle

Politeknik Kota Bharu, Kota Bharu, Malaysia
suriatiramle@pkb.edu.my

Ct Salwaniee Bahayahkhi, Wee Siuw Sia

Politeknik Sultan Mizan Zainal Abidin, Dungun, Malaysia
salwaniee@psmza.edu.my, siuwsia@psmza.edu.my

Highlights: MoRDeT is an innovation of teaching aids that has been developed for the Embedded Robotics (DEC50122) course offered at the Department of Electrical Engineering, Polytechnic Malaysia. This innovation was produced specifically to overcome the problem of lack of teaching aids equipment while conducting practical work. In addition, MoRDeT used to increase student's understanding about the concept of input, processor and output device in constructing a mobile robot. This board is equipped with three 3 input devices which are push button, ultrasonic and gyro accelerometer sensor. The Wemos D1R2 board is used as a processing device because this board has the ability to access the internet. Meanwhile, the output device consists of a Light Emitting Diode (LED), Buzzer and Direct Current (DC) motor. The project was built by adapting the use of the Internet of Things (IoT) through the Blynk application linked with the Wemos board in line with the requirements of the Industrial Revolution 4.0 (IR 4.0).

Key words: *Mobile robot, Wemos, input, output, processor.*

Introduction

Embedded Robotic (DEC50122) course is an elective course offered to semester 4 and 5 student Diploma in Electrical and Electronic (DEE), Diploma in Electronic Engineering (Communication) (DEP) and Diploma in Electronic Engineering (Computer), Sultan Mizan Zainal Abidin Polytechnic (PSMZA). Based on first Course Learning Outcome (CLO1) for this course student necessity to investigate the concept and fundamentals of mobile robotic, embedded controller, sensors and actuators based on land mobile robot design (Course Information, 2019). Therefore, students need to understand and master the concept of mobile these robots, detectors and actuators to achieve the CLO. Meanwhile, in third CLO's (CLO3) students have to manipulate the application of sensor and actuator, robot identification and communication during practical work based on land mobile robot design (Course Information, 2019).

Teaching aids can help students understand more clearly as well as be able to gather information systematically because the use of teaching aids can help lecturers explain things and concepts of learning content more accurately than oral explanations (Azman et al. 2014). Student's knowledge is an important factor in producing quality students. Theoretical knowledge is a very important element before doing any practical work. Students need to master good theoretical knowledge because throughout the process of the theory, there are many work procedures emphasized so that students can perform practical work while in the workshop (Mohamad & Nurhafiza, 2010). However, the deficiency of learning aids makes it difficult for the lecturer to explain about the concept of mobile robots. Considering problems occur, a new innovation has been developed to overcome the deficiency of learning aid and at the same to its help to improve student knowledge in this course.

This innovation was also built by adapting the use of the Internet of Things (IoT) through the Blynk application in line with current technology heading towards Industrial Revolution 4.0 (IR 4.0). The use of this board indirectly exposes students to the technology progress in addition to attracting students to explore further about new phases in the industrial revolution.

Method and Materials

Basically, this project is divided into two main parts which are hardware and software. The hardware part consists of three sections that are input, process and output. The input part consists of a push button, Blynk apps, ultrasonic and gyro sensor. Then the Wemos D1R2 board based WiFi enabled microprocessor unit on an Arduino-UNO footprint will be the main part of the process (Jainrk, n.d). Then, there were four outputs of this board: buzzer, LED, Blynk apps and DC motor. Meanwhile, the software part is a series of programming based on desired output written in appropriate C language for Wemos circuits. The program has been written, compiled and uploaded using open source Arduino IDE software. The circuit as shown in Figure 2 was designed using Fritzing software and converted to printed circuit board (PCB) layout using Proteus software to produce the board.

Result and Discussion

Figure 1 shows the design of the MoRDeT board and its accessories. This innovation facilitates students to make circuit connections using the 'plug and play' method. Students need to make connections from input to processor, and from processor to output to see the outcome. By this way carelessness during circuit connection that can cause a short circuit can be avoided because this situation causes damage to the processor board and devices. This board encourages students to explore more about the application of sensors in daily use other than mobile robots because students can mix and match the sensor with an output based on need. This project is still in the process of applying a copyright from Intellectual Property Corporation of Malaysia (MyIPO) with case number reference LY2021E02516.



Figure 1: Design of MoRDeT

Conclusion

This innovation project has been successfully developed and functions perfectly. It is suitable for all students who take this course in polytechnics all over Malaysia can use this board easily. By using this board, it can create a fun teaching and learning process since students can discover more about the use of sensors, actuator, mobile robot and embedded controller as outlined in course outcome. This project also give student ideas and experiences to prepare their final year project later.

Acknowledgement

We would like to express gratitude to all staff and students of the Electrical Engineering Department, Sultan Mizan Zainal Abidin Polytechnic for supporting us in doing this research. Their contributions are sincerely appreciated and gratefully acknowledged.

References

- Azman, M.N.A., Azli, N.A, Mustapha, R., Balakirshnan, B., & Mohd Isa, N.K. (2014). Penggunaan Alat Bantu Mengajar ke Atas Guru Pelatih bagi Topik Kerja Kayu, Paip dan Logam. *Sains Humanika* 3 (1), 77-85. <https://sainshumanika.utm.my/index.php/sainshumanika/article/view/530>
- Course Information (2019). DEC50122 Embedded Robotic. Version: 230419_1_Effective: June 2019. (pp.1-2). Jabatan Pendidikan Politeknik dan Kolej Komuniti
- Jainrk,. (n.d). Programming the ESP8266 WeMos-D1R2 Using Arduino Software/IDE [Online Image]. Programming the Wemos using Arduino Software/IDE. <https://www.instructables.com/Programming-the-WeMos-Using-Arduino-Software/IDE/>
- Mohamad, A.R., & Nurhafiza M. (2010). Persepsi Pelajar-Pelajar Institut Kemahiran Mara (IKM) Terhadap Proses Pengajaran Dan Pembelajaran Program Sijil Teknologi Elektrik Domestik Dan Industri Yang Sedang Mereka Ikuti. *Journal of Technical, Vocational & Engineering Education*. 2 (2011), 50-63. <http://eprints.utm.my/id/eprint/13394/1/JTVEE-2011-2-004.pdf>

HUBEE ROBLOX ENGLISH LANGUAGE LEARNING: GLOBAL DIGITAL CHANGE-MAKER IN THE MAKING

Nor Hanim Mustafa

Universiti Malaysia Kelantan, Kota Bharu, Malaysia
norhanim@umk.edu.my

Nur Hafezah Hussein

Universiti Malaysia Kelantan, Kota Bharu, Malaysia
nhafezah@umk.edu.my

Highlights: This project recommended an innovation matrix for English language learning to enable educators producing students who are not only competent in English language, but also building up their students' talents in innovation. This innovation matrix is composed of four domains; Hunter, Builder, Explorer and Experimenter. These 4 realms provide the English educators a path on how to embed the concept of innovation in their syllabus. At the end of the project, students would be able to produce a Roblox game guided by a story board developed in one of the domains in this matrix. Roblox is a platform that can generate income for the developer. Therefore, this Roblox game encourages students to be an entrepreneur by combining their creativity, self-determined learning and team work to come out with their best user-generated world and thus will be attractive to many users to visit the world that they develop. The project essentially represents the blend of imagination of the students, self-determined learning, and collaboration to solve the real-world problem arises around them. It is a tool that doesn't tell you why to innovate but this is a tool for those educators who have already decided the worth of young generations of innovators. This invention is useful for those who looking for guidance on how to accomplish the production of successful young creative generation.

Key words: *Roblox, class technology, student learning, SLA, e-learning*

Introduction

Kacar (2020) revealed that the learner-centered constructivist learning environment encouraged the building of knowledge. Students were actively involved in information sharing and recorded enjoying the exchange of feedback with other group members while expanding their information of the pedagogical material (Godwin-Jones, 2006; Petersen et al., 2008; Sun, 2010). This suggested that students who work in partnership and are granted flexibility in the learning process have a greater propensity in their learning process to succeed. Teaching and learning strategies are very vital in order to boost the students' motivation to learn. Debate continues on the best approaches to improve the motivation of the learners. In 2011, Ming et al. presented that Malaysian teachers need to pay greater attention to students with lower skills to break the violent cycle. It includes offering a safe and stress-free atmosphere, as well as immersive and innovative English learning activities.

Background of the innovation

This project consists of 4 suggested domains that help students create and design their own Roblox world and allow English teachers to integrate as much language feedback into all proposed stages. Through the Hubee Roblox feature, 4 stages are proposed to allow learners to experience four domains to become innovators. Its implementation adapts the problem-based learning (PBL) which is not recent at Malaysian Higher Education Institutions (HEI). It started with the medical programmes and other academic programmes such as engineering, technology, economics and others more than two decades ago (Hashima & Samsudinb, 2020). One approach to retaining the concept of problem-based learning is to solve problems through games or other practise. Internet games that are trendy among kids and youngsters nowadays are online Roblox games. "Corp. Roblox.com"(2020) describes Roblox as a global network where millions of people meet every day to visualise, create and share experiences with each other in immersive, user-generated 3D world. Mastroberti (2020) surveys indicated that games, especially digital games, are the most popular entertainment among researched children and adolescents: about 80% would prefer to play with smartphones or consoles rather than reading comics or books. Playing games as entertainment typically comes first even when compared with watching animation films or live-action shows, particularly for boys (Mastroberti, 2020).

Description of the innovation

This project comprises of 4 suggested domains which help the students to produce and design their own Roblox world and make it possible for English teachers to embed as much as language input in all the stages proposed. 4 stages are proposed to enable the learners experience four domains towards becoming an innovator via Hubee Roblox feature.

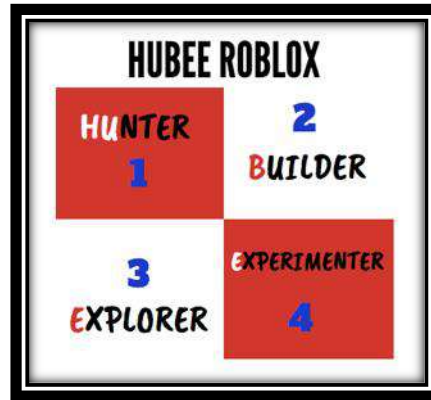

Figure 1: Domains in HUBEE Roblox

DOMAIN 1: HUNTER

Description:

1. This is a pair share technique
2. Teacher encourages the "hunting process" which highlight the hunting process for the issues happening in their surrounding community first, and it must be done by students individually, not in group because we don't want some of the students to be the sleeping partner
3. In respective partner, they combine the information that they gain and they both choose the best information which they decide together regarding the gap that they found in community. In this phase, everyone shares responsibility and makes substantive decision together.
4. In this stage students discuss the issues of society, the problem that happens around the world regarding the issues and find the possible solution of the problem.
5. Along the process, in the articles or any written information that they gain, students need to identify verb and students also need to identify part of speech. This means, when they read the article, they need to learn about verb, noun etc.
6. In the activity students need to record a 2minute video of themselves talking about the best solution to solve the issue. This is to develop the self-confidence. At first, they might feel shy but after they see the other students' video, they are motivated to improve themselves.
7. In this domain also, students are asked to reach the community to interview or observe the problems that happen in the community.

DOMAIN 2: BUILDER

Description:

1. It is a collaborative activity, everyone will have their own responsibility
2. In this domain, students will be requested to transform their solutions that they find in the first domain, into a story line and further develop their artificial world in Roblox.
3. Teacher will be functioning as the facilitator for the students to build up their world feature based on the solutions and gaps they studied in domain 1.
4. At this stage, the students use gamification to solve the identified real-world problem
2. Students are given autonomy to do what they want to do
3. Roblox is like their on world (artificial world), and they have the issues to solve in their world which is derived from the result in domain 1.
4. Everyone has the responsibility, to design the building, the character, the dialogue, the story line, study the best material. Thus, this supports the concept of 21st century learning where the element of collaboration is installed. As far as teaching English as a second language is concerned, designing Roblox is similar like designing the storyline which has the issues to be resolved. Thus, the lesson is more meaningful as the students do not really realize that they actually has come out with something similar with the traditional classroom product.
5. This lesson creates the value of owning the world, where everybody is responsible to take care of the world, and solve any issues that exist in this world.

DOMAIN 3: EXPLORER

1. This is the stage that students explore the opportunity to spread the awareness among people around the world
2. It is a sharing session of what they have done in this project.
3. They reach the society again and explore any possible chance to market their product which is the world of Roblox that they have designed in Domain 2.
4. Therefore, we will see the video of our students skype with the other pupils in other countries such as Indonesia etc
5. Students need to share a lot about their awareness campaign that they do in this project
6. This stage encourages the students to believe that they can be a change maker

DOMAIN 4: EXPERIMENTER

1. This is the stage that students experiment their final product either it works efficiently or not.
2. A pre-and post evaluation is done in order to assess the marketability as well as its practicality for the users.
3. They reach the society again and explore any possible chance to ask the users regarding their opinion and views after using their final innovation product.
4. Therefore, we will see the collections of data and the video of students presenting their findings.
5. Students need to make improvement based on the feedbacks that they get from this process.

The Implementation

We develop this HUBEE Roblox innovation matrix by following the steps in Technology Readiness level(TRL), and thus we also provide the timeline of its implementation for the users especially regarding the pilot project of this innovation as illustrated in the Diagram below:

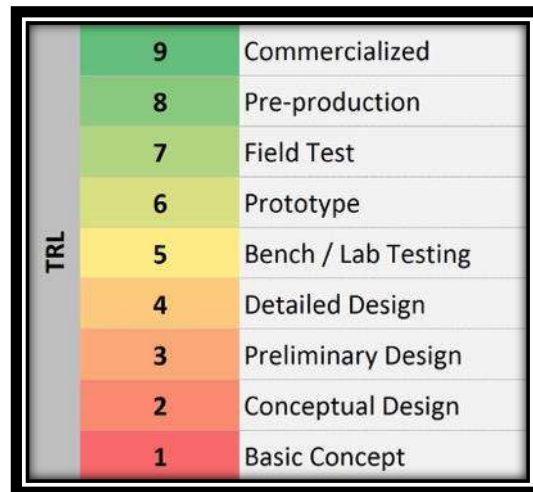

A need analysis entitled "English Language Problem-based Learning via user-generated 3D world Roblox Module: Need Analysis" has been done and we have submitted the paper to a journal for further review. It has been presented in International Conference on Ummah, Digital Innovation, Humanities and Economy 2020.

The timeline for our project will be as following:

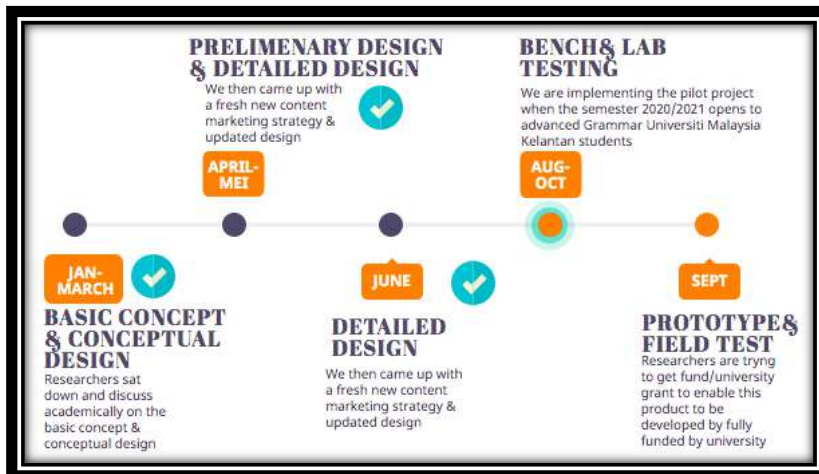

Commercialization

HUBEE Roblox has important commercial prospects both in Malaysia and abroad. Since it is an educational system it can be marketed locally and globally to all educational institutions. It is also valuable as the inventors can charge for any training in HUBEE Roblox. Finally, a handbook will be created on this framework, which will also be marketed by publishers.

Advantages

As far as language teaching is concerned, the agreement to use games in a second language lesson can be found in such a way as to offer students a lot of benefits through games. It gives the students autonomy in this context to create their own game. Many accomplished academics have guaranteed that games are of instructive value. Lee cites a few explanations as follows (Lee, 1995): games allow to escape from peculiar daily practise, but they are essential to inspiration and difficulties. HUBEE ROBLOX also provides consolation in engaging and effectively communicating to students and perpetual quality in order to carry on the learning effort and build a context in which to use the language effectively, reduce anxiety and allow students to learn in a comfortable and pleasant state.

References

- Godwin-Jones, R. (2006). Tag clouds in the blogosphere: Electronic literacy and social networking. *Language Learning and Technology*, 10(2), 8–15.
- Petersen, S. A., Divitini, M., & Chabert, G. (2008). Identity, sense of community and connectedness in a community of mobile language learners. *ReCALL*, 20(03), 361–379.
- Sun, Y. C. (2010). Developing reflective cyber communities in the blogosphere: A case study in Taiwan higher education. *Teaching in Higher Education*, 15(4), 369–381.
- Ming, T.S., Ling, T.S., & Jaafar, N.M. (2011) Attitudes and Motivation of Malaysian Secondary Students towards learning English as a Second Language: A Case Study. *The Southeast Asian Journal of English Language Studies*, 17(1), 40 – 54.
- Hashima, I., & Samsudinb, S. (2020). Practices of Problem-Based Learning (PBL) In Teaching Islamic Studies in Malaysian Public Universities. *International Journal of Innovation, Creativity and Change*, 11(10), 117-129.

GAMIFY LEARNING FOR SUSTAINABLE SCIENCE STUDENTS THROUGH ESCAPE GAME BASED

Nurul Syazana Abdul Halim

Universiti Malaysia Kelantan, Jeli, Malaysia
syazana@umk.edu.my

Nor Shahirul Umirah Idris, Muhamad Azahar Abas, Norrimi Rosaida Awang

Universiti Malaysia Kelantan, Jeli, Malaysia
shahirul@umk.edu.my, azahar.a@umk.edu.my, norrimi.a@umk.edu.my

Highlights: This article is about developing interactive learning material for environmental sustainability subject using gamification experience. The House of Future is built based on an escape game for sustainable science students. In this game, students need to escape from the house to a new place named Sustainable country. For this purpose, they need to find the secret book kept and guarded by the spirit of the house. They have to look for the spirit of the house and answer questions correctly to get the book. This educational game has successfully attracted and engaged the students in the learning process.

Key words: *gamification, sustainable science, escape games, educational games, genially*

Introduction

During this pandemic era, most educators face challenges in grabbing the student's attention and engaged them in the learning process. This is because distance learning does not have the social and emotional connection like in a regular classroom. Most students become inactive and less interactive. Thus, educators need to use other approaches to attract and motivate students to participate in learning.

Gamification incorporates game elements and game thinking in activities that are not games to engage people, motivate, promote learning and solve problems (Kapp, 2013). Many educators have successfully increased the student's motivation and achievement by implementing gaming elements in learning tools such as using badges, leader boards, progress bars and many more (Stott and Neustaedter, 2013). Although non-digital games were commonly used in education, but digital video games for higher education especially in Malaysia are still lacking. Most educators are not familiar with gamification and do not have a background in animation, software design, computer graphics or any related field.

Nowadays, there are many web-based tools such as Knowre, Minecraft: Educational Edition, Pear Deck, Classcraft, Genially, etc., that can be used to create and develop simple gamification for educational purpose. In this project, we have successfully created 'House of Future', an escape game based on environmental sustainability education.

The House of Future: Escape Game

The House of Future was invented with an engaging storyline based on an escape game using genially (Figure 1). Genially is an online platform to create animated or interactive content such as video presentations, interactive images, infographics, quizzes and gamifications. They are many templates to choose from with different categories, which are manageable and can be made quickly. Educators can also create their content from scratch using creativity and imagination. Furthermore, this tool is user-friendly and also available in a free version.

House of Future was created using one of the available templates and was modified according to our storyline. In the House of Future, a player is trying to escape from an extremely polluted world to another world known as a Sustainable country (Figure 1b). To move to a new world, the player needs to find a secret book guided by the spirit of the house. The spirit of the house will grant the book if the player manages to answer all questions correctly. The questions created were related to the environmental sustainability subject.

This escape game has positively impacted sustainable science students in the Faculty of Earth Science (FSB) of Universiti Malaysia Kelantan (UMK). It has created excitement among the students and motivates them to self-learning. According to Kingsley & Grabner (2015), Leaning (2015), Seaborn & Fels (2015) and Koivisto & Hamari (2014), the gamification features introduced in the learning environment has shown positive effects on student's engagement, motivation and overall performance.

The invention of this escape game is helpful to engage and interact with students during online learning. Still, it can be further used as a module for environmental education and valuable material for the interactive campaign in educating sustainability concept to the public. Due to students' benefits and positive feedback, this project is undergoing improvement and development into various games based on environmental sustainability topics. We believe that this product could benefit the public and can be commercialized as an educational game for the community to raise awareness of environmental sustainability.



Figure 1: The interface of House of Future (a) and the mission of the game (b).

Acknowledgement

We are grateful for the Centre for Academic Excellence and Development of UMK for providing the technical support and training programmes.

References

- Kapp, K. (2013). *The gamification of learning and instruction fieldbook: Ideas into practice*. N.Y. : Wiley.
- Kingsley, T. L. & Grabner-Hagen, M.M. (2015). Gamification: Questing to integrate content, knowledge, literacy, and 21st-century learning. *Journal of Adolescent & Adult Literacy*, 51-61.
- Koivisto, J. & Hamari, J. (2014). Demographic differences in perceived benefits from gamification. *Computers in Human Behavior*, 35, 179–188.
- Leaning, M. (2015). A study of the use of games and gamification to enhance student engagement, experience, and achievement on a theory-based course of an undergraduate media degree. *Journal of Media Practice*, 16(2), 155-170.
- Seaborn, K. & Fels. (2015). Gamification in theory and action: A survey. *International Journal of Human-Computer Studies*, 74, 14-31.
- Stoff, A and Neustaedter, C. (2013). Analysis of Gamification in Education. Technical Report 2013-0422-01, Connections Lab, Simon Fraser University (unpublished material) <http://clab.iat.sfu.ca/pubs/Stoff-Gamification.pdf>

TAX KIT: I'M A JUNIOR TAX AGENT

Muhammad Zamrin Bin Maliki

Politeknik Sultan Haji Ahmad Shah
 zamrin@polisas.edu.my

Wan Azilah Binti Wan Yunus

Politeknik Kota Bharu
 azilah@pkb.edu.my

Highlights: Tax kit: I'm a junior tax agent, is an innovation that provides an overview of the tax process, from the original document to the filling of the tax form. These tax kits were first distributed in the form of printed documents to students. To accommodate the current scenario, the tax kit was modified into a flipbook for the June 2020 session. To facilitate data sharing with students, the QR code method is used to save costs and time. To date, four polytechnics have used these tax kits as teaching and learning materials. This tax kit has the potential to be shared with other polytechnics, IPTA and IPTS, as one of the teaching and learning tools.

Keywords: Tax kit, Original Document, tax form, QR code, Flipbook

Introduction

The use of teaching aids in the Teaching and Learning process (TnL) is important to ensure that teaching can be delivered clearly and meet the needs of the current curriculum. The integration of technology in education has not only changed how students learn but has also changed the teaching pedagogies by promoting collaborative activities (Haddad, 2003). Innovation in education needs to follow the changing world and solve educational problems effectively (Whattananarong, 2011). Therefore, it is crucial and indispensable to create good quality innovation, Sintapanon (2009) mentioned that creating innovation in education is vital for learning because it helps learners understand content and lesson clearly. A good innovation must be able to attract students, save in terms of cost and time towards the development of the latest technology.

Tax Kit: I'm A Junior Tax Agent is an innovation in Teaching and Learning (T&L) that can stimulate students in solving problems found in case study questions of the course DPA5033 Malaysian Taxation 2. In addition, it can be used as a training kit for accounting diploma students before undergoing industrial training to strengthen their understanding of taxation. This tax kit may provide a complete overview of the preparation of tax documents from the original documents.

Students are exposed to documents related to tax assessment for individuals as opposed to the use of structured essay questions previously. Therefore, the Tax Kit: I'm A Junior Tax Agent is produced and distributed to students to make them more familiar with and familiar tax documents. Along with the circulation of technology, this innovative product has been enhanced with the production of interactive kits using FlipHTML5 software in line with paperless & data sharing methods in various matters. Furthermore research conducted by Simatupang & Sormin (2020) stated the use of flipbooks as a learning medium can improve students learning outcomes and skills.

Description of innovation

	DECEMBER 2018 – DECEMBER 2019	JUN 2020 - NOW
PLAN	Provide tax training kits in the form of document files until the completion of tax forms (printed material) to fifth semester students of diploma in accounting. Tax planning elements are included in this tax kit.	Convert tax kits to digital flipbook form using FlipHTML5 software in line with the new learning norms post Covid-19 online learning. The use of videos from YouTube is used to replace the Seminar function to explain the planning process and fill out income tax forms.
DO	Printed materials are given to students during tax simulation workshops/seminars.	This taxation kit is used as a case study material for continuous assessment for the course DPA5033 Malaysian Tax 2. To facilitate access to this tax kit, a QR code and access link FlipHTML5 Tax Kit: I'm a Junior Tax Agent.
STUDY	From the questionnaire form given to the students, this tax kit can provide a true picture of tax preparation, from the original document to the filling out of the tax form. In addition, it is also able to increase students' confidence in personal tax computation.	
ACT	The use of taxation kits has to be expanded not only in Case Study assignments but also in Teaching and Learning (TnL) sessions.	

Background of innovation

The Tax Kit: I'm A Junior Tax Agent is an innovation in teaching and learning (TnL) produced to facilitate lecturers and polytechnic students who take the Malaysian Taxation 2 (DPA5033) course which is compulsory course for students majoring in a Diploma in Accounting (DAT). This innovation was created to facilitate students in completing case study assignments for this course. Case study assignments require students to solve problems related to tax planning in aiming to minimise tax payments without violating legal provisions.

Students are exposed to documents related to tax assessment for individuals. Therefore, the Tax Kit: I'm A Junior Tax Agent is produced and distributed to students so that they better know and understand tax documents. Along with the circulation of technology, this innovative product has been enhanced with the production of interactive kits using FlipHTML5 software in line with paperless & data sharing methods in various matters. In a world of rapid change in information and communication technology, innovation in education needs to keep updated and get prepared for this changing world in order to solve educational problems effectively (Whattananarong, 2011).

Important of innovation

- i. Improving the effectiveness of teaching and learning where students' comprehension can be improved through the use of visuals and graphics.
- ii. Make the documentation used in income tax assessment more transparent to students. This aims to give students the experience to calculate taxes starting from the original document. Experiential learning or learning by doing requires that students are actively involved in the learning process. The key element in experiential learning is an emphasis on the centrality of experience and reflection on experience to the learning process (Kolb 1984).
- iii. Facilitate the sharing of teaching materials in the teaching and learning process of taxation with Malaysian polytechnic lecturers.

Advantages of innovation

- i. **Easily accessible** - The tax kit is easily accessible using a computer or smartphone via a link or QR code provided and does not require large storage space, under the concept of data sharing. The arrangement of relevant documents also facilitates access to the kit. According to Seechalio (2017) nowadays, learning behaviours have changed, they like to learn with social media and mobile devices.
- ii. **Visual and graphic** - The use of visuals and graphics attracts interest and makes it easier for students to use this tax kit. It has provided good stimulation for the TnL process.
- iii. **Better understanding** - This tax kit can provide a clear picture of the taxation process from the original document to the filling of the tax form and is linked to what was learned in class.
- iv. **Cost saving** - Save on printing costs by using the flipbook method. Learners believed that social media could save time and money for online courses (Seechalio, 2014).
- v. **Disseminated** - The use of a flipbook allows this tax kit to make it easy to share with those who teach the same course at different polytechnics.

The commercial value of innovation

- i. This tax kit can be shared with other polytechnics. For now, this tax kit has been used in four polytechnics, namely in Politeknik Sultan Haji Ahmad Shah, Politeknik Kota Bharu, Politeknik Hulu Terengganu and Politeknik Muadzam Shah.
- ii. This tax kit has been agreed to be used as teaching and learning material by Mara Kuantan Professional College(KPM) for the September 2021 session, demonstrating that the tax kit has the potential to be shared with IPTA and IPTS as teaching and learning materials.
- iii. The tax kit provided is included with the user manual and it is user-friendly.
- iv. The cost of implementing the tax kit in the teaching and learning process is cheap.

Acknowledgment

Thank you to our family, colleagues, and students for the support and feedback provided while implementing this tax kit. Thank you also to the tax lecturers at Politeknik Hulu Terengganu and Politeknik Muadzam Shah for their willingness to use this tax kit as a teaching and learning tool as well as provide constructive comments to improve this tax kit.

References

- Ahmad, A., Abdul Razak, A., & Md Salih, N. *Malaysian Taxation II*. Pulau Pinang: Azimat Advance Ventures
Ali, W (2020). Online and remote learning in higher education institutes: A Necessity in light of COVID-19 pandemic. *Higher Education Studies*, 10(3), 16-25.
Cheng, A. (2020). *Malaysian Taxation* (34th ed). Kuala Lumpur: YSB Management Sdn. Bhd.

**SOCIAL INNOVATOR TALENT DEVELOPMENT INNOVATIVE FRAMEWORK: CERTIFIED SOCIAL
ENTREPRENEURIAL INNOVATOR PROGRAM**

Wan Mohd Nazdrol bin Wan Mohd Nasir

Universiti Malaysia Kelantan, Malaysia
nazdrol@umk.edu.my

**Siti Aishah Attaullah, Nik Zulkarnaen Khidzir, Jayaraj Vijaya Kumaran, Nik Maheran Nik Muhammad,
Mohamad Izharullail Azmi**

Universiti Malaysia Kelantan, Malaysia
sitishah@umk.edu.my, zulkarnaen.k@umk.edu.my, jayaraj@umk.edu.my, nikmaheran@umk.edu.my,
izharlail@gmail.com

Highlights: The Certified Social Entrepreneurship Innovation (CSEI) Program was designed to certify social innovators through the four levels of evaluation. Each level will measure the criteria for social innovation including the ideas and action plans. During the four levels of evaluation also, the participant was exposed with adequate knowledge and exposure on the reality of social entrepreneur. Being an entrepreneur is a challenge, but the basic guideline is available. However, being a social entrepreneur was not much debated which left many rooms to be improved. Thus, CSEI is a program to prepare an entrepreneur to become a social entrepreneur.

Key words: *Social Entrepreneur, Social Innovation, Cybergogy Approach, CSEI Framework.*

Introduction

Social Innovation is the process of developing and deploying effective solutions in pertaining to social and environmental issues. The solutions often require the active collaborations of constituents across government, business entity, non-profit organization (NGO) and community. It is very essential to encourage more entrepreneurs to become social entrepreneur and engage in social innovation for better society development. CSEI program was developed to improve social entrepreneurship training programme effectiveness and to certify both mentor (lecturer) and mentee (students) in order to develop an innovation that able to provide an alternative solution for social or environmental issues. Moreover, training programme provided will encourage more interest to social innovation project through talent development and structured experiential training programme. Thus, CSEI is a program to develop a social entrepreneur by recognizing their interest, effort and attitude by eliminating those who only loves the idea of being a social entrepreneur but actually do not have the passion to become one. Level 1 (Associate) is the idea generation stage. A few videos were sent to mentor and mentee (also referring as participants) for them to get the basic ideas of social innovation and to gain their own ideas. They are also requested to answers a set of multi choice questions (MCQ) on social innovation, entrepreneurship and social entrepreneurship. Those with 75% of correct answers will continue to the next level. Level 2 (Practitioner) was proceeded with business model canvas (BMC) and project description. The BMC used was tailored with social innovation purposes and not the regular BMC for business ideation. This stage is very crucial for mentor and mentee to know the elements of social innovation that they get involved. As for project description, participants need to understand the sustainable development goals (SDGs) that they want to address and their target group. Thru these BMC and SDGs evaluation, the participants were given comments and suggestions to proceed to the next level. Level 3 (Professional) is the business proposal. Once they reached this stage, both mentor and mentee have already identified their social innovation and working together to establish their business proposal (based on BMC and SDGs conducted). The business proposal then was evaluated according to the tailored made rubrics and examples that has been formulate according to the "Beehive" modules that have been developed and certified internationally. The last stage or level 4 (Coach) involve business pitching which was conducted online. Thus, it is suggested that the CSEI framework established was using cybergogy approach to cater the participants that physically scattered during the pandemic Covid-19. The cybergogy approach also is considered as the innovation in social innovation education which is currently adapted in this project.



Acknowledgement (if any)

We are grateful for High Impact Grant by Malaysia Ministry of Higher Education for this framework commercialisation. Special thanks to Wow Labs and US Embassy for the funding of Beehive project that has led us to the establishment of the social entrepreneurship's modules.

References

- Ahmad, A., Abdul Razak, A., & Md Salih, N. *Malaysian Taxation II*. Pulau Pinang: Azimat Advance Ventures
- Ali, W. (2020). Online and remote learning in higher education institutes: A Necessity in light of COVID-19 pandemic. *Higher Education Studies*, 10(3), 16-25.
- Cheng, A. (2020). *Malaysian Taxation* (34th ed). Kuala Lumpur: YSB Management Sdn. Bhd.
- Haddad, W. D. (2003). Is instructional technology a must for learning? Retrieved from http://www.techknowlogia.org/TKL_activepages2/CurrentArticles/main.asp?IssueNumber=19&FileType=HTML&ArticleID=455
- Kolb, D. A. (1984). *Experiential learning: experience as the source of learning and development*. Englewood Cliffs, NJ: Prentice-Hall
- Seechalio, T (2014). Lecturers' behaviours and beliefs regarding social media in higher education at the Faculty of Education, Mahasarakham University. *Journal of International Education Research*, 10(2), 155-160
- Seechalio, T (2017). Instructional strategies to support creativity and innovation in education. *Journal of Education and Learning*, 6(4), 201-208
- Simatupang, I. N., & Sormin, E. (2020) The effectiveness of using flipbook maker to improve the chemistry learning outcomes of senior high school students. *Jurnal Pendidikan Kimia*, 12(1), 26-33. <https://doi.org/10.24114/jpkim.v12i1.17710>
- Sintapanon, S. (2009). *Educational innovation to develop youth's quality* (3rd ed). Bangkok, Thailand: 9119 Technic Printing.
- Whattananarong, K. (2011). *Innovation and technical education technology*. Bangkok, Thailand: King Mongkut's University of Technology North Bangkok.

SPEAKING SQUARES

Siti Martini binti Mustapha

Politeknik Kota Bharu, Kelantan, Malaysia
sitinajman@gmail.com

Rosilawati binti Muhamad Ramli, Zarina binti Hashim, Noor Hafiza binti Zainuddin, Rodey Hamza bin Hamzah

Politeknik Kota Bharu, Kelantan, Malaysia
rosilawati@pkb.edu.my, zarinahashim@pkb.edu.my, hafiza@pkb.edu.my, rodeyhamza@pkb.edu.my

Highlights: Speaking Squares is a board game that is inspired by snake and ladder game. This board game is designed to develop and improve English language speaking skills of English language learners. This game comes with five sets of questions that focus on building learners' knowledge and skills in language forms and functions. Each set has twenty-five questions based on various language functions and twenty penalty questions. It can be played with at least two players. Speaking Squares is handy, practical, fun and interesting game which will likely enhance speaking skills and eventually promote English language learning through a non-threatening environment.

Key words: *language game, speaking skills, English language learners*

Introduction

Polytechnic Malaysia has an important role in producing competent, dynamic and competitive workforce to the nation. With the Polytechnic Transformation Plan (2010-2015), Polytechnic Malaysia aims to produce human capital with first class mentality who is knowledgeable and skillful so as to meet market demands (Nordin, Rahmanzai and Buang, 2012). One of the crucial skills that is needed for a graduate to be competitive is being proficient in English language. This is because English language is perceived as an essential employability skills by employers in Malaysia, so graduates who are able to communicate well in English are likely to get employed (Ting et al. 2017). Due to the market demands, building learners' communication skills and confidence in speaking in English language has become an integral part in the English language classroom landscape in all polytechnics in Malaysia.

Realising the impact of English language proficiency as a crucial employability skill, the Communicative English syllabi for Malaysian polytechnics aim to develop students' oral communication skills in English so that they can use the language confidently (Hashim and Isa, 2012). Hence, building learners' communication skills and confidence in speaking in English language has become an integral part in the English language classroom landscape in all polytechnics in Malaysia.

However, many polytechnic students still have problems speaking in English as reported in many studies such as Hashim and Isa (2012), Singh et al. (2019) and Mohamad (2020). Most of the time, they show lack of confidence when speaking in English which is due to the low proficiency in the language. As such, they tend to struggle when speaking in English (Mohamad, 2016).

Studies have shown that language games bring positive impacts to language learners as they provide both challenge and entertainment to the language learning experience (Ibrahim, 2017). Language games such as board games are useful tools to improve the speaking skills of low-proficiency learners as they become more confident and more willing to speak (Yong and Yeo, 2016). Therefore, Speaking Squares is designed as a tool to promote speaking skills, and eventually their oral communication skills, among students through a fun, exciting and interesting game in a non-threatening environment.

Description of Speaking Squares

Speaking Squares is inspired by snake and ladder game. However, there are a lot of differences between the two games. While snake and ladder game only focuses on the fun aspect, Speaking Squares, on the other hand is designed to improve students' speaking skills in English which will eventually promote effective communication skills through a fun learning environment. The questions in this game are based on the Communicative English language syllabi of Malaysian polytechnics. Speaking Squares creates a learner-centred experience to learning where the students play an active role in the learning process and the lecturer becomes a facilitator to facilitate learning.

Speaking Squares is a practical, handy, flexible and fun board game that is designed to develop polytechnic students' speaking skills. It is light and can be carried anywhere. It comes in five sets which are indicated by different colours. Each set of questions consists of 25 questions that are based on the three Communicative English syllabi that are taught at polytechnics in Malaysia which focus on language forms and functions. To add fun to the game, there are also twenty penalty questions that range from tongue twisters, grammar and vocabulary. The grammar and vocabulary questions would enable learners to increase their knowledge in English language, while tongue twisters help to improve their pronunciation. To play the game, there should be at least two players. The players will throw dice and proceed with the game until they reach the finishing.

Background of the innovation

English language teaching in polytechnics in Malaysia generally aim in producing learners who confident users of English and are able to express themselves well in the language. However, many studies indicate that the reality in most English language classrooms in the polytechnics show quite a different story. As a lot of the learners have low proficiency in English, they tend to have lack of confidence when asked to speak in the language. This is evident in their oral presentations and mock job interviews. Therefore, in order to help the students eliminate their shyness in speaking in English, language games seem to be the most potential tool to be used for this purpose. The impacts of language games to help increase learners' confidence and enhance communication skills have been discussed in numerous studies such as Yong and Yeo (2016) and Ibrahim (2017). As such, considering the impacts of language games in language teaching and learning, Speaking Squares are designed with the aims to improve polytechnic students' speaking skills in English so that they eventually become confident speakers in English, at the same time enhanced their grammar and vocabulary.

Significance to education

English language learning can be stressful to many students especially those with low-level proficiency in English. Therefore, Speaking Squares is potential to be used as a learning tool to create a positive and fun language learning atmosphere in the classroom. When students play the game, the interactions that they have with each other will enable them to learn English in a more relaxed environment, and will therefore make them see the language in a more positive way. Eventually, with the support that they get from each other as they are attempting the questions will increase their confidence to use English.

Advantages

Speaking Squares is a language learning tool that can be used to promote speaking skills among low proficiency students. As students have to answer the questions in the game, they will indirectly learn the language. The interaction that the students have with each other as they are playing the game will likely to encourage them to speak in English. As a result, it helps to increase their confidence to speak in English. Another advantage is that it is a fun and interactive game which is an important in making a positive learning environment. Through this game, students who are shy and have low level of confidence in speaking in English will have the opportunity to work with each other in order to win the game and bulding the communication skills along the way. Apart from that, it is a practical board game that is flexible as it can be used for many language learning purposes and adaptable for different groups of learners. Speaking Squares can be used both as an enhancement and enrichment activity.

Commercialisation

Speaking Squares is marketable as it can be used by all types of learners who are not just polytechnic students but also other learners in other institutions such as community colleges, ILP, IKBN and even schools as both enhancement and enrichment activities. It is also a low-cost game. The materials used are very affordable so it can be reproduced by the lecturers without having to worry about the budget. Apart from that, it can be reproduced easily and the questions can be changed to adapt to different needs of the students. It also does not require special tools to play which makes it practical and handy.

Acknowledgement

We are grateful for this opportunity to create something that is beneficial to our students.

References

- Hashim, H. & Isa, I.S.M. (2012). Students' anxiety level towards speaking in English: Malaysia polytechnic experience. In *IEEE Symposium on Business, Engineering and Industrial Applications*, pp. 595-599. Piscataway, NJ: IEEE.
<https://doi.org/10.1109/ISBEIA.2012.6422957>
- Ibrahim, A. (2017). Advantages of using language games in teaching English as a foreign language in Sudan basic Schools. *American Scientific Research Journal for Engineering, Technology, and Sciences (ASRJETS)*, 37 (1), pp. 140-150.
- Mohamad, M. (2016). Enhancing English proficiency among polytechnic students: promoting autonomous learning. *Journal of Applied Environmental and Biological Sciences*, 6 (8S), pp. 49-57.
- Mohamad, M. (2020). Investigating second language anxiety among polytechnic students. *International Journal of Academic Research in Business & Social Sciences*, 10 (7), pp. 632-637.
- Nordin, H., Rahmanzai, A.M. & Buang, N. (2012). 'The impact of technical and vocational education and training programs offered by polytechnics on Malaysian economic development based on the graduates' job performance'. *International Conference on Vocational Education and Training (ICVET) 2012*, pp. 212-218.
- Singh, C.K.W., Singh, T., Ja'afar, H., Hoe, T.W., Subramaniam, G.J. & Hong, M. (2019). Developing a prototype speaking game for Engineering students at polytechnic in Malaysia. *Journal of Engineering Science and Technology*, June 2019, pp. 9-17.
- Ting, S.H., Marzuki, E., Chuah, K.M., Misieng, J. & Jerome, C. (2017). Employers' views on importance of English proficiency and communication skill for employability in Malaysia. *Indonesian Journal of Applied Linguistics*, 7 (2), pp. 315-327.

THE "RADIO OF TAFSIR QURAN": UNDERSTANDING TAFSIR QURAN THROUGH INTERACTIVE GADGET

Shamsul Kamal bin Abdullah @Mohd Khir
Politeknik Kota Bharu, Kota Bharu, Malaysia

ust.sham@gmail.com

Roslan bin Yahya, Alinawati bt Ab Aziz@Kamarulzaman, Rasidah bt Md Nor, Mohd Zohdi bin Said

Politeknik Kota Bharu, Kota Bharu, Malaysia

roslan.hep@gmail.com, alinawatiabaziz@gmail.com, rasidahmn@gmail.com, mzohdi56@gmail.com

Highlights: The Quran should be made understandable to all Muslims since it is the main source of reference in our life. Without understanding it, we will stray far from the path of Islam especially in this modern and the busiest world. The aim of this invention is to create an interactive and easier ways in delivering the verses of Quran using 'Radio of Tafsir Quran'. The unique feature of this invention is the modification that has been made to the radio's SD card so that the users (students) able to listen to the interpretation of any surah or verse in the Quran by pressing the numbers provided in the guidebook. This application is also easy to be carried anywhere and to be used especially for the lecturers and students in Science Technology in Islam course. In our polytechnic, the pre and post evaluation to determine the usability of this "Radio of Tafsir Quran" will be conducted among lecturers in the Department of General Studies as well as among our semester 2 students. This interactive application is essential to assist students to understanding Islamic teaching and syllabus even outside their formal classes.

Key words: *Radio, Tafsir Quran, easy tool, interactive gadget*

Introduction

Innovation or tajdid in Arabic is an importance and necessity because the sunnah of life is very much in need of it (Majali, 2014). The need for innovation is something that is inevitable and is an important factor for the development of the 21st century. Innovation contributes to various aspects including knowledge and education which are known to be important factors for a more competitive and dynamic country.

Innovation in knowledge and education should be emphasized so that human beings can act effectively to change lives and should also focus on the types of knowledge needed by Muslims today as well as changes in teaching and learning methodologies. In response to this development, we, the lecturers of the Islamic Education Unit, Kota Bharu Polytechnic, are called to produce an innovation that is "understanding the Qur'an in a Relaxed and Interactive manner through Radio Tafsir al-Qur'an. Through this application the user is easy to understand the meaning and listen to the description of the interpretation of any surah or verse in the Qur'an by pressing the numbers that have been provided in the guidebook. The application is also easy to carry anywhere and facilitates students, especially semester 2 students who take Islamic Science Technology and Engineering (STK) and Islamic Studies courses as well as lecturers who will be the main platform to educate a superior generation and a knowledgeable society.

Content

1. Description of innovation / product development / design / process.

1. Collecting all materials for the interpretation of the Qur'an 30 juzu 'talaqqi bersanad by alfadhil Maulana Hj Abdul Hadi bin Haji Yaakub Mudir Pondok Darul Uloom Laklok Jerih Terengganu.
2. The process of converting daurah tafsir video to MP3.
3. Create a register serial number for each lecture for an interactive application process.
4. All materials are stored in the SD Card in the order that has been planned
5. Test run product innovation.
6. Provides simplified code to use reference sheet.
7. The process ended and was successfully used.

2. Context or background of the innovation / product development / design / process.

1. Difficulty students read and understand the verses in the Qur'an.
2. To understand the al Quran needs an interpretation of those skilled in the interpretation.
3. Challenge the process of teaching and learning when pandemic requires a method that is more effective because of its method of face to face cannot be executed.
4. Students are less interested in learning the Qur'an because it is considered something heavy and difficult.
5. People away from religion because, far from the Al-Quran education real

3. Important to education

1. Produce a product that can assist the students understand the contents of the Qur'an.
2. Educating students to always accompany the Qur'an.
3. Encourage and interest students to memorize the verses of the Quran.
4. To make Radio Tafsir Al Quran one of the Teaching Aids (ABM) for lecturers.
5. Help the community understand and memorize the verses of the Quran easily and effectively.

4. Advantages of innovation / product development / design / process towards education and community.

USING RADIO TAFSIR AL QUR'AN	Interpretation LEARNING IN ORDINARY
1- Just need to press the numbers that are arranged directly to be able to hear the interpretation easily.	1- Need to open a physical book, or in a gadget.
2- Easy to carry and can listen to tafsir anywhere.	2- Physical book difficult to carry out seeking a place to learn and limited interpretation.
3- Triggers interest and motivation to live up to the meaning and interpretation of the Qur'an.	3- Motivation (in the usual form less motivated to study)
4- Can be used in a flexible time, anywhere, place or situation, plug and listen.	4- In the conventional constraints of time, usually to a specific time
5- Ability owned by society.	5- High price to get an authoritative interpretation
6- Able to complete the study of tafsir in a short time.	6- The usual method is quite possible to spend learning the interpretation of the 30 constituents in a short time
7- Learning in a relaxed (not depressed) A new form of learning.	7- Bit stressed and need to focus on the full

5. Commercial value in terms of marketability or profitability of your innovation / product development / design / process if any.

- ❖ DESIGN: Modern, simple, practical and more attractive shape and design. It is available in a variety of attractive colour options.
- ❖ SMALL AND LIGHT WEIGHT: Small and light weight. Easy to carry anywhere and installed no matter the time.
- ❖ SAVE: This radio comes with a special rechargeable battery. The battery only needs to be charged and can last more than 8 hours of continuous use. It also does not require an internet data.
- ❖ MISCELLANEOUS FILL: Contains more than 900 ++ charging audible helpful and appreciated easily at any time.
- ❖ AUDIO HIGH QUALITY: Equipped with a high-quality audio system, melodious, clear and bright reading. Adjustable audio volume to suit the space and the audience.
- ❖ USER FRIENDLY: Very easy to use. To listen to the interpretation of chapter selection, simply press the number on the radio according to the instructions that we have prepared.

References

- Adhalina, N. (2011). The Different Language Style and Language Function Between Students and Teachers in Updating Their Status in Facebook Webpage (A Case Study of the Topic National Final Examination 2011) (Doctoral dissertation, University of Diponegoro).
- Alessandra, A. J., O'Connor, M. J., & Van Dyke, J. (1994). People Smarts: Bending the Golden Rule to Give Others what They Want. Pfeiffer.
- Mohammad Khazer Al-Majali. (2014). Hajah al-Dirosat al-Quraniyyah ila al-Tajdid wa Dhawabituha. Seminar Tajdid in Quranic Studies. Universiti Malaya.

PARCEL STORAGE BOX

Afiqah Natrah Binti Shaharudin

Politeknik Kota Bharu, Kota Bharu, Malaysia
afiqahshaha16@gmail.com

Nur Aliya Nadhirah Binti Shamsunaha, Siti Aisyah Binti Zulkifli, Wan Nur Anis Hidayu Binti Wan Zailani, Aida Ashyurani Binti Mohd Razully

Politeknik Kota Bharu, Kota Bharu, Malaysia
aliyanadhirah00@gmail.com, sitiaisayahzulkifli00@gmail.com, anishidayuzailani@gmail.com,
ashyuraniaida@gmail.com

Highlights: The "Parcel Storage Box" is a one-of-a-kind design that solves the problem of receiving packages while the owner is away from home. There has been an increase in internet purchases as a result of the Movement Strict Order (MCO) imposed as a result of the pandemic Covid-19. "Parcel Storage Boxes" are convenient and simple to use by both couriers and recipients because they do not need to touch each other in order to receive the parcel, in accordance with physical distancing rules. This parcel is made of Oriented Strand Board, a weather-resistant material that can be used for a longer period of time. Furthermore, the safety lock makes it more secure.

Key words: Parcel, Covid-19, courier, online, Oriented Strand Board (OSB), safety

Introduction

Recipients and couriers frequently encounter issues when receiving and shipping goods online. This is due to the recipient's absence from home, which creates a challenge for the sender and slows down the process of receiving the goods. It will also be inconvenient for the recipients because they will have to travel to the goods collection centre. Sometimes, the courier places the goods outside the fence, on the fence wall, or throws them into the house fence. Some of their belongings have been damaged or broken as a result of the situation.

The researchers created the "Parcel Storage Box" after conducting extensive research and surveying courier riders. This box incorporates Oriented Strand Board (OSB) as an innovation to prevent defects caused by weather or animals.

Content

1. Description of the innovation

The main materials used for product development are Oriented Strand Board (OSB), nails, lock Mbox, door handles, wooden screws and door hinges. Three Oriented Strand Boxes (OSB) are being joined together to form a product frame and attached with wooden glue. Then, all parts of the frame are fixed with 1 "wooden nails. The process is repeated again to build the front frame. The door hinge is drilled at the top of the door (product roof). The privilege of the "Parcel Storage Box" is that when the courier puts the parcel at the top door, the parcel will automatically go down and be locked, and it can prevent thieves. Figure 1 shows the Oriented Strand Board (OSB) to produce a "Parcel Storage Box".



Figure 1 Oriented Strand Board (OSB).

2. The context or background of innovation

A total of 40 courier riders took part in a survey to determine the issues they encountered while delivering packages. The majority of respondents (20) agreed that it is difficult to deliver an item when the recipient is not at home. The majority of respondents (37 respondents) responded that they must call the receiver and wait for them to collect the parcel, while (12 respondents) agreed that the safety of the parcel while being delivered is critical.

The "Parcel Storage Box" is an innovative product designed to make the sender's job easier by storing the recipient's goods in the "Parcel Storage Box." The recipient's goods will be safer with this "Parcel Storage Box" because they will be protected from rainwater, wild animal bites, and other potential hazards. The "Parcel Storage Box" is essential for

recipients who are frequently away from home or recipients who frequently travel to outstations. As a result, it will make the work of both parties, namely the receiver and sender, easier. This not only improves the ease of receiving goods, but it also saves time for both senders and recipients. Furthermore, if consumers do not have time to receive their goods at home, they do not have to rush to pick them up at the goods collection centre.

3.The importance of this innovation to education

This innovation is important to our educational system, particularly for students studying entrepreneurship. It has the ability to cater to the practical demands of a specific group of students. The student was able to adjust to practical situations and did not solely rely on theory in class.

4.Advantages of the innovation towards education and community

This project innovation can help students achieve Polytechnic's vision of producing holistic, entrepreneurial, and well-rounded graduates. Students who participate in competitions can learn how to put what they've learned in business project class into practice and how to become entrepreneurs. Students are capable to contribute to the society and courier industry in Malaysia by creating this innovation. This product can be used by society to solve problems with receiving parcels and by the courier industry to save time when delivering parcels.

5.Commercial values in terms of marketability and profitability of the innovation

The cost of prototyping a "Parcel Storage Box" is low. If a product is manufactured in large quantities, the price may fall. Residents can use the "Parcel Storage Box" to save time by delivering parcels without worrying about the safety of the parcel while being left, and the receiver does not need to pick up the parcel at the collection center. The researchers hope to promote the Parcel Storage Box through online shopping platforms like Shopee, Lazada and social media platforms like Facebook and Instagram. Target market is for local and international market. Product features will be improved in terms of safety to meet consumer demands. Many people nowadays are drawn to modern design when it comes to home decoration. The "Parcel Storage Box" can be used as a piece of home decor.

Acknowledgement

We are grateful to Madam Juli Suzlin binti Jalaludin (as the Course Coordinator) and Madam Aida Ashyurani Binti Mohd Razully (as supervisor) for their guidance and support which enable us to complete this project successfully.

References

- Jacek Karcz and Beata Slusarczyk from Czestochowa University of Technology, (2016), Improvements in the quality of courier delivery. Retrieved from, https://www.researchgate.net/publication/307832317_Improvements_in_the_quality_of_courier_delivery
- Muhammad Ashlyzan Razik from University of Malaysia Kelantan, (2017), The Determination of HEP Parcel Service Quality toward Student Satisfaction. Retrieved from, https://www.researchgate.net/publication/318851455_The_Determination_of_HEP_Parcel_Service_Quality_toward_Student_Satisfaction_in_Malaysian_UniversityUMK_campus
- Norlena Hasnan, Alminnouriza Noordin and Nor Hasni Osman from Universiti Tun Hussein Onn Malaysia, (2014), Six Main Innovation Issues: A Case of Service Innovation of Postal and Courier Services in Malaysia. Retrieved from, <https://publisher.uthm.edu.my/ojs/index.php/jtmb/article/view/910>

A MOTIVATION VIDEO: YOU CAN DO IT!
A SHORT VIDEO IN DEVELOPING TECHNICAL STUDENTS TO LOVE ENGLISH LANGUAGE

Che' Fadhilah Binti Che' Lah

Politeknik Kota Bharu, Kelantan, Malaysia
chefadhilah@pkb.edu.my

Shuzura binti Yusof

Politeknik Kota Bharu, Kelantan, Malaysia
shuzura@pkb.edu.my

Highlights: The innovation of communication and technology has played an important role in developing English language proficiency among technical students nowadays. By using an interesting video on learning English will make of video's potential for the students to catch the content in their courses. Most of the students learn English is just for the sake of the final examination. So, there are not able to produce even a simple sentence. In this situation, it makes all teachers feel bad and pity to their students. Just watching this fun video and the students will have courage to speak up with their teachers and friends. There are some practical tips on how to learn English well throughout this short video because during Covid-19 pandemic all classes should take an online lesson and the students must have enough sources to enjoy their lesson of that day which engage the students to updating their context of technical knowledge. This simple video also designed to provide students with effective presentation skills as their preparation for academic and work purposes after completing their study soon. The end of this video, we are hoping all students to have the ability to communicate confidently and effectively. In a nutshell, the importance of English cannot be denied anymore since English is the greatest common language spoken universally by all people in this world. Video is a fun element to use, and most significant of all, the students feel that it is a new and having more interest to open eyes and learn this second language as a language of victory.

Key words: *communication, English, language, world*

Introduction

Nowadays, learn English would be in the fastest, easiest and most fun way because technology brings with simple design and information to all students. There are 3 major benefits by watching this innovation video. The first main point is enhanced vocabulary skills are crucial for personal and professional development. Using high-quality and complex words can take your career to new heights.

Watching English videos are a great way to improve your vocabulary in a fun and entertaining way. You get exposed to new and unique words every day. Children are often encouraged to play such games because of this reason. They get to learn high-level vocabulary and sharpen their skills. Playing English word games regularly will improve your linguistic skills. Next point is, to keeps students feel happier and healthier. They could playing these videos and watch it again and again to get through its content. This entire works can make them to be happy person while studying English subject. Yes, it is true. Researchers have found that it increases the production of dopamine in your brain and improves your mood. So, what exactly is dopamine? It is a neurotransmitter that makes you feel energetic, happy, optimistic, and satisfy. You must have felt the sensation of immense satisfaction when you solve a word puzzle. It is the dopamine being released in your brain. Just play a few word games on a daily basis to stay healthy and happy every day.

The last point that also important in bring back language acquisition is it's improves the students cognitive abilities meanwhile they are watching video-related education are well-known for having positive effects on your cognitive skills. The best point is by watching English language videos will help you identify and solve problems better. They enhance your ability to boost your creativeness and you will see positive results soon afterward especially videos that created such a courage and positive impact in learning English subject.

Content

1. Description of the innovation

There is an interesting of motivational video from our innovation. We are produce this wonderful video to promote an English subject for all semester one students in Communicative English 1 which being offer every semester in Politeknik Kota Bharu. All this latest video is full of learning process that suits with the need of language learners.

2. The context or background of the innovation

We are covering the PLO's known as Programme learning outcome that needs the technical students to communicate effectively on well-defined engineering community and with society at large, by being able to comprehend the work of others, document their own work, and give and receive clear instructions. Another PLO'S is to recognize the need for, and have the ability to engage in independent updating in the context of specialized technical knowledge.

3. The importance of this innovation to education

The motivational video called "You Can Do It!" is showing the important in today's education especially facing pandemic situation which allows all students and teacher to work at home. So, just click to the YouTube link and you can enjoy the simplest tips to learn English with easy ways.

4. Advantages of the innovation towards education and community

There are three advantages that our technical students could achieve after viewing our video. The first point is involving Cognitive skills: Cognitive skills will require the learners to understand English by learning through short videos and capture the main ideas and responding to it when they are ask to do some assessment or task soon. Then, the second point involving Affective skills that describe the affective skill involves feelings, attitudes and emotions while learners interact with the short video and catch some emotion towards the video. They even could repeat the video that they feel warmth and cosy to learn with. Just take your time to understand the video. The third point also important in learning process which involving Psychomotor Skills: It is an innovation video that requires psychomotor skills for the learners to aim for the communication skills tips and apply it in their daily. This innovation aims to create a holistic learning experience by incorporating all the three domains in learning: such as cognitive, affective and psychomotor.

5. Commercial value in terms of marketability or profitability of the innovation

Learning through motivational videos get reaches the vocabularies which improve students' language level. The students could also communicate in English confidently. The pages are organised by topic and include interactive exercises to help you learn and remember the new words. What kind of learning you do depends on what you are watching for. Here are some ideas to get you started: The first point is by watching for the language. Listen to the way vocabulary, grammar and phrases are used. Second point is watch for the people. Listen to the accents and slang. Watch for the difference between the way people speak, and what it tells you about their place in society. The last point is watching for the culture. People speak differently depending on where they're from. If the students are watching for the video then, they could feel much closer to use English languages everyday for the purpose of communication and build self-directing learning.

Acknowledgement

Special thanks to our Head of General Studies Department, En Roslan bin Mamat for his support and understanding. Also dedicated to our Head of Commerce Department, Pn Rosilah binti Wok for her caring and supporting. We also want to express a deep sense of gratitude to all CRI team members at Politeknik Kota Bharu for monitoring our project until success.

References

- Alauyah, J. & Bawani, S (2016). Developing Reading Skills. Oxford Fajar Bakti Sdn.Bhd
- Conrad, D. & Openo, J. Assessment Strategies for Online Learning: Engagement and Authenticity (Athabasca Univ. Press, 2018).
- Hodges, C., Moore, S., Lockee, B., Trust, T. & Bond, M. A. The difference between emergency remote teaching and online learning. Educause Review <https://go.nature.com/38084Lh> (27 March 2020).
- Kathryn, SY. & Howard, P.T. (2018). Oral Communication: Skills, Choices & Consequences (4th Ed.). Waveland press,
- Koch, A., Schmitt, J. (2018). Speaking with a Purpose. New York: Routledge.
- Rajathurai Nishanthi. (2018). The Importance of Learning English in Today World. International Journal of Trend in Scientific Research and Development (IJTSRD). Vol.3, Issue 1.

C.G.G.
**INTEGRATED E-TOOLS FOR COLLABORATIVE WRITING AND FEEDBACK IN TEACHING
ACADEMIC ENGLISH WRITING**

Nur Hafezah Hussein

Universiti Malaysia Kelantan, Kota Bharu, Malaysia
nhafezah@umk.edu.my

Highlights: The integration of technological tools into teaching and learning English writing has received great popularity in the field of higher education. Since the new pedagogical model for technology-enhanced English writing basically encourages online participation and collaboration, this instructional model leads to a new form of social interaction among learners which is the peer feedback. Among various online tools available for learning, Coggle, Google Docs and Google Meet have been incorporated into the teaching and learning of Academic English Writing course. The use of these e-tools not only encourage online collaborative activity and peer-feedback in English writing, but they also enhance active communication and promote learner-empowered learning.

Key words: *e-learning, English writing, Coggle, Google Docs, Google Meet, collaborative*

Introduction

With the shift of educational landscape from traditional classroom to blended learning, and the current pandemic which forces all teaching and learning to be conducted fully online, means that educators need to design interesting activity for their students, especially in teaching Academic English writing.

The online learning and teaching platforms encourage communication, participation and collaboration in language learning and help learners to participate in a more meaningful learning activity. Collaborative learning can be explained as a form of learning activity that is performed in group works for the aims of accomplishing an intended educational objective (Guerrero, Mejías, Collazosi, Pino, & Ochoa, 2003). Collaborative learning boosts higher achievement than individual performance and genuine collaboration accomplishes a given task with collective endeavour (Mindel & Verma, 2006). This also leads to a new form of social interaction between learners in which it encourages peer feedback which is crucial in learning English writing.

Given these scenarios, three popular online tools; Coggle, Google Docs and Google Meet are integrated as an innovation tool to write collaboratively and promote peer feedback in Academic English writing course.

Description of innovation

C.G.G are the initials taken from each of the e-tool used in teaching Academic English writing. C stands for Coggle, G stands for Google Docs and another G stands for Google Meet.

Coggle is an online tool for creating and sharing mind maps. This tool is aimed at helping individuals take notes, brainstorm ideas, visualize connections across concepts, and collaborate with others. Coggle provides a collaborative workspace where users can share ideas, solve problems, and communicate complex information. Uses range from education to business to personal creativity.

Google Docs has shown the potential as an effective online collaborative writing platform for learning English. Google Docs is a web-based free word processor, and the instructor decides to utilize Google Docs as a tool for creating students' writings, peer-editing and submitting. Using Google Doc, students can create online documents and edit them online while they are collaborating with other students or the instructor in real-time.

Google Meet is a website and an app for iOS and Android meant to be a lightweight video chat service. It offers a quick, easy way to connect with other people via live video. It can also be used to do instruction, to hold group discussions, and just to help students connect with each other.

The background of the innovation

Students often complain that they are facing problem with writing in English. The students' difficulties in writing commonly raises in developing and organizing ideas, difficulty with writing tasks and sometimes students don't know how to write in the right order and students are getting bored with the writing process. The problems also come from the lecture or teacher in using the uninteresting technique or the conventional technique to teaching writing (Ingram and Hathorn, 2009).

Thus, using ADDIE model, the instructor has decided to utilise three online tools as the new tools and alternative for collaborative writing and feedback. Lesson plans and activities were developed and designed in a way that these e-tools can be utilised. These e-tools were implemented in Academic Reading and Writing course at Universiti Malaysia Kelantan. This course is a compulsory subject at the university. In this course, group writing assignment is designed as one of the assessments for the students. For the Group Writing Assignment, students will have to work in a team of 3 or 4, and they must write collaboratively, a first draft short research paper, and final draft short research paper.

Importance to education

For students: Using these e-tools, students are given the autonomy in their learning. They will collaborate with their peers to search information related to task given, discuss and revise their work on their own with little intervention from the language instructors. In addition, the students can access their works anywhere, anytime and have complete control of their learning.

For teachers/instructors: Teachers or instructors will be able to use these e-tools in other classes or subjects. They will be also able to assess students' understanding in their learning without spoon-feeding the students. Teachers or instructors play an active role as facilitators to facilitate students' learning. Not only that, the integration of various e-tools in learning is the effort to a more sophisticated e-learning setting which offers meaningful and authentic learning activities.

Commercial Value

Since it is an educational learning innovation, it can be commercialized to all educational institutions locally and internationally. It can be replicated into other subjects, not limited to language courses. Students also have the flexibility to learn at their own pace, self-correct and interact with their peers.

References

- Guerrero, L., Mejias, B., Collazosi, C. A., Pino, J. A., & Ochoa, S. F. (2003). Collaborative learning in creative writing. *Proceedings of the First Latin American Web Congress (LA-WEB 2003)*, 180-186.
- Ingram, A. L., & Hathorn, L. G. (2004). Methods for analyzing collaboration in online communications. In T.S. Roberts (Ed.), *Online collaborative learning: Theory and practice* (pp. 215-241). Hershey, PA: Information Science Publishing
- Mindel, J. L., & Verma, S. (2006). Wikis for teaching and learning. *Communications of AIS*, 18(1), 2-38.

STEM FORENSIC KIT: SCIENCE FORENSIC LEARNING AID

Hazeeq Hazwan Azman

Universiti Selangor, Bestari Jaya, Malaysia
hazeeq87@unisel.edu.my

Muhamad Faqih Damarulan², Muhammad Aqil Noor Azali¹, Maegala Nallapan Maniyam¹, Norazah Mohammad Nawawi¹, Nadzirah Abu Samah¹, Khairil Bariyyah Hassan¹, Hasnur Hidayah Kamaruddin¹, Rahayu Md Khalid¹, Norhisyam Mat Sout¹, Hasdianty Abdullah², Marini Ibrahim², Nur Akmal Suliman², Muzairihana Md Moi², Yusmi Mohd Yunus⁴, Latifah Abdul Latif² & Nor Suhaila Yaacob¹

¹Universiti Selangor, Bestari Jaya, Malaysia

²Universiti Selangor, Shah Alam, Malaysia

muhamadfaqihdamarulan@gmail.com, theyluvaqil07@gmail.com, maegala@unisel.edu.my,
norazah@unisel.edu.my, normawati@unisel.edu.my,
khbariyyah@unisel.edu.my, hidayah@unisel.edu.my, rahayu17484@unisel.edu.my, syamms@unisel.edu.my,
dianty@unisel.edu.my, marini@unisel.edu.my, nurakmal@unisel.edu.my, hana84@unisel.edu.my,
yusmiyunus@unisel.edu.my, latifah@unisel.edu.my, shuhaila@unisel.edu.my

Highlights: STEM education emphasizes the integrated study of science passing the boundaries of traditionally labelled disciplines while demonstrating its application in real life. Science forensics is an enticing STEM field for students since it applies biology, physics, chemistry, and mathematics. STEM forensic kit was developed by lecturers and pre-university students and is based on a detective role-play setup complete with investigation instruments for three activities: fingerprinting, blood typing, and toxicology. The main objective of this forensic kit is to spark students' interest in science and technology through enjoyable detective role-playing games. The exercises included in this product are intended to assist the user in creating a crime scene using the tools and documentation provided. Additional materials such as readily available household items are used to inspire further research for a fun experiment at home. The product's prototype was tested on pre-university students and demonstrated positive results in terms of promoting STEM activities and enhancing STEM skills.

Key words: forensic kit; STEM skills; role-playing, STEM education

Introduction

Developed by UNISEL's academician and pre-university students, the STEM forensic kit is a learning aid comprised of various tools and apparatus that are used in a detective role-play scenario to solve a murder case. Recent study suggested forensic science STEM activities are a good platform to promote multidisciplinary study (Nuttavut et al., 2020). Purposely to spark students' interest in STEM, the exercises promptly offered an exciting problem-solving scenario using household items and supportive documentation to stimulate further research in an enjoyable experiment at home. Stemmed from what started as the core activities in the STEM Query modules, the manual and choice of materials were perfected after hours of on-field application and constructive feedback and are ready to be utilised by educators and parents. The module has been initially used in the STEM Mentor Mentee programme, an effort to impose STEM education by using the near-peer mentoring approach. This MOSTI funded programme has massively contributed to the production of this kit. This learning aid allows the nurturing and development of STEM skills which are vital skills required by graduates to be employable. STEM skills promote and integrate the use of 21st century skills such as creativity, critical thinking and teamwork which enhance the learning experience and equip the students with the ability to solve higher order thinking problems. It also demonstrates the real-life application of science which can make learning more meaningful.

Methodology

STEM Forensic kit is based on a detective role-play setup equipped with investigation tools for 3 activities, Fingerprinting, Blood Typing and Toxicology in solving the mystery behind a murder case. The items in this kit include cue cards, crime tape, magnifying glass, dropper, UV-light pen, small petri dishes, plastic cups and also six vials containing substances to make fake blood and pH indicator.

During the prototype development, the module of this kit was tested in a pilot study involving 36 secondary school students of SBPI Gombak. A 5-points Likert Scale post survey was conducted upon the completion of the module by participants, with 1 as strongly disagree and 5 strongly agree, which was later analysed by using the Statistical Package for the Social Science (SPSS).

Table 1: Participants' feedback after completing the science forensic module.

Category	Average Mean	
	The module is interesting	If qualified, I would like to pursue my study in STEM field
Gender	Male	5
	Female	4
Course	Pure Science	3
	Islamic Science	5

Table 1 shows the average mean of participants' feedback on post survey. Overall, a very promising result can be observed with all students from both pure science and Islamic science courses find the module interesting with males showing greater interest. Although all students gave a positive feedback on their tendency to pursue STEM field education, it is interesting to highlight that Islamic science background displayed higher agreement towards this statement.

Conclusion

STEM Forensic Kit: Science Forensic Learning Aid is an excellent teaching and learning kit because it covers all elements of STEM education. For educators and parents looking for application-based STEM activity, STEM forensic kits can be a great option. Besides, this kit is able to provide early exposure to STEM education in order to cultivate the interest of the younger generation in STEM. Pre-university students were among the audience whom the prototype was shared with and it gave promising results in promoting STEM activities while stimulating the STEM skills. It also provides exposure to an interesting STEM career, namely forensic experts and science analysts. Keeping students, teachers and parents in mind, the forensic kit can be made available in the market at a comparatively low price. This is to ensure that it will stay affordable and competitive, highlighting its promising commercialization potential.

Acknowledgement

We gratefully thank National STEM Association (NSA), UM STEM Centre and SBPI Gombak for their significant involvement towards the kit development. We would also like to express our highest gratitude to MOSTI for the funding in STEM Mentor Mentee project, which contributed to the development of this kit

References

Nuttavut, N., Triampo, D., Amornsamankul, S., & Triampo, W. (2020). STEM-based Learning Blended with Inquiry-based Learning for Medical Students through Forensic STEM Activities. *Education*, 8, 12.

COMPRESSOR DUSTBIN

Siti Noor binti Abdullah

Politeknik Kota Bharu, Kelantan, Malaysia
sifinoor@pkb.edu.my

Rohani binti Yusof, Nur Amirah binti Mat Zubir

Politeknik Kota Bharu, Kelantan, Malaysia
rohani@pkb.edu.my, amirahzubir@pkb.edu.my

Highlights: Compressor dustbin is an improvement of an ordinary dustbin. This innovation designed to overcome the waste problem during Movement Control Order (MCO) due to Pandemic COVID-19 in Politeknik Kota Bharu, particularly in the hostel residence. Compressor dustbin is an initiative to keep environment hostel known as Kamsis clean and it is also eco-friendly. This dustbin is easy to handle and battle trash can odours.

Key words: *Compressor dustbin, waste problem, odors*

Introduction

Currently, there has been an increase in waste in Kamsis Politeknik Kota Bharu during the Movement Control Order (MCO) because of the Solid Waste Management only take the waste depend on schedule not every day. So that, there is an abundance of garbage from the bins and cause pollution and dirty around the bins. Therefore, the use of Compressor Dustbin will be able to overcome the problem and ease the duties of cleaning workers and to keep clean and cheerful scenery in the hostel area and will indirectly give a good image of Politeknik Kota Bharu in the community.

Product Development

The main material used in the development of Compressor Dustbin are dustbin, polyvinyl chloride (PVC), rivet nuts, plywood, handsaw, bow saw, screw and PVC pipes cutter. There are a few steps to make this dustbin.

Step 1: Cuts PVC pipes and plywood to the size needed.

Step 2: Stacks 2 units PVC pipes with T junction pipe.

Step 3: Cut the dustbin cover to make a hole, then insert the PVC pipes which after that will be screwed with plywood cut as a compressor.

Once the waste enters the dustbin, people can compress waste using handle on dustbin to prevent the waste out from dustbin. Figure 1 below shows the materials needed to produce the Compressor Dustbin and Figure 2 the image of Compressor Dustbin.



Figure 1: Materials to produce Compressor Dustbin



Figure 2: Compressor Dustbin

Significance of Product

Compressor Dustbin is environmentally friendly, as it uses materials that are free from hazardous substances which do not harm to human. This dustbin is simple and easy to handle, especially by students that stay in Kamsis Politeknik Kota Bharu. It also very systematic, save time to manage waste in daily life and affordable to have.

Feasibility Study of Product

A total of 80 students that stay in Kamsis and 5 cleaning workers that handle waste in Kamsis was participated in this survey to find out the needs of the Compressor Dustbin and to measure how students in Kamsis manage waste during Movement Control Order (MCO). Based on observation within 2 weeks that has been improvement on waste management in Kamsis when use this Compressor Dustbin.

Marketability of Product

The cost of producing Compressor Dustbin is quite affordable. However, the production may be worth it if the Compressor Dustbin produced in a bigger quantity. This Compressor Dustbin has commercial potential due to the waste management are common problem especially in campus residences in Malaysia. The usage of Compressor Dustbin is also safe to the environment as it uses materials that are 100% free from hazardous substances. Compressor Dustbin also easy to handle and suit to put it in any places as deemed necessary. In the future, the researchers hope to promote Compressor Dustbin using social media such as Instagram, TikTok and Facebook. The product features will be improved in terms of size to match the needs of prospects customers.

Acknowledgement

We are grateful to all respondent and management of Politeknik Kota Bharu for their support which enable us to complete this project successfully.

References

KyRe@tif. (2014, March 21). <https://www.blogger.com/profile/02115055483447964788>.

Retrieved from http://sukses5s.blogspot.com/2014/03/5s-apa-itu-eksa_21.html?m=1;<https://www.blogger.com/>

Wikipedia. (n.d.). https://en.m.wikipedia.org/wiki/Environmental_protection.

Interview with students and cleaners in Kamsis Politeknik Kota Bharu

SURPRISE BOARD TO ENHANCE COMMUNICATION SKILLS

Che' Fadhilah Binti Che' Lah

Politeknik Kota Bharu, Ketereh, Malaysia
chefadhilah@pkb.edu.my

Shuzura Binti Yusof, Melissa Khor Suan Chin

Politeknik Kota Bharu, Ketereh, Malaysia
shuzura@pkb.edu.my, melissa@pkb.edu.my

Highlights: This innovation is called Surprise Dart (SD). This is because it brings the element of surprise to the players. This game is an innovation game that requires psychomotor skills for the players to aim and throw the dart at the target. If the player missed the board, the player will go through the English educational and knowledge penalty. Whereas, cognitive skills will require the players to understand the task given and respond accordingly, while affective skills include communication and team work. This innovation can give the students pleasure to play the game indirectly whereby the usage of English can be applied. This game can be played by individual or teams. Throughout the game, all the players need to converse and interact using English. The players can enhance their basic English, improve their vocabulary and develop their oral presentation skills. This surprise dart is a good learning experience for those who play this game. The mechanics of the game consist of throwing darts at a target that is divided by segments, and each of them is assigned a task. To know what the task is, they will need to refer to the surprise board. On this board, there are different presentation task. Every player can only perform their specific task based on the target hit earlier.

Key words: *English language, Psychomotor Domain, Affective Domain, Cognitive Domain*

Introduction

In Polytechnics, students need to do a few English presentation for English subjects or other subjects. Most of the students having a phobia to speak English during their presentation. This not only for English subjects but also in other core subjects as well. Due to this phenomena, Surprise Dart is create to give the excitement while throwing the arrow accurately to the center of the Dart board and pleasure to speak English while pointing the arrow to the center of the board. Once the arrow reached any segments on the dart, the students will get the easiest topic if they are able to point on the bullseyes, and the difficult topics will be at others segments on the Dart Board.

Due to the student's reluctant to speak English in front of others, the students will give reasons that they are not ready for the presentation and time allocated. Then, it affects the times spent by teachers, or educators on the presentation itself and waiting for hours just to hear the presentations of projects, industrial report and gists of their understanding on subchapters of their core subjects as well. The topics will be match and given based on the arrow landed on numbers of segment on the Dartboard given. Hopefully, students will have fun while playing SD soon. The end of the game is the excitement of knowing the mystery gift that students will receive. By this trigger, the students will try harder to throw the arrow to the best segment that they are willing to reach it. It not only about the special gift that they willing to have it but the willingness to have the best spot in their games showing the main part of playing SD with simple language practices.

Practice makes perfect! The polytechnic students must focus on learning the necessary vocabulary and learning on how to use the language with full sentences. That will help the players to deliver their language with the basic meaning from the games. This is the best way to the players to learn a language.

Content

1. Description of the innovation

SD will be separate into two team either individual or grouping. This game is to create wonderful environment while speaking English through playing game. For the beginning, SD could be play by individual which really suitable for impromptu speech wrap-up class to identify and recognize which students are understand the selected subtopics once lecturer finish the chapter. This game is suitable for Presentation, core Subjects such as Principle Marketing and others subject in polytechnic.

Otherwise, SD also could be play by group members. A representatives of the group will throw the arrow, the highest point obtained will be the last group to start in the second round and other rounds as well. Second round, will begin with the least score from rules number 1. Once the arrow is park at any number on the board of darts, the person needs to find what is the topic of questions of that particular number. Meanwhile, in the third round, group needs to discuss (in English) and opt a second person to throw the arrow of his best, so that the point accumulated better than other groups.

2. The context or background of the innovation

The project of SD follow these steps; Firstly, it is concern on rules and regulation on how to play this game. Of course, all members need to speak English while do a discussion among the members. Anyone who speaks Bahasa Malaysia are responsible for the point deduction, and it affects the score of their group. Next, the questions are the easiest for Bull eyes and it will be very difficult at other segments. The mystery gift will be given if you score many Bull eyes from the specific duration. Last steps is on how to count mark during this wonderful game. The important rules are as followed. The players must aim for double ring 2x the number stated on the board. They need to play until get through triple ring 3x the number stated on the board. The players also will be given marks according to their achievement such as for a single bull will get 25 points and the players who can get the Bull eye will be getting 50 points easily. That is how we can play this game.

3. The important of SD to education in Malaysia

This SD project is giving big impact to all educators especially when they are facing some challenges that the English language learners in Politeknik Kota Bharu face such as many of the students are low motivation to learn and speak confidently in English. The reasons that mostly student gave they are able to understand others speak but having difficulty to respond back in English because of the insufficient English vocabulary. So, many educators believed that if the polytechnic students want to be good they can master English language by speaking or presenting it to other students.

4. The advantages of the innovation towards education and community.

The advantages of this surprise Dart (SD) are able to cover 3 domain of learning such as for Holistic learning: This innovation aims to create a holistic learning experience by incorporating all the three domains in learning: cognitive, psychomotor and affective. Psychomotor Skills: It is an innovation game that requires psychomotor skills for the players to aim for the target and throw the dart at the target. Cognitive skills: Cognitive skills will require the players to understand English learning through reading the requirement of the task and responding to it by communicating their ideas and opinions. Affective skills: The affective skills involve feelings, attitudes and emotions while players interact with their peers during the game.

5. The commercial value in terms of marketability or profitability of the innovation.

The project SD is suitable for Commercialisation. Surprise Dart enable many users to full fill the needs to enjoy the games and at the same time are able to become a tool to do the impromptu presentation and as follow-up gadget to recognized the levels of understanding in the core subjects while they are enjoying to shoot the best target on the Dart Board. The idea of having SD in a class is very attractive to the students because the excitement can be seen. The students enable to complete any tasks required because it can easily be used everywhere inside the class or outside the class, affordable and able to capture student's interest. In addition, it can be adapted to the various subjects and levels of education from primary, secondary and tertiary levels.

References

- Alaayah, J. & Bawani, S (2016). Developing Reading Skills. Oxford Fajar Bakti Sdn.Bhd
- Kathryn, SY. & Howard, P.T. (2018). Oral communication: Skills, Choices & Consequences (4th Ed.). Waveland press
- Koch, A., Schmitt, J. (2018). Speaking with a Purpose. New York: Routledge.
- Rajathurai Nishanthi. (2018). The Importance of Learning English in Today World. International Journal of Trend in Scientific Research and Development (IJTSRD). Vol.3, Issue 1.

DEVELOPMENT OF FLIP CLASSROOM INTERACTIVE NOTES FOR BUILT UP RATES

Ross Saliha Safura Binti Hamzah
Polytechnic of Kota Bharu, Kota Bharu, Kelantan
salihasafura@pkb.edu.my

Affidah Mardziah binti Mukhtar, Dr. Tengku Ahmad Badrul Shah Bin Raja Hussin
Polytechnic of Kota Bharu, Kota Bharu, Kelantan
affidah.mukhtar@gmail.com, tabadrulshah@pkb.edu.my

Highlights: Interactive Notes for Built Up Rates is a learning and teaching innovation material for the Estimating 2 course of Quantity Surveying Programme, Polytechnic of Kota Bharu. Result from the entrance survey found the students still failed to understand the built-up rate topic. The factors indirectly affect the students to be motivated and excellent in the course. Therefore, the author has taken the initiative to develop the notes to help a total of 70 students from 3 different classes. From the exit survey, it was found that these interactive notes have developed counting skills and improved problem -solving abilities among the students.

Keywords: *Innovation, Interactive Notes, Built up rates, Quantity Surveying Programme*

Introduction

Development of flip classroom interactive notes for built up rates has been designed to address students poor understanding on the calculation concept of built up rates. The objectives of the study are to measure level of understanding of the students on the calculation concept of built up rates. Then to develop flip classroom interactive notes to helps students easily understand the calculation concept of built up rates and applied unit conversion effectively.

The study was conducted on semester fourth students of Diploma Quantity Surveying Program, Polytechnic Kota Bharu involved 70 students from 3 different classes.



Figure 1: Respondent for Development of Flip Classroom Interactive Notes for Built Up Rates study

Through the study of Zainol Mustafa, Wong Wai Ling and Mohd Rashid Ab Hamid (2013), Students' Perceptions of Engineering Learning Outcomes have shown that the results of the two analyzes made have been able to identify and confirm two important elements in engineering learning outcomes are from in terms of (i) perceptions in technical field knowledge and (ii) perceptions in general field knowledge.

Product Development, Design and Process

Development of Flip Classroom Interactive Notes for Built Up Rates study is referred to Figure 2: Flow of methodology as below. Once the problem statement of the study is identified then the objectives of the study are formed. After that the research methodology is determined to ensure that the objectives can be achieved.



Figure 2: Flow of methodology

To ensure that these innovation needs are met. A study, through the Course Exit Survey for the course DCQ5192 Session June 2019 (PKB Exam Database, 2019) was conducted. The results showed that the level of understanding of students for the topic of built up rate as in the analysis table below.

Table 1 : Exit survey comparison data for the June 2019 session and the December 2019 session

TOPIC	EXIT SURVEY ANALYSIS DATA SESSION JUN 2019		ANALYSIS DATA SESSION DISEMBER 2019	
	Uncertain, Do Not Understand And Very Understand	Understand And Very Understand	Uncertain, Do Not Understand And Very Understand	Understand And Very Understand
Built Up Rates	23 = 24%	73	127 = 22.4%	439
Cost Estimating	0 = 0%	96	10 = 1.8%	556
Estimating Work	0 = 0%	96	7 = 1.2%	559

For this innovation, Pear decks are used as an additional item in Google Slides (Mache et al., 2017) and (Twyman & Heward, 2018). These additional features need to be added manually. The pear deck allows teachers to easily add interactive elements to the teacher presentation slides. The development of the innovation "Flip Classroom Interactive Notes for Built Up Rates" has been planned to overcome the student's problems in understanding on the concept of build rate calculation. The resulting innovation is in a form of multimedia innovation that uses Pear Deck in conjunction with Google Slide. The display of the innovation diagram above is mapped to show the content and basic breakdown of this innovation product. Refer to Figure 3: Basic breakdown of innovation product.

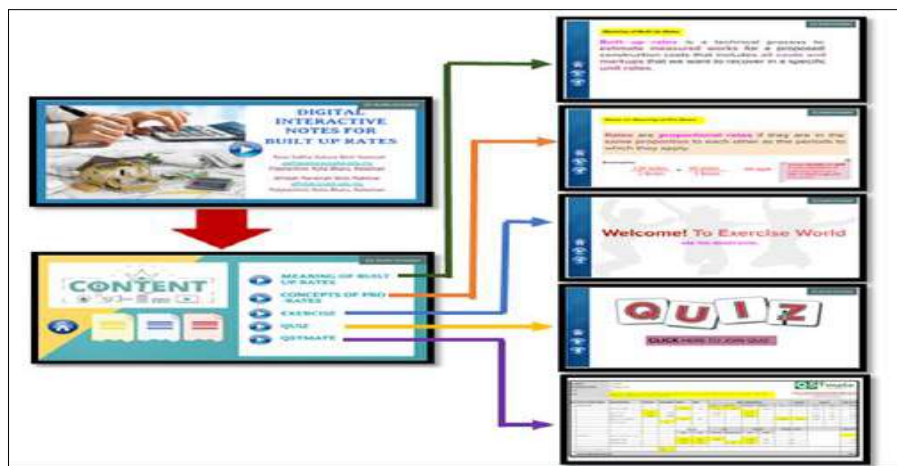

Figure 3: Basic breakdown of innovation product

Here are the features of the Interactive Notes Built Up Rate innovation:

1. Feedback Function
2. Identification Function
3. Interactive Functions
4. Self Notes and Reinforcement Functions
5. Training Functions to Test Comprehension
6. Answer Functions and Calculation Steps
7. Functions to Test Comprehension
8. Colour Variety Function
9. Audio Function
10. Functions Diversity of activities
11. Functions of mobile applications

Result

Achievement for the objectives of study is measured through the following methodology;

1. Questionnaires were given to analyse the level of understanding of the students and the data has been analysed using excel to get the percentage of the result
2. The flip classroom interactive notes for roofing work has been developed by using google slides to validate the effectiveness of teaching and learning concept in transferring knowledge to the students.
3. The QSTmate been developed using excel for students to apply conversion unit effectively.

The impact can be seen through comparative data before and after the use of the Interactive Notes for Built-up Rates as figure 4: Level of understanding before and after use the innovation product.

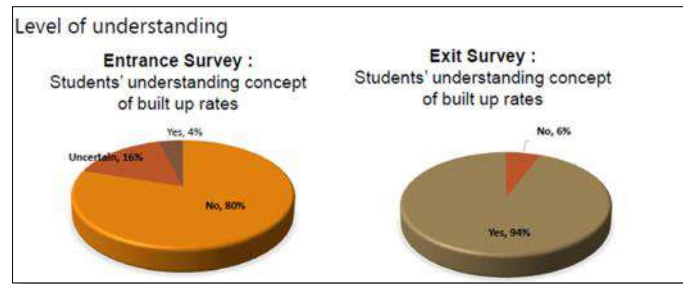

Figure 4: Level of understanding before and after use the innovation product

Discussion

Overall, the study was found that the impact of the Interactive Notes for Built Up Rates application is as follows:

1. Cost - Students do not need the cost to use the pear deck application to help improve the effectiveness of their Teaching & Learning
2. Time - The time of use of this application is flexible in terms of time and according to the suitability of the students themselves.
3. Technology - The technology used is in line with the development of smartphones and takes into account the disadvantages of poor internet access
4. Others - Motivate students to interact in class, increase the creativity of the lecturer's R&D induction set, foster the concern of students-lecturers, build students' focus on R&D and create joy and enjoyment of learning in the classroom.

Acknowledgement

We would like to thank Polytechnic of Kota Bharu, Kelantan for their assistance and technical management as well as space and assets belonging to the institution during the process of conducting this study.

References

- Mache, J., Tan, N., Shoemaker, G., & Weiss, R. (2017). Pear Deck: an interactive classroom response system to encourage student engagement. *J. Comput. Sci. Coll.* 33(1), 156-158. Retrieved from <https://dl.acm.org/citation.cfm?id=3144636>
- PKB Exam Database, (2019)
- Twyman, J.S., & Heward, W.L. (2018) How to improve student learning in every classroom now. *Int. J. Educ. Res.* 87, 78-90. <https://doi.org/10.1016/j.ijer.2016.05.007>
- Zainol Mustafa, Wong Wai Ling and Mohd Rashid Ab Hamid (2013). *Persepsi Pelajar Terhadap Hasil Pembelajaran Bidang Kejuruteraan*. Jurnal Teknologi. Penerbit UTM Press

CREATE YOUR SOCIAL ENTREPRENEURSHIP (CYSE)

Sathiswaran Uthamaputhran

University Malaysia Kelantan, Kota Bahru , Malaysia
sathiswaran@umk.edu.my

Hasannuddiin Hassan, Mohd Ikhwan Aziz

University Malaysia Kelantan, Kota Bahru , Malaysia
hasann@umk.edu.my, ikhwan.a@umk.edu.my

Highlights: Create My Social Entrepreneurship (CMSE) is an entrepreneurship process that emphasis on problem solving learning that support the development of social entrepreneur. This model helps the individual to create an effective idea combine together with social impact and turn them into an opportunity.

Key words: Social Entrepreneurship, problem-solving, experiential, learning

Introduction

The conduct of education in this 21st century has been witnessed with a paradigm shift from face-to-face teaching environment to a more technology-based learning environment. The advancement of ICT has influenced the development of education. This has led to a more practical or experiential based learning were implemented especially in the subject area of entrepreneurship. With this new learning students are exposed with student-centred learning where it all begin with problem solving method in entrepreneurship. Meanwhile, on the other hand, various educators and practitioners have criticized conventional way of teaching which they feel outdated and need to revamp. Most of the students doesn't continue their entrepreneurship activities upon their graduation which worry most of the entrepreneurial university. Therefore, we have introduced our new student-centred mode called Creating Your Social Entrepreneurship (CYSE)I which help them to transform the idea or opportunity in business and continue their career as an entrepreneur.

Content

Description of your innovation / product development / design / process.

Create My Social Entrepreneurship (CMSE) is an entrepreneurship process that emphasis on problem solving learning that support the development of social entrepreneur. This model helps the individual to create an effective idea combine together with social impact and turn them into an opportunity. Innovative idea can be generate systematically, based on keen observation and reasoning, as well as creativity. At the same time, converting a promising idea into a workable and attractive opportunity requires an on-going creative process working hand-in with focused analysis, experimentation and sometimes even launching the initial stages of a new venture. It is designed to develop student's entrepreneurial knowledge, skills and abilities to effectively use creativity and innovation as a benchmark to make a better sense of problems. It begin with a "wicked problem". This social entrepreneurial process has 9 stages which we believe can change the student mindset and behavior and start to engage with having a new social venture. This model can be used in many entrepreneurship courses to make the entrepreneurship subjects more fun, easy and effective to learn.

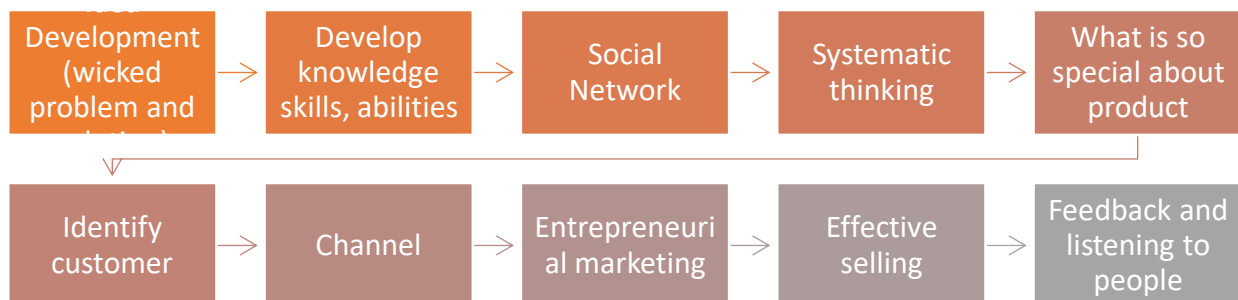

Why are they important to education?

1. CYSE is a problem-solving method used experiential based learning and does not use conventional learning
2. The idea look more solid and doable with this new model
3. It change the student mindset to be more realistic about new ideas and more importantly the classroom will not get bored with normal lecture and slides.

Commercial value in terms of marketability or profitability of your innovation / product development / design / process

1. Novice entrepreneurs who want to start a business can seek for this model because it helps them to improve the business idea and follow the whole entrepreneurship process. It can be used by new entrepreneurs who want to become an entrepreneur
2. Universities can use this model to teach students on how to become an entrepreneur during their university time.
3. Can be a guideline for the government agencies to teach individuals to become an entrepreneur. Since entrepreneurship process starts with identifying the problem, this model can serve them with more solid idea on how to tackle the problem.

References

- Adhalina, N. (2011). The Different Language Style and Language Function Between Students and Teachers in Updating Their Status In Facebook Webpage (A Case Study of the Topic National Final Examination 2011)(Doctoral dissertation, University of Diponegoro).
- Alessandra, A. J., O'Connor, M. J., & Van Dyke, J. (1994). People Smarts: Bending the Golden Rule to Give Others what They Want. Pfeiffer.

WRITER BOOSTER

Mohd Zulkifli Muhammad

Faculty of Entrepreneurship and Business, Universiti Malaysia Kelantan
City Campus, 16100 Kota Bharu, Kelantan
zulkifli.m@umk.edu.my

Ahmad Ridhuwan Abdullah, Zul Karami Che Musa, Azwan Abdullah, Noorshella Che Nawi, Mahathir Muhamad

Faculty of Entrepreneurship and Business, Universiti Malaysia Kelantan
City Campus, 16100 Kota Bharu, Kelantan
ridhuwan.a@umk.edu.my, zul@umk.edu.my, azwan.a@umk.edu.my, norshella@umk.edu.my,
mahathir.m@umk.edu.my

Highlights: Writer Booster is an academic writing that combines the cloud-based collaborative writing environment concept and the important principle of time management for academic writing purposes. The platform enables the users such as academicians, young researchers, undergraduate and graduate students to improve their academic writing from the online coaching, feedback, monitoring, and evaluation system. The ability of the platform to store information on the users' writing activity and output also provide the administrators (e.g., the management of a faculty or university and supervisors) to have an informative report that is useful for performance management and culture of excellence in academic writing.

Key words: *Academic writing; time management; cloud computing; collaborative; crowdsourcing.*

Introduction

Writer Booster is an academic writing that applies the cloud-based collaborative writing environment concept and the important principle of time management to elevate academic writing and foster the culture of excellence among the intended users. These objectives are vital in meeting the current demand in the academia world and the transformation of future learning process due to the rapid development in information technology, particularly in niche area of teaching and learning.

For example, writing for publication becomes more challenging as academic writers need to consistently update their knowledge and skills due to the increasingly complex but interesting projects in their fields (Casanave, 2019). Given the progressively significant role of information and communication technologies as the driver of global educational reform (Saltman & Means, 2018) and the challenges in academic writing, there is a need to invent a system that can help and boost academic writers in their writing activity.

Originality of The Innovation

Copyright no. CRLY00014254 (10 July 2019)



Perbadanan Harta Intelek Malaysia
Intellectual Property Corporation of Malaysia
(Berbadan)

Unit 3.7 & 3.8, Menara UDA, Bangsar, No. 5, Jalan Bangsar Utama 1
05100 Kuala Lumpur
Tel : +603-23984602 Faks : +603-2398 8989
Laman Rangkaian : www.mypipo.gov.my

MOHD ZULKIFLI BIN MUHAMMAD
UNIVERSITI MALAYSIA KELANTAN (UMK)
FAKULTI KEUSAHAWANAN DAN PERNIAGAAN, UNIVERSITI
MALAYSIA KELANTAN
BEG BERKUNCI 36, PENKALAN CHEPA,
16100 KOTA BHARU
KELANTAN

NOTIS PEMBERITAHUAN HAK CIPTA
(Seksyen 208, Akta Hak Cipta 1987)

Tuan/Puan
Sukacita dimaklumkan, maklumat butiran Pemberitahuan Sokarata Hak Cipta tuan/puan telah direkodkan ke dalam Daftar Hak Cipta sebagaimana diperuntukkan di bawah Seksyen 208, Akta Hak Cipta 1987. Butiran Pemberitahuan Hak Cipta tersebut dirujukkan seperti berikut:

TARIKH PERMOHONAN	08/07/2019
NO. PERMOHONAN	LY2019003444
NO. PEMBERITAHUAN	CRLY00014254
TAJUK KARYA	I-Falah Writing Platform
KATEGORI KARYA	SASTERA
TARIKH PENERBITAN PERTAMA	04/05/2019

PENCIPTA
MOHD ZULKIFLI BIN MUHAMMAD
AHMAD RIDHUWAN BIN ABDULLAH
ZUL KARAMI BIN CHE MUSA
AZWAN BIN ABDULLAH
ABU AZIZ BIN MAT HASSAN
MUHAMMAD NAQIB BIN MAT YUNOH
MAHATHIR BIN MUHAMAD
SITI SALWANI BINTI ABDULLAH



MOHD ZULKIFLI BIN MUHAMMAD
AHMAD RIDHUWAN BIN ABDULLAH
ZUL KARAMI BIN CHE MUSA
AZWAN BIN ABDULLAH
ABD AZIZ BIN MAT HASSAN
MUHAMMAD NAQIB BIN MAT YUNOH
MAHATHIR BIN MUHAMAD
SITI SALWANI BINTI ABDULLAH

PENYANYA
: TIDAK BERKAITAN

PENEGANG LESEN
: TIDAK BERKAITAN

Tuan/Puan boleh memohon Sijil Pemberitahuan Hak Cipta dengan mengemukakan Borang CR-5 seperti dikepitkan bersama. Pihak tuan/puan juga boleh memohon petikan yang diperakui sah daripada Daftar Hak Cipta yang boleh dijadikan satu keterangan *prima facie* mengenai butiran yang direkodkan.

Sukacita dimaklumkan juga, sekiranya terdapat sebarang perubahan maklumat sedia ada, pihak tuan/puan dinasihatkan kemukakan maklumat perubahan tersebut untuk direkodkan dalam Daftar Hak Cipta.

Sekian, terima kasih.

"BERKHIDMAT UNTUK NEGARA"
Says yang menjalankan amanah.

(Signature)

(MAWAR HARTINI MD MAZLAN)
D.p. Pengawal Hak Cipta
Perbadanan Harta Intelek Malaysia
Tarikh: 10/07/2019

Publications/ Awards

This innovation has been documented in a number of publications, including: a) Writer Booster: Teknik Penulisan Akademik Berasaskan Pomodoro, Caknawan, Jilid 5 Bil 1, 2019; b) Implementation of Shariah Compliance Writing Platform Application Algorithm, SGJP MyRA Keserakanan USM, 2019.

Apart from that, innovation has received a number of accolades, including: a) Gold Award in Teaching Enhancement and Learning Innovation Carnival 2019 (TeLIC 2019) on 21st May 2019 at UMK Kampus Bachok; b) Silver Award in International University Carnival on E-Learning 2019 (IUCEL 2019) on 21-22 Ogos 2019 at UNIMAS Sarawak; c) Silver Award in Conference on Islamic Invention and Innovation 2019 (I-CIPTA 2019) on 30 Julai 2019 at UiTM Melaka.

Applicability of The Innovation

i. Usefulness in problem solving

- Helps and strengthens academic writing through an interactive and effective virtual supervision, guidance, control, and monitoring system.
- Improves the quality and quantity of academic writing through.
- Enhances focus when writing academic manuscripts.
- Promote academic collaboration activities through crowdsourcing.

ii. Due diligent

- The system was developed fully by the academician.

iii. Newness design/process incorporated

- Time management, monitoring system, writing assistant (e.g., article journal templates), and crowdsourcing platform.

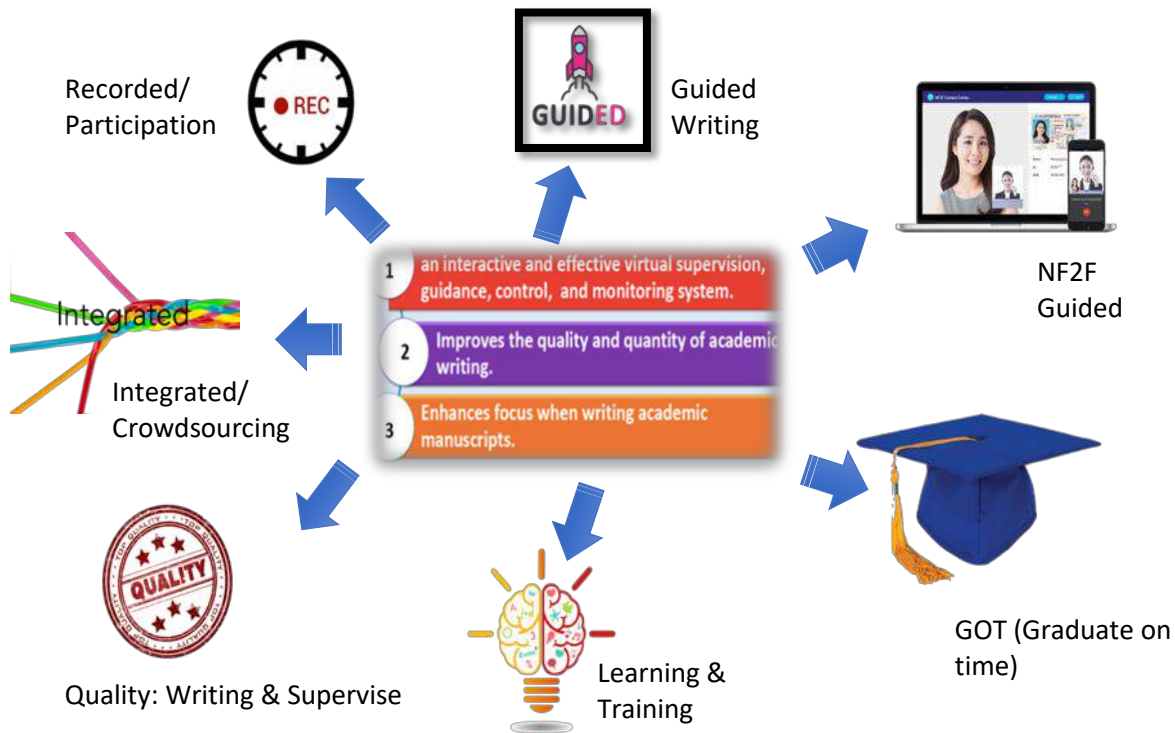

Status of The Innovation

- Technology Readiness Level (TRL): 9/10

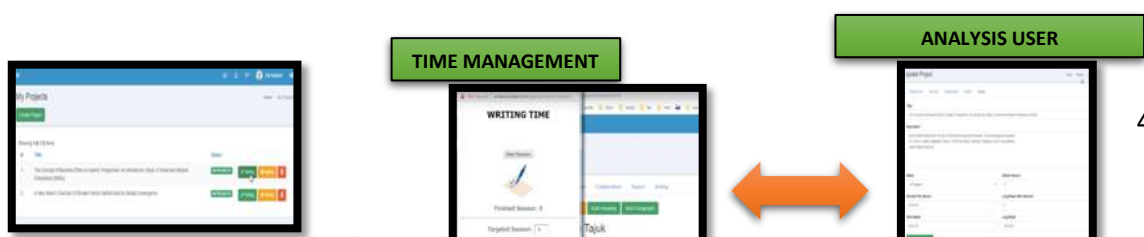

Commercial Potential

i. Market potential/Social

Potentially to be introduced and used by postgraduates or young academics, especially to those who are new to the academic writing. Also, the collaboration platform through crowdsourcing concept enables them to collaborate with academic or language experts: postgraduates publicly offer a job (e.g., language editing, proofread, etc) to the registered members on the platform.

Ready market:

- All Higher Education Institution in Malaysia (especially HIS who target GOT)
- Internal – UMK
- All Polytechnic Institution
- Others University

Potential market:

- Internal and external trainer /company

ii. Potential market size

15 percent of total postgraduates and academics around the world.

iii. Technology transfer potential/Industrial partner

Public universities in Malaysia and overseas, publishers.

References

- Ahmad, S., & Rawian, R. M. (2020). The effects of lexical profiling tools on academic writing performance. *Asian Social Science and Humanities Research Journal*, 2(2), 96-106.
- Crossley, S. A., Russell, D. R., Kyle, K., & Romer, U. (2017). Applying natural language processing tools to a student academic writing corpus: How large are disciplinary differences across science and engineering fields?. *Journal of Writing Analytics*, 1, 48.
- Khiri, M. J. B. A. (2019). Implementation of guided group academic writing using online learning tools. *Trends in Undergraduate Research*, 2(2), 1-8.
- Scholnik, M. (2018). Digital tools in academic writing?. *Journal of Academic Writing*, 8(1), 121-130.
- Strobl, C., Ailhaud, E., Benetos, K., Devitt, A., Kruse, O., Proske, A., & Rapp, C. (2019). Digital support for academic writing: A review of technologies and pedagogies. *Computers & Education*, 131, 33-48.

MUSLIMAH SAFETY BAG DEVICE

Rohana binti Abdullah

Politeknik Kota Bharu, Malaysia
rohanaabd@pkb.edu.my

Zunaidawati binti Mat Daud, Azizah binti Che Musa

zunaida39@gmail.com, azizah@pkb.edu.my

Highlights: This muslimah safety bag device as an example for students to create an innovation that can give students the opportunity to develop their talents in Islamic innovation. This innovation is also one of the innovations associated with the MPU 23052-Science and Technology in Engineering course where students are required to think creatively in order to create an innovation in accordance with the vision of Leader in Industry-LED TVET Institution by 2025 and the mission of Empowering TVET in producing holistic graduates.

Key words: *prayer, kusyuk, religion, property, safety, device and life*

Introduction

The rising crime rate and involving the lives of Muslim mosque worshipers when performing prayers in the mosque causes their focus to be distracted when thinking about the safety of personal belongings. Concerns about safety while at the place of worship also sometimes make the prayers not solemn and there may also be those who want to fulfill the demands of the religion as soon as possible. Cases of loss of belongings while performing duties in a mosque or surau are not something new. In fact, criminals are also increasingly daring to take advantage even though they know they are committing sins in the holy area. Criminal cases currently know no place. Indeed, the atmosphere of placing a handbag in front of the head while praying is very synonymous while at the surau or mosque to prevent theft. However, the house of worship is no longer a guarantee that crime does not occur in it. be able to solve problems that occur in Malaysian society.

Content

1. Description of the innovation

The security device for Muslimah is an innovation that results from a combination of two main devices, namely the mini alarm and the safety chain. This device will be mounted on the bag and limbs ie legs during prayers. The control device will sound if the safety chain is pulled or pulled by someone. Based on current issues and news displayed in electronic and print media many cases of theft that often occur in the mosque, especially to Muslim women who are praying in the mosque. This innovation is particularly important as an example of the applications taught in the MPU23012-Islamic Studies module and the MPU 23052-Science and Technology in Engineering module

2. The context or background of the innovation

Based on current issues and news displayed in the electronic and print media, there are many cases of theft that often occur in mosques, especially to Muslim women who are praying in mosques. This problem of crime often haunts the women pilgrims causing them a phobia to pray in the mosque as it not only involves property but their lives due to the greed of snatchers who do not know the meaning of mercy.

3. The importance of this innovation to education

This innovation is particularly important as an example of the applications taught in the MPU23012-Islamic Studies module and the MPU 23052-Science and Technology in Engineering module. The device used meets the standards of Islamic Shariah which is to keep the religion that is devout in prayer because there is no need to think about the safety of stolen bags and so on, property that is to keep the bag and life safe that is the alarm will sound when the bag is pulled or pulled by someone.

4. Advantages of the innovation towards education and community

This device provides an advantage in terms of helping users maintain the safety of the bag as well as can help save someone's life when the device sounds. With this safety device, prayers can be performed with devotion as required in Islam " devout in his prayers. " [Surah al-Mu'minun 23: 1-2].

5. Commercial value in terms of marketability or profitability of the innovation

In our opinion, this Muslimah bag safety device can be commercialized because the basic materials to produce it are very cheap. Therefore it is an affordable innovation to all women. This tool is very user friendly as every age group can use it safely.

References

- Aida sue(2013).Wanista. video *Ragut ketika Solat Jemaah*.9.00am.[https://wanista.com/2013/21406/video-ragut-
ketika-solat-jemaah-hati-hati-letak-beg-sewaktu-solat-di-suraumasjid/](https://wanista.com/2013/21406/video-ragut-
ketika-solat-jemaah-hati-hati-letak-beg-sewaktu-solat-di-suraumasjid/)
- Affezy Azman (2019) *Curi Beg Tangan warga Emas Ketika Solat Subuh* .10.15am
<https://www.astroawani.com/berita-malaysia/curi-beg-tangan-warga-emas-ketika-solat-subuh-197930>

QS JUNIOR MOBILE LEARNING APPLICATION

Sukmawati Ismail

Department of Civil Engineering, Politeknik Kota Bharu, 16450 Ketereh, Kelantan.
sukmawati@pkb.edu.my

Nor Ashikin binti Mazlan, Zahurin Binti Husin

Department of Civil Engineering, Politeknik Kota Bharu, 16450 Ketereh, Kelantan.
norashikin@pkb.edu.my, zahurin@pkb.edu.my

Highlights: Building Work Measurement (BWM) course is one of core courses and must be proficient in by Quantity Surveying Diploma student in Malaysia Polytechnics. Teaching & Learning (T&L) time for this course is 6 hours a week where 2 hours is allocated for theoretical lectures while another 4 hours for practical and tutorial. Compulsory reference book for this course is Standard Method of Measurement 2 (SMM2). The results of the survey with the Building Works Measurement lecturers found that there are some students failed to bring SMM2 reference book during class. This may result the students having difficulty to follow and understanding the lecture. Thus, will affecting their ability to answer tests, quizzes and completing exercises during class. This also may result the student being less interested and can not become excellent in this course. As a result, researchers have made a study on mobile applications as a teaching tool in the teaching and learning process. The main purposes of this project are to (1) develop the QS Junior mobile application and (2) know the level of acceptance of the mobile application. The QS Junior mobile application was used as teaching aids during the Building Works Measurement and used by students during the lectures. This suggests that 'QS Junior' mobile application was proven to be accepted by students to be one of the teaching tools for the Building Works Measurement courses.

Key words: 'QS Junior' mobile application, teaching tools, Building Works Measurement

Introduction: The Development of Qs Junior Application

The development in Information and Communication Technology (ICT) affecting all aspect includes educational lines. The development in technology also transforms a human way of learning (Naismith et al., 2004). Moreover, teaching and learning process now go beyond the class physical space (Kukulka-Hulme & Traxler, 2005), globalise and lifelong (Sharples, 2000). Technology also becomes a bridge between students and their former knowledge with a new learned knowledge which includes in constructivism theory (Jonassen, 2000; Grabe & Grabe, 2004). Thus, ICT also gives impact to Malaysian educational system especially in teaching and learning side.

Educational system also experience another new evolution in technology when Mobile Learning (M-Learning) was introduced to enhance the level of success in teaching and learning process. M-Learning in Malaysia classified as very new in terms of implementation. It emphasis the ability to transfer the teaching and learning process not to strictly depending on physical location of T&L process is carried out (Kukulka-Hulme & Traxler, 2005). Standard Method of Measurement 2 (SMM2) is a main reference for Building Works Measurement (BWM) courses and must be brought by all students during class. SMM2 comes in a physical book form. The clauses in SMM2 are various and related to almost all content in BWM syllabus. The use of SMM2 in class is a must. The researchers found that there are cases where by student left behind their SMM2. This can interrupt the student understanding during T&L process. The main objective of the development of this application is to overcome that matter. That was the problem statement which initiated this project. The 'QS Junior' aimed to ease the student in referring SMM2 even the book is not in their hand, provided that smartphone and internet access are available. The student can simply use their phone to download the application from Play Store or scan a QR barcode allocated around the studio or their lecture venue (during face to face class) and start opening SMM2 online.

'QS Junior' mobile application developed by using 'App Builder Appy Pie' software. It is one of the advance mobile application developer software (App Maker) available in a market. Appy Pie allows user with no computing skill to develop their own mobile application for major smart phone platform; Android, iOS, Fire OS and Window Phone. The developed application later on can be publish in Play Store and iTunes. 'QS Junior' also become their mobile notes as all basic skill and knowledge needed for this course can be referred at a finger tips. This application is user friendly as it can be access by user and student via their Android or iOS smartphone.

The content of this application was chosen from a major task in all BWM course starts from 'taking off' until the establishment of 'Bill of Quantities' (BQ) as QS Junior showing a typical BQ samples for common project. The keypads in each feature links to detail explanation, sample and relevant information to guide student during their learning process right from their smart phone.

The QS Junior consists of twelve (12) main features named Menu, Standard Method of Measurement 2 (SMM2) portal, Taking Off List, Description, BQ samples, Toolbox, Drawing, Conversion Table, Calculator, Gallery and About Us. Main menu features displays all menu and keypads. SMM2 portal is a core and main content of this application.

Impact

This project gives impact to the 4 various parties that were the major users of this application:

- 1) Lecturers
 - i. The QS Junior application considered as handy and quick reference for BWM lecturers while teaching the course.
 - ii. The lecturers are exposed and applying the information technology in teaching and learning
- 2) Students
 - i. The PKB Quantity Surveying student can utilise this mobile learning aids during the Building Works Measurement course lecture.
 - ii. This application also can be used by all QS students from other higher institutions as the content meets the needs of quantity surveying practices in Malaysia.
- 3) Institutions
 - i. This project supporting the mission of Politeknik Kota Bharu in encouraging the lecturers to come out with innovation and research to empower the lecturers knowledge and skills
 - ii. Contributing to Centre of Technology (COT) report as Diploma in Quantity Surveying is the Niche Area for Politeknik Kota Bharu
- 4) Industry
 - i. Royal Institute of Surveyors Malaysia (RISM) also supporting the innovation and research in quantity surveying discipline. The researcher aim to upgrade the application from time to time and looking forward to collaborate with RISM in a future
 - ii. All parties in the in the construction industry can use this application as a reference such as Quantity Surveyors, contractors and quantity surveying practitioners.

Commercial Value

The researchers aim to place the QS Junior in an application platform as a paid application with certain fees via downloads. This will beneficial to researchers and the users among quantity surveying discipline when both sides can get the benefits and advantages of this application.

Conclusion

The main purposes of this study are to meet the lined up objectives of; (1) to develop 'QS Junior' mobile application and (2) to know the level of acceptance of the mobile application. The finding of this research shows that the researchers have successfully met the objectives. Overall, the acceptance level towards this 'QS Junior' mobile application is positive. This result shows that Quantity Surveying Diploma Program student are ready to fully utilizing this mobile learning aids during the Building Works Measurement course lecture. At the same time, the student also can adapt with the mobile learning in teaching and learning process. The researchers hope that this 'QS Junior' mobile application will be acceptable and utilised by student from other polytechnics in Malaysia and other higher education. This research can be expanded by taking several quantity surveying software available in market such as Revit, CostX or even current Building Information Modelling (BIM). The researchers also hoping that this application will soon widely utilized by more users especially quantity surveyors and related parties involved in Malaysia construction field.

References

- Adam, J., & Morgan, G. (2007). Second Generation E-Learning: Characteristics and Design Principles for Supporting Management Soft-Skill Development. *International journal on E-Learning*. ProQuest Education Journals.
- Creswell, J. W. (2010). *Educational research - Planning, Conducting, and Evaluating Quantitative and Qualitative Research* (4th Ed). New Jersey: Pearson Merrill Prentice Hall.
- Donald, J.L. (2003). *Wireless Messaging Demystified : SMS, EMS, MMS, IM and Others*. United States: McGraw-Hill Profesional.
- Jonassen, D.H. 2000. *Computers As Mindtools For Schools: Engaging CriticalThinking*. 2nd ed. New Jersey: Merrill Prentice Hall.
- Kukulska-Hulme, A., & Traxler, J (2005). *Mobile Learning: A Handbook For Educator And Trainers*. London, UK:Routledge.
- Mohamad Najib, A. G. (2003). *Reka bentuk tinjauan soal selidik pendidikan*. Johor: Penerbit Universiti Teknologi Malaysia.
- The Institution of Surveyors Malaysia (2004). *Malaysian Standard Method of Measurement of Building Works 2*: Winston Enterprise

THE JOME CARD GAMES: FROM TEACHING INNOVATION TO COMMERCIAL GAME

Johan bin Ismail

Faculty of Agricultural Sciences and Forestry, Universiti Malaysia Kelantan
ijohan@upm.edu.my*

Nur Eliza binti Abd. Rahman¹, Nurdiana binti Ahmad Denil¹, Rozihan bin Mohamed², Ahmad Nasir bin Mohd. Yusoff²

¹Universiti Putra Malaysia, 97008 Bintulu, Sarawak,

²UPM Serdang, Malaysia

nurelizaar@gmail.com?; nurdiana@upm.edu.my³, rozihanm@upm.edu.my⁴;
ahmadnasir@upm.edu.my⁵

Highlights: JOME and JOME Edugamia are brand-new card games that provides social, strategy and competitive game play experience to the young and urban adults. JOME is an accumulating-type card game that is played with a specially printed deck. The engaging JOME game mechanics was principally designed for the education purpose of university students, with intention to reinforce the understanding of the evolution of the animal kingdom. The unique and engaging game mechanics was designed to support the education intention, thus developing JOME Edugamia. Finally, by reimagining the game for everyone to play, JOME was developed. When playing JOME, players need to plan and strategize at every move throughout the game, hence improving patience and concentration. As JOME is also a joyful game, when played among friends, it improves relationships and social skills.

Key words: JOME, Card-game, Teaching and Learning, Invertebrate, Animalia

Introduction

A game is "a physical or mental contest that has specific rules, with the aim to amuse or reward the gamers" (Zyda, 2005). Hays (2005) provides the following definition of a game or computer game: "A game is an artificially constructed, competitive activity with a specific goal, a set of rules and constraints that is located in a specific context." A game does not represent reality. It is a constructed activity that resembles portions of reality. Games are interactive, which promotes behaviors like individual control, trial- and-error and constant change (Birnbaum, 1982). Games provide situated experiences in which players are immersed in complex problem-solving tasks (Squire et al., 2005). Educational card games can be an asset in the classroom, stimulating active imaginations and enquiring minds through play. With the development of new and novel variants on traditional card game rules, the role that card games can play in learning activities has developed over the last few years from simply supporting arithmetic and linguistic teaching in the form of flash cards to playing an active role in science lessons, providing real information about science subjects that can be used as the basis for classroom discussions and project work (Smith and Munro, 2009).

Description and Context of the Innovation, Design and Product Development

The JOME card-games gathers strategy, social and competitive experience, all in a deck. JOME is presenting an accumulating type of gameplay that can be played from two to six players each round. The JOME card-game is offering the world a fun, immersive, challenging and competitive playing experience, while JOME Edugamia is adding the educational benefit. JOME comes with 126 cards (JOME) and 144 cards (JOME EDUGAMIA) and the player with the most points at the end of the game wins. As the players needs to plan and strategize at every move, it will improve patience and concentration as well as the social skills. Playing JOME is also joyful especially with family and friends. And while playing JOME Edugamia, students will get to improve their understanding on the evolution of invertebrate animals.



Figure 1. (A) Jome Card-Game (B) Jome Edugamia Card-Game (C-D) Playing JOME card-game

Importance to Education

JOME was designed to reinforce students understanding on the major characteristics of animal evolution with emphasis on the invertebrates. Major concepts such as germ layers, embryonic development and coelomic development was reinforced in the game. A unique and engaging game mechanics was designed to support the education intention, thus developing JOME Edugamia. Finally, by reimagining the game for everyone to play, JOME was developed.

Usability, Advantage and Marketability

The card games market is forecasted to grow by the CAGR of 8.7% (2019 to 2025), thus showing potential of JOME for commercialization. The JOME card-game was designed specifically to be played by the masses, especially individuals of the age 13 years old and above. The JOME's engaging accumulating-type game mechanics will bring a fresh experience as current card games are the shedding-types. The JOME card game can be expanded with unlimited theme capability. Because of Covid-19 Pandemic and restriction for physical interaction, JOME was only able to be tested once but intensely with six students from UPM, and they were interviewed after testing to answer a set of question based on Likert-scale score (Table 1). Based on their responses, the JOME card-game had received a positive reception.

Table 1: Response from test-players (n=6) during intensive game testing of JOME card-game based on Likert-Scale score (1=strongly disagree and 5=strongly agree)

No	Statement /	Average Score
1	The design, shape, and color of this JOME game card is interesting.	4.67 ± 0.47
2	The JOME game mechanic is very interesting.	4.33 ± 0.94
3	I feel excited and excited while playing the JOME card game.	4.83 ± 0.37
4	I have an addictive feeling to play another JOME game.	4.33 ± 0.75
5	This JOME game card is an innovation that I have never encountered before.	4.50 ± 0.76
6	I get bored while playing the JOME game.	1.17 ± 0.37
7	I have fun while playing the JOME game.	4.83 ± 0.37
8	I must strategize while playing JOME to get the win.	4.67 ± 0.37
9	The JOME game gives all players an equal chance to win (depending on strategy and luck).	4.00 ± 0.82
10	The JOME game is too complicated for me to understand.	1.33 ± 0.75

The JOME card-games has been registered for copyright protection and filled to MY-IPO in 2020. Currently, the JOME project is entering a new phase for commercialization under the Putra Science Park Innohub Program 2021-2022. JOME is expected to be in the marketplace very soon.

Acknowledgement

This project is supported by Innohub Grant (9003284) and GIPP Grant (9323757) Universiti Putra Malaysia.

References

- Bacca, J., Baldirid, S., Fabregat, R. Graf, S. & Kinshuk. (2014). Augmented Reality Trends in Education: A Systematic Review of Research and Applications. *Educational Technology & Society*, 17(4), 133-149.
- Birnbaum, R. (1982). Games & Simulations in higher education. *Simulations & Games*, 13 (1), 3-11.
- Hays, R. T. (2005). *The Effectiveness of Instructional Games: A Literature Review and Discussion*. Orlando: Technical Report 2005-004 Naval Air Warfare Center Learning Systems Division.
- Smith, D.R. & Munro, E. (2009). Educational Card Games. *Physics Education*, 44(5): 479-483.
- Squire, K., Giovenetto, L., Devane, B., & Shree, D. (2005). From users to Designers: Building a self-organizing game-based learning environment. *Techtrends*, 49(5), 34-42.
- Zyda, M. (2005). *From visual simulation to virtual reality to games*. IEEE Computer.

MY E-VOCABULARY PROFILE (MEVP): TEACHER'S PERSPECTIVE ON ITS USABILITY

Norshazrina Sabri

Universiti Malaysia Kelantan, Bachok, Malaysia
shazrina@umk.edu.my

¹Liyana Ahmad Afip, ²Aveleena Afzan Hassan, ³Nursyuhada Zakaria

^{1,2}Universiti Malaysia Kelantan, Bachok, Malaysia, City, Country

³Universiti Teknologi Mara (UiTM) Johor, Kampus Pasir Gudang, Johor, Malaysia
¹liyana.a@umk.edu.my, ²aveleena@umk.edu.my, ³syuhadazakaria@uitm.edu.my

Highlights: My E-Vocabulary Profile (MeVP) is a compilation of students' learning progress of new English vocabulary benefitting the usage of Vocabulary.com. Each student would have a different MeVP wordlist depending on their language proficiency. This paper intends to present preliminary findings on the usability of MeVP for intermediate students. The teacher used Vocabulary.com for a pre-reading activity and claimed that the students were reluctant to initiate their list. However, they were motivated to achieve 100% mastery of the words although it requires several attempts. Therefore, there is a need for further study on the usability of MeVP for advanced students.

Keywords: *Vocabulary, electronic vocabulary profile, higher education, ELT, autonomous learning*

Introduction

Previously, the planning and development of English subjects in Malaysia focused on four language skills: listening, speaking, reading, and writing based on what students need in their everyday lives without a clear description of proficiency level. As a result, there is no continuity from one stage of learning to another, ambiguous definitions of learners' capability, and difficulty in comparing students' performance from one learning institution to another. The introduction of the English language Education Roadmap 2015-2025 (The Roadmap) enforced the Common European Framework of Reference as a performance standard for all levels of education in Malaysia and, most importantly, internationally recognised.

Background of MeVP

MeVP is proposed to be introduced for undergraduates who are enrolled in English courses as university compulsory courses. MeVP is a continuous process of collecting information on vocabulary that students' have learned throughout the semester from the courses they have taken depending on their field of studies. MeVP can be conducted outside of the English class time. University students should know that they need to acquire at least 3250 words for them to achieve CEFR B2 (Milton, 2013). Although vocabulary is not a part of assessment, vocabulary knowledge is highly correlated with performance in reading, speaking, listening, and writing (Milton & Alexiou, 2009).

In Malaysia, it is targeted in The Roadmap that university students should reach B2 level once they graduate to meet the workforce requirement. However, this target is difficult to achieve if students have a limited vocabulary, which will affect their English proficiency. Nur Fatima, Nur Ashikin, and Noraziah (2017) reported that proficient learners tend to have a wider vocabulary range than the less proficient. Therefore, vocabulary mastery is essential to help students become independent and confident users of English.

Previous research on how ICT or blended learning approach affects students' vocabulary mastery has reported various positive effects. Vasbieva et al. (2016) investigated the effects of a blended learning approach on students' vocabulary achievement. Based on the pre-and post-tests conducted, it was reported that students' vocabulary achievements had improved significantly. Similar findings were also observed in Krishnan and Yunus (2019) where they found that blended learning helped low proficient learners enhance their vocabulary knowledge. These studies employed online resources and materials such as videos, games, and images.

Relevance of MeVP to education

MeVP encourages autonomy in learning where students can decide reading materials that are relevant to them. Students also need to practice self-evaluation in making decisions to choose the new words found in the text. Mastering a vast range of vocabularies in a second language helps learners read, listen, write and speak well. One of the advantages of MeVP is learners can use the words to create their profile, consequently exposing them to the use of the words in different contexts. This will challenge them to use the words creatively to make their profile interesting. Educators also benefit from MeVP in which they can gain access to the learners' profile which also contains their academic background. Based on that information, educators can plan the lessons accordingly to suit their level. MeVP is created online so both learners and educators can easily access all the necessary information for future reference.

Preliminary findings and recommendations

The teacher used Vocabulary.com for a pre-reading activity instead of a language enhancement activity because the students were reluctant to find their own text and initiate their list. It indicates that students failed to relate the usability of MeVP outside of English classroom. Discussing the response from the students, the teacher mentioned that the students were motivated to achieve 100% mastery of the words although it requires several attempts. The students were also interested in exploring more features offered by Vocabulary.com such as Vocabulary Jam where they can create their own group. However, this opportunity was not able to be explored due to limited knowledge of the application and time constraint.

In sum, Vocabulary.com has a huge potential to be utilized in ESL classrooms. Considering that there are different levels of English acquisition among the students, teachers are suggested to provide different levels of guidance. For instance, lower level students should be guided closely including providing suitable articles or texts and also doing frequent checking on their work. While for intermediate and advanced students, they can be encouraged to find their own reading materials and the teacher can facilitate so that the aim to promote independent learning is achieved. E-certificate can also encourage them to give their full commitment and consequently succeed in building vocabulary that will be useful for them in the future.

References

- Krishnan, P. D., & Yunus, M. M. (2019). Blended CEFR in Enhancing Vocabulary among Low Proficiency Students. *Arab World English Journal (AWEJ) Special Issue on CALL* (5), 141-153. DOI: <https://dx.doi.org/10.24093/awej/call5.11>
- Milton J., Alexiou T. (2009). Vocabulary Size and the Common European Framework of Reference for Languages. In: Richards B., Daller M.H., Malvern D.D., Meara P., Milton J., Treffers-Daller J. (eds) *Vocabulary Studies in First and Second Language Acquisition*. Palgrave Macmillan, London. (194-211)
- Milton, J. (2013). Measuring the contribution of vocabulary knowledge to proficiency in the four skills. *EUROSLA Monograph series 2: L2 vocabulary acquisition, knowledge and use*. (57-78)
- Nur Fatima Wahida Mohd Nasir, Nor Ashikin Ab Manan, & Noraziah Azizan (2017). Examining the Relationship Between Vocabulary Knowledge and General English Language Proficiency. *ESTEEM Journal of Social Sciences and Humanities*, 1, 15-22.
- Vasbieva, D. G., Klimova, I. I., Agibalova, E. L., Karzhanova, N. V. & Birova, J. (2016). Enhancement of Students' Vocabulary Learning Through a Blended Learning Approach. *International Electronic Journal of Mathematics Education*, 11 (5), 1195-1203.

MYOT_G: AN INNOVATIVE AND INTERACTIVE E-TEACHING METHOD FOR PRE-UNIVERSITY STUDENTS

Hutkemri Zulnadi

University of Malaya, Kuala Lumpur, Malaysia
hutkemri@um.edu.my

Raihan Zainudin, Mohd Zahurin Mohamed Kamali

University of Malaya, Kuala Lumpur, Malaysia
raihan.zainudin@365.um.edu.my, mzmk@um.edu.my

Highlights: MyOT_G stands for "My Online Teaching with GeoGebra". The objective of developing MyOT_G is mainly to solve the problem of lacking mathematical reasoning skills among pre-university students. It is an online teaching method via Microsoft 365. GeoGebra software also plays an important role in this teaching method. The GeoGebra Applet is developed specifically for the propositional logic topic. The propositional logic law and identities which is designed in this applet, are De Morgan's Law, Conditional, Converse, Inverse, Contrapositive and Biconditional. The approach of the Venn Diagram is applied in delivering this topic. A total of 15 students, 10 lecturers, and 4 experts from a pre-university, were interviewed to evaluate MyOT_G development for the topic of propositional logic. The results showed all the categories of respondents agreed that the MyOT_G is suitable for lecturers, and students in the process of teaching and learning propositional logic. In addition, this study can also have an impact on lecturers in improving their teaching technology skills that can meet the current needs of students.

Keywords: *Development, GeoGebra, mathematical reasoning, propositional logic, Teaching Method, technology skills.*

Introduction

Since 2018, the world has entered the era of the fourth-generation industrial (IR 4.0). In this era, electronics and information technology are introduced to be utilized to automate production. Automation technology is linked to cyber technology, in which "it is a trend of data automation and exchange in manufacturing technology" (Lase, 2019). Then, the virtual world, in the form of humans, machines, and big data, the Internet of Things (IoT), is getting more popular in this 21st century. All these tremendous shifts changed the way we live and work essentially. As people lives changed, education is surely also affected. Moreover, the quality of education becomes a benchmark in determining the success of a country. It encompasses the quality of educators, which the educators play the main role in education, to ensure a creative, innovative, and competitive generation is produced (Lase, 2019). The teaching and learning environment should be reviewed and improvised so that it is parallel to the current era and compatible with the current generation. Not to be left behind, Malaysia is also looking forward to being among the best in education. Malaysia aspires to be in the top third in terms of performance in PISA and TIMSS by 2025. In line with the aspirations, the Malaysia Education Blueprint 2013-2025 has outlined specifically for students to have a basic knowledge of mathematics and science and even master much more. Thinking skills are necessary for acquiring knowledge so that a love for inquiry and lifelong learning could be embedded in the individual students. The skills are also important in enabling students to link different pieces of knowledge that they obtained. Therefore, students need to master a range of important cognitive skills; problem-solving, reasoning, creative thinking, and innovation. Ultimately, new knowledge could be discovered and superb innovation could be produced and commercialized. (Ministry of Education of Malaysia, 2013).

Mathematics is one of the most vital subjects in education (Ic and Tutak (2018). Moreover, it helps in developing logical thinking (Bass & Ball, 2018). Mathematics and logical thinking are related. Both share the idea to retrieve and apply normative rules, to draw conclusions on the basis of given premises, and to process abstract or symbolic content (Morsanyi & Szűcs, 2015). In real-world problems, common mathematics is used vastly ranging from arithmetic, algebra, calculus, statistics, and probability. Yet, there is another area, which is significant called "propositional logic" (Pace, 2012). This covers the idea of reasoning the truth and falsity which is important specifically in designing digital circuits and computer programs. However, the topic of propositional logic seems lacking in mathematics school. In addition, most teachers prefer traditional methods in teaching mathematics which involve algorithmic and procedural approaches. Thus, this leads students to memorise without understanding it well. As a result, the students become lacking in their mathematical reasoning skills. Furthermore, they do not appreciate it because they could not find any solid reason why they need to learn the topic and how it is related to mathematics.

Content

MyOT_G stands for "My Online Teaching with GeoGebra". It is an online teaching method via Microsoft 365, which involves Microsoft Teams, Microsoft Sway, Microsoft Whiteboard, and Microsoft OneNote. GeoGebra software plays an important role in this teaching method because of its user-friendly features, open-source software and available on mobile devices. Therefore, teachers and students can reach myOT_G anytime and anywhere. Moreover, the current generation of students is very keen on tools or applications. Therefore, MyOT_G can increase students' interest in mathematics.

In MyOT_G, the GeoGebra Applet is developed specifically for the Propositional Logic topic. The approach of the Venn Diagram is applied in delivering this topic. Thus, in the MyOT_G, the topic of propositional logic is merged with the other various branches of Mathematics, such as algebra, sets, and matrix. This fusion across different branches in mathematics is vital to trigger the students to think creatively and critically and apply it to real problems.

Besides, the development of MyOT_G is also expected to increase mathematical reasoning among pre-university students as well as to meet the target set by the Ministry of Higher Education. In addition, this study gives an impact on the lecturers and teachers at the pre-university level to improve their skills in the use of technology and adapt to the needs of students. This will produce a new batch of students who are not only computer literate with the latest technologies but also has the skills to apply technologies such as Geogebra software, in their learning activities.

Currently, MyOT_G is in the process of registering Intellectual Property through the University of Malaya. In addition, there are plans to market these teaching methods through various social media, such as LinkedIn, Facebook, Instagram, YouTube, and Twitter to introduce and provide exposure to interactive teaching and learning to educators at any school level. This is because changes need to be made immediately.

Results

Need Analysis Phase

A total of 5 pre-university students were interviewed for the needs analysis phase in the DDR approach. The findings of the needs analysis show that students have problems in learning propositional logic topics. Problems found among students such as using formulas as well as relating examples of situations in real life. Students also stated that lecturers usually use traditional teachings such as using whiteboards or lecture slides. However, mathematical software is rarely used in the teaching and learning process. Students have suggested improving the teaching method of lecturers by using technology on the topic of propositional logic such as using software that can demonstrate formulas and situations in practice. Students also prefer teaching method that involves student activities in the classroom.

A total of 6 pre-university lecturers were interviewed. The findings of the needs analysis show that students have problems in learning propositional logic topics. Problems found among lecturers and teachers such as using formulas as well as relating examples of situations in real life to the students' understanding. Lecturers use traditional teaching methods. However, mathematical software is rarely used in the teaching and learning process. Lecturers and teachers have suggested improving the teaching method of lecturers and teachers by using technology on the topic of propositional logic such as using software that can be demonstrated formulas and situations in practice. Lecturers and teachers also prefer to create a teaching method that involves student activities in the classroom.

Design and Development Phase

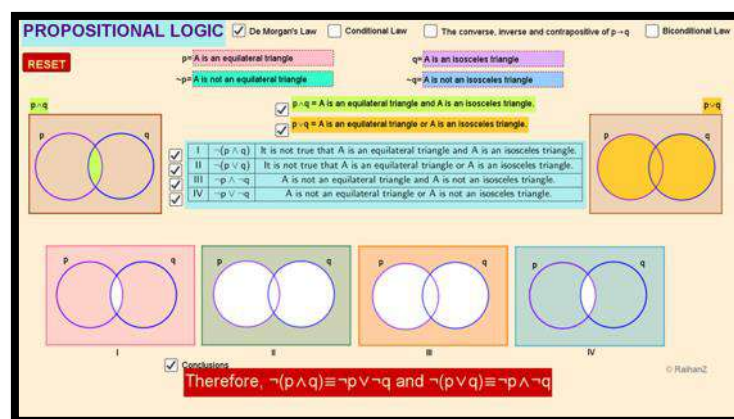

Figure 2. Design of MyOT_G

The development of MyOT-G has been carried out gradually, and currently, MyOT_G has entered to be able to provide the information needed for the teaching of propositional logic. Emphasis on the aspects desired by students has been included in the criteria for developing MyOT_G such as being able to show formulas and situations in real life in mathematical software.

The selection of GeoGebra software is considered the most appropriate by the research team because it can show the actual formula and situation in the software. In this study, The GeoGebra Applet is developed specifically for the topic of propositional logic. The laws of propositional logic that are designed in this applet, are De Morgan's Law, Conditional Law, Converse Law, Inverse Law, Contrapositive Law, and Biconditional Law. Those laws are chosen to be designed in this applet because of its difficulty to understand and convey. It is also designed with the purpose to improve students' reasoning skills.

Evaluation Phase

In the evaluation phase of MyOT_G, 4 experts, 10 Lecturers, and 15 Students were involved. The results showed that the agreement of experts, lecturers, and students about the MyOT_G method is high. This is marked by the average expert agreement in terms of MyOT_G interface ($M = 4.71$) and MyOT_G content ($M = 4.61$). The average agreement of lecturers in terms of MyOT_G interface ($M = 4.40$) and MyOT_G content ($M = 4.27$) as well as the agreement of students were found in terms of MyOT_G interface ($M = 4.50$) and MyOT_G content ($M = 4.43$). Based on interviews with experts, lecturers and students found a positive view on the use of MyOT_G in the topic of propositional logic.

Table 1: Pre and post-test result for experimental and control group design

Group	The reasoning of Propositional Logic		Z	Sig.
	Pre-test	Post-test		
Experiment Group	11.13	24.13	3.410	0.001
Control Group	9.67	20.20	3.298	0.001

A Quasi-Experimental design also has been conducted to determine the effectiveness of MyOT_G on the reasoning of the propositional logic topic. A total of 30 pre-university students are involved; 15 students in the experimental group and 15 students in the control group. The results of the Wilcoxon Signed Ranks Test showed there are significant differences in the students' reasoning of propositional logic before and after using the MyOT_G method as well as the traditional method. Yet, students who learned using the MyOT_G method were better in the reasoning of propositional logic rather than students who learned using the traditional method.

Acknowledgment

The authors would like to acknowledge the financial support provided by the University of Malaya under the UM Liter Grant 2021 (RU013W-2021).

References

- Bass, H., & Ball, D. L. (2018). Review of Does Mathematical Study Develop Logical Thinking? Testing the Theory of Formal Discipline. *International Journal of Research in Undergraduate Mathematics Education*, 4(3), 442–447. <https://doi.org/10.1007/s40753-018-0076-7>
- Ic, U., & Tutak, T. (2018). Correlation between Computer and Mathematical Literacy Levels of 6th Grade Students. *European Journal of Educational Research*, 7(1), 63–70.
- Lase, D. (2019). Education and Industrial Revolution 4.0. (August), 0–15. <https://doi.org/10.24114/jh.v10i1>
- Ministry of Education of Malaysia. (2013). Malaysia Education Blueprint 2013–2025. *Education*, 1–268. <https://doi.org/10.1016/j.tate.2010.08.007>
- Morsanyi, K., & Szűcs, D. (2015). The link between mathematics and logical reasoning: implications for research and education. *The Routledge International Handbook of Dyscalculia and Mathematical Learning Difficulties*, 101–114.
- Pace, G. J. (2012). *Mathematics of Discrete Structures for Computer Science*. <https://doi.org/10.1007/978-3-642-29840-0>

GLOBAL UMRAHAJI GAME (GUG)

Prof. Dr. Azman Ab Rahman

Universiti Sains Islam Malaysia, 71800 Nilai, Malaysia
azman@usim.edu.my

Afaf binti Sukari, Mohamad Anwar Zakaria, Muhammad Faiz Abd. Shakor, Nurul Nadia binti Nozlan

Universiti Sains Islam Malaysia (USIM), 71800 Nilai, Negeri Sembilan



afafsukari97@gmail.com, anwarzakaria8055@gmail.com, faizshakorkisas@gmail.com, nunadianurul@gmail.com

Highlights: Global UmraHaji Game (GUG) is introduced using the concept of gamification to increase understanding and knowledge of the method of performing umrah and hajj in detail to the community as early as childhood. In addition, GUG is also a scientific board game with umrah and hajj theme to apply the concept of entertaining and interactive learning (fun learning) in umrah and hajj worship education, GUG also can be used as a teaching aid in Islamic education at school and at the same time can strengthen the relationship with each other. GUG is divided into two versions; the physical version and the digital version.

Key words: *Global UmraHaji Game (GUG), gamification, umrah, hajj, fun learning, education to one line.*

Introduction

The performance of Umrah and Hajj requires a clear understanding in terms of the pillars, obligatory, things that are prohibited during ihram and the ways of performing umrah and hajj. However, the community and students still do not have enough knowledge about the correct method of performing umrah and hajj and do not even understand and deepen the method of performing umrah and hajj as well as possible. Therefore, the community and students need to be given good preparation and a picture of the situation and implementation of umrah and hajj itself. The community and students need to acquire sufficient knowledge to be able to be a guide when performing umrah and hajj. Thus, the Global UmraHaji Game (GUG) was introduced using the concept of gamification to increase the understanding and knowledge of the methods of performing umrah and hajj in detail to the community and students as early as childhood. The main purpose of this game is to provide education to the community, especially primary and secondary school students and Muslims in Malaysia in particular. The advantage and uniqueness of this product is because it is based on the syllabus of Islamic education subjects based on the Secondary School Standard Curriculum (KSSM), Primary School Standard Curriculum (KSSR), Islamic Shariah Education Syllabus form 4, KAFA Year 6 Ibadah Subject and Hajj Book, Umrah and Ziarah issued by Tabung Haji. GUG is divided into two versions, the physical version and the digital version. The physical version is in the form of a game board and the use of dice and cards. While the digital version is in the form of games using mobile gaming applications and Augmented Reality (AR) applications. GUG also serves as a teaching aid for Islamic education subjects and training materials for mutawwif courses and hajj courses implemented by relevant agencies. GUG is believed to be able to increase the knowledge and understanding of the community and students on the importance of performing umrah and hajj correctly and perfectly.

VERSION	PRODUCT
PHYSICAL VERSION	<p>1) BOARD GAME</p> 
DIGITAL VERSION	<p>1) MOBILE GAME APPLICATION</p> 
	<p>2) AUGMENTED REALITY (AR) APPLICATION</p> 

Content

GUG is built based on the Secondary School Standard Curriculum (KSSM) for the subjects of Islamic Education and Islamic Shariah Education form 4 as well as the book of Question and Answer of Ibadah Haji, Umrah and Ziarah published by Tabung Haji. This game is suitable to be played by 2 to 4 players at one time. Each player will start the game as a Muslim individual who wants to perform umrah and haji. Throughout the game, players will go through the boxes that explain the procedure for performing umrah and haji, both practically and verbally. Players will also be tested related to knowledge about umrah and haji through GUG Mind Test questions, Pillars Questions, Dam Questions and Badal Haji Questions provided. Players who successfully answer the questions will get rewards that have varying score values. This GUG game will end when the player reaches the end of the box as soon as he answers the Badal Haji question. The winner of this game will be determined based on the maximum rewards that have been collected. At the end of the game, players will get a clear picture of how to perform umrah and haji perfectly.

This GUG game can be played with two methods. The first method is to use board games, dice and also card. Through this method, players at the same time can use the Augmented Reality (AR) Global Umrahaji Game (GUG) application to scan and view the practical procedures for the pillars or obligatory of umrah and hajj. Scanning using this AR GUG application can be done while the player stops in any of the Pillars or Obligatory of Umrah and Hajj squares while playing. Through the AR GUG application, players will be able to find out how the actual procedure of practising the pillars and obligatory of umrah and hajj is performed. The second game method is to play using the Global Umrahaji Game (GUG) mobile game application via smartphone.

The first product based on Islamic education, Umrah and Hajj in Malaysia, and in the world. • Based on Book of Ibadat Haji Umrah and Ziarah by Tabung Haji.

1. Based on Syllabus for Ibadah KAFA subject, standard 6.
2. Based on Islamic Education syllabus for standard 1,2,4,5 and form 1,2,4,5.
3. Based on Syllabus for Syariah Islamiah Education subject for form 4.

This game is important to education.

1. **The Concept of Fun Learning** : Creating fun learning concept in education by using Umrahaji board game as a learning aid tool.
2. **PAK21 Patterned** : Very relevant with the pattern of Pendidikan Abad Ke-21 (PAK21), thus Umrahaji board game creates an active learning atmosphere and interactive communication between teachers and students.
3. **Training of Related Agencies** : One method of training for mutawwif, pilgrimage mentor and congregation in regards to the correct implementation method of Umrah and Hajj and learning Umrah and Hajj knowledge practically.

A scientific board game with umrah and hajj theme to apply the concept of entertaining and interactive learning (fun learning) in umrah and hajj worship education theoretically and practically. Through the mobile game and AR GUG application, players will be able to find out how the actual procedure of practising the pillars and obligatory of umrah and hajj is performed. The game is becoming a tool or learning aid in school and courses related to Umrah and Hajj in Umrah and Hajj travel, including educational institutions.

Commercialization Potential

Inside and outside the country, this game has potential to Malaysian Ministry of Education, Pustaka Ilmu Bakti, Pustaka Rakyat, public library, desa library, Yayasan Inovasi Malaysia, SME Corps, collaborator with Brunei and Thailand universities and KL Braille Resources. The agency related to the product is Umrah & Hajj Management Agencies (Kelab Taha, Tabung Haji, Angsana, Simply, Al-Quds, Tursina Travel, etc). The target customers are primary and secondary students aged 7 to 17, students in city and rural area, special education students, mutawwifs, educators, disabled, muallaf, asnaf, umrah and hajj agencies, society and rural community

Acknowledgement

We would like to thank the Yayasan Inovasi Malaysia (YIM) for fully funding this study under the High Impact Programme 6 (HIP 6), for the innovation project development of Global Umrahaji Game (GUG). The chief researcher would also like to express his appreciation to the members of the research team of this study for their cooperation.

References

- Alliance for Excellence in Education (All4Ed). (2009). High school dropouts in America. www.all4ed.org/files/GraduationRates_FactSheet.pdf (Diakses pada 28 Desember 2016).
- Hamari, J., Koivisto, J., & Sarsa, H. (2014, January). Does gamification work?—a literature review of empirical studies on gamification. In 2014 47th Hawaii international conference on system sciences (pp. 3025-3034). IEEE.

LEARNING GRAPH THEORY BY USING ROTHE-Q INNOVATION METHOD

Nur Izzati Abd Aziz @ Mughni,

Faculty of Education, University of Malaya, Kuala Lumpur, Malaysia
zatimughni@gmail.com.my

Kalaiarasan A/L Subramaniam¹, Nik Afikah Nik Adnan¹, Noorul Afiah Mohamed Shuaib¹, Nur Fatehah Zaharim¹, Hutkemri Zulnaidi²

¹Faculty of Education, University of Malaya, Kuala Lumpur, Malaysia

²Department of Mathematics and Science Education, Faculty of Education, University of Malaya, Kuala Lumpur, Malaysia

noorul.afiah@gmail.com, fatehah95@gmail.com, arasanlondon@gmail.com, nikatikah4062@gmail.com
hutkemri@um.edu.my

Highlights: This innovation is a teaching and learning innovation about Network in Graph Theory, the new topic in Mathematics Form 4 syllabus for KSSM. This innovation consists of three main components; Roola Games, Graph Theory Online application, and Quizizz application. The final result shows that this innovation successfully improved students' understanding level in the concept of graph theory.

Keywords: effective teaching method, graph theory, teaching and learning graph theory.

Introduction

Malaysia's Curriculum has been revised to emphasis on the students-centred learning and focuses more on problem solving, project-based assignment, and implementing performance assessments. The latest curriculum for secondary schools, named Standard Based Curriculum for Secondary Schools (KSSM) were revised to drive a balanced set of knowledge and skills among the students. One of the new topics in Mathematics Form 4 Syllabus is Network in Graph Theory. This topic has challenged the teachers to provide an effective teaching method to the students in order to relate this topic with their real-life situations. Students tend to get confused to solve problems involving networks when they do not understand the basic concepts of graph theory. Teachers must provide an interesting activity for the students to have a better understanding about networks especially when they have a great learning experience that involves their real-life situations.

Content

In this innovation, we combined three different activities to achieve a more effective engagement and increase students' understanding for this topic. This innovative teaching method is a blend of educational technology and offline game which will attract students' interest to participate. We used Roola Games, Graph Theory Online application, and Quizizz application for this innovation. Roola Games is a new innovative offline game that has been created to make students familiar with the new terms in this topic and teachers also can use this game to model the real-life situations to the students. For this innovation, firstly we conducted pre-activity by using Quizizz application to determine the students' level of understanding before this innovation was implemented. Then, we played Roola Games in the classroom to introduce some new terms and relate this topic with real-life situations. Next, students need to use Graph Theory Online application to convert the network they created in the Roola Games into a diagram in the application. There will be some discussions with the students at this point to create a two-way communication, and to give the best teaching and learning experience to the students. Lastly, we conducted post-activity by using Quizizz application again to determine the effectiveness of this innovation.

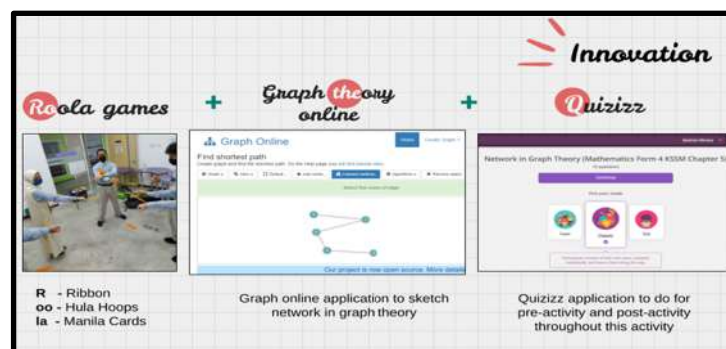

Figure 1: Combination of Activities in Rothe-Q Innovation

This innovation is considered as an important innovation to be used in mathematics classrooms to encourage the students' creativity in solving problems and making decisions. It also helps teachers and students to have a great learning experience about graph theory in an interactive way. Furthermore, students also can easily relate this topic with their real-life situations and solve problems involving networks without any difficulties when they mastered the basic concepts of this graph theory.

Table 1: Result of correct answer in Quizizz application

	Pre-activity		Post-activity	
	Marks	Percentage (%)	Marks	Percentage (%)
Student 1	6	60	7	70
Student 2	5	50	8	80
Student 3	4	40	6	60
Student 4	4	40	7	70
Student 5	4	40	7	70
Student 6	4	40	6	60
Student 7	3	30	7	70
Student 8	3	30	5	50
Student 9	2	20	7	70
Student 10	2	20	6	60

Our findings indicate that the result of the students answered correctly after the innovation implemented in the post-activity is increased compared to the pre-activity result. Hence, we conclude that this innovation gives the best teaching method for learning graph theory in the mathematics classroom.

Acknowledgement

This wonderful innovation would not have been possible without the involvement and support from some important person around our team members. We are overwhelmed in all humbleness and gratefulness to acknowledge our depth to all those who have helped us to put these ideas, well above the level of simplicity and into something concrete. We also would like to thank our parents who gave a lot of moral, physical and financial support to make this innovation become reality. Not to forget, our classmates of Postgraduate Diploma in Education 2020/2021, who always share many thoughts and feedback along this innovation development process. Above all, praises and thanks to the Great Almighty, the owner of knowledge and wisdom for His showers of blessings to complete this innovation successfully.

References

- Choo, Y. P., Renu, T., Raman, K., Wen, W. J., & Santhanasamy, V. D. S. (2019). *Mathematics Form 4*. Malaysia: Sasbadi Sdn. Bhd.
- Meyer, M. R., Dekker, T., & Querelle, N. (2001). Innovation in Curriculum: Context in Mathematics Curricula. *National Council of Teachers of Mathematics*, 6(9), 522-527.
- Fioravera, M., & Barana, A. (2017). *Teacher training: a model for introducing innovative digital methodologies for learning Mathematics*. Retrieved from https://www.academia.edu/35812160/Teacher_training_a_model_for_introducing_innovative_digital_methodologies_for_learning_Mathematics
- Mandinach, E. B., & Cline, H. F. (1992). *The Impact of Technological Curriculum Innovation on Teaching and Learning Activities*. Retrieved from <https://files.eric.ed.gov/fulltext/ED345717.pdf>
- Bernama. (December 31, 2016). *New KSSM, KSSR curriculum to be implemented in 2017*. Retrieved from <https://www.malaymail.com/news/malaysia/2016/12/31/new-kssm- kssr-curriculum-to-be-implemented-in-2017-says-education-minister/1283505>

PERMUTATION AND COMBINATION USING VELEA OFF (INTERACTIVE LEARNING OFFLINE)

Siti Nabila binti Sulaiman

Postgraduate Diploma in Education, University of Malaya, Kuala Lumpur, Malaysia
sitinabilasulaiman@gmail.com

Siti Nur Shafila binti Che Kamaruzaman¹, Wan Nurshairah binti Wan Mohammad Nizam¹, Nadiyah binti Mohd Yusuff¹, Hutkemri Zulnaidi²

¹Postgraduate Diploma in Education, University of Malaya, Kuala Lumpur, Malaysia

²Department of Mathematics and Science Education, Faculty of Education, University of Malaya, Malaysia
nur.shafila26@gmail.com, shairah.nizam@yahoo.com, nadiyahmyusuff@gmail.com, hutkemri@um.edu.my

Highlights: VeLeaOff stands for Interactive Learning Offline. We have innovated interactive learning to be offline which is no internet connection required and the student still able to learn at home even though having an issue with the internet. This innovation idea came when some issues regarding online teaching and learning during Movement Control Order (MCO) were due to the Pandemic Covid-19. All schools and institutions closed during MCO and learning continue at home. Teachers will compile all sources of learning in USB pendrive and provide to the student and we able to reduce the number of pupils missing lesson during MCO.

Key words: internet issues, interactive learning, mathematics, offline, teaching and learning

Introduction

Learning and teaching from home (PdPR) has been implemented since the Movement Control Order (MCO) announcement due to Pandemic Covid-19 and schools have been closed during MCO. Teacher is one of the main characters who have to think and be creative about how to teach their pupils during MCO. When the teacher and pupils are at their home, the best way of teaching and learning is online, and every individual needs at least one device with an internet connection to continue teaching and learning sessions. How about some pupils having an internet issue such as a home area that has poor or out of internet coverage or they cannot afford to subscribe to the internet? We have to care for them to prevent them from missing their lessons and this may affect their future. According to former education minister of Malaysia, Dr. Maszlee Malik, the gulf between the haves and have-nots has only widened when learning requires technological resources, leaving those who are not only in Standard 1 and 2, but also Standard 4 to 6 still not mastering the essential skills of writing, reading, and counting. "All of this happened because of the pandemic and because of the loss of schooling hours that they have gone through since last year," said Maszlee. (Dzulkifly, 2021). We are unable to ignore them because they are an asset to the future nation and we believe among them has a very high potential. If we read newspapers since recently, various news regarding online learning challenges such as Internet Access is Weak, Pupils Have to 'Skip' PdPR (Kamarudin, 2021), Father Traveling 5 KM Looking for Internet Coverage for Children Studying PdPR (Ahmad, 2021), 3 Pupils Looking for Internet Access 'Online' Class Fell Off The Bridge (Mikail, 2020) and others news about challenging of the online class. From the news, we know that parents and pupils are struggling with online learning as they know that knowledge is very important about the future.

Content

In this innovation, we try to solve the problem so that the pupils with internet problems can learn like other pupils who can learn online during MCO. However, we only focus on one of the topics in Mathematics, which is Permutation and Combination while this innovation can apply to other subjects or topics. Teachers will compile sources of learning such as notes, learning videos, quizzes, exercises, examinations past years, and others on the USB drive and give to the pupils that have issues with internet connection and access to the device such as smartphone or laptop to continue learning at home without internet access. The innovation will be interactive learning if pupils access USB drives either in personal computers, laptops or netbooks whereas it comes with music and animations or in other words, it seems like games to attract pupils to learn at home as we know kids nowadays are attracted to play games in any devices.



Figure 1. Veleaoff Content Design

Normally, when we heard interactive learning that is related to internet connection but we have innovated it becomes offline and makes it interactive learning. We build it from Microsoft Office PowerPoint that contains sources of learning such as Notes, Videos of Learning, Quizzes, Exercises, Past Years Examination, Exploration about Permutation and Combination, Installers related with Mathematics tools and Mathematics textbooks. We compile all sources learning about Permutation and Combination in one file that the teacher needs to transfer the file to the student's USB drive. Pupils able to access the learning sources in the device without an internet connection and it is one of the advantages of this innovation. Besides, it is environmental friendly due to paper less. The purpose of interactive is actually to encourage pupils to learn at home. Before this, one alternative of PdPR is a teacher will provide hard copy modules for pupils and pupils need to read and try to understand on their own. As we know, one of the processes of learning is a teacher will guide the student but how pupils can learn on their own? To be the innovation is interactive learning, we build VeleaOff seems like games as we know pupils attract with games. It comes with music, colorful background, and static or movement animations. We also provide Videos of Learning about Permutation and Combinations for the student at least they watch something to learn not only reading.

Table 1: Comparisons Before and After Pupils Were Introduced with Veleaoff

Before		After	
How Effective has PdPR Distance Learning Been for You?		Rate How Well You were Engaged during this Lesson.	
Rate	Percentage(%)	Rate	Percentage(%)
1	19	1	0
2	19	2	0
3	33.3	3	20
4	28.6	4	20
5	0	5	60

With this innovation, pupils able to continue learning at home during MCO without an internet connection, and we able to reduce the 'lost generation' issue as raised by the former Malaysian minister of education. PdPR needs support from teachers, pupils, and parents as well. The teacher will provide all sources of learning for pupils, pupils will learn from the sources from teachers and parents will monitor and make sure their children learn at home. However, student needs to provide USB drive and the price is affordable and requires a device at least smartphone as well for this innovation. We believe government and non-government organizations support government efforts in education to provide devices such as smartphones, tablets, or laptops to pupils who cannot afford the device.

References

- Musa, Z., Kiong, W.M., Kamar, A., Ismail, Z., Ahmad Zaki, N., Burham@Borhan, Z.H., Ahmad, S. (2020). *Additional Mathematics Form 5* (Wong, M.K., Trans. Siti Aida, M., Izyani, I. Ed.). Abadi Ilmu Sdn. Bhd.
- Dzulkiily, D. (2021, January 30). How former education minister Maszlee is making sure 'lost generation' of students don't drop out. *Malay Mail*. <https://www.malaymail.com/news/malaysia/2021/01/30/how-former-education-minister-maszlee-is-making-sure-lost-generation-of-stu/1945281>
- Mikail. Y. (2020, November 26). 3 Pupils Looking for Internet Access 'Online' Class Fell Off the Bridge. *BH Online*. <https://origin.bharian.com.my/berita/nasional/2020/11/758832/3-pelajar-cari-akses-internet-kelas-online-jatuh-jambatan>
- Ahmad, A.A., (2021, May 20). Fathers Traveling 5 KM Looking for Internet Coverage for Children Studying PdPR. *Utusan Malaysia*. <https://www.utusan.com.my/terkini/2021/05/bapa-kembara-5-km-cari-liputan-internet-untuk-anak-belajar-pdpr/>
- Kamarudin, H.L., (2021, June 28). Internet Access is Weak, Pupils Have to 'Skip' PdPR. *Sinar Harian*. <https://www.sinarharian.com.my/article/146821/EDIS/Capaian-internet-lemah-pelajar-terpaksa-ponteng-PdPR>

OPTIMISING EBOOK TO OVERCOME STUDENTS' ONLINE LEARNING CHALLENGES

Wan Yusoff Wan Shaharuddin

Faculty of Language Studies and Human Development, Universiti Malaysia Kelantan, Kelantan, Malaysia
yusoff.ws@umk.edu.my

Ruzaini Ijon, Yasmin See, Mohammad Affiq Kamarul Azlan, Mohd Asyraf Zulkfli, Nur Syahirah Mohd Nawi, Noraini Hj. Zaini, Julia Tan Yin Yin

Faculty of Language Studies and Human Development, Universiti Malaysia Kelantan, Kelantan, Malaysia
ruzaini@umk.edu.my, see@outlook.my, affiq.ka@umk.edu.my, asyraf.z@umk.edu.my, syahirah.mn@umk.edu.my,
noraini.zaini@umk.edu.my, julia@umk.edu.my

Highlights: The impact of the COVID-19 pandemic has been one of the major concerns not only to health but also towards education. Students are experiencing a drastic change in learning whereby physical interaction is replaced with virtual interaction. The sudden change in the learning environment has caused the full implementation of online learning, and students are forced to be away from their learning institutions. Consequently, online learning has intensified the occurrence of digital divide during the pandemic. This study aims to examine how the use of ebooks (electronic books) and their optimisation can overcome these problems in the current learning environment.

Keywords: COVID-19 pandemic, education, online learning, digital divide, ebooks

Introduction

The COVID-19 pandemic has had a substantial impact on education and research in universities throughout the world. In order to avoid the spread of COVID-19 infection among the locals, many countries have to take precautionary measures by closing the academic institutions. Since many institutional libraries have been closed, students are obliged to use electronic materials such as ebooks from their respective university libraries when seeking academic information. Recent research conducted in a national university in Japan reveals an increasing number of access to ebooks during the pandemic period (Kodama et al., 2021). In Malaysia, ebooks are not commonly used and popular as most reference books are available in libraries in the form of printed versions or so-called 'hardcopies'. Although there are some publishers who did provide the PDF (portable document format) version of their books, they are still considered as not interactive enough, especially in catering to the need of courses or subjects that requires simulation or demonstration of activities. Therefore, it is suggested that ebooks could be one of the alternative ways to replace the existing printed books, particularly during this time of crisis.

Problem Statement

The closure of most educational institutions as a result of COVID-19 outbreak has changed the conventional teaching and learning style from face-to-face to online mode. The drastic change in the teaching and learning mode has caused many to be unprepared. Some common challenges in the aspect of education include the digital divide, uncertainty regarding student's participation in the online activities, and the increase in effort of the teachers to make the rapid transition to a new online mode of teaching and learning (Majumdar et al., 2020). The main concern during this hard time is that fully online learning has caused deprivation in student's learning qualities in which mostly prompted by digital divide. Poor network connectivity, power cuts, broadband issue, poor audio and video quality, problems with the app, getting disconnected in between the classes and finding it hard to log in again are among of the implications of online learning during the pandemic (Nambiar, 2020). Therefore, it is essential to introduce ebooks in teaching and learning as an alternative way to cope with the issues of internet and data usage problems especially during this pandemic period where many people have been impacted economically. Ebooks can be used offline and less data usage are required to download ebooks into digital devices.

Ebooks

Ebooks can be described as "the electronic version of printed books which can be read on a personal computer or a handheld device designed specifically for the purpose" (Anuradha & Usha, 2006; Öztürk, 2021). Some special features that distinguish ebooks from the PDF version of books are the addition of multimedia features such as pictures, animation, sound, music and video which can be viewed on any electronic devices such as laptop or desktop computers, as well as other portable gadgets (Öztürk, 2021). One example of an ebook that contains all features coined by Öztürk (2021) is 21st Century Communication: Listening Speaking and Critical Thinking by Lynn Bonesteel. This book is currently utilised by the instructors of Intensive Communication Skills in Universiti Malaysia Kelantan (UMK). Figure 1 shows some of the features offered by the ebook:

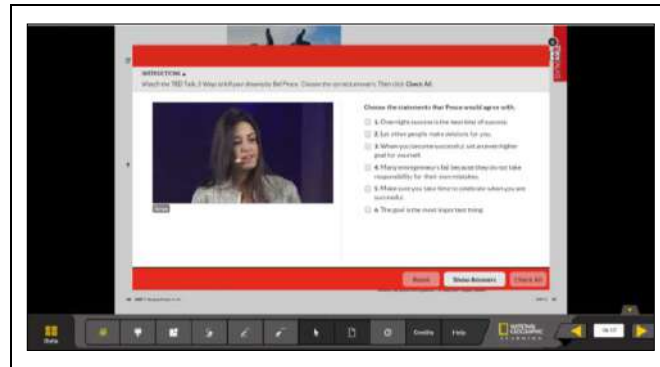

Figure 1: Example of the ebook interface utilised by instructors in UMK

Based on the sample of ebooks displayed in Figure 1, the interface of this version (before the quiz section appeared) is of the same interface shown in the actual physical book. However, it transferred into an ebook with the extensions of pictures, audio and video and interactive quizzes, without even having to be connected to the internet. Such wonders work with the help of a full package of materials such as audio, video and the ebook application that need to be copied and saved in the device that users are using. In the case of this sample, a laptop or desktop computer is much preferable as users can save the folder containing the application and the materials provided by the publisher in the hard drive and it can be opened at any desirable time. In teaching Intensive Communication Skills course, students will be exposed with pronunciation and the utilisation of tones in their speech. The sample ebook is very helpful throughout the process due to its ability to display videos, play audio and help students to practice their speech through imitation and self-reflection, without even having to go online. Nevertheless, not many subjects generally have their own ebook or got an electronic version of the book that they have been using before the pandemic struck. Such situation has cause instructors to rely on students not only to get physical book, but also to search online for supplementary materials such as videos, audio and exercises, which can be in a way deviating from their subjects. By having the same content integrated with interactive features, ebooks could help in facing the challenges of online learning. Other than that, by slowly introducing and encouraging local publishers to produce ebooks, it means more trees on earth will be saved. Thus, producing ebooks will reduce the usage of papers in the manufacturing process.

Confronting Digital Divide using Ebooks in the Era of COVID-19 Pandemic

Prior to the strike of COVID-19 outbreak, digital divide is commonly referring to a sharp divide between two distinct groups in terms of physical access to technology (Azubuike et al., 2021). However, the term digital divide also broadly refers to the "inequalities of internet access" (Büchi, 2017). Recently, the outbreak of COVID-19 pandemic has intensified the occurrence of digital divide particularly towards education. Students who live in rural area and those with low socioeconomic background often faced bad experience in online learning. Thus, it has enforced educators to come out with various teaching styles to overcome these challenges.

Meanwhile, some approaches have been taken to deliver better solution towards online learning challenges such as providing free internet data and digital devices for low income students. Yet, the approaches seem to be inadequate as the pandemic has been striking for over a long time of period. Thus, by enhancing the utilisation of ebooks in teaching and learning, it perhaps offers a solution towards online learning challenges. In addition, distributing ebooks will not require high bandwidth as compared to the conventional materials such as videos and website links (Majumdar et al., 2020). As ebooks can be used offline, it will not only benefit those who have financial problem regarding online learning (eg. insufficient internet facilities at home), but it will also help them to sustain in the long run.

Acknowledgement

The authors would like to express their gratitude towards Universiti Malaysia Kelantan for supporting this study under UMK Fundamental (UMK-FUND) (R/FUND/A0400/01173A/002/2020/00833).

References

- Anuradha, K. T., & Usha, H. S. (2006). Use of e-books in an academic and research environment: A case study from the Indian institute of science. *Program: Electronic Library and Information Systems*, 40(1), 48–62.
- Azubuike, O. B., Adegboye, O., & Quadri, H. (2021). Who Gets to Learn in a Pandemic? Exploring the Digital Divide in Remote Learning During the COVID-19 Pandemic in Nigeria, *International Journal of Educational Research Open*, Vol. 2–2. <https://doi.org/10.1016/j.ijedro.2020.100022>.
- Büchi, M. (2017). Digital Inequalities: Differentiated Internet Use and Social Implications (Doctoral Dissertation University of Zurich https://www.zora.uzh.ch/id/eprint/148989/1/Buchi_2017_DigitalInequalities.pdf
- Kodama, M., Ishita, E., Watanabe, Y., & Tomiura, Y. (2021). Usage of E-books During the COVID-19 Pandemic: A Case Study of Kyushu University Library, Japan. In: Toeppe K., Yan H., Chu S.K.W. (eds) Diversity, Divergence, Dialogue. iConference 2021. Lecture Notes in Computer Science, vol 12646. Springer, Cham. https://doi.org/10.1007/978-3-030-71305-8_40
- Majumdar, R., Chen, M. -. A., Flanagan, B., & Ogata, H. (2020). E-book based learning in times of pandemic. Paper presented at the ICCE 2020 - 28th International Conference on Computers in Education, Proceedings Vol. 1: 680-682.
- Nambiar, D. (2020). The Impact of Online Learning During COVID-19: Students' and Teachers' Perspective. *The International Journal of Indian Psychology*. Vol. 8 (2): 783-793.
- Öztürk, B.K. (2021). Digital reading and the concept of ebook: Metaphorical and analysis of preservice teachers' perceptions regarding the concept of ebook. *SAGE Open*. Vol. 11: 1-12.

TMCAS MODEL: REIMAGING AN IMPACTFUL VIRTUAL COLLABORATIVE PROJECT BASED LEARNING IN TEACHING ENTREPRENEURSHIP

Fadhilhanim Aryani bt Abdullah

Universiti Malaysia Kelantan
aryani.a@umk.edu.my

Noor Raihani Binti Zainol, Nur Farihin Binti Abd Hadi Khan, Muhamad Nasyat Muhamad Nasir,

Aikal Liyani Binti Mohd Rasdi

Universiti Malaysia Kelantan

raihani@umk.edu.my, farihin.ah@umk.edu.my, nasyat.mn@umk.edu.my, lyiani.r@umk.edu.my

Highlights: TMCAS model of Virtual Collaborative Project-Based Learning is the collaboration of student-groups on projects across the places. In this environment, students develop their higher-order thinking skills while solving real-life problems; and lecturers increase their knowledge during mentor-mentee collaborations. Given that TMCAS model is an evolving teaching strategy for entrepreneurship subject. Modern online teaching tools are using to support this environment. This model involved 5 phases, which are Teaching, Mentoring, Coaching, Assessment And Showcase. Students are encouraging to enhance their innovative skill and entrepreneurship skill via conducting an innovation project. Students noted that the model can be used to build projects in groups collaboration without having to physically move from their place. This model allows students to teach and learn from one another; similarly, teachers act as both resource persons and learners while engaging in professional development. Constructive Learning Theory and Design thinking skills were implemented in this model.

Key words: *project based learning, entrepreneurship, TMCAS, modelling teaching*

Introduction

The idea of infusing entrepreneurship into education has spurred much enthusiasm in the last few decades. A myriad of effects has been stated to result from this, such as economic growth, job creation and increased societal resilience, but also individual growth, increased school engagement and improved equality. Putting this idea into practice has however posed significant challenges alongside the stated positive effects. Lack of time and resources, teachers' fear of commercialism, impeding educational structures, assessment difficulties and lack of definitional clarity are some of the challenges practitioners have encountered when trying to infuse entrepreneurship into education. Narrow definition of entrepreneurship viewed as starting a business. Others mean that it is not at all about starting new organizations, but that it instead is about making students more creative, opportunity oriented, proactive and innovative, adhering to a wide definition of entrepreneurship relevant to all walks in life. Entrepreneurship education has traditionally focused on teaching individuals, but many initiatives are increasingly becoming more action-oriented, emphasizing learning by doing. Project based learning seems to be one of the powerful approaches in teaching entrepreneurship. Due to unprecedented events like movement control order (MCO) due to pandemic Covid 19, lecturers need to emphasize and enhance their teaching creativity in order to make sure all the students are still in good learning adaptation regardless of their multiple intelligences.

Content

Project-based learning (PBL) is a student-centered pedagogy that involves a dynamic classroom approach in which it is believed that students acquire a deeper knowledge through active exploration of real-world challenges and problems. Students learn about a subject by working for an extended period of time to investigate and respond to a complex question, challenge, or problem. It is a style of active learning. Project Based Learning is a teaching method in which students gain knowledge and skills by working for an extended period of time to investigate and respond to an authentic, engaging, and complex question, problem, or challenge. The process that was involved is a design thinking process.

This TMCAS model implements a design thinking process that examines the effect of entrepreneurship skill sets on project performance via Virtual Collaborative Project-Based Learning which involves the collaboration of student-groups on projects across the places during Malaysia control Order (MCO). The virtual collaborative PBL is known as BIE (beginners Innovation exhibition and entrepreneurship) project. It is project-based which involves 5 meaningful phases representing the TMCAS model. This phase involved are Teaching, Mentoring, Coaching, Assessment And Showcase. Modern online teaching tools are used to support this environment such as google meet, personal website, youtube channel, fb live and telegram group. Tentatively, few activities and assessment is planned throughout the process of learning. Figure 1 shows the implementation of the design thinking process that was concluded in the TMCAS model.

Figure 1: TMCAS model



There are 9 steps of process design thinking that were shortened and included in the TMCAS model that can give more meaningful learning to the student. PBL relies on learning groups. Student groups determine their projects, and in so doing, they engage student voice by encouraging students to take full responsibility for their learning. This is what makes PBL constructivist. Students work together to accomplish specific goals. When students use technology as a tool to communicate with others, they take on an active role vs. a passive role of transmitting the information by a teacher, a book, or broadcast. The student is constantly making choices on how to obtain, display, or manipulate information. Technology makes it possible for students to think actively about the choices they make and execute. Every student has the opportunity to get involved, either individually or as a group. Project based learning is more about capturing the learning process rather than the final product outcome. That's a really important principle. Some students are struggling finishing the project but their growth of thinking are clearly evidence through the process. Table 1 shows the prototype outline.

Table 1: Prototype Outline

PROTOTYPE OUTLINE

week	Topic	Activities	Assessments
Week 1	Introduction	Lecture / ice breaking / Industry sharing	Reflections
Week 2 - 3	Identification and definition of the problem	Problem tree / Empathy Map / Field trip	Problem tree/ Empathy Map
Week 4 - 5	Idea generation	Brainstorming / Inside statement	Reflections
Week 6 -13	Prototyping and testing (ongoing assessment)	Prototype / Digest, response, and refine / Field trip / active facilitation	Reflections
Week 7	Opportunity Evaluation	Assessment / BMA	Reflections
Week 8 – 10	Market Analysis and Impact Measurement	Simulation / Market survey / Monitoring / Volunteering project	Reflections
Week 11 - 13	Customer value proposition Storytelling for impact	Business model canvas / storytelling	BMC
Week 14	Demo Day	Pitching Exhibition and assessment	Final pitch

The role of lecturer in this kind of approach is as facilitator (mentor and coach). The facilitator must regulate student success with intermittent, transitional goals to ensure student projects remain focused and students have a deep understanding of the concepts being investigated. The students are held accountable to these goals through ongoing feedback and assessments. The ongoing assessment and feedback are essential to ensure the student stays within the scope of the driving question and the core standards the project is trying to unpack. This model was used in 2 entrepreneurship subjects and it enhanced the students' attractiveness in learning entrepreneurship. They are creating the product based on the values that can enhance community wellbeing and they are showcasing it during the exhibition and encouraging to commercialise it. The collaboration with MAGIC and GERIC as industry partners shows that project based learning is a powerful approach in teaching entrepreneurship.

Acknowledgement

We would like to express our sincere gratitude to our students, for wonderfully inspiring us with this great idea and the endless cooperation throughout completing this project. We appreciate and are truly grateful to have the opportunity to be part of this project.

References

- Walcott, P.A. & Rolle-Greenidge, G. (2021). A Cross-Classroom Collaborative Project-Based Learning Management System. In T. Bastiaens (Ed.), *Proceedings of EdMedia + Innovate Learning* (pp. 33-38). United States: Association for the Advancement of Computing in Education (AACE). Retrieved July 30, 2021 from <https://www.learntechlib.org/primary/p/219636/>.
- Breznitz, S. M., Zhang, Q. (2019). Determinants of graduates' entrepreneurial activity. *Small Business Economics*, 55, 1–18.
- Caliendo, M., Goethner, M., Weißenberger, M. (2020). Entrepreneurial persistence beyond survival: Measurement and determinants. *Journal of Small Business Management*, 58(3), 617–647.
- Do, B.-R., Dadvari, A. (2017). The influence of the dark triad on the relationship between entrepreneurial attitude orientation and entrepreneurial intention: A study among students in Taiwan University. *Asia Pacific Management Review*, 22(4), 185–191.
- Karimi, S. (2020). The role of entrepreneurial passion in the formation of students' entrepreneurial intentions. *Applied Economics*, 52(3), 331–344.

CHATBOT: I'M NOT PERFECT BUT I'M HERE TO HELP

Wan Suzanna Aafanii Adeeba Wan Ibrahim

UMK, Malaysia

suzanna@umk.edu.my

Nur Hafezah Hussein, Siti Bahirah Saidi, Ariezal Afzan Hassan & Amaal Fadhlini Mohamed

UMK, Malaysia

nhafezah@umk.edu.my, bahirah@umk.edu.my, ariezal@umk.edu.my, fadhlini@umk.edu.my.

Highlights: The COVID-19 pandemic is unprecedented, and it has changed the way we are living and working. In the educational field, the pandemic has disrupted the regular order of educational settings, and educational organizations must find new settings to maintain an effective teaching and learning environment. It is worth noting that speaking in English is often highlighted as the most anxiety provoking skill in literature (Miskam, N & Saidalvi, A, 2019). Before the pandemic, English as a second language learners (L2) were able to engage in an English conversation during face-to-face lessons with peers and teachers. They were able to ask questions, get instant feedback and eventually enhance their willingness to communicate. Thus, in general, this paper aims to provide teachers with practical strategy for enhancing L2's willingness to communicate and as well as reducing their language speaking anxiety through the Artificial Intelligence chatbot intervention.

Key words: *chatbots, educational technology, ESL, willingness to communicate and confidence*

Introduction

Speaking-related anxiety be it face-to-face or on social media platform are common among English as second language learners (L2). The ability to speak or chat in English effortlessly in a variety of situations have become the greatest fear among L2. Thus, L2 would avoid from asking questions for clarifications or giving responses whenever they were asked in English. Increasing their willingness to communicate can enhance their overall learning experience and confidence. Although there are many advantages of online educational tools to facilitate e-learning, but there are still some drawbacks that may affect L2's willingness to communicate. Learning online during the pandemic led to social isolation due to lack of human communication (Tamm, 2020) and thus it decreases the L2's willingness to communicate.

Content

The purpose of this study is to examine L2 students' willingness to communicate in English and the effectiveness of this chatbot intervention in increasing their willingness to communicate in English. 103 CEFR B1 level undergraduate students participated in the present study. These L2 students undertook English classes via online platform during the COVID-19 pandemic.

Aiming to investigate the efficacy of using Artificial Intelligence (AI) chatbot for enhancing the learners' confidence and willingness to communicate, a pre-intervention and post-intervention studies were conducted among the ESL learners in one of the public universities on the East Coast of Peninsular Malaysia. In a period of one semester, L2 were asked to engage in a conversation with a chatbot regularly. Learners can ask questions and the chosen chatbot app will respond by mimicking the common chat responses similar to a native speaker of English. Learning indirectly with chatbot is potentially very useful for learners as it provides a non-threatening environment for learners to practise and not being afraid of making mistakes. Learning process can occur anywhere and at any time. The measures ranged from surveys on willingness to communicate, attitudes on chatbot and open-ended common expressions to test their English chatting ability before and after the intervention. 89% of L2 responded with variety responses on greeting question in post-test as compared to 77% of L2 gave a generic answer that is far mimicking the native speaker of English. As for L2 perceptions towards learning English through chatbot, 72% of L2 expressed their confidence and contentment chatting in English after practising with chatbot. Additionally, 85.4% of L2 agreed that chatbot is effective in improving their speaking skill.

Although there are some limitations of the AI chatbot which can never replace a real person in communicating within the context, the findings revealed that AI chatbot is efficacious in enhancing the L2 willingness to communicate and confidence in chatting in English. Thus, the use of AI chatbot in second language teaching and learning is advantageous in such a way that it can give students the autonomy in their learning. Language skills especially speaking skill requires a lot of practice. But due to the pandemic, students are having constraint in practicing the language. Therefore, language instructors can use this platform for the students to practice on their own. Further, the use of AI chatbot can help reduce students' anxiety in communicating using English language. Not only it can help them in their willingness to communicate in English, but it provides the students with a space where they can have fun in a non-threatening atmosphere.

In conclusion, this intervention is intended to increase L2 willingness to communicate and decrease their anxiety in speaking in English. With a constant interaction with the chatbot at L2's personal pace, overall language skills especially grammar and writing can also be improved as chatbot provides accurate answers in real time. This study confirmed the L2 improved speaking skill in the post-test.

References

- Miskam, N & Saidalvi, A (2019). Investigating English Language Speaking Anxiety among Malaysian Undergraduate Learners. *Asian Social Science*; Vol. 15, No. 1. Canadian Center of Science and Education.
- Tamm, S. (2020, March 21). 10 Biggest Disadvantages of E-Learning. <https://e-student.org/disadvantages-of-e-learning/#lack-of-communicational-skill-development-in-online-students>.

TEACHING AND LEARNING OF THE PLAN AND ELEVATION USING GOOGLE-WALL APPROACH

Hutkemri Zulnaidi

Department of Mathematics and Science Education, University of Malaya, Kuala Lumpur, Malaysia
hutkemri@um.edu.my

Fatin Farhayu Mohd Salim, Noor Syuryani Lokman,

Nur Asfa Dini Azmi, Nur Hanis Nabilah Saihuddin, Nurul Shafiqah Ismail
Postgraduate Diploma in Education, University of Malaya, Kuala Lumpur, Malaysia
inovasimatematikdiskret@gmail.com

Highlights: Geogle-wall is an innovative approach for teaching and learning of the Plan of Elevation involving three types of medium which are Google Site, Wordwall and Geogebra Software. We use Google Site as a main platform of this innovation followed by Wordwall and Geogebra Software. The Wordwall application is used to assess student's understanding before and after the exploration of the Geogle-Wall. Besides, Geogebra Software is use as the medium of the activities.

Key words: *Fun Learning, Geogebra Software, Google-Site, Interactive Learning, Plan and Elevation, Wordwall*

Introduction

Students face difficulties in visualizing and drawing the plan and elevation of the three-dimensional objects. Currently, teachers use the sponge method as teaching tools due to lack of exposure and skills in using technologies. In this research, we explained how we can achieve an interactive and fun learning environment using the Geogle-Wall approach where it is a combination of Google-Site, Wordwall and Geogebra in order to develop student's interest and understanding. This innovation is also in line with the Malaysian Education Development Plan (PPPM) to utilise Information and Communication Technology (ICT) in order to improve the quality of the learning.

Content

Description of Geogle-Wall

Geogle-wall is an innovative approach for teaching and learning of the Plan of Elevation involving three types of medium which are Google Site, Wordwall and Geogebra Software. We use Google Site as a main platform of this innovation followed by Wordwall and Geogebra Software. Students will be given a Geogle Wall link by the teacher for students to start the exploration. The exploration in Geogle-wall is divided into three levels which are level 1 (easy), level 2 (moderate) and level 3 (difficult). The students will start with level 1 then proceed to the next level until level 3. In each level, students will do a pre-quiz to assess their level of understanding towards the topic. Then, students will continue their exploration using Geogebra activities. There are three Geogebra activities in each level. Next, students will be doing a post- quiz to evaluate the effectiveness of the exploration. After all levels are completed, students will give feedback and their email address using Google Form and the certificates will be auto generated when students submit their form. The illustration of the innovation process as explained in the figure 1 below:

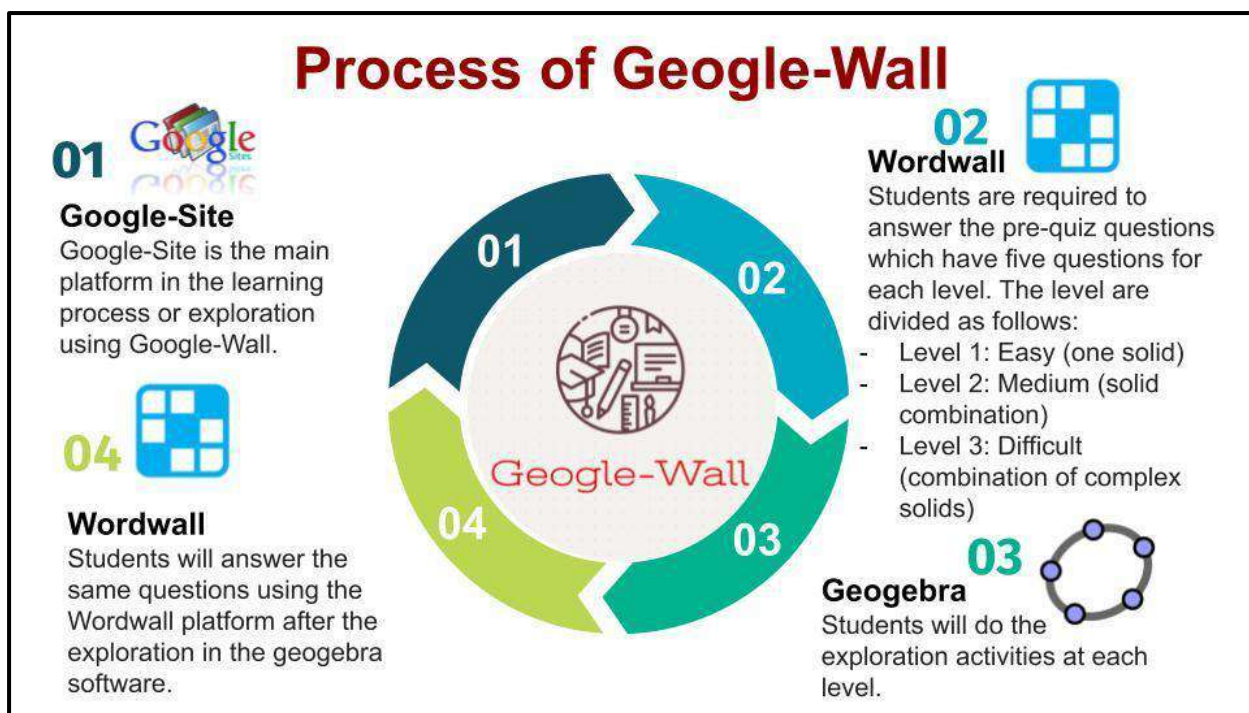

Figure 1: Process of Geogle-Wall

Background of Geogle-Wall

Students face difficulties in visualizing and drawing the plan and elevation of the three-dimensional objects. Currently, teachers use the sponge method as teaching tools due to lack of exposure and skills in using technologies. In this research, we explained how we can achieve an interactive and fun learning environment using the Geogle-Wall approach where it is a combination of Google-Site, Wordwall and Geogebra in order to develop student's interest and understanding. This innovation is also in line with the Malaysian Education Development Plan (PPPM) to utilise Information and Communication Technology (ICT) in order to improve the quality of the learning. From the analysis, most of users score higher at post-quiz which mean that the activities done in this innovation are effective and help users to have more understanding on Plan and Elevation topic.

Table 1: Analysis result for pre-quiz and post-quiz of Geogle-Wall for each level.

No	Student	Level 1		Level 2		Level 3	
		Pre-Quiz	Post-Quiz	Pre-Quiz	Post-Quiz	Pre-Quiz	Post-Quiz
1	Student 1	3	5	4	5	4	5
2	Student 2	4	5	4	4	3	5
3	Student 3	5	5	5	5	4	4
4	Student 4	5	5	5	5	4	4
5	Student 5	3	4	5	5	4	4
6	Student 6	4	4	3	5	4	4
7	Student 7	5	5	4	5	4	5
8	Student 8	4	5	4	5	3	5
9	Student 9	5	5	5	5	5	5
10	Student 10	4	5	4	4	2	4

The importance of Geogle-Wall to education

This innovation is important to education because it can be used as one of the teaching tools in physical or online classes. The activities in Geogebra are arranged according to the Van Hiele Model of geometric thinking. This innovation can help to develop students' geometric thinking abilities. Each level has its own description of how students think about geometrical objects. The progress from one level to the next level is more dependent upon instructions. Next, students can have hands-on experience and visualise the three-dimensional objects using technologies rather than static pictures or objects in the textbooks.

Advantages of Geogle-Wall towards education and community

The Geogle-Wall can be accessed by anyone with the link. This platform is a great kick start to give exposure toward the technologies for the community especially teachers, students and parents. This platform is also easy to be accessed everywhere including school, office and home. In terms of the students' progress in their education, students will be able to use this platform without time limitation in doing their exploration. We also include real-life and culture related examples to increase student awareness about the relation of the topic to their real-life situation and culture in Malaysia. Another advantage of our innovation is it has been tested by a teacher and students. The result shows that the approach is effective for students learning the Plan and Elevation.

Commercial value in terms of marketability or profitability of the Geogle-Wall

Geogle-Wall has commercial value in both marketability and profitability because the innovations are restricted to anyone with the link. We can open the market of innovation to the community including teachers, students and parents. Therefore, they have to pay a certain amount in order to purchase the link.

Acknowledgement

We are grateful and thanks to Puan Siti Nor Binti Haji Sulaiman for sharing her experience as a senior mathematics teacher. We also want to thank all students involved in implementing this innovation.

References

- Adulyasas, L. (2020). Transferring Van Hiele Phase based Earning to the Tablet Application for Enhancing Secondary Student's Geometric Thinking. *Journal of Advanced Research in Dynamical and Control Systems*, 12(SP4), 8–15. <https://doi.org/10.5373/jardcs/v12sp4/20201460>
- Mwingirwa, I.M. & Miheso-O'Connor, M.K. (2016). Status of teachers' technology uptake and use of GeoGebra in teaching secondary school mathematics in Kenya. *International Journal of Research in Education and Science (IJRES)*, 2(2), 286-294.

DEVELOPING WEBSITE FOR MANAGING STUDENT IN ENTERPRISE PROGRAM (SIEP) IN FACULTY OF ARCHITECTURE AND EKISTICS

Nuzul Haqimi Muhammad

Universiti Malaysia Kelantan, Bachok, Kelantan, Malaysia
nuzulhaqimi@umk.edu.my

**Azlin Sharina Abdul Latif, Ismi Luqman Hamadi Bin Ibrahim, Nurul Izzati Binti Othmani, Muhammad Rizal
Bin Khairuddin**

Universiti Malaysia Kelantan, Bachok, Kelantan, Malaysia
azlinsharina@umk.edu.my, hamadi.i@umk.edu.my, izzati.o@umk.edu.my, rizal.k@umk.edu.my

Highlights: The following study will explore the development of a website that was used to manage data and delegate student work for grading due to the large volume of submissions. The websites that have been developed allow lecturers to effectively manage student progress and submissions in a central place so that they can track their student's progress, especially during the pandemic.

Keywords: *web application in education, online learning, website development, teaching materials, database in teaching and learning*

Introduction

During the Covid-19 epidemic, online learning has become the primary method of instruction. Lecturers are compelled to create content and communicate with students in their classes using web-based technology. In many university courses, tools such as the Learning Management System (LMS) and various authoring tools are heavily utilised to organise and plan teaching and learning activities (Abdulrahman et al., 2020). This research will look at how websites and web-based technologies may be used to improve the experience of teaching and learning in the setting of a comprehensive course that includes virtually all of a faculty's students. We take into account the system's design and any other factors that must be taken into account to fulfil the objectives and goals of teaching and learning activities (Cook & Dupras, 2004). We also discussed the many web tools that may be utilised and how they can be integrated with the website that has been built. The findings from the website's usability would help us to learn about the methodology's limitations, opportunities, and potential for managing students' activities throughout the Student in Enterprise Program course. The implications are reviewed and the feasibility of such initiatives in improving student and lecturer engagement while navigating such a challenging course.

Content

1. Description

By providing students and lecturers with a one-stop platform, the websites built would allow lecturers to monitor student activities and progress submissions through specific sites. The website would also make it easier for students and lecturers to share materials, particularly in the form of digital reports and papers (Schindler et al., 2017). All of the activities are recorded in one unified system for easier management. The activities involved are as follows:

- Students need to register for their placement in an enterprise. This registration needs to be approved by lecturers.
- Upon approval, the faculty needs to produce a letter to the company to officially inform the students' intentions and course requirements.
- Students then need to continue their training in their respective companies while maintaining a log.
- When students completed their training, they need to submit reports, logs and evaluations from the companies.
- From the submission, the lecturers need to grade the students' works. All the grades, then, would be processed by the coordinator.

2. Background

The course involves is SGT 4212 Student in Enterprise Program (SIEP). This course requires the coordinator to manage almost all the students and the lecturers in the faculty. Moreover, the course is based on two modules that the student needs to register and complete to get grades.

3. Why Are They Important?

Previously a lot had been done to address the need for a proper dashboard or place for all materials in the online teaching and learning experience. However, the need to manage an extensive amount of materials in this course has provided some insight into how to manage and create a system that can be used in such a situation.

4. Advantages

- Allow faster sharing between students and lecturers.
- Allow faster tracking of student progress
- Unified database for all activities and course needs, giving insights on how all parties can tackle the course.

References

- Abdurahaman, M. D., Faruk, N., Oloyede, A. A., Surajudeen-Bakinde, N. T., Olawoyin, L. A., Mejab, O. V., Imam-Fulani, Y. O., Fahm, A. O., & Azeez, A. L. (2020). Multimedia Tools In The Teaching And Learning Processes: A Systematic Review. *Heliyon*, 6(11), E05312. <https://doi.org/10.1016/j.heliyon.2020.E05312>
- Cook, D. A., & Dupras, D. M. (2004). A Practical Guide To Developing Effective Web-Based Learning. *Journal Of General Internal Medicine*, 19(6), 698–707. <https://doi.org/10.1111/j.1525-1497.2004.30029.x>
- Schindler, L.A., Burkholder, G.J., Morad, O.A. _Et Al._ Computer-Based Technology And Student Engagement: A Critical Review Of The Literature. *Int J Educ Technol High Educ* 14, 25 (2017). <https://doi.org/10.1186/s41239-017-0063-0>

DIGITAL STORYTELLING: A HOLISTIC PROJECT BASED LEARNING TO ENHANCE 21st CENTURY SKILLS

Najihah Mahmud

Universiti Malaysia Kelantan, Bachok, Kelantan
najihah.m@umk.edu.my

Siti Amirah Ahmad Tarmizi, Amaal Fadhlini Mohamed, Ariezal Afzan Hassan

Universiti Malaysia Kelantan, Bachok, Malaysia
amirah@umk.edu.my, fadhlini@umk.edu.my, ariezal@umk.edu.my

Highlights: Being recognized as a powerful technological innovation for the 21st century classroom (Robin 2008), DST has caught many practitioners' attention and they have started to utilize DST to aid in the teaching and learning process. This innovation has been widely used in the western context signified by the various established centres related to DST (Centre for Digital Storytelling, United States; Digistories, United Kingdom; Australian Centre for the Moving Image, Australia) and has started to spread to Asia (Digital Storytelling Asia Pte Ltd, Singapore).

Key words: *digital storytelling, CALL, 21st century skills, PBL, technology, language*

Introduction

Today's advanced economies, innovative industries, and high-growth jobs have increased the demands in the job market for more educated workers with 21st century skills which include the ability to respond flexibly to complex problems, communicate effectively, manage information, work in teams and provide new knowledge (P21, 2011). Current pedagogy needs an agenda that infuses 21st century skills into the teaching and learning to meet the demands of the global economy and a dramatically different society in order for students to develop 21st century competencies. Jakes and Brennan (2006) organized 21st century skills into four categories; digital age literacies, inventive thinking, effective communication, and high productivity.

As far as technology integration in education is concerned, digital storytelling (DST) is one of the pedagogical innovations that could be employed to develop 21st century skills and at the same time, enhance English language learning. The term 'digital story' was coined by Dana Atchley in the 1980's (Robin 2008). Many different definitions were given to define "Digital Storytelling" (McLellan, 2006; Hathorn, 2005), but in general, digital storytelling means combining the arts of storytelling with a variety of digital multimedia, such as images, videos, background music, and voice narration.

Content

DST is seen as an ideal alternative as compared to the conventional tasks given to students such as writing research reports, answering reading comprehension questions or memorizing grammar rules in the language classroom. Unlike the conventional tasks listed, DST can assist students to build up their English language skills, ICT skills, and soft skills (Robin, 2008; Hafner & Miller, 2011) which meet the demands in the job market. Recent evidences suggest that this computer-based multimedia task has helped students to improve their research skills, organizational skills, and give students greater interest in the content being taught (Salpeter, 2005).

It has been suggested that the inclusion of digital technologies "can support a more flexible, learner-centred notion of education that facilitates the soft skills vital for the demands of the 21st century global service and information economy" (Livingstone 2012, p.16).

There were four stages that students had to go through in the DST project as depicted in Figure 1.

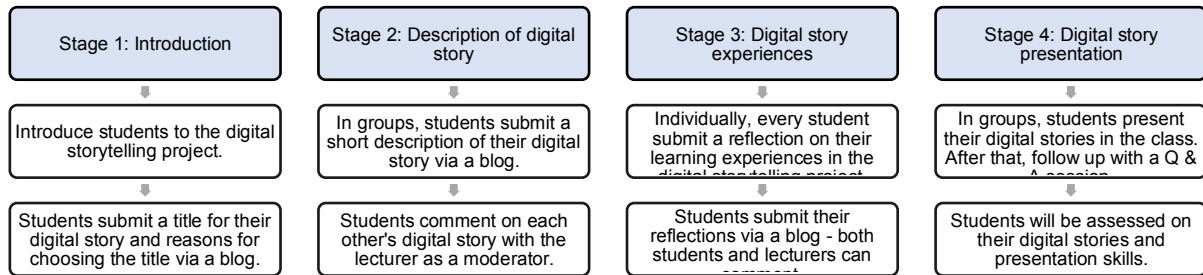

Figure 1 Description of the tasks and assessment involved in the project

The findings suggest that in general, despite the demanding nature of DST, students seemed to be receptive towards the innovation. They had developed their own digital stories in a group with minimal help from the instructors. It had enabled students to exercise their critical thinking skills and expose them to the collaborative working environment. The findings also revealed that the main challenges students faced were related to difficulties in working in group and technical problems such as software incompatibility and slow Internet connectivity.

References

- Hafner, C.A., & Miller, L. (2011). Fostering learner autonomy in English for science: A collaborative digital video project in a technological learning environment. *Language Learning & Technology* 15(3), 68-86.
- Hathorn, P.P. (2005). Using digital storytelling as literacy tool for the inner city middle school youth. *The Charter Schools Resource Journal* 1(1). <http://www.ehhs.cmich.edu/~tcsrj/phathorn.pdf>
- Jakes, D., & Brennan, J. (2006). *Digital Storytelling, visual literacy and 21st century skills*. http://www.techlearning.com/techlearning/pdf/events/techforum/ny05/Vault_article_jakesbrennan.pdf
- Livingstone, S. (2012). Critical reflections on the benefits of ICT in education. *Oxford review of education* 38(1), 9-24.
- McLellan, H. (2006). Digital storytelling in higher education. *Journal of Computing in Higher Education* 19(1), 65-79.
- P21. (2011). *The partnership for 21st century skills: A framework for 21st century learning*. <http://www.p21.org/>
- Robin, B.R. (2008). Digital storytelling: A powerful technology tool for the 21st century classroom. *Theory Into Practice* 47, 220-228.
- Salpeter, J. (2005). Telling tales with technology. *Technology and Learning* 25(7), 18-24.

ADAPTATION OF INTERACTIVE WEB TOOLS 2.0 IN ENTREPRENEURSHIP COURSES

Hazrina Hasbolah

Faculty of Entrepreneurship and Business, Universiti Malaysia Kelantan, 16100 Kota Bharu Kelantan, Malaysia.
hazrina.h@umk.edu.my

Nurul Azwa binti Mohamed Khadri, Dr. Syamsuriana binti Sidek, Dr. Yusrinadini Zahirah binti Md. Isa@Yusuff

Faculty of Entrepreneurship and Business, Universiti Malaysia Kelantan, 16100 Kota Bharu Kelantan, Malaysia.
azwa.mk@umk.edu.my; suriana@umk.edu.my; yusrinadini@umk.edu.my

Highlights: The development of the Information and communication technology has always affected every aspect of human life, as well as education. After decades of development, entrepreneurship education has gained popularity among universities around the world (Wu, Yang, & Chen, 2020). The evolution of technological advancement in education open to an emergent interest in innovative teaching and learning approaches to match with the current 21st century learners (Hsiung, 2018). Reflecting to the Covid-19 Pandemic, the existing of infusing entrepreneurial teaching mode seems ineffectively achieving the entrepreneurship education's objectives of the students' innovative spirit, entrepreneurial quality, and entrepreneurial ability. Due to that, the speed in the facilitation on online education preferably among higher education institutions commenced to increase and it will continually to be online as regard to the Ministry of Higher Education announcement. In fact, it requires for students to be ready with the facilitating condition and a gradual support system to make doubly sure the effectiveness of educational technologies. Precisely, to cope with that, the Web 2.0 tools have been widely used since it provides opportunities for the users to have interaction and engagement with people around the world and open the opportunity for global learning. Thus, this study designed interactive teaching and learning mode to promote the implementation and to support the effectiveness of interactive teaching and learning for students' entrepreneurship courses.

Key words: *Entrepreneurship education, Web tools 2.0*

Introduction

The ulterior focus of the entrepreneurship courses purposely to help the students to understand all the entrepreneurship's relevant concepts, entrepreneurs' real characteristics as well as attributes, and also exposed towards the entrepreneurial activities and spirit from the perspective of real successful entrepreneurs in a way to improve students' entrepreneurial ability, skill and knowledge. Nevertheless, the provision issues of pandemic will give some obstacles towards effective implementation of teaching and learning process (Hassan et al., 2021) as it is a discipline, which require much for students to acquire "learning by doing"—practical competencies and experiences in an authentic setting as well (Liguori & Winkler, 2020; Kassean et al., 2015). The selection of right tools plays the vital part to assist the students not only synthesize their learning, but also engaging intensely on particular contents of assessment and interact each other in more evocative ways than the traditional approach. Hence, to cope with that, the adaptation of Web 2.0 tools such as image and video hosting, social networking sites and any applications to generate Web contents for education have been widely used by developing countries that open great opportunities for interacting and engaging people around the world and, thus, open the opportunity for global learning.



Content

The adaptation of Web 2.0 technology is an end-user application that virtually require a dynamic interaction and collaboration with each other (Bugawa & Mirzal, 2018). It comprises of social networking sites (i.e Facebook, Instagram), blogs, wikis (i.e Wikipedia), video or multimedia sharing (i.e Youtube), and websites utilized for discussion, sharing the educational contents (Hassan, BaraU Gamji, Yahaya Nasidi & Latiff Azmi, 2021) and also synchronized tools that are openly accessible (Al-Samarraie & Saeed, 2018; Wang, Chen, & Khan, 2014).

Generally, the Web 2.0 tools in teaching and learning offered numerous benefits for both educators and learners. Among them are:

i. Multiple means to connect

The adaptation of Web 2.0 tools in entrepreneurship courses opens for the students with no trouble connect with their lecturers via multiple locations in a Web 2.0 environment and also all the technological means at anytime and anywhere. For example, is handling class activities, quizzes, or assessment through the Padlet website. The interface will definitely increase students' autonomy and engagement with contents and create interesting learning.



Example of Padlet Quiz

ii. Perceived Ease to create

In addition, the Web 2.0 tools is easy to create and really user friendly where user can add images, videos or link to other media contents. The best example is learning through the social networking preferably Facebook and Instagram where nowadays almost all students already sign it up. At the same time the social media is internet- based applications and technological foundations of Web 2.0 tools. As reported by Lister (2018), there are approximately 20 million of entrepreneurs around the world actively using the social media as one of major platform to approach customers either through the Facebook live, fb ads or direct advertising. From that students will expose directly on skills possesses by an entrepreneur such as communication skills, negotiations skills, leadership skills, buying and selling skills as well as embedded it in their entrepreneurship activities. The easiness would avoid time wasted in practicing the syllabus learning the courses.

Example of Facebook Live

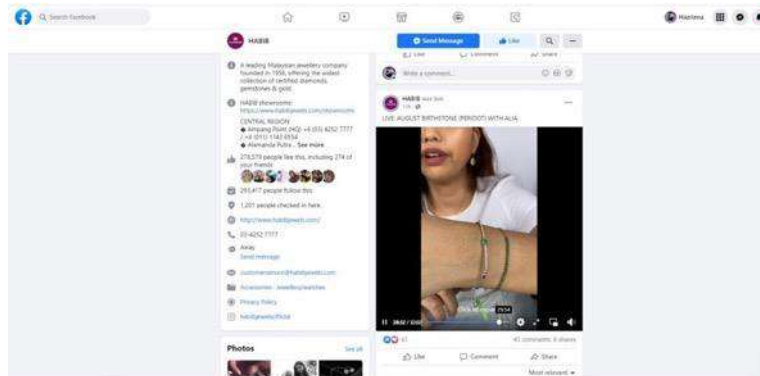

iii. Effectively change the way to communicate

The Web 2.0 tools facilitate interactive learning and innovative responses to assignments and assessments. As by Kompen et al., (2018), the emergence of Web 2.0 tools in higher education changes the way students and educators communicate each other. When the educators assign the tasks, students respond their ideas simultaneously and will be rewarded with a specific result while there has been any error, they can directly interact the right answer in the nick of time, so students tend to gain efficient input during the learning process. This will not only increase students' self-efficacy, but also motivates students to communicate more earnestly, confidently and actively in the content of their responses.

iv. Collaborative Learning

Web 2.0 tools also can facilitate authentic interactions with content and with other learners (Mata et al., 2019). Research shows that the integration of Web 2.0 tools into the traditional learning approach can aid the students to develop collaborative learning (Abdul Rahman et al., 2020). In other words, it offers opportunities for students to solve particular problems in completing the courses and encourage the students to collaborate in meaningful ways with peers especially when they are doing group

assignment. Students will have the freedom to customize their responses using multimedia or multiple modalities which is contrasting to a term paper, or traditional project.

v. Easily to share

Despite of that, the adaptation of Web 2.0 tools in the entrepreneurship courses will easily the educators as well as students to share video link presentation like Powtoon, animation maker, or youtube links regarding all related information to the courses. Then, the links and students' individual interpretations and representations of their specific conceptual understandings will effortlessly share with one to another, thus increasing the learning opportunities for all.



Example of Youtube link

Acknowledgement (if any)

The authors would like to express sincere gratitude to the Universiti Malaysia Kelantan for giving us the golden opportunities to join CRI 2021 as well as our appreciation also goes to Faculty of Entrepreneurship and Business for giving us this opportunity to participate CARNIVAL OF RESEARCH AND INNOVATION (CRI2021) in conjunction with International Virtual Innovation & Invention Challenge (INTELLIGENT2021) & Creative Innovation Carnival (CIC2021). Special gratitudes also goes to all researchers: Ms. Nurul Azwa Mohamed Khadri, Dr. Syamsuriana Sidek and Dr. Yusrinadini Zahirah Md. Isa@Yusuff for their excellent effort granted throughout this project.

References

- Abdul Rahman, A. M. A., Azmi, M. N. L., & Hassan, I. (2020). Improvement of English Writing Skills through Blended Learning among University Students in Malaysia. *Universal Journal of Educational Research*, 8(12A), 7694-7701. doi: 10.13189/ujer.2020.082556
- Al-Samarraie, H., & Saeed, N. (2018). A systematic review of cloud computing tools for collaborative learning: Opportunities and challenges to the blended-learning environment. *Computers & Education*, 124(1), 77-91. doi: 10.1016/j.compedu.2018.05.016
- Bugawa, A. M., & Mirzal, A. (2018). The impact of Web 2.0 technologies on the learning experience of students in higher education: A review. *International Journal of Web-Based Learning and Teaching Technologies (IJWLTT)*, 13(3), 1-17. doi: DOI: 10.4018/IJWLTT.201807010
- García-Morales, V. J., Martín-Rojas, R., & Garde-Sánchez, R. (2020). How to encourage social entrepreneurship action? using web 2.0 technologies in higher education institutions. *Journal of business ethics*, 161(2), 329-350.
- Hassan, I., BaraU Gamji, M., Yahaya Nasidi, Q., & Latiff Azmi, M. N. (2021). Challenges and Benefits of Web 2.0-based Learning among International Students of English during the Covid-19 Pandemic in Cyprus. *Arab World English Journal*.
- Kompen, R. T., Edirisingha, P., Canaleta, X., Alsina, M., & Monguet, J. M. (2019). Personal learning Environments based on Web 2.0 services in higher education. *Telematics and informatics*, 38, 194-206.
- Lister, M. (2018). 40 essential social media marketing statistics for 2018. Retrieved from <https://www.wordstream.com/blog/ws/2017/01/05/social-media-marketingstatistics>.
- Mata, L., Panisoara, G., Fat, S., Panisoara, I. O., & Lazar, I. (2019). Exploring the Adoptions by Students of Web 2.0 Tools for E-Learning in Higher Education: Web 2.0 Tools for E-Learning in Higher Education. In *Advanced Web Applications and Progressing E-Learning 2.0 Technologies in Higher Education* (pp. 128-149). IGI Global.
- Olanrewaju, A. S. T., Hossain, M. A., Whiteside, N., & Mercieca, P. (2020). Social media and entrepreneurship research: A literature review. *International Journal of Information Management*, 50, 90-11.

CATCH ME FOR I - SCIENCE

Hasanah Binti Safein @ Shafie

Politeknik Kota Bharu, Kota Bharu, Malaysia
hasanah@pkb.edu.my

**Muhammad Daniel Nafis Bin Ahmad, Muhammad Yahya Bin Mat Rashid, Wan Mohamad Fikri Bin Wan
Shaharuddin**

Politeknik Kota Bharu, Kota Bharu, Malaysia
modanafis@gmail.com, emberspirit290@gmail.com, wanmhdfikri2391@gmail.com

Highlights: Catch Me for I - Science is developed as one of the alternatives to the Student Centered Learning platform where students can explore an encyclopedia of science engineering at the polytechnic level in a more focused manner. Catch Me For Me - Science. This project was developed with students to help facilitate students to implement mini -projects in engineering science courses in a more focused manner. This innovation also clarifies the basic theories that need to be related to engineering science courses and students can implement mini -projects next mastering and applying in the real world. Apart from that through the Catch Me For I approach - Science is a new innovation instrument in OBE teaching and learning in meeting the millennium to 21. It is also a self -learning material that helps new lecturers to implement engineering science mini projects more focused and deep. The results of the survey of 286 student status visitors showed an increase in interest, understanding and motivation towards engineering science.

Key words: *learning, self, focus, engineering science*

Introduction

The process of teaching and learning (T&L) in formal education should be given due emphasis. The teaching and learning process of the lecture room which involves lecturers and students indeed requires a continuous effort towards providing a comprehensive and effective education on all the contents of the lessons delivered. Therefore, to ensure students' understanding at the maximum level of the R & D process should be given a "touch" that can attract the interest of students.

Yet so recently we were shaken by the news of a novel outbreak of coronavirus (COVID-19) that hit the rest of the world. As a result, many people are affected financially, employment and so on. Students are no exception, they are also affected in terms of education because most institutions do not operate face to face during the Movement Control Order (PKP) to prevent the spread of this pandemic.

herefore, a website with the concept of "One Stop Center" should be created to make it easier for students to make references without having to use a lot of internet quota. This will make it easier for students who want to find reference sources by using a minimum internet quota.

Content

This website was developed using the wordpress.com website. Users can 'access' the login by typing 'www.esciencejmsk.com'. The website contains 12 menu displays such as Home, Project Science, Video Experiment, Notes, Theoretical Exercise, Multimedia Science, Work Example, Quiz and R&D Science Users interact with this site by answering quizzes for self -testing. The Catch Me For i-Science innovation developed is one of the alternatives to the Student Centered Learning platform where students can explore an encyclopedia of science engineering at the polytechnic level in a more focused manner.

This innovation also clarifies the basic theories that need to be related to engineering science courses polytechnics and implements mini -projects in ensuring students and visitors can master and apply in the real world. The objectives are to accelerate and provide understanding to students whether in theory or practice accurately, interestingly and at an immediate rate. Motivate students to learn and deepen engineering science courses and implement mini projects interactively. Encourage students to do drills where various questions are provided in the form of exercises, quizzes, tests and sample questions last semester online by providing questions and sample answers in interactive form using proprofs software. Furthermore, the innovation facilitate and focus the students to explore the content of learning and further enrich the learning process as well as help lecturers to teach online in the event of time constraints that cause the cancellation of classes where teaching can be done online by students. Students can also repeat several times on topics that are less understood and learning becomes more effective according to the ability of students.

In advance preparation before carrying out practicals, lectures and projects by watching multimedia examples and lecture notes in advance on the site Based on the results of the study showed that the majority of students agreed that this learning website can help and have a positive impact on their learning. With this we can conclude that the use of this website is effective in student learning

Through the development of this website can benefit the teaching and learning process of engineering science at the polytechnic level. This innovation is expected to provide equal learning opportunities to all students of various levels of intellectual ability with more interactive and dynamic because in a class not all students have the same ability in accepting something taught by lecturers.

Acknowledgement

We are grateful for Politeknik Kota Bharu to concern and encourage through enhance our in sting innovation

References

- 52 peratus pelajar Sabah tiada akses internet (2020, 8 Mei). Berita Harian Online. Available at: <https://www.bharian.com.my/berita/nasional/2020/05/686499/52-peratus-pelajar-sabah-tiada-akses-internet> (accessed 10 June, 2020). Google Scholar
- Mohd Arif Ismail & Mohd Jasmy Abd Rahman. 2000. Pembinaan laman web untuk pengajaran fokus terhadap kursus GE2123: Teknologi dan inovasi dalam pendidikan. Prosiding Seminar Pendidikan Kebangsaan 2000. Hotel Equatorial Bangi. 14-15 November 2000.
- Wan Mohd Hujjatullah Wan Ghazali. 2001. Pembinaan laman web untuk program Pendidikan Islam, Fakulti Pendidikan UKM. Projek Penyelidikan Ijazah Sarjana Pendidikan: UKM. Zahiah Kassim & Abdul Razaq Ahmad. 2009. E-Pembelajaran: Evolusi internet dalam pembelajaran sepanjang hayat: UKM.
- Mahidun Sardi. 2007. Analisa laman web Pendidikan Islam: Penggunaannya sebagai bahan Bantu mengajar. Laporan Penyelidikan Kajian Bebas. Fakulti Pendidikan: UKM.
- Iberahim, Hasmah (2014) Pengaruh faktor persekitaran terhadap kecemerlangan akademik pelajar Fakulti Kejuruteraan Mekanikal dan Pembuatan serta pelajar Fakulti Kejuruteraan Elektrik di UTHM. Masters thesis, Universiti Tun Hussein Onn Malaysia.
- Campbell, C. S., Lum, J. F., & Singh, N. (2000). SML: You're really learning now. *Syllabus*, 14 (1), 24-26.61.
- Zolkepli Haron, Effandi Zakaria, Zurina Mahadi & Hukil Sino. 2001. Persepsi pelajar PJJ UKM terhadap pembelajaran secara online. Pembentangan Kertas Kerja Konvensyen Persatuan Teknologi Pendidikan Malaysia kali ke 14. Hotel Goldcourse, Kelang. 11-14 September
- Zurina Yasak, Baharom Mohamad, Ahmad Esa & Shahrizal Shabuddin (2009). Kaedah Pengajaran Berasaskan Laman Web Terhadap Pelajar Diploma Kejuruteraan Elektrik Mekatronik Di Politeknik. Keterangan: Persidangan Kebangsaan Pendidikan Sains dan Teknologi 2009, 26-27 Oktober 2009, UTHM
- Rahimi Md. Saad, Zawawi Ismail, Wan Nordin Bin Wan Abdullah (2005). Pengajaran dan Pembelajaran Bahasa Arab Berasaskan Web. Kertas kerja seminar Seminar Penyelidikan Pendidikan Maktab Perguruan Baru Lintang. 15-16 September.

E-LEARNING IN SPANISH LANGUAGE

Mariyati Haji Mohd Nor

Universiti Pendidikan Sultan Idris, Perak, Malaysia
mariyati@pbmpu.upsi.edu.my

Harnani Mat Zin, Harozila Ramli

Universiti Pendidikan Sultan Idris, Perak, Malaysia
harnani@fskik.upsi.edu.my, harozila@fskik.upsi.edu.my

Highlights: Along with the development of Technology, Information and Communication in education world, specifically in language learning, this development give challenges to instructors to develop a teaching and learning platform which can be utilised by students effectively. There are various free online learning websites can be applied by students to learn including the blog. Spanish as Easy as ABC with Doctora Mariyati is a blog developed by lecturer with purpose of helping outside classroom learning via online. E- learning among university students has been one of the effective methods of learning and contributed to more flexsible environment.

Key words: *Spanish, Blog, E-Learning, Teaching, Language, Platform*

Introduction

In Malaysia, other than in-class learning, lecturers also use e-learning as one of the Self Learning Time (SLT) that helps students learn outside of the class. The acceptance of e-learning is not only capable in transforming the traditional teaching and learning, moreover, the usage of technologies in learning gives impacts and more effective and flexsible environment. Overall, the usage of this blog in teaching and learning has given positive impact on student's mastery, increasing the comprehension, adding new vocabularies, improving student's achievement also giving more exciting learning experiences to students in learning Spanish language.

Content

1. Description of innovation / product development / design / process.

This learning blog was developed based on the Spanish language teaching structure syllabus in UPSI. Through this blog also, all topics taught in class are descriptively explained and each topic will include language activities and exercises to be practised by students. Students can interact with lecturer in the comment coloumn of each entry and also with their friends. Student can also access this learning blog using computer, laptop, and smartphone to learn and do the tasks as instructed by lecturer or teacher in the blog. Related writings on Spanish language in this blog can be benifitted by all students as an alternative source other than in-class learning. The learning model was developed based on the syllabus taught in class including learning planning, learning execution, evaluation and assessment which help student to learn Spanish language anywhere. Therefore, this blog is used as a learning media and source that helps student in mastering Spanish language as foreign language among students in Malaysia. The usage of this blog embolden the reading and writing culture of student compared to the traditional methodology. Lecturer can design attractive blog site based on their own ideas through videos, pictures and attract student;s interest to read and answer questions asked in the comment coloumn. Other than that, student also can ask questions and discuss in the comment coloumn and the discussion can be also discussed in class. Lecturer also provides opportunity for student to write and realise their imagination through the blog usage. This blog has been fully utilised to the level 1 Spanish language students in UPSI beginning on semester II 2019/2020 session and students can benifitted the teaching and learning in this blog. This blog has been proven to improve students' understanding and mastery based on the grade improvement obtained after using this blog starting in semester 2 2019/2020. The link for each topic has been added in the students text book using QR code.

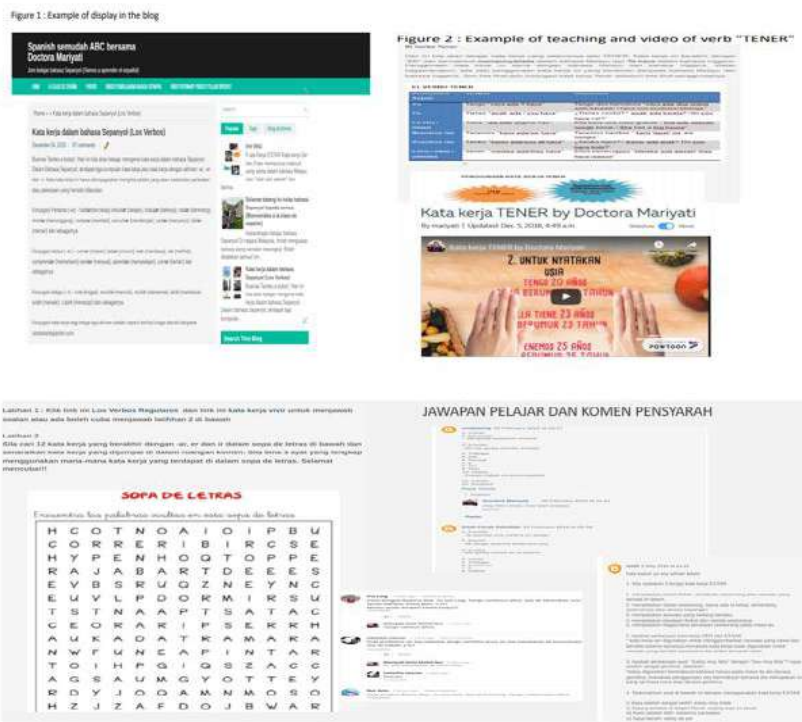

Figure 1 : display of the blog

2. Why are they important to education?

This research will support the three shifts mentioned in the Malaysia Education Blueprint (2013-2025), and Framing Malaysian Higher Education 4.0: Future-Proof Talents especially regarding the aspect of a future-ready curriculum: (a) transformative learning and teaching delivery, and (b) immersive experiential learning. The three shifts mentioned in the Malaysia Education Blueprint are as follows: a) Shift 1: Holistic, Entrepreneurial and Balanced Graduates – the innovative immersive blended learning pedagogical via blog basically assists in decisionmaking based on the principles of innovative pedagogies which tie in with the capabilities of technological learning tools and immersive blended learning cycles. This can improve graduates' quality across intellectual, emotional, and physical dimensions, which in turn, leads to the betterment of society. b) Shift 3: Nation of Lifelong Learners - this research supports this shift by providing support for lifelong learners at all points in their learning journey. c) This can happen through an enabler of Shift 9: Globalised Online Learning, where digital technologies are now considered as part of the popular trend in tertiary education to improve learning effectiveness in lifelong learning environments. In addition, One of the six key attributes in our education is needed by every student to be globally competitive is bilingual proficiency: Every child will be, at minimum, operationally proficient in bahasa Malaysia as the national language and language of unity, and in English as the international language of. The Ministry will also encourage all students to learn an additional language including Spanish.

3. Advantages of your innovation / product development / design / process towards education and community.

i) Findings from the survey with the students

- Students agreed that this blog helps them learning Spanish language through online outside from classroom.
- To increase of student's understanding and also helped in augmenting new Spanish language vocabularies.
- This blog helped student to understand Spanish language grammar better.
- The students were strongly agreeing that lecturer explanation in discussing the content such as notes, videos, questions and exercises for each topic were clear and easily
- Students agreed that the content and topics taught in the blog suited the student's skills level and in line with the things taught in classroom.
- Students would refer to the notes or content in the blog other than books and other materials before seating for written and speaking tests.
- The information given in the blog including notes, teaching video and evaluation suited the teaching and learning needs.

- The lecturer also helped students by sharing previous student's projects with the current students. This knowledge sharing could increase student's knowledge and understanding related to the tasks.

ii) What is/are the strengths of this blog in helping student to learn Spanish language?

Findings from this interview question related to the strength of Spanish language blog on students could be divided into three aspects; user friendly, interactivity and design also usage and suitability on student. The findings from this interview are as followed:

a) User Friendly

- We can easily access and learn Spanish Language outside the classroom and can learn Spanish language at any time
- There are translations in Malay language and interesting pictures
- This blog attracts my interest to learn and easily access and understood when being read.

b) Interactivity and Design

- This blog has explanation in Malay language which ease student to understand the Spanish language context
- Simple information and explanation and easily understood
- Detailed explanation and positive feedbacks from lecturer in this blog.

c) Usage and Suitability

- This blog gives opportunity for us to explore the video content which are interesting such as exercises and tasks on verbs and other previous student's tasks
- This blog has summarised the topics taught in classroom.
- This blog gives me better understanding on Spanish language with the provided exercises.
- Notes are given in detailed before the task, Malay language used is easily understood.

The usage of this blog in teaching and learning has given positive impact on student's mastery, increasing the comprehension, adding new vocabularies, improving student's achievement also giving more exciting learning experiences to students in learning Spanish language

4) Commercial value in terms of marketability or profitability of innovation / product development / design

In the process of being made into mobile applications, e -books and websites that are based on an active, conducive approach as well as using innovative pedagogy to improve students' language skills and subsequently students can compete globally.

Acknowledgement

This paper is based on the research project entitled "Pembangunan E- Pengajaran dan pembelajaran bahasa Sepanyol bagi meningkatkan penguasaan bahasa asing dalam kalangan pelajar UPSI secara atas talian". The authors would like to extend their gratitude to the Research Management and Innovation Centre (RMIC), Sultan Idris Education University (UPSI) for the University Research Grants (code: 2019-0201-106-01) that helped fund the research.

References

Nor, M. M., Zin, H. M., & Ramli, H. (2021). Student's Perception on The Usage of Spanish ELearning Blog as Online Medium to Strengthen Their Mastery and Comprehension. *International Journal of Academic Research in Business and Social Sciences*, 11 (3), 625-643.

Spanish Blog (2021) retrieved from qisyadni@blogspot.com

i-2tor: THE 21ST CENTURY APPROACH FOR EDUCATION PLATFORM

Joanna Ng Row Yee

Faculty of Hospitality, Tourism and Wellness, University Malaysia Kelantan
Joanna.h18a0739@siswa.umk.edu.my

Muhammad Faizul Hakimi Bin Kamaruzzaman, Nur Farah Hanis Binti Jalalol Khaizi, Nur Zahidah Binti Muhamad Taher, Mazlan Bin Radzwan, Lelia Nastasia Binti Amli & Roslizawati Binti Che Aziz

Faculty of Hospitality, Tourism and Wellness, University Malaysia Kelantan
faizul.h18a0257@siswa.umk.edu.my, Jalal.h18a0374@siswa.umk.edu.my, zahidah.h18a0434@siswa.umk.edu.my,
mazlan.h18a0211@siswa.umk.edu.my, lelia.h18a0185@siswa.umk.edu.my, roslizawati@umk.edu.my

Highlights: Classroom or lecture that's long and drawn-out is unenjoyable. And that means it's ineffective. i-2tor is a mobile learning app that uses the power of microlearning to make an impact on users. i-2tor can be used by lecturers, students or parents because it allows parents to access or review their tasks. The i-2tor apps has three major elements: Daily activities (D), Education (E) and Health (H) hence it provides a way to make learning more motivating, allowing students or teachers to actively engage with their gadgets to continuously learn anywhere. More importantly, i-2tor also encourages users to complete tasks perfectly to receive rewards as encouragement.

Key words: Education Application, Daily activities, Health Element, Student Achievement, UMK Portal.

Introduction

In this 21st century, science and technology are rapidly changing the world. With the rise of information and the global economy and consumer culture, information technology (IT), it is becoming more and more useful to human beings. Online teaching and learning have become increasingly common in higher educational institutions. These higher educational institutions realize the growing importance of online learning in Information systems/ Information technology (IS/IT) education and are now offering online IS/IT courses and programs to students. However, designing, developing, teaching, and assessing an online IS/IT course effectively is often a challenge. Many IS/IT instructors are new to online teaching and need orientation and training for their own readiness in designing, developing, teaching, and assessing IS/IT courses in the online environment. It is recognized that effective faculty are key to student success in online courses and to the success of online programs.

E-learning is an important tool for everyone to learn, work and participate in the family activities at the same time (Jadhav & Charak, 2019). This flexibility is reflected in other modes of delivery including Internet use (Harriman, 2014). With the rapid extension of the education approach, thus i-2tor apps is develop as an incentive system that helps users to set clear and understandable goals. The main idea of the i-2tor concept is inspired by the use of UMK E-Campus concept such as achievement level board which it is based on the number of times one's student visits the course and the tasks completed. The E-Campus ladder shows that most students have reached level 10 but there is no gain after reaching level 10. At the same time, some students will think that completing the task given in the E-Campus is not important, which indirectly makes them less motivated to organize their notes and schedules. Therefore, it is believed that the i-2tor apps is suitable for all users to set a clear schedule and provide rewards as an encouragement when completing task.

Contents of the application

Classroom or lecture that's long and drawn-out is unenjoyable, which means that it's ineffective. **i-2tor** is a mobile learning app that uses the power of microlearning to make an impact on users. In as little as 5 minutes a day, users can learn and reinforce important training topics. i-2tor is an application created to be a teaching and learning platform while emphasizing the health of users. "i" is refers to the internet and "2-tor" originated from the word of "tutor". The objective of this project is to develop an education prototype which combine three main elements such as daily activities, education and health.

Daily activities included Google meet, Google drive, Gmail, Google calendar and etc. Users can organise their jobs by using which application needed. The i-2tor provide a platform which doesn't required users to download the application separately and such applications are link together. In addition, i-2tor also designed to take care of user health through the health elements page. Other than that, it is to improve the user's motivation to complete the tasks perfectly and increase the enthusiasm of users to constantly competed their work within the time frame. At the same time, i-2tor can be used by lecturers, students and parents which allows them to access or check children's tasks.

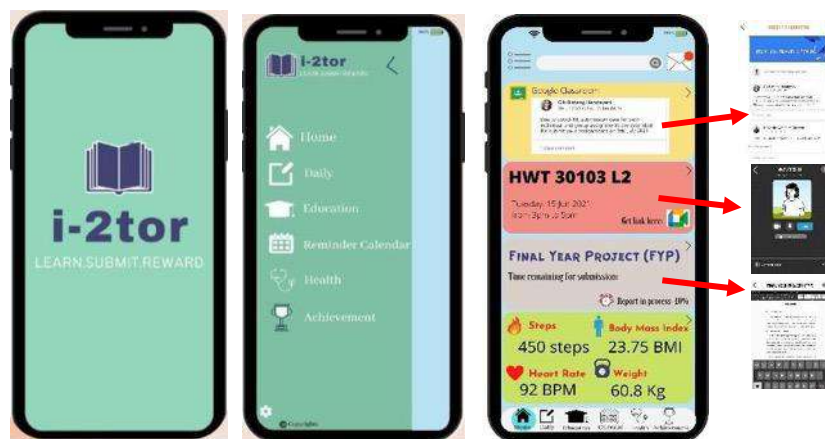

Figure 1. The ways to check the notification and access the task.

The elements in i-2tor can encourage action from users who might otherwise lack sufficient intrinsic motivation to commit to their goals. For example, users can learn a new language or do exercise regularly. The home page of i-2tor link with the application for all activities to be performed by the users and it also may assist users to coordinate each activity and displays each job that needs to be completed as a reminder. In addition, the i-2tor was set up a reminder calendar that helps users to manage time effectively. To perform well, thus users need to create reminders of class time, meeting time and exercise time according to their schedule. The achievement page will serve as an indicator of achievement and progress. Each task is set as a reminder and complete the task in the timeline. The display achievement banner will pop-out to show their daily performance. In this apps, there will be a complete TICK box (green, orange and red) where it will represent as follow:

AWARD	MARKS/ ACHIEVEMENT	COLOUR
GOLD	21- 30	GREEN
SILVER	11-20	ORANGE
BRONZE	1-10	RED

Using this approach, i-2tor will contribute a huge impact to user besides may create a positive attitude which will lead to high level of motivation, engaged, and producing better results. Lastly, i-2tor is aimed at education professionals in the public and private sectors and has high market competitiveness. It is because it gathers the needs of the public to make users more open and easier to learn. This laid-back approach can assist users in reducing the stress related to Online Distance Learning (ODL).

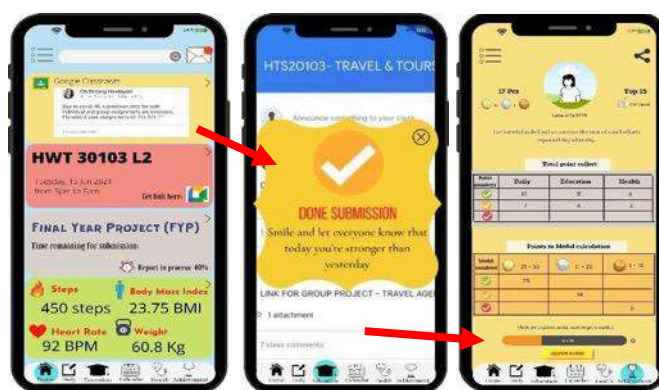

Figure 2. The ways to check get achievement from each completed task.

Benefits and value added

Based on the process development of this apps, it is believed that i-2tor able to encourage and enhance students' motivation in achieving their goals. With three main elements in this apps; Daily activities (such as google apps), Education (e.g; UMK portal) and Health (e.g; BMI measurement, blood test), i-2tor are able to monitor the health status of the users while they are doing daily assignments. It is important to ensure the quality of life and simultaneously may create a healthy lifestyle of the users. In addition, the development of this apps is aligned with the requirement of the users where everybody is facing and adapting new norm of life which is using online activities in daily life.

The i-2tor apps is the first-hand integrated education platform which combine the elements from UMK portal, Moodle as well as the few existing Google apps. As mentioned before, the main idea of this apps is to create a transformative education platform while maintaining and enhancing the motivation of the users (particularly from student's perspective). Using this apps as well, it is able to create reminders such as for class time, meeting as well as for exercise allocation time. This is important to ensure the healthy life of the users. Due to heavy duties or working responsibilities, most users they are not able to manage their time effectively hence may affect their healthy condition. Thus, it is believed that the development of this apps may contribute to the development of user's life-management and increase their level of motivation to do their job effectively.

Acknowledgement

Thanks to everyone who contributed to this innovation project from the sketch to the final prototype process. All kinds and effort given are much appreciated.

Reference

- Jadhav, R. D., & Charak, K. S. (2019). *E-Learning Methods: Education 2.0*. Advance and Innovative Research, 6(1), 80.
Hariman, G., (2014). *E-Learning Resources*. Retrieved from: <http://www.grayhariman.com>.

NEARPOD: APPLICATION OF INTERACTIVE VIRTUAL REALITY IN TOURISM COURSES

Nurzehan Abu Bakar

Universiti Malaysia Kelantan, Kota Bharu, Malaysia
nurzehan.ab@umk.edu.my

Marlisa Abdul Rahim, Nor Maizana Mat Nawi, Siti Salina Saidin, Suchi Hassan

Universiti Malaysia Kelantan, Kota Bharu, Malaysia
marlisa@umk.edu.my, maizana.mn@umk.edu.my, salina.s@umk.edu.my, suchi.h@umk.edu.my

Highlights: The COVID-19 pandemic has had an impact on education, particularly in tourism education. The COVID-19 pandemic has affected the education sector, especially in tourism education. All educators in travel, tourism, and related fields are struggling to find a more appropriate method of delivering a lesson, given that the commonly used method, field trips and practical classes, are no longer feasible during the pandemic.

To tackle this issue, Nearpod is used as the primary delivering method for tourism lessons. Nearpod help tourism educators combine their lessons with interactive features, real-time assessments, games and virtual reality. This interactive virtual reality learning experience made the tourism lessons more engaging and fun!

Keywords: *interactive virtual reality, learning, experience, Nearpod and tourism course*

Introduction

The spread of COVID-19 has sent shock reactions throughout the globe. This pandemic has affected almost all areas, including the economy, businesses, social life, and politics. The educational systems were abruptly disturbed too. In response to lockdown procedures due to the pandemic impact, higher education institutions (HEIs) such as universities are forced to close their premises (Schleicher, 2020). Around 1.598 billion students were affected and required to stay at home due to their educational institution's close at all levels in 194 countries. (United Nations Educational, Scientific, and Cultural Organization (UNESCO), 2020).

Many HEIs set out their endeavours to use technology to encourage remote learning, distance education, and online learning during the COVID-19 pandemic (Owusu-Fordjour, Koomson & Hanson, 2020). However, this massive shift towards online learning presents many challenges to school management, educators, parents, and students alike, particularly for tourism subjects. Among the problems faced include difficulties in controlling online classes, run active learning tasks, dealing with distraction, no field trip due to travel restriction, and a drop in student engagement. Such issues have reminded educators that effective online learning can only happen when we are engaged, energetic, and focussed. Therefore, educators have to find the right tools to ensure online learning is conducted smoothly and interestingly.

Nearpod is the best solution to keep the lesson interactive and fun. The authors decided to use Nearpod in tourism subjects as it provides flexibility to the educator in delivering engaging online lessons at student-paced or educator-paced. By having Nearpod as a tool in delivering lectures, the authors find out that the student interactions are soared, and the students are motivated to participate in class even when there is a poor internet connection.

Content

Typically, educators will use normal PowerPoint presentation when delivering tourism lectures online. However, this slides presentation is viewed as boring and commonplace as it fails to capture students' interest or to excite them. But with Nearpod, educators are able to excite students. It allows educators to upload their presentations and add interactive activities to complement the learning experience in the online classroom. Following are some of the approaches commonly used by the authors:

i) Field trip (virtual reality)

The authors decided to use virtual field trip features in Nearpod as it allowed tourism students to travel to any place in the world virtually during the pandemic. Students can explore virtually the world-famous landmarks, wonders of the world, national monuments, world heritage sites, and many more, which complement the learning objective. During the VR Field Trip, students will be able to explore a 360 image of all tourist attraction on their own device. They can rotate around their devices and zoom the image to explore different tourist attraction with different angles.

Figure: Examples of VR in HTS10203 (Tourism Geography)

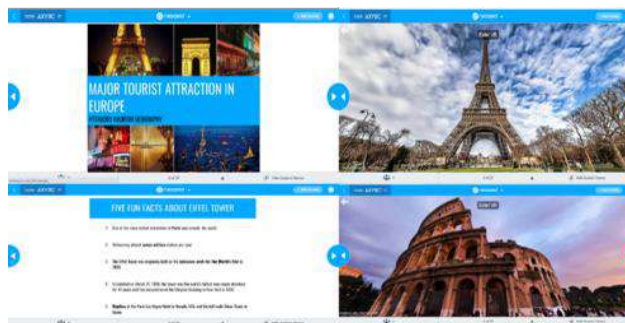

ii) Interactive activities

Authors add activities such as real-time formative assessment in their lessons to test students' understanding of subject matters. Usually, authors will include quizzes, polls, fill-in-the-blank, matching pairs in their lessons. Sometimes, Authors also used features like "collaborate", where students can write virtual post-its about their thought on particular topic. To end the lesson, the authors will use a game to test students understanding of subject matters. Authors used this feature as it allows them to get real-time feedback and post-session reports. This instant feedback allows authors to identify and help students who have misconceptions on the subject matter quickly.

Figure: Interactive formative assessment used in HTS10203 Tourism Geography subject

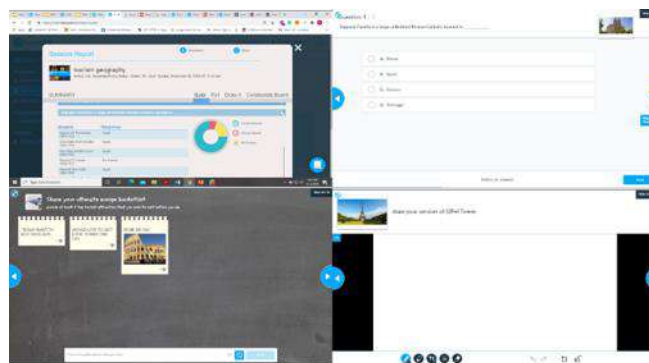

iii) Commercial Value

Nearpod is not only suitable to be used in tourism subjects. But it can be shared as a great educational lesson in any kind of teaching and learning. It is suitable for any students' level, either they are in pre-school, primary school, secondary school, or tertiary level.

Acknowledgement

We are entirely grateful to the immense and continuous motivation from Universiti Malaysia Kelantan for allowing us to conduct this study. We would also like to acknowledge the Faculty of Hospitality, Tourism and Wellness and the intensive support from the Center for Academic Excellence and Development (PKPA) of Universiti Malaysia Kelantan for support and feedback on all activities from the beginning to the end of the study.

References

Nearpod. (2020). Enjoy Nearpod on any device! Retrieved 30 August, 2020, from <https://nearpod.com/blog/enjoy-nearpod-on-any-device/>.

Owusu-Fordjour, C., Koomson, C. K., & Hanson, D. (2020). The impact of COVID-19 on learning—The perspective of the Ghanaian student. *Eur. J. Educ. Stud*, 7, 1-14.

UNESCO (2020). COVID-19 Educational Disruption and Response. Retrieved 4 December 2020, from <https://en.unesco.org/covid19/educationresponse>.

DIGITALIZED SUSTAINABLE SCIENCE COURSES THROUGH E-LEARNING INTERACTIVE APPROACH

Noor Syuhadah Subki

Faculty of Earth Science, Universiti Malaysia Kelantan
syuhadah@umk.edu.my

Highlights: This article highlights on the interactive approached used in learning Sustainable Science courses. The interactive approach using online tools as one of the e-learning platforms gives a fresh and different style of learning process for students through participating in created activities such as synchronize and asynchronized classes, educational games, animation videos, online test and many more.

Key words: *interactive, e-learning, synchronize and asynchronized, animation videos.*

Introduction

In this pandemic situation, technology has become a very crucial part of our daily life. The use of technology is not only for entertainment and communication, it is also has become one of the important platforms in teaching and learning. Nowadays, e-learning has become an important part of the education system and has changed the view of teaching and learning process as a whole. Advancement in internet and multimedia technology is the basic enable for e-learning.

E-learning is the process of extending learning or delivering instructional resource sharing opportunities, to locations away from a classroom, building or site, to another classroom, building or site by using video, audio, computer, multimedia communications, or some combination of these with other traditional delivery methods (Wani, H. 2013). E learning can be divided into two basic types, which are 1) consisting of computer-based and 2) the internet-based e-learning (Algahtani, 2011). The interactive approach used in e-learning by using many internets based and multimedia tools will help to enhance students' better understanding and performance.

Description

In Sustainable Science Courses, students from year one till year four will be introduced with environmental concepts in via conventional and online lectures. Apart from that, lab conducts are taught for in order to give skills and experience for students in the field. But during this pandemic situation, all teaching and learning process have to be done online. This situation has given a new challenge to all teachers and educators to perform online teaching and learning in a fresh and fun way. In order to digitalized the teaching and learning in sustainable science courses, the approach have been divided into six parts consisting of 1) synchronize or asynchronized lecture, 2) online attendance, 3) discussion and reflections, 4) project monitoring, 5) online quizzes and 6) assignments.

As an introduction for the course, a short animation of audio-visual is created to build an excitement among students and increase their engagement. It promotes a better understanding in a fun way and encourages students to learn more about the course. Besides that, a synchronize lecture will also be performed to have two-way communications with the students through different types of tools.

Activities such as interactive discussion through padlet platform give real time interaction between students and instructor. Students are given task in terms of projects in the field and required to report their progress through this platform. Discussions and reflections on each topic for each lecture will be also done through this platform.

Quiz is also created as one of the activities that will help to evaluate the students' understanding on the topics in the courses. Besides that, quiz is also used in this course as one of the educational games and activities to help students learn and understand topics related to law and regulations. This kind of educational games will assist the students to have better understanding and familiar with the law and regulations related with the course learned.

Most of the sustainable science courses need the students to share and engage the knowledge that they have learnt with community. Therefore, community engagement approach using social media has given a new way for the students to share their knowledge with the community not only around their family and friends but to all over the world. The Figure 1 shows the interactive approach tools that have been used in teaching and learning sustainable science course.



Figure 1: Utilizing e-campus platform for Sustainable Science Courses' Teaching and Learning activities

The importance and advantages

Based on the conservative methods applied in Sustainable Science courses conventional lectures, learners had difficulty in visualizing and applying knowledge practically. Hence, in order to sustain the learning process of this course some enhancement is required. In this paper, it is proposed to incorporate virtual objects when blended with real world. It is aimed to amalgamate entertainment and study by providing immersive learning experience to learners. The expectation with this enhancement is to impart a great deal of knowledge and better learning outcomes for Sustainable Science Courses. By using all these e-learning tools, students will have experience to explore and discover virtually the contents of the courses via many e-learning media such as you Tubes and online documentary in their own spaces. The better visualization of the content keeps learners active during the learning process as it enhances human ability to understand and process information (Serio et.al., 2013).

Fully utilizing all e-learning tools in Sustainable Science Courses had proved to enhance student understanding by comparing the results for two consecutive semesters. It is proved that the total numbers of student score A in the subjects are increasing as shown in Figure 2.



Figure2: Difference between students' result in two difference semesters

Acknowledgement

I would like to thank you to Faculty of Earth Science, UMK for supporting my journey in promoting virtual learning of Sustainable Science courses as teaching tool for globally.

References

Algahtani, A.F. (2011). Evaluating the Effectiveness of the E-learning Experience in Some Universities in Saudi Arabia from Male Students' Perceptions, Durham theses, Durham University.
 Serio, D., Angela, B.I, Carlos, D.K. (2013). Impact of an augmented reality system on student's motivation for a visual art course. Computers & Education, Vol 68. pp.586-596.
 Wani, H. (2013). The Relevance of E-Learning in Higher Education. Jurnal Kajian Pendidikan, 3(2), 181 – 193.

THE USE OF STUDY APPS IN IMPROVING STUDY HABITS AMONG UNDERGRADUATE STUDENTS

Khairul Hisyam Bin Baharuddin

Universiti Malaysia Kelantan, Bachok, Malaysia
khairulhisyam@umk.edu.my

Nazatul Syima Binti Mohd Nasir, Nor Hazwani Munirah Binti Lateh

Universiti Malaysia Kelantan, Bachok, Malaysia
syima.mn@umk.edu.my, hazwani.l@umk.edu.my

Highlights: This study investigates and analyses the use of 50 students who use the applications using a questionnaire survey and quantitative statistics. The research discovered that various study applications had varying degrees of beneficial effect on the development, perseverance, and advancement of study habits.

Key words: *study applications, study habits, study motivation, studying practices*

Introduction

Attitudes regarding the usage of mobile applications may be heavily influenced by emotions such as mood and ethical concerns, as well as frequency of use, familiarity and addictions, cost, and the actual physical characteristics of the medium. In terms of mood, Yang (2013) discovered that young American customers (i.e. students) saw mobile applications as an excellent source of entertainment and enjoyment. On the ethical front, Phau et al. (2014) discovered that individual attitudes about digital piracy of movies were influenced by individual emotions toward digital piracy, and that moral judgement and social habits had both a detrimental and positive impact on digital piracy. Wei and Lu (2014) discovered that individual satisfaction played the most significant part in why individuals joined mobile social games in a research on why people play mobile social games, while Qiaolei (2014) discovered that men tended to be more prone to internet addiction than females. The author also discovered that online gaming has a significant impact on internet dependency. In terms of cost, Bhave et al. (2013) discovered in their research that Generation Y was unwilling to pay for applications; in fact, if one app charged for utility, there were others that provided the same for free.

As regards the physical characteristics of applications, Wong (2012) highlighted device commonality and interconnection as concerns, as well as the device's "educational friendliness," i.e. tablets are more user friendly than phones owing to their larger screen size. Many studies have been conducted on the "usability" of mobile applications. Harrison et al. conducted one such thorough research (2013). They discovered that the increased utility of mobile devices often comes at the cost of their usability in certain situations. The authors went on to say that technology developers frequently forget that users want to use their devices on the go, so issues like small screen sizes, limited connectivity, high-power consumption rates, and limited input modalities are critical, as is an often-overlooked factor called cognitive overload. These results supported previous research, such as that of Zhang and Adipat (2005), who highlighted a variety of problems, such as "mobile context" (i.e. users are not bound to a particular place) and may have their attention diverted by engaging with others or the surroundings; and "connectivity" (i.e. slowness and unreliability). This may limit app performance; "small screen size" (which improves portability but limits information content); "different display resolution" (which affects image quality); "limited processing capability and power" (which improves portability but limits certain app usage); and finally "data entry methods" (i.e. less capability than desk or laptops so increases the likelihood of erroneous input and decreases the rate of data entry).

This study investigates and analyses the use of 50 students who use the applications using a questionnaire survey and quantitative statistics. The research discovered that various study applications had varying degrees of beneficial effect on the development, perseverance, and advancement of study habits. They enrich people's use of time by making it more engaging and meaningful. More than half of those polled think that the usage of apps may successfully alleviate the stress of daily living. Many study app features significantly extend people's activity and communication area. They promote the habit of studying and enhance the study structure. In summary, study applications have a beneficial effect on students' lives. There is no question that study apps have a large commercial potential, but they need also be improved in terms of professional and customised services.

Content

The use of a study application helps students to improve their concentration and manage their study habits in a better way. Students are often distracted by the various information that is presented to them and require a platform to manage the abundance of information besides managing their study routines. Since many educational institutions focus on exam-oriented testing, students' ability to manage their time and resources wisely will help them in their studies in terms of forging good study habits. Students have better control of their time and resources to manage their studies in a better way. Possibility to include the study app as a tool to help students manage their time on e-learning platforms.

References

- Bhave, K., Jain, V., & Roy, S. (2013). Understanding the orientation of gen Y toward mobile applications and in-app advertising in India. *International Journal of Mobile Marketing*, 8(1).
- Jiang, Q. (2014). Internet addiction among young people in China: Internet connectedness, online gaming, and academic performance decrement. *Internet Research*.
- Phau, I., Lim, A., Liang, J., & Lwin, M. (2014). Engaging in digital piracy of movies: a theory of planned behaviour approach. *Internet Research*.
- Wei, P. S., & Lu, H. P. (2014). Why do people play mobile social games? An examination of network externalities and of uses and gratifications. *Internet research*.
- Wong, S. H. R. (2012). Which platform do our users prefer: website or mobile app?. Reference services review.
- Yang, H. C. (2013). Bon Appétit for apps: young American consumers' acceptance of mobile applications. *Journal of Computer Information Systems*, 53(3), 85-96.
- Zhang, D., & Adipat, B. (2005). Challenges, methodologies, and issues in the usability testing of mobile applications. *International journal of human-computer interaction*, 18(3), 293-308.

ERAol: A-10 MINUTES FORMATIVE EVALUATION APPROACH

Siti Hajar Ya'acob

Faculty of Earth Science, Universiti Malaysia Kelantan Jeli Campus, Kelantan, Malaysia
hajar.y@umk.edu.my

Siti Aisyah Nawawi, Noor Syuhadah Subki, Nor Shahirul Umirah Idris, Wong Hie Ling

Faculty of Earth Science, Universiti Malaysia Kelantan Jeli Campus, Kelantan, Malaysia
aisyah.n@umk.edu.my, syuhadah@umk.edu.my, shahirul@umk.edu.my, hlwong@umk.edu.my

Highlights: A concept for a 10-minutes online formative assessment was proposed and initially executed and called as ERAol. Through online learning, ERAol is an in-depth learning approach that aims to enhance the understanding level among students who attend the Environmental Risk Assessment (ERA) course. The course aims to integrate existing knowledge that requires students to critically analyze environmental issues, followed by proper risk assessment execution. Thus by using the ERAol enables students to alert by defining their learning progress continuously. Also, the method is expected to instantly identify week to week progress of students' acceptance for the course contents.

Keywords: *online assessment, environmental risk, interactive learning*

Introduction

The pandemic of COVID-19 gave no other choices for educational institutions across the globe to adapt and adopt online learning. Other regular terms used for describing online learning are computer-mediated learning, distributing learning, and e-learning (Rudestam & Schoenholtz, 2010). The teaching and learning are enhanced using various interactive online learning tools to make the online learning ambient interesting and student-engaged. Close (2020) mentioned that the crucial elements in choosing the correct online content delivery and meaningful assessment are the practical purpose of fulfilling high-stakes or low-stakes.

Content

The subject of ERA is a cross-disciplined course offered in Sustainable Science Program. Worth mentioning, the course learning outcome (CLO) for the ERA subject and the Programme Learning Outcome (PLO) of the Sustainable Science Program are relevant to address the Sustainable Development Goals (SDGs). In conjunction to achieve the CLO and PLO, the ERA course outline requires the enrolled students to integrate and incorporate their existing knowledge gained from previously offered fundamental courses. Thus, the ERAol approach was designed to facilitate the students' learning engagement during the ERA course. First, the ERAol adopt several user-friendly interactive tools for collectively assess students understanding of each weekly topic, conducted during a pre-and post- lecture session. The tools were either Kahoot, online quizzes and games, or an e-campus blog which only consume less than 5 minutes of each lecture session. Secondly, the ERAol applied 'The Minute Paper' approach, a reflection tool that promotes students to identify what information they gathered most challenging during the online lecture. The reflection approach helped to determine if the students needed further assistance. Thirdly, knowledge-based feeling rate via the google form tool was applied, which provided space for the students to rate themselves their intensity of feeling based on their knowledge-gathering during the online lecture. Emphasization was also given to ensure students could grab technical skills for risk analysis using an online laboratory demonstration. A recorded video of the risk calculation demonstration was employed. As a result, the learning activities in ERAol helped the students analyze environmental problems such as water, air, noise, and other types of pollution using appropriate and effective risk assessment, and then able to propose a well-inform solution.

Acknowledgment (if any)

The authors are grateful for the assistance received from the Faculty of Earth Science, UMK Jeli Campus.

References

- Close, B. (2020). Assessments in virtual environment. <https://www.davinci-ed.com/resources/assessments-in-a-virtual-environment>
- Rudestam, K. E., & Schoenholtz, J. (2010). The flourishing of adult online education. In Handbook of online learning.
- Weinger, M. (1999). Teacher's guide on basic environmental health. Oxford University Press, Inc., New York. <http://www.oup-usa.org>

**SUBMIT A MOBILE APPLICATION FOR ASSIGNMENT DUE DATES MANAGEMENT:
A MOBAGOGY**

Siti Afiqah Binti Zainuddin

Universiti Malaysia Kelantan, Kelantan, Malaysia
sitifiafiqah@umk.edu.my

Noorul Azwin Binti Md Nasir, Tahirah Binti Abdullah, Noorshella Binti Che Nawi, Wan Farha Binti Wan Zulkiffli, Mohd Nor Hakim Bin Yusoff, Siti Salwani Binti Abdullah, Ahmad Ridhuwan Bin Abdullah, Siti Rohana Binti Mohamad, Siti Nurul Shuhada Binti Deraman, Nur Farahiah Binti Azmi, Nur Izzati Binti Mohamad Anuar, Nik Alif Amri Bin Nik Hashim and Hazriah Binti Hasan

Universiti Malaysia Kelantan, Kelantan, Malaysia

azwin@umk.edu.my, tahirah@umk.edu.my, norshella@umk.edu.my, farha@umk.edu.my, hakimbin@umk.edu.my, salwani.a@umk.edu.my, ridhuwan.a@umk.edu.my, rohana@umk.edu.my, shuhada.d@umk.edu.my, nurfarahiah@umk.edu.my, nurizzati.ma@umk.edu.my, alifamri@umk.edu.my, hazriah.h@umk.edu.my

Highlights: SUBMIT is a mobile application specially design for student and lecturer to better manage their assignment and task due dates in one place. The apps provide freedom for student and lecturer to access the important information such as task/assignment, its due dates, location for the task submission, contact directory and many more important information that is accessible anytime and anywhere from a mobile phone. No more missed task submission and penalties, student and lecturer can only focus on completing the task and submit the completed work before its due.

Key words: *Mobagogy, mobile application, e-learning, task management.*

Introduction

E-Learning is commonly known as a contemporary platform that consists of many types of computers and electronic media applications which used as communication instruments. The users of e-learning are not limited to any type or class. As long as the users have access to any devices with embedded technology, everyone can be e-learning users (Aziz et al., 2019). In modern society, it is well known among educators and students. A primary reason for this is the students can attend online classes at any time and from any location utilising E-Learning.

Mobile application usage in teaching and learning activities is one of a common type of e-learning (also known as mobagogy). Teachers and students explore better opportunities and discover new challenges as a result of the introduction of mobile learning technologies into teaching and learning activity (Karabatzaki et al., 2018). Mobile learning is a technology that is ubiquitous in nature, wireless, highly portable, and equipped with multimedia capabilities, adding a new dimension to the delivery of education (Karabatzaki et al., 2018 and, Melhuis and Falloon, 2010).

Content

There are several factors for the inclination in the usage of mobile applications in teaching and learning activities in class. Prior to its adoption in class, the usage of mobile applications is popular among e-commerce enterprises. They used to create mobile applications to reach new customer segment. This is because the mobile application successfully attracts excitement for the potential customers to buy their products and services just from a few clicks from their phone. The incorporation of mobile applications in classrooms has not far departed from this scenario. New generation alpha students and lecturers can be easily attracted to this medium of teaching and learning as it capable of creating excitement for them. Perhaps, in earlier study conducted by Litchfield et al. (2007) shows the education community has been interested in these medium mainly because they are capable of providing a number of gaming experiences which is a common entertainment experience nowadays.

With advance software and web-based application available in the market, development of mobile application is no longer complicated as before. The innovator or creator of the application can easily improve the application's features and functions to makes the application suitable for teaching and learning activities. With each new version of this application, new features that make them more convenient and affordable are introduced, and new apps that make our lives easier are constantly released by the developer. As a result of these developments, educators and researchers have begun to employ this technology to promote teaching and learning (Karabatzaki et al., 2018 and, Murray and Olcese, 2011).

In addition, Murray and Olcese (2011) opine the use of mobile devices has the potential to change how we learn by making the traditional classroom more interactive and engaging. It allows lecturers to teach without regard for time or place, allowing learning to continue after class or outside of the classroom in places where learning naturally occurs. It also enables lecturers to connect with students on a more personal level via devices they use on a daily basis, while sensing technologies enable learning to be personalized and tailored to the individual learner. Students will be more appreciated and easily attached to the learning environment. In some cases, mobile learning also allows students to participate in problem-solving exercises and complete game-oriented and open-ended project work. This experience helpful to increase engagement and participation in conducting tasks.

Furthermore, this study has similar objective with the prior studies, that is to create a technology from available sources to increase student performance in class and completing the attended course requirements. Therefore, the aim of this research project is to develop a mobile application (known as SUBMIT) that can increase student's engagement and provide better task management for them.

In line with Schuck et al. (2010), one of the major benefits of mobile-based learning is that students learn in new contexts, such as visiting "virtual" museums or galleries, or in other cultural and social situations that allow for collaborative learning and the sharing of their work via online media. The usage of SUBMIT allows students and lecturers to experience virtual task management. They have no longer worry about where they place their notes, important information, assignment due dates and more. All these documents and information are available in a virtual library or a virtual storage room of their own. In addition, this study found similar finding of Perkins et al. (2011), the learners of mobile application may have more possibilities to collaborate with each other's and develop knowledge in real-world experiences.

In terms of its commercial value, this mobile application can be easily obtained in mobile application stores such as google Appstore, apple Appstore, Samsung Appstore and many other platforms.

Acknowledgement

The authors acknowledge Faculty of Entrepreneurship and Business, Universiti Malaysia Kelantan for the facilities. Special thanks to those who contributed to this project directly and indirectly especially to my family, CRI 2021 team- mate and officemate.

References

- Melhuisk& Falloon G. (2010). Looking to the future: -M-Learning with the I-pad., 1-16
- Litchfield, A. J., Dyson, L. E., Lawrence, E. M., & Bachfischer, A. (2007). Directions for mlearning research to enhance active learning. In Annual Conference of the Australasian Society for Computers in Learning in Tertiary Education. Centre for Educational Development, Nanyang Technological University.
- Chu, H. C., Hwang, G. J., Tsai, C. C., & Tseng, J. C. (2010). A two-tier test approach to developing location-aware mobile learning systems for natural science courses. *Computers & Education*, 55(4), 1618-1627 <https://doi.org/10.1016/j.compedu.2010.07.004>
- Murray, O. T., & Olcese, N. R. (2011). Teaching and learning with iPads, ready or not? *TechTrends*, 55(6), 42-48. <https://doi.org/10.1007/s11528-011-0540-6>
- Schuck, S. R., Aubusson, P. J., Kearney, M. D., & Burden, K. (2010). Mobagogy-Mobile learning for a higher education community. In International Association for Development of the Information Society International Conference. International Association for Development of the Information Society (IADIS)
- Perkins, C., Johnson, D., & Arkko, J. (2011). Mobility support in IPv6 (No. RFC 6275)
- Karabatzaki, Z., Stathopoulou, A., Kokkalia, G., Dimitriou, E., Loukeri, P. I., Economou, A., & Drigas, A. (2018). Mobile Application Tools for Students in Secondary Education. An Evaluation Study. *International Journal of Interactive Mobile Technologies*, 12(2).
- Aziz, Hashim, Omar, Yusoff, Muhammad, Simpong, Abdullah, T., Zainuddin, S. A. and Safri. 2019. Teaching and Learning in Higher Education: E-Learning as a Tool. *International Journal of Innovative Technology and Exploring Engineering (IJITEE)*. 9 (1). 458- 463. ISSN: 2278-3075.

“SAINS KEJURUTERAAN” SMARTPHONE APPLICATION AS AN ONLINE TEACHING AND LEARNING METHOD

Mohd Sanusi Deraman

Politeknik Kota Bharu, Kota Bharu, Malaysia
sanusi@pkb.edu.my

**Rozaimah binti Mustapa, Marhaniza Ibrahim, Nurliyana Husna Ramli, Rosliza Ayob,
Anisah Jawawi**

Politeknik Kota Bharu, Kota Bharu, Malaysia
rozaimah@pkb.edu.my, marhaniza@pkb.edu.my, nurliyana@pkb.edu.my, rosliza@pkb.edu.my, anisah@pkb.edu.my

Highlights: Sains Kejuruteraan is a new application that has been developed for the implementation of Engineering Science course (DBS10012) for all polytechnic in Malaysia. This application showed the innovation in teaching and online learning for students that takes Engineering Science course. It helps student to get the material of teaching and learning easily in one platform. Link to install the application to the smartphone is https://play.google.com/store/apps/details?id=io.kodular.sanusi_ksb.DB10012

Key words: *online, learning, application, polytechnic, engineering, science*

Introduction

The spread of the Covid-19 epidemic in the country has gave a big impact to the country and the number of positive cases is increasing day by day. Therefore, the government has introduced the Movement Control Order (MCO) to curb this epidemic from continuing to spread. This order not only affected the country's economy but also the education sector. Schools and educational institutions was ordered to close and the teaching and learning sessions need to be done online.

According to Mohd Nazri Md Saad (2017), thousands of new application has being created and increasingly being used for personal matters, educational and management. Hence, a lot of school and university have developed new applications and used existing applications so that the teaching and learning process can run smoothly.

For polytechnic, a new application has been developed named Sains Kejuruteraan as a method of teaching and online learning for students that takes Engineering Science course. The Sains Kejuruteraan application was developed for the implementation of Engineering Science course (DBS10012) for all polytechnic in Malaysia. This course introduces the concept of physical needs in the discipline of engineering and the students will learn the basic knowledge of physics in identity instruction and physical engineering solutions.

Content

On 18 March 2020, the government has introduced the Movement Control Order (MCO) to reduce the spread of the Covid-19. All the government and private premises must be closed except main services such as health and security, telecommunications, retail, finance and transportation (Nur Hazirah & Masayu, 2020). All student either in school or in institution are not allowed to attend face to face class and the process of teaching and learning sessions need to be done online including for students in polytechnic. This exchange of teaching and learning process gave huge impact to all polytechnic's students especially the student that takes Engineering Science course.

Thus, one application had been created named Sains Kejuruteraan to overcome this problem. Sains Kejuruteraan is an application that been developed for the students that takes Engineering Science course at all polytechnic in Malaysia. The main objective of this application is to provide a platform where the students can get the material of teaching and learning easily.

Sains Kejuruteraan application have six main menus which is all this menu has its own function. The menu includes the information of the Engineering Science course (DBS10012), notes, lab work video, rubric, quiz and last but not least, the button to download all the content in the course. The first menu which is the information of the Engineering Science course contain the synopsis, learning outcome, student learning time (SLT), topic and assessments to be made in this course. Meanwhile, the notes menu contains all the notes for the topic that will be learn such as Physical Quantities and Measurement, Linear Motion, Force, Work, Energy and Power, Solid and Fluid and lastly is Temperature and Heat.

This application shown that the teaching and learning process of Engineering Science course had operated entirely online through mobile learning or known as m-learning system. This system allows lecturers to share academic information and all the materials through the application. This information is accessible to student at any time and place as long as the student have internet to access. Compared to conventional learning, m-learning system applies a different method. A study conducted by Chaka and Govender (2017) find out that acceptance of m-learning system among students in higher institution in the northern part of Nigeria are positive and moderate.

Besides, a study conducted by Harlina, Zubaidah & Ainee (2017) shows that interactive learning is computer assisted where stimulus material whether in the form of pictures, dialogues, tutorials or feedback answers can be obtained. From this Sains Kejuruteraan application, student can watch a lot of interesting video at the lab work video menu and do a lot of revision by answering random question at the quiz menu. This active involvement of students impacts learning and opens up a wide range of opportunities to students through interactive learning.

Interactive learning also encourages lifelong learning. If managed in an appropriate learning environment, the use of e-learning can add value to learning. In addition, the experience learning can be gained not just limited by four walls alone. As a conclusion, this Sains Kejuruteraan application showed the innovation in teaching and online learning for students that takes Engineering Science course. It helps student to get the material of teaching and learning easily in one platform. Moreover, this application not only can be access by the students in polytechnic but also suitable to use in any institution that offer Engineering Science course.

Acknowledgement

Thank you to all staff and practical students at Jabatan Matematik, Sains & Komputer in Politeknik Kota Bharu who worked hard to complete this extended abstract.

References

- Azia Idayu Awang, Azhari Zakaria, Hardyta Bujang Pata, Khairani Yaakub Noor Affandee Abdul. (2015). Engineering Science, Polytechnic Series. Shah Alam: Oxford Fajar Sdn. Bhd.
- Harlina binti Ishak, Zubaidah Mat Nor, Ainee Ahmad. (2017). Pembelajaran Interaktif Berasaskan Aplikasi Kahoot dalam Pengajaran Abad Ke-21. Buku Panduan Pelaksanaan Pendidikan Abad ke21. Institut Pendidikan Aminuddin Baki, Kementerian Pendidikan Malaysia.
- John G. Chaka, Irene Govender. (2014). Mobile Learning for Colleges of Education in Nigeria: An Educational Analysis. Mediterranean Journal of Social Sciences MCSEER Publishing, Rome-Italy, Vol 5 No 16, ISSN 2039-2117.
- Mohd Nazri Md Saad. (2017). Perkembangan Media, Multimedia dan Teknologi Maklumat Masa Kini. The International Conference on Development of Education, Environment, Tourism, Economics, Politics, Arts and Heritage (ICDETAH2017), Universiti Pendidikan Sultan Idris.
- Nur Hazirah Hairia'an, Masayu Dzainudin. (2020). Pengajaran Dan Pemudahcaraan Dalam Talian Semasa Perintah Kawalan Pergerakan. Jurnal Pendidikan Awal Kanak-kanak Kebangsaan (Special Issue), Vol. 9, 2020 (18-28) (ISSN 2289-3032 / eISSN 2550-178X).

TIKTOKING TO IMPROVE SPEAKING SKILLS: A SOCIOCOGNITIVE CASE STUDY OF MALAYSIAN ESL LEARNERS

Siti Amirah Ahmad Tarmizi

Universiti Malaysia Kelantan, Bachok, Kelantan, Malaysia
amirah@umk.edu.my

Najihah Mahmud, Amaal Fadhlini Mohamed, Ariezal Afzan Hassan

Universiti Malaysia Kelantan, Bachok, Kelantan, Malaysia
najihah.m@umk.edu.my, fadhlini@umk.edu.my, ariezal@umk.edu.my

Highlights: Inspired by Dwight Atkinson's sociocognitive perspective of second language learning (SLL) which postulates that human mind, body, and socially mediated world as integrally intertwined in a rich and complex system of L2 learning, this research suggests that the social media TikTok can become a powerful tool to mediate learners' cognitive activities while learning to speak in English. The capacity of TikTok to provide a wide range of resources can become great scaffolding to accommodate the different needs of the learners.

Key words: *second language learning, e-learning, speaking, sociocognitive*

Introduction

The factual account of English as the global language has resulted in the need for people to be well-versed in that language so that they can have better social life opportunities. In Malaysia, English has been taught as a second language and made a compulsory subject at all levels of education (Azman 2016). Despite numerous attempts by the government to improve the standard of English among Malaysian ESL (English as a Second Language) learners, the issue of low oral performance, particularly among the university graduates, still, to a certain degree, remains unresolved (Abdul Hamid 2014; Ganeson 2018; Ken & Cheah 2012). Thus, driven by the sociocognitive perspective, this present study is conducted to provide alternative pedagogical practices using the social media TikTok, to enhance oral communication skills among Malaysian graduates.

Research question

In what ways does TikTok help improve Malaysian ESL learners' speaking skills?

Methods

This qualitative case study involved 6 undergraduate students at a public university in Malaysia. They were of mixed gender (5 female and 1 male) and mixed race (4 Malays, 1 Chinese, and 1 Indian), and their age ranged from 20 to 23 years. Since the participants' English proficiency was gauged according to their results in the Malaysian University English Test (MUET) 1, they were therefore of a mixed proficiency, comprising of Band 2 (limited), 3 (modest) and 4 (good) students. All these participants were individually interviewed to get their opinions about their personal experiences using the social media platform TikTok to improve their English oral communication skills.

Theoretical framework

This study used a comparatively recent theoretical approach of sociocognitive theory by Dwight Atkinson to analyse the collected data. According to this theory, cognition occurs in response to environmental and/or social stimuli to allow humankind to continue its existence. In other words, individuals depend partly on their biological brain and partly on environmental features to operate sensibly in public spaces. Atkinson (2002, 2010) presented this concept of sociocognition in humans in relation to SLL in terms of three different principles as follows:

MUET is a high-stakes test run by the Malaysian Examinations Council to measure English language proficiency, largely for university admissions (Rethinasamy & Chuah, 2011).

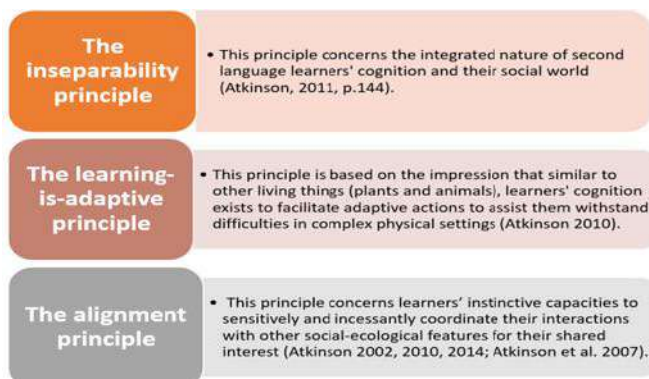

Figure 1: Three key principles of sociocognitive theory

Findings and discussion

There were four themes that emerged from the analysis of the data:

Table 2: Themes emerged from the interviews with the participating students

Num.	Themes	Description
1.	Fun and Interesting	The students claimed that TikTok had various interesting features that could become fun resources to their process of learning speaking (e.g. listening to native speakers' natural speech and accents).
2.	Autonomy	The students argued that TikTok allowed them to decide what to watch to help them improve their spoken English.
3.	Ubiquity	The students believed that TikTok was necessary in today's life; not only to learn English, but also to keep up to date with the current world events.
4.	Self-confidence	The students reported that TikTok gave them a sense of comfort while talking in English (as compared to in the classroom) and therefore being more confident with themselves.

Based on Table 2 above, it can be suggested that the interactions occurred between the students' and the platform TikTok while learning to speak English exhibited a sociocognitive phenomenon. The fun and interesting social engineered tool of TikTok developed the positive feelings in the students (cognition), before they were translated into desirable embodied actions (e.g. focusing on how native speakers pronounce words in English). The ability of TikTok to provide options to learners while experiencing their own learning can also promote learner autonomy or ownership as co-producers of knowledge, that is critical for their spoken English growth. Moreover, the students' reliance on TikTok in their daily lives may as well substantiate the connection between cognition and the sociomaterial world. As posited by Shuck, Albornoz and Winberg (2007, p.108), humans react and learn through the lens of emotionally laden experiences. Hence, when the students believed that TikTok was ubiquitous and significant, their strong sense of agency, or an individual's will and capacity to act (Gao 2010) might have been developed to motivate their learning performance as a whole. Apart from that, the feelings of security that the students experienced while talking in English on TikTok can certainly influence their self-confidence and motivation to explore the target language unreservedly.

On the whole, it appears that the social media TikTok has the potential to become an effective social and environmental affordance that enhances adaptive actions in learners, to align with the demanding process of learning spoken English. The learners' positive perceptions of that digital platform may not only influence their personalised motivation at large, but it can also organise and regulate their mental and physical activities in a manner that scaffolds their development of speaking skills.

Contributions and implications

This study contributes to the sociocognitive theory of second language learning (SLL), which, according to Atkinson (2014), is still under development. Apart from revealing strong interdependence and inseparability between learners' cognition and their social world in SLL, this study demonstrates that the learning of L2 speaking is a process of ongoing physiological activity of adaptation and alignment. That is, like other organisms that depend on their environment to prosper, learners complicatedly rely on a broad range of physical, social and conceptual resources that are co-constructed in their surroundings to enact appropriate learning actions.

This view contrasts sharply with the other two conflicting theoretical perspectives that have traditionally dominated SLL studies: 1) cognitive theory that holds mind/brain as the self-sufficient source of cognition (Harrington 2002; McLaughlin, B & Heredia 1996; O'Malley & Chamot 1990), and 2) sociocultural theory that emphasizes the important role of society and culture in the individual learner's development (Johnson 2004; Lantolf, Poehner & Swain 2018). Since sociocognitive theory highlights on the necessity to acknowledge the all-embracing constructs of sociocognition throughout the second language learning (Atkinson, 2014), it is imperative for second language teachers to make sure that all social agents and properties in the learning environment are supportive of learners' "higher-order" cognitive activities – alignment. As such, there are some pedagogical implications can be drawn from the present study in relation to the utilisation of the social tool TikTok in facilitating students' learning of speaking:

Table 3: Pedagogical implications concerning the use of TikTok in learning spoken English

Num.	How TikTok can be implemented to facilitate speaking skills	Description
	In classroom	As learners are often scared to speak English in public (especially those who have low English proficiency and low self-confidence), asking the students to create a video using TikTok may not only encourage them to speak the language, but also assist them to become independent or autonomous in improving their speaking abilities. For example, teachers can ask learners to use TikTok for digital storytelling (an online form of storytelling), in which learners use their own meaning through their multifaceted life experiences to construct the assigned story based on the lesson plans.
	Outside classroom	With the rise of online learning, TikTok is a medium that teachers can adopt to extend learning beyond the physical classroom. However, to avoid unintended outcomes (as teachers may not be physically present to monitor learners' progress), teachers must consider a range of individual and contextual factors before integrating the technology into lesson plans (e.g. the features of the tool, learners' needs and interests, etc.). For example, teachers may ask learners to create an interesting video weekly on TikTok. Learners may choose to come up with their own dialogues, lip-sync, or even sing along, to foster their creativity and full potential. Teachers may then come up with an online feedback session to make sure that learners can meaningfully experience the speaking activities, to bring them closer to the intended learning goals.

References

- Abdul Hamid, M. S., Islam, R., & Hazilah, A. M. (2014). Malaysian graduates' employability skills enhancement: An application of the importance performance analysis. *J. for Global Business Advancement*, 7(3), 181.
- Atkinson, D. (2002). Toward a sociocognitive approach to second language acquisition. *Modern Language Journal*, 86(4), 525-545.
- Atkinson, D. (2010). Extended, embodied cognition and second language 'acquisition'. *Applied Linguistics*, 31(5), 599-622.
- Atkinson, D. (2014). Language learning in mindbodyworld: A sociocognitive approach to second language acquisition. *Language Teaching*, 47(4), 467-483.
- Azman, H. (2016). Implementation and challenges of English language education reform in Malaysian primary schools. *The Southeast Asian Journal of English Language Studies*, 22(3), 65-78.
- Ganeson, D. (2018). A needs analysis of English for business students at a private university in Malaysia [Master thesis, Faculty of Languages and Linguistics, University of Malaya, Kuala Lumpur].
- Gao, X. (2010). Strategic language learning: The roles of agency and context. *Multilingual Matters*.
- Harrington, M. (2002). Cognitive perspectives on second language acquisition. In R.B. Kaplan (ed), *The Oxford handbook of applied linguistics*. Oxford University Press.
- Johnson, M. (2004). *A philosophy of second language acquisition*. Yale University Press.
- Ken, S.T.T., & Cheah, Y. (2012). Business graduates' competencies in the eyes of employers: An exploratory study in Malaysia. *World Review of Business Research*, 2(2), 176-190.
- Lantolf, J.P., Poehner, M.E., & Swain, M. (eds). (2018). *The Routledge handbook of sociocultural theory and second language development*. Routledge.
- McLaughlin, B., & Heredia, R. (1996). Information-processing approaches to research on second language acquisition and use. In W.C. Ritchie & T.K. Bhatia (eds), *Handbook of second language acquisition*. Academic Press.
- O'Malley, J.M., & Chamot, A.U. (1990). *Learning strategies in second language acquisition*. Cambridge University Press.
- Rethinasamy, S., & Chuah, K.M. (2011). The Malaysian University English Test (MUET) and its use for placement purposes: A predictive validity study. *Electronic Journal of Foreign Language Teaching*, 8(2), 234-245.
- Shuck, B., Alborno, C., & Winberg, M. (2007). Emotions and their effect on adult learning: A constructivist perspective. In S.M. Nielsen & M.S. Plakhotnik (eds), *Proceedings of the Sixth Annual College of Education Research Conference: Urban and International Education Section*, Florida International University, Miami, pp. 108-113.

MOBILE LEARNING INNOVATION: PKB FINANCIAL MANAGEMENT CALCULATOR

Norhidayah binti Mohd Salleh

Politeknik Kota Bharu, Kota Bharu, Kelantan
nhidayahms@pkb.edu.my

Madiha bt Hasbullah

Politeknik Kota Bharu, Kota Bharu, Kelantan
madihahasbullah4@gmail.com

Highlights: Mobile Learning Innovation: PKB Financial Management Calculator is an application developed for the use of teaching and learning process of Financial Management (DPA30063) and Business Mathematics (DPB20053) courses. This application is developed for improving the quality, interest and better teaching and learning outcomes for these courses. This innovation is a complement and added value to the learning and teaching process in the lecture room. Therefore, the innovation of this application has been carried out to study the usability of Mobile Learning Innovation: PKB Financial Management Calculator in terms of content, motivation and user friendly factors. Overall, the findings of the study found that the usability aspect of this application is at a high level with a value of 67.5% for June and 61.53% for December 2020 session. These findings indicate that this application is able to improve students' understanding and increase students' interest in DPA30063 and DPB20053 courses.

Key words: *teaching and learning, mobile learning, mobile innovation*

Introduction

Electronic-based teaching and learning resources have become progressively more popular in the education system currently. Through technological advances, students capable to access mobile learning easily with the use of mobile equipment such as smartphones, tablets, desktops or laptops correspondingly compared to the use of hardcopy writing notebooks that are easily damaged and not sturdy (Shuib, 2010).

Mobile learning in a teaching and learning process also is enjoyable compared to traditional teaching methods. Mobile equipment can be applied and their usage enhanced to support the teaching process of more meaningful learning. For example, as proven, university students in Korea have given a positive level of how smartphones can be used effectively to increase students' learning (Park & Lee, 2012) and also that mobile technology can have a significant impact in supporting teaching and learning (Zurita & Nussbaum, 2004).

Mobile Learning Innovation: PKB Financial Management Calculator

Traditional teaching methods that comprise lectures, group presentations and taking notes are uninteresting that will only cause students memorize the knowledge conveyed from lecturers. Students were also found have difficulty reviewing their lessons when online learning was implemented during the Covid 19 Pandemic.

Consistently, as technology increasing tremendously, mobile learning in a teaching and learning process is enjoyable compared to traditional teaching methods. Mobile equipment can be applied and their usage enhanced to support the teaching process of more meaningful learning. For example, as proven, university students in Korea have given a positive level of how smartphones can be used effectively to increase students' learning (Park & Lee, 2012) and also that mobile technology can have a significant impact in supporting teaching and learning (Zurita & Nussbaum, 2004).

As a result, the researcher took the initiative to develop Mobile Learning Innovation : PKB Financial Management Calculator. It was created as one of the options for engaging students in learning and assisting them in comprehending the topic of Time Value Of Money in DPA 30063 and DPB 20053, which is regarded one of the most critical topics to be comprehended and applied.

Mobile Learning Innovation: PKB Financial Management Calculator is developed using kodular.io software, which is an interactive eLearning method and can be used in various devices. Using kodular.io software, this application is developed to produce the appropriate formula. This software is hosted on Google Cloud Platform. Using this software, the creator doesn't need to learn any coding language. This app is done only by just drop and drag blocks. The researcher save a lot of time building a new learning apps because the app act like a mirror, any change in the online builder, it will automatically update the app and giving a real time preview of it.

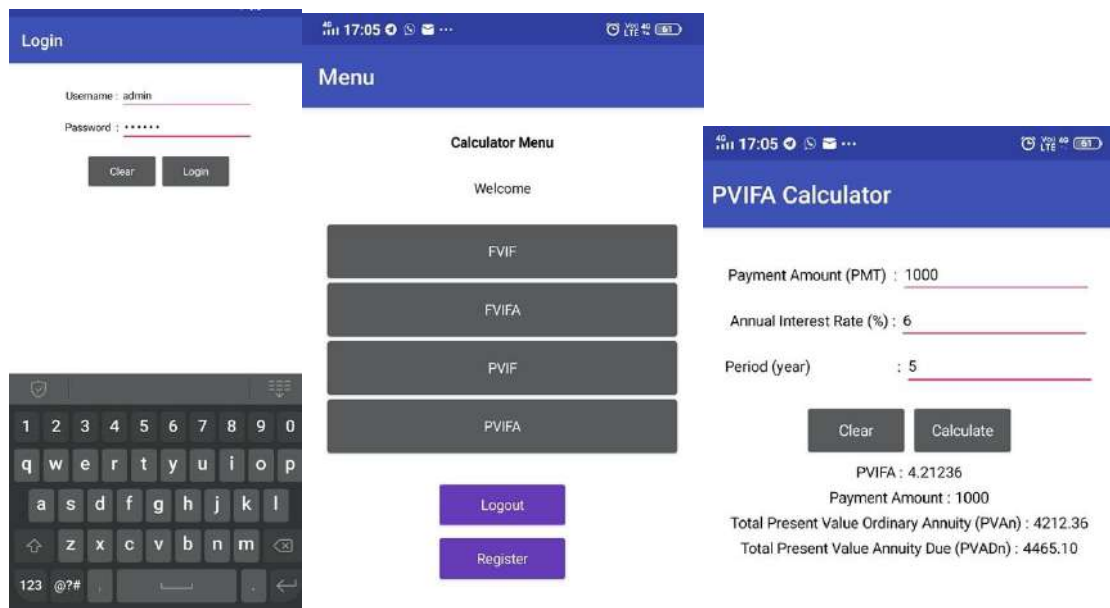

mobile learning innovation using kodular io software

The idea of producing this innovation is due to the new online teaching system now that requires students to learn a lot independently. Therefore, these innovations are produced to assist students in their self-learning. Through these user-friendly, attractive and flexible innovations, it is possible to facilitate students in their self-study sessions because these innovations are easy to upload in their smartphones only.

The purposes of this application developed are;

- i. As a complement and added value to the teaching and learning process in the lecture room. Students can also use this application when attending class in the lecture room.
- ii. Assist and encourage students to self-study Financial Management (DPA30063) and Business Mathematics (DPB20053) courses and create the self-learning process more flexible and can be carried out anywhere as long as there are internet facilities.
- iii. Provides mobile learning applications that are easily accessible via smartphones in helping students to do mobile learning.
- iv. Create learning more fun and increase students' interest in Financial Management (DPA30063) and Business Mathematics (DPB20053) courses.
- v. Helps to easily understand the calculations related to the topic of Time Value of Money for Financial Management (DPA30063) and Interest topic for Business Mathematics (DPB20053) courses.
- vi. Help students understand more clearly in actual financial management related to loan calculation methods used practically by all financial institutions and to evaluate company's performance and compare it other similar businesses in their industry.

Mobile Learning Innovation: PKB Financial Management is accessible via smartphone as after downloading. This application requires a login ID before accessing it in more detail. However, the application is free and the process of spreading its use to students does not involve any cost through the use of APK application. Overall, mobile learning is suitable for implementing to students of higher learning institutions to take advantage of mobile devices such as smartphones which are the majority had by them.

Result

The innovation of this application has been carried out to study the usability of Mobile Learning Innovation: PKB Financial Management Calculator among students for June 2020 session and for December 2020 session, who used this application. Usability of this application is studied in terms of content, motivation and user friendly factors.

Bil	Item	June 2020 (%)	Dec 2020 (%)
1	Content Factors	68.6%	59.3%
2	Motivation factors	66.5%	64.48%
3	User Friendly Factors	67.3%	60.78%
	Overall percentage	67.5%	61.5%

From the analysis conducted for June 2020 session, generally all respondents agreed this application is beneficial to them for all factors. It was found that content factors got the highest score with a value of 68.6%, followed by user friendly factors with a score of 67.3% and motivation factors of 66.5%. Overall percentage of 67.5 showing that Mobile Learning Innovation: PKB Financial Management Calculator has a high level of usability.

From the analysis conducted for December 2020 session, all respondents also agreed that this application is beneficial to them for all factors. Motivation factors got the highest score with a value of 64.48%, followed by user friendly factors with a score of 60.78% and content factors of 59.33%. Overall percentage of 61.53 also shows that Mobile Learning Innovation: PKB Financial Management Calculator has a high level of usability. Therefore, the use of this application is very suitable among students who are studying Financial Management (DPA30063) and Business Mathematics (DPB20053) courses.

Commercialisation

This innovation project is not only suitable for the use in the Financial Management (DPA30063) and Business Mathematics (DPB20053) courses at Politeknik Kota Bharu but also for all Malaysian polytechnics (33 polytechnics) and Malaysian Community Colleges (79 Malaysian Community Colleges) that have these subjects. This innovation can also be applied in IPTA and IPTS in the field of Financial Management and Business Mathematic subjects. The use of this application becomes increasingly crucial, especially in the era of Covid-19 pandemic where online learning is the major platform for the teaching and learning process at Politeknik Kota Bharu.

Conclusion

As conclusion, the use of Mobile Learning Innovation: PKB Financial Management Calculator seeks to increase students' interest in Financial Management (DPA30063) and Business Mathematics (DPB20053) courses. Correspondingly, the level usability of this application is also at a high level. Therefore, the use of this mobile application can be extended to other courses for improving the quality of teaching and learning in Malaysian Polytechnic. This is consistent with the study conducted by Masrom et al. (2016), found the implementation of learning mobile at Public Higher Education institutions shows a positive effect to be applied and should be implemented in educational institutions. Therefore, it is very appropriate for polytechnics in Malaysia to expand further use of this mobile learning method for student and lecturer benefits.

References

- Abd Rahman, R., & Mohd Hashim, M. H. (2011). M-Pembelajaran dalam Pendidikan Teknik dan Vokasional (PTV) di Malaysia.
- Ahmed, P. S., Kasi, F., & Nasseef, O. A. (2013). Mobile Phones: Under-utilized Pedagogical Devices. *Life Science Journal*, 10(4), 3128-3131.
- Bulun, M., Gulnar, B., & Guran, S. M. (2004). Mobile technologies in education. *The Turkish Online Journal of Educational Technology-TOJET*, 3(2).
- Botha, A., Vosloo, S., Kuner, J., & van den Berg, M. (2009). Improving cross-cultural awareness and communication through mobile technologies. *International Journal of Mobile and Blended Learning (IJMBL)*, 1(2), 39-53.

MODEL OF THE INFLUENCE BY FIRM SIZE ON FINANCIAL PERFORMANCE IN MALAYSIAN ICT SECTOR

Mohd Fazli Bin Mohd Sam

Faculty of Technology Management & Technopreneurship, Universiti Teknikal Malaysia Melaka, Hang Tuah Jaya,
76100 Durian Tunggal, Melaka, Malaysia
mohd.fazli@utem.edu.my

Brenda Lim Xun Li¹, Nurul Hasyimah Mohamed²

¹Faculty of Technology Management & Technopreneurship, Universiti Teknikal Malaysia Melaka, Hang Tuah Jaya,
76100 Durian Tunggal, Melaka, Malaysia

²Faculty of Business & Management, Melaka International College of Science and Technology, 75300, Melaka,
Malaysia

brendalim91@gmail.com, nurul.hasyimah@micost.edu.my

Highlights: Develop a model, the influence of firm size on the financial performance of Malaysian Information and Communication Technology (ICT) listed companies. The study utilised a sample of 53 of ICT listed companies derived from the Osiris database for the period covering 2008 – 2012. The independent variable is firm size, which is measured by proxies such as total assets, market capitalisation and total sales, while the dependent variables, firm financial performance, is measured by profitability ratios (return on assets (ROA), return on equity (ROE), profit margin). The finding of the study showed that firm size, which used the proxy of total asset, market capitalisation and total sales, has a significant effect on firm financial performance in terms of ROE. On the other hand, there is no significant effect in the result between firm size and firm performance in terms of ROA and profit margin. On this ground, the study recommended that the government or firms should implement a guideline that provides comprehensive financial information for various entities. This in turn will provides a better evaluation and qualitative judgment on companies' financial performance.

Key words: Performance; ICT, Influence; Firm Size.

Introduction

According to Prasetyantoko and Parmono (2012), bigger firms are supposed to be profitable than smaller firms, due to their large capacity and better access to their financing needs. In contrast, when in the time of economic crisis, some bigger firms would be riskier than smaller firms since the larger companies usually have more debts in their operation. Since the transition of the ICT industry from ICT manufacturing towards higher value-added ICT services, it is found that there is a decrease in the total export of ICT goods in Malaysia and a decrease in ICT manufacturing contribution towards the gross domestic product (GDP) (Malaysia Economic Planning Unit 2015). In addition, the economic slowdown has given a challenge for the Malaysian ICT sector as well as an impact on the growth potential in a developing country (Nations, 2012). Therefore, it is important to identify the influence of firm size on the performance of firms when facing economic and business fluctuations.

Total sales are more related to the product market thus it can be used to measure product market competition. Malaysia Digital Economy Corporation Sdn Bhd (MDEC, 2012), mentioned in the Multimedia Super Corridor (MSC) annual report in Malaysia, that the year-on-year total sales increased from RM21.75 billion in 2008 to RM33.53 billion in 2012. Yet, Sam and Hoshino (2013) stated that the oligopolistic price policy aims to gain higher sales revenue by minimising adequate profit, but if firms carried out too much sales maximisation, it could result in bankruptcy

Methodology

This model utilised firm size as an independent variable. In addition, total assets, total sales, and market capitalisation were used as firm size indicators. Prior researchers had used different measures to determine firm size. Total assets refer to the total net book value owned by a firm and acts as an economic value in which the assets will be expended over the time to help the firms to gain benefits (Collin, 2007). Market capitalisation reveals the public consensus on the value of a company's equity and it is important for the investors to determine the returns on their investment (Skamo, 2012). Total sales were employed as the indicator of firm size as it is one of the most popular proxies of firm size and it is more related to products market, which is used to measure the product market competition (Dang et al., 2015).

Firm financial performance is the dependent variable in this study. The profitability ratio is the variable to measure the firm financial performance because it is widely used as a measure of firm performance. The profitability ratio in this study included return on assets (ROA), return on equity (ROE), and profit margin, which were utilised as the measures of firm profitability. Some researchers used return on equity (ROE) and return on assets (ROA) as the indicators in profitability ratio to measure the financial performance of organisations.



Findings

The financial performance of Malaysian ICT listed companies and the firm size, which is measured by total assets and market capitalisation, have correlated relationships with ROA. This means that firm size will give an impact towards Malaysian ICT listed companies. However, ROA is also considered as the fundamental value of firms. On this basis, the management of the larger industry plays an important role in effectively managing the efficiencies of the profitability of the firms and it is suggested to increase the coordination requirement to be managed properly in order to reach higher profit rate and return on total assets.

Secondly, the result found that firm size has a correlated relationship with ROE and the study supported the firm size has an impact on firm financial performance. An increase in return on equity means a better rate of return on the ownership interest of the common stock owners. It shows that a significant insight towards the management of firms on the importance of management efficiency in generating profit from shareholders' equity.

The last objective is to determine the effects of the size of the firm and performance of the firms in terms of profit margin among Malaysian ICT listed companies. However, the result found that there is insignificant and no relationship between firm size and firm performance of Malaysian ICT listed companies. Profit margin was used to measure the profit earning of companies from every sales, generally if the management of the firms focused on profit maximisation and without proper managerial of the utility, price and cost will also lead to a low firm performance.

Recommendations

The management of firms are encouraged to collaborate with the internal and external researchers in order to gain more understanding on the overall financial performance and imply the adoption of some strategies that can be identified through the analysis of the study for improving the performance with high impact. Besides that, the management of the organisation, internal researchers, academic researchers and investors can adopt the analysis of the study for better monitoring and utilisation of assets and better experience in running the business so as to pursue the opportunities in growing the markets as well as increase the market capitalisation that will enhance the firms' performance. The study recommends that the government or firms should implement a guideline that provides comprehensive financial information for various entities to make a better evaluation and qualitative judgment on companies' performance. Besides, the firms should develop a management plan based on firms' characteristic, firm features, and management experience and improve on the management level to meet market demand, strengthen the market value of an organisation, and provide a better and effective assets management of the ICT firms to enhance firm performance and development.

Conclusion

Based on the aforementioned paragraphs, the study concluded that firm size has a significant influence on ROE of the financial performance of Malaysian ICT listed companies. It can be inferred that the change in firm size has an impact towards the change of return on equity of ICT firms listed in Malaysia. Therefore, the firms can increase productivity and market value to define a strategy so as to increase the financial performance of the firms. Furthermore, the study is expected to be an added leverage to the existing literature on the influence of firm size towards firm financial performance given that it provides additional empirical evidence on the effect of firm size towards firm performance. In addition, the study is expected to give more confidence to the management of the companies, and investors on the essence of utilising firm size in making their companies' decisions and also their investment decisions.

References

- Collin, S.M.H., (2007). Dictionary of Accounting Four., London: A & C Black Publishers Ltd 2007.
- Malaysia Economic Planning Unit, (2015). Strategy Paper 15: Driving ICT in the Knowledge Economy, MDEC, (2012). MSC Malaysia Annual Report 2012
- Nations, U., 2012. World Economic Situation and Prospects (2012): Global Economic Outlook.
- OECD, (2010). High-Growth Enterprises: What Governments Can Do to Make a Difference? OECD Publishing, pp.1–238
- Prasetyantoko, A. and Parmono, R., (2012). Does Firm Size Matter? An empirical Study of Firm Performance in Indonesia. International Research Journal of Business Studies, 2(2), pp.87–97.
- Sam, M. and Hoshino, Y., (2013). Sales Growth, Profitability and Performance: Empirical Study of Japanese Ict Industries With Three Asean Countries. Interdisciplinary Journal of Contemporary Research in Business, 4(11), pp.138–156.

FUND FOR FOOD: COMPLETE GUIDE TO HELP FIGHT HUNGER ON CAMPUS

Nurul Hafizah Mohd Yasin

Faculty of Hospitality, Tourism & Wellness, Universiti Malaysia Kelantan, Malaysia
hafizah.my@umk.edu.my

**Fadhilahanim Aryani Abdullah¹, Nur Haiza Nordin², Nur Naddia Nordin², Nur Dalila Mat Yusoff¹,
Nik Noorhazila Nik Mud², Siti Zamanira Mat Zaiib², Nurul Fardila Abd Razak¹**

¹Faculty of Hospitality, Tourism & Wellness, Universiti Malaysia Kelantan, Malaysia

²Faculty of Entrepreneurship and Business, Universiti Malaysia Kelantan, Malaysia

aryani.a@umk.edu.my, haiza@umk.edu.my, naddia.n@umk.edu.my, nurdalila@umk.edu.my,
noorhazila.nm@umk.edu.my, fardila.ar@umk.edu.my

Highlights: The increased living standards and price of goods are among the factors influencing food insecurity among university students. They are forced to engage in part-time jobs to earn extra income for their expenses. In view of these problems, campuses have recently established food pantries and it aims as a guideline to solve hunger and food insecurity among university students. Therefore, as new innovation novelty of this study, it is expected to become a driving force in improving food insecurity by implementing the On-Campus Food Pantry Program to help ease student hunger.

Key words: Food pantry, Fund, Student hunger, Campus, University Student.

Introduction

Inadequate financial resources have led to food insecurity among students at higher institutions due to the increase in study fees, house rental costs, and food prices. As such, the increased living standards and price of goods are among the factors influencing food insecurity among university students. In fact, hunger and food insecurity are evident in this day and age, even on college campuses. Since college meal plan for students is too expensive especially for low-income students to bear, some students are forced to engage in part-time jobs to earn extra income for food and other expenses. This also includes living on a shoestring budget as college education becomes less affordable for university students. In view of these problems, campuses have recently established food pantries to help students. However, running a campus food pantry requires careful planning and a dedicated team of leaders and volunteers; hence, this study aims to provide a food pantry toolkit as a guideline to solve hunger and food insecurity among university students by setting up food pantries on campus to provide food and other essentials to the students in need. Considering the new-developed toolkit to fight hunger on campus as the innovation novelty of this study, universities in Malaysia are, therefore, expected to become a driving force in improving food insecurity by implementing the On-Campus Food Pantry Program to help ease student hunger.

Problem Statement

Food insecurity related to people who are unable to access sufficient food at all times for an active and healthy life (Wan Azdie Mohd Bakar, Shahidah Ismail, Suriati Sidek & Rozlin Abdul Rahman, 2019). Statistic from the USDAERS (2019) revealed that approximately 37.2 million adults were low food secure at some time during 2018, including 9.5 million of them were in very low food secure status. In specific, university students are a potentially vulnerable group of people who are face food insecurity (Wan Azdie Mohd Bakar, Shahidah Ismail, Suriati Sidek & Rozlin Abdul Rahman, 2019). Students are difficult to support themselves while they were also paying for college. Four out of five students work part-time jobs, averaging 19 hours per week while attending college. Since food insecurity has become a significant issue among college students, it would be solved by implementing food pantry on campus program.

Research Objective

The purpose of this study is to produce the toolkit that provides the resources that the student government needs in order to create and operate a successful food pantry on campus program.

Content

Depending on the campus, this program is run by the student government, other student organizations, or administrative departments such as the Office of Student Affairs. Food pantry implements the concept of student help student as a solution to fight hunger among student.

Setting up a campus food pantry is a big challenge, so there is a lot of work to be done by the students. It is advisable to assemble a steering committee made up of five to ten people who will serve as sponsors of food pantry. This team of people will help to build support for establishing the on campus food pantry.

The process to start on food pantry is clearly stated as in food pantry toolkit. It comprises the following facets: i) demonstrating the need for food pantries on campus by surveying the university students, faculty, and staff members; ii) community partnership through a fiscal sponsor and potential groups or companies as community partners; iii) setting up of space, equipment, and storage depending on the type of food to be distributed; and iv) food safety procedures via training and safe food handling provided to the volunteers.

i) *Demonstrating the need for food pantry*

This first step can be implemented by surveying the needs of university students, faculty, and staff members. The food pantry needs survey was developed to help in determining the need for food pantry at campus. The purpose of food pantry would be to address hunger and food insecurity on campus. This survey should consist of accessibility of food, food budget, willingness to use a food pantry, and potential to be volunteer. Input from this survey will help organizer team clear portrait of food insecurity and hunger situation faced by the students in campus.

ii) *Community partnership*

This step can be done through a fiscal sponsor and potential groups or companies as community partners. For instance, the regional food bank which is one of the huge resource for food pantry. They can provide potentially assist with fundraising, recruit volunteers if required, offer free food bank training and program. It is advisable to have support from different agency and collaboration from different company to get sponsor.

iii) *Setting up Food Pantry*

Once, campus food pantry's foundation in place, it is the right time to figure out the physical food pantry and procedures to run food pantry. Finding a suitable location is the first thing committee need to decide. The size and type of location will vary depending on the available space, the level of need and volunteer resources. After that, food pantry committee need to decide on space, equipment, and storage which is depending on the type of food to be distributed. Complete procedure and food pantry sample floor layout can be referring in Fund for Food Toolkit.

iv) *Food safety procedures*

Food pantry committee need to arrange training and safe food handling to the volunteers. Instruction and checklist that cover the procedures for every area of the pantry should be created at food pantry. This procedure explain in details about basic hygiene to handle food, procedure for food storage for different items such as non-food items, dry stock goods, refrigerated food and frozen food as well as food packing and cleaning of food pantry.

Table 1. Description of Food Pantry Toolkit

TOOLKIT CONTENTS	DESCRIPTION
Demonstrating the need for food pantry	- Surveying the needs of university students, faculty, and staff members
Form a student enterprise	- Student enterprise/company will help students to manage this food pantry efficiently
Community partnership	- Establish a relationship with the sponsor to have fundraising, donations, or discounted products.
Setting up space	- equipment and storage supplies - waiting is - secure storage - sample floor plan
Food safety procedures	- basic hygiene - food storage - food packing - cleaning

Product Novelty

To guide the development or strengthening of food pantry on campus, the project team developed a Fund for Food: Complete Guide to Fight Hunger on Campus. The guide also provides information regarding the opportunity to apply for food pantry funds provided by Ministry of Education to run on-campus food pantry

Advantage/ Contribution

- This program can help student enhance their leadership skill, social and soft skill through student enterprise program
- Free up funds to be spent for other purposes.
- Hunger on campus should be prevented in order to help student enhance their academic performance.

Commercial Value

- Fund for Food is a complete guideline to guide on implementation of activity for University/ College to start their food pantry program.
- This project can be a great opportunities for UMK to offer consultation project on food pantry in campus or other agency.

Importance to Education

- Fund for Food: Complete Guide to Fight Hunger on Campus is important to our education system to help B40 students to survive in their campus life.
- By providing enough food for students in needs, it can help to enhanced their academic performance
- Concept of "Student help Student" was one of the initiatives to guide student enhanced their personal value and soft skill, as well as to produce first class student with good manner and performance.

Conclusion

In conclusion, universities in Malaysia are expected to become a driving force in improving the Food Bank Program by implementing On-Campus Food Pantry Program to help ease student hunger. The *Fund for Food: Complete Guide to Fight Hunger on Campus* could be the best guide to start on-campus food pantry.

References

- USDA ERS - Key Statistics & Graphics, <https://www.ers.usda.gov/topics/food-nutrition-assistance/food-security- in-the us/key-statistics-graphics.aspx> (accessed 4 March 2019).
- Wan Azdie Mohd Bakar, Shahidah Ismail, Suriati Sidek & Rozlin Abdul Rahman. (2019). Prevalence and factors affecting food insecurity among university students in Pahang, Malaysia, *Mal J Nutr*, 25, (1), 59-67.

SOUP KITCHEN AS SOCIAL ENTERPRISE STRATEGY: A RIPPLE EFFECT THEORY

Noor Raihani Zainol¹

¹Faculty of Entrepreneurship and Business, Universiti Malaysia Kelantan, Kota Bharu, Kelantan
raihani@umk.edu.my

**Anis Amira Ab Rahman¹, Shamsul Anuar Salim², Mohd Shahril Nizam Md Radzi¹, Mohd Hafis Mohd Fauzi³,
Nor Shuhada Ahmad Shaupi¹, Azila Jaini⁴**

¹Faculty of Entrepreneurship and Business, Universiti Malaysia Kelantan, Kota Bharu, Kelantan

²Kelab Kebajikan Asnaf Bachok, Bachok, Kelantan

³Center of Infrastructure Development and Management, Universiti Malaysia Kelantan, Bachok, Kelantan ⁴Faculty of Business, Universiti Teknologi MARA Johor Branch, Segamat, Johor

anisamira@umk.edu.my; shamans88@gmail.com; shahrilnizam@umk.edu.my;

hafis@umk.edu.my; shuhadashaupi@gmail.com; azilajaini@uitm.edu.my

Highlights: Food is the basic need of the people. Today, we can see many peoples prefer to order food from the restaurants or café's for different types of menus via online or physical. The soup kitchen offers scratch on-site meal preparation with many menus and soup is the basic or the special dishes with affordable price. Based on a ripple effect theory, soup kitchen expands their mission onto social innovation that align with sustainable Goals Development by United Nation. As one of the social enterprise entity, Soup Kitchen is an innovative model that focuses on profit and social impact for asnaf or low-income, disabled, and homeless people in Kelantan, as well as environment towards sustainable food impact. In other words, Soup Kitchen not only provides healthy food or ingredients to the customer, it is also the compassionate places to the children, homeless, disabled, asnaf or low income people, and who need food to survive to get food free of cost to feed them. The soup kitchen provides nutritious meals to this target groups who may not otherwise have access to healthy and balanced nutrition at home or other places. The Soup Kitchen pairs food production for target beneficiaries with educational programming including gardening and Food Service Programs.

Key words: *Soup Kitchen, Social Enterprise, Social Innovation, Ripple Effect Theory, Sustainable Food,*

Introduction

The soup kitchen cares about their customers and environment by offering a healthy food menu, which can make them feel good and can keep them from experiencing many diseases and health conditions. Obtaining adequate nutrition is an essential part of living a healthy life. Poor nutrition can result from failure to eat enough or failure to choose the right kinds of foods (Caraher & Dowler, 2016). Failing to choose a balanced diet full of nutritious foods increases your risk of developing many preventable diseases (Nagata, Palar, Gooding, Garber, Whittle, Bibbins Domingo, & Weiser, 2019). To figure out a daily nutrition plan in Soup Kitchen, we use diet tracking apps (Samoggia & Riedel, 2020). The customer can use these friendly-apps to choose the menu and also make their own preferences for the menus (they can add their ingredients and make their own menus for soup). These apps will coordinate and provide the nutrition information and advice the customer for the balanced nutrients in soup or dishes. The Soup Kitchen offers various soups as basic dishes with specific impact on health including diabetes, high pressure, cholesterol, and etc. Accordingly, the customer can choose the best meals they prefer.

As aforementioned above, the Soup Kitchen not only focuses on profit, but cares more on the target beneficiaries, who do not have access to healthy food. These target beneficiaries will be provided with healthy meal, as well as education program includes food service programs (ex. Awareness, healthy Food Training, Culinary job training, Workshops) and gardening (for the basic herbs plants, chillies, and etc.). These models penetrate social innovation design towards impactful sustainable food production, as well as the environment. The Soup Kitchen collaborates with government agencies, industry, community, and institutions for more impactful success stories. Sometimes, people want to contribute or help other people but they have financial constraints. Through the Soup Kitchen model, everyone can share healthy food and help the target beneficiaries, as well as build a healthy society.

Acknowledgement

We are grateful for the continuous support, encouragement, and insightful comments and discussion from Kelab Kebajikan Asnaf Bachok (KeKABah) members and Yayasan Kemudi Bachok.

References

- Caraher, M., & Dowler, E. (2016). Food for Poorer People: Conventional and 'Alternative' Transgressions? In Food Transgressions (pp. 227-246). Routledge.
- Alessandra, A. J., O'Connor, M. J., & Van Dyke, J. (1994). People Smarts: Bending the Golden Rule to Give Others What They Want. Pfeiffer.
- Nagata, J. M., Palar, K., Gooding, H. C., Garber, A. K., Whittle, H. J., Bibbins-Domingo, K., & Weiser, S. D. (2019). Food insecurity is associated with poorer mental health and sleep outcomes in young adults. *Journal of Adolescent Health, 65*(6), 805-811.
- Samoggia, A., & Riedel, B. (2020). Assessment of nutrition-focused mobile apps' influence on consumers' healthy food behaviour and nutrition knowledge. *Food Research International, 128*, 108766.

KEEP ACCOUNT YEARLY FOR SUSTAINABLE AUDIT REPORTING (KAYSAR) APPS

Nik Zakiah Nik Mohamed Zain

1Znz Training Specialist Academy, Kota Bharu, Kelantan
coachnikzakiah@gmail.com

Noor Raihani Zainol², Rafiq Sharman Khamis², Mohd Hafis Mohd Fauzi³, Yohan Kurniawan⁴

²Faculty of Entrepreneurship and Business, Universiti Malaysia Kelantan, Kota Bharu, Kelantan

³Center of Infrastructure Development and Management, Universiti Malaysia Kelantan, Bachok, Kelantan

⁴Faculty of Language Studies and Human Development, Universiti Malaysia Kelantan, Bachok, Kelantan
raihani@umk.edu.my; rafiq.sharman@gmail.com; hafis@umk.edu.my; yohan@umk.edu.my

Highlights: Managing small business finances through sound business financial strategies is crucial which can affect the business performance and sustainable of the business financial. To have a good performance in the business, entrepreneurs or small businesses may required a good strategy especially related to the financial performance, such as invoicing, billing, payroll management and etc. Thus, KAYSAR app has been created as the best solution apps in modern SMEs or organisations that affected the overall business performance for the long term. These apps have added value on innovation that make it differ from the other financial software application. The fear and lack of knowledge on financial management always happen to the Start-up Company or small business. Therefore, this app provides the solution for financial health analysis.

Key words: Financial performance, Audit Reporting, Small business, financial health, Payroll management

Introduction

Wave is an online accounting platform exclusively designed for small business owners, freelancers, and consultants. Wave's software provides features including accounting, invoicing, billing, payment tracking, payroll management, finance management, credit card processing, and receipt scanning. This advantage aspires to create future apps where small business owners can manage their finances fearlessly and resulted to the good performance in the business (Cornwall, Vang, & Hartman, 2019; Nitto, 2020). Doing so means more new entrepreneurs, and more thriving small businesses (Ferdiana & Sulisty, 2019). To get to that future, these apps will be the simplest, all-in-one financial management solution small business owners can't live without.

The innovation of these apps design is the added value for the calculation of financial ratio to know the performance of a company or organisations (operational activities). In addition, the company or organisations will get the result or data regarding the performance of a company based on the calculation of financial ratio. Accordingly, those company or organisations able to test their profitability, the financial health situation, and warning sign related to the performance. This innovation apps design will help the entrepreneurs, small business or organisations to sustain for the long term and have a good performance according to their financial analysis. Moreover, these apps designed to allow users to connect several credit cards and bank accounts and allow several profiles to be created for businesses to keep track of expenses and income. This give advantages to the users to create and send professional and branded invoices from the dashboard offered by wave, which is also accessible via a mobile app. The invoicing software can also create recurring invoices and automatic credit card payments for any repeat customers.

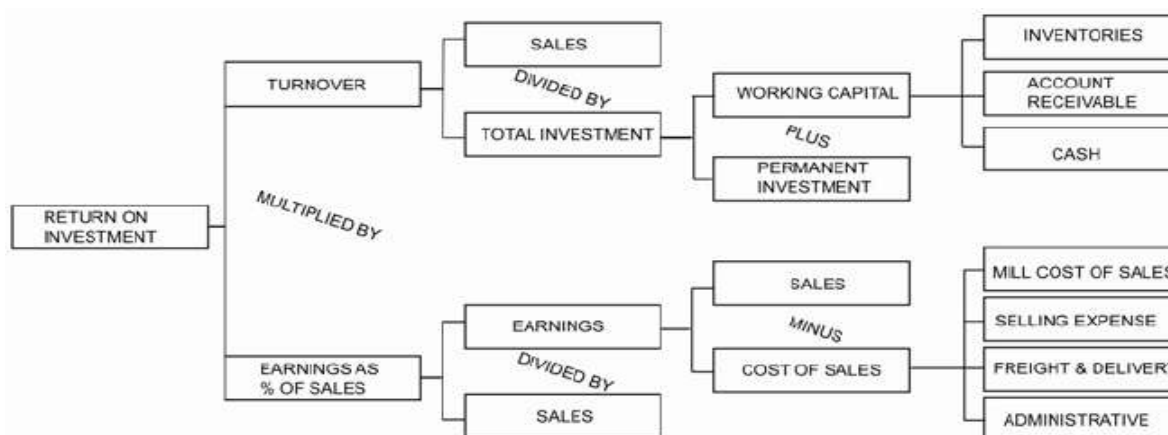

Acknowledgment

We are immensely grateful to Znz training specialist academy teams for sharing their pearls of wisdom with us during the discussion on innovation idea.

References

- Cornwall, J. R., Vang, D. O., & Hartman, J. M. (2019). *Entrepreneurial financial management: An applied approach*. Routledge.
- Ferdiana, R., & Sulisty, S. (2019). The role of information technology usage on startup financial management and taxation. *Procedia Computer Science*, 161, 1308-1315.
- Nitto, M. N. (2020). *Financial Management Strategies for Sustaining Small Entertainment Businesses*.

PROTOTYPE OF BIODEGRADABLE PACKAGING MATERIAL FROM MUSM

Laila Naher

Faculty of Agro-Based Industry, Universiti Malaysia Kelantan, Jeli Campus, 17600 Jeli, Kelantan, Malaysia.
Institute of food security and sustainable agriculture, Universiti Malaysia Kelantan, Jeli Campus, 17600 Jeli, Kelantan, Malaysia.
lailanaher@umk.edu.my

Nor Alifa Mirza¹, Norhafizah Md Zain^{1,2}, Nurhanan Abdul Rahim^{1,3}, Ch'ng, H.Y^{1,4}, M.M.Nor², Siti Maryam Salamah¹ and NurHusna Syahirah¹

¹Faculty of Agro-Based Industry, Universiti Malaysia Kelantan, Jeli Campus, 17600 Jeli, Kelantan, Malaysia.

²Institute of Food Security and Sustainable Agriculture, Universiti Malaysia Kelantan, Jeli Campus, 17600 Jeli, Kelantan, Malaysia.

³Institute of Poverty Research and Management, Universiti Malaysia Kelantan, Bachok Campus, 16300 Bachok Kelantan, Malaysia.

⁴Agro-Techno Park, Jeli Campus, 17600 Jeli, Kelantan, Malaysia.
mizmirza98@gmail.com, maryana.mn@umk.edu.my, norhafizah.mz@umk.edu.my

Highlights: The intend of MUSM packaging materials is to produce alternative packaging which can replace or reduce the vast amount of using polystyrene or synthetic plastic. MUSM is from biobased materials such as plant and mushroom mycelia. The mycelia play a natural binder to make the shape of the fabric according to the mold. The biodegradation processed showed by 18 days, MUSM materials started for degradation in the soil.

Key words: Waste management, polystyrene, environment, pollution, Carboard,

Introduction

Packaging materials are inseparably involved in our daily life. Therefore, for vast production of synthetic packing material especially polystyrene making problem as waste management (Chamas, 2020). Composition of Polystyrene is from petroleum based thus waste of this product released toxic element in the environment affect to human and other biolife (Chamas, 2020). This research was carried out to prepare a prototype of biodegradable packaging tools that can replace the vast amount for polystyrene. As for product development this study used biomass of fungal mycelia and paddy as refer here MUSM to prepare packaging materials. The packaging material design based on mould shape.

It showed fungal mycelia work as natural binder on paddy straw in the mold without using any chemical addition as compare to polystyrene. The mycelia cover the mould within 15-30 days based on mold shape (Table 1). There are three design mold were selected in this experiment which are can holder, bowl, and carboard/flat board. Each of the design has different application in the packaging industry.

- Can Holder: used to store and hold can drink.
- Bowl: used to put and store things like accessory.
- Carboard/Flat board: used to make a more compact structure to create more sturdy materials such as tables and chairs.

In this study, the degradation process was also observed as ensuring the biodegradability. The degradation process was carried out in soil incorporated tray and compare with polystyrene material. The degradation process of the MUSM packaging started to occur on 18 days as material become more brittle, moist, and some decomposer microbial growth can be found on top of the board; therefore, approximately by one 45 days it can completely decompose on soil. On the other hand, there is no change in polystyrene material. In literature showed that plastic, polystyrene packaging products took around 300- 500 years for biological degradation (Chamas, 2020). Besides that during the degradation process of synthetic packaging material of polystyrene released toxic or carcinogenic chemicals in soil, water; hence it has urged to banded polystyrene (Chamas, 2020).

The MUSM packaging material product advantages notice as it is simple to produce, completely biobased, less equipment is needed, cost effective and faster to degrade without leaving any toxic material in the environment.

MUSM production can create entrepreneur because nowadays biodegradable packaging materials demand are increasing in line (Mordor Intelligence, 2020). The awareness of biodegradable packaging materials are increasing in worldwide which showed it has great chance for commercial production in market entry, market share and market size (Mordor Intelligence, 2020).



Figure 1: MUSM Bowl prototype



Figure 1: MUSM cardboard/flat board prototype. Figure 1A shows the mycelium has covered the mold shape; 1B shows that cardboard/flat board from MUSM.

Table 1: Shows the total process information on for the development of different mold shape mushroom packaging materials

No	Sample Design	Initial weight (g)	Time taken to cover mold shape	Expected final weight (g)	Time taken to dry in oven dry	Final weight (g)
1	Can Holder	220.10	25 days	77.04	6 hours	76.89
2	Bowl	260.47	30 days	91.16	7 hours	90.70
3	Desk Corner Protection	76.14	20 days	26.65	5 hours	19.65
4	Flat board (height: 5cm)	207.30	24 days	77.04	12 minutes	67.89

Acknowledgement

We are grateful for the financial support from the grant R/MOF/A0700/004/2020/00724

References

Chamas, A., Moon, H., Zheng, J., Qiu, Y. Tabassum, T., Jang, J.H., Omar, A.M., Scoot, L., & Suh, S. (2020). Degradation Rates of Plastics in the Environment. *CS Sustainable Chem. Eng.*, 8: 3494–3511.

Mordor Intelligence, 2020. MARKET ENTRY - BIODEGRADABLE PLASTIC MARKET IN MALAYSIA: ANALYSIS OF GROWTH, TRENDS AND PROGRESS (2020 – 2025). <https://www.mordorintelligence.com/industry-reports/market-entry-biodegradable-plastic-market-in-malaysia>.access on 17 June 2021.

INTEGRATING ENVIRONMENTAL ELEMENT IN MAXIMIZING BUSINESS PROFIT : AN APPLICATION OF HEDONIC PRICING METHOD

Nur Syafiqah A. Samad

Universiti Malaysia Kelantan, Pengkalan Chepa, Malaysia
nursyafiqah.as@umk.edu.my

Norzalifah Bahari, Siti Fariha Muhamad, Adi Aizat Bin Yajid, Mohd Fathi Bin Abu Yaziz

Universiti Malaysia Kelantan, Pengkalan Chepa, Malaysia
norzalifah.b@umk.edu.my, fariha@umk.edu.my, adiaizat@umk.edu.my, fathi.ay@umk.edu.my

Highlights: Hedonic Pricing Method (HPM) is an innovative design used to determine property price. The property price will be estimated by using a combination of structural, neighbourhood and environmental attributes. Usually, the property price is determined based on structural attributes and neighbourhood attributes. The integration of environmental attributes is a new design that will be recommended to the practitioners. HPM will help the developers identify the best property price even though the environmental attribute was considered. HPM will be aided by Geographical Weighted Regression (GWR) and Geographical Information System (ArcGIS) to identify and visualize the best location, contributing to the maximum profit.

Key words: HPM; GWR; ArcGIS; Business Profit; Environmental Element; Property Price

Introduction

Every company needs to earn a profit to be successful. A profit on a company's income statement indicates that the business is doing well. That profit is essential for the company's continued growth and prosperity. There are a variety of business industries, including the construction industry. Construction is an important sector that contributes significantly to the economic growth of a nation. Despite good for economic growth, it does not mean that environmental elements should be neglected. In Kuala Lumpur, the rapid concrete development causes the significant loss of green space in the urban area (part of environmental element). Thus, Kuala Lumpur has been categorised as below international standard for sustainable city index. The continuous and uncontrolled development trend disturb many fragmentations and create disturbances towards urban dwellers well-being (Ren et al., 2017). This issue arises a major concern among local authority and urban residents (Samad et al., 2020; Johari, Mohd Shafri and Kassim, 2019). It should be overcome thoroughly to ensure the environmental element in a metropolitan area is kept conserve. Meanwhile, the company profit of the construction industry can be growth progressively in a sustainable way. Hence, this study proposes the efficient method known as hedonic pricing method (HPM) to the economic sector to gain maximum profit by considering the environmental attributes.

HPM is an approach to determine the property price based on the combination of the structural attribute, neighbourhood attribute and environmental attributes. The additional of environmental elements is known as innovative design that all entrepreneurs including property developer can implement. Usually, the property price is determined based on structural attributes and neighbourhood attributes. However, using the HPM will help the developers identify the best property price even though the environmental attribute was taken into consideration. It also will help the companies to achieve the maximum profit. This method will be aided by geographically weighted regression (GWR) and ArcGIS to identify and visualise the best location that leads to maximum business profit. Figure 1 showed the output of HPM incorporating GWR and ArcGIS. The finding revealed that the distance between green space (environmental attribute) and property location negatively influenced the house price for the house located in subdistricts of Batu, Setapak, Hulu Kelang, Ampang, and the particular site at sub-districts of KL and KL city centre. The finding informs that property price will be increased if it were developed near to green space. This finding is precious to the developers as HPM aid by GWR and ArcGIS can identify the best location for the future project hence contributing to the company profit.

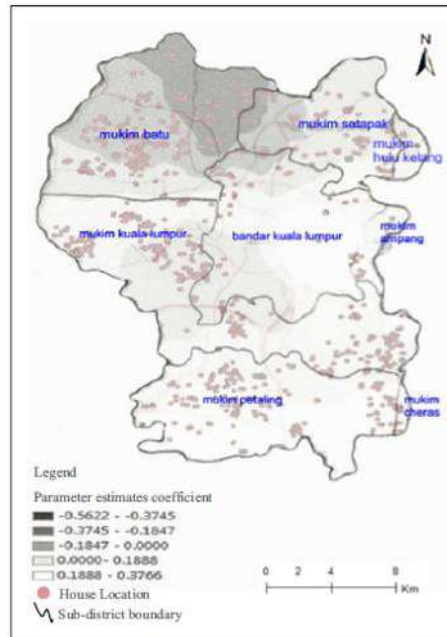

Figure 1: Location Identification based on HPM aid by GWR and ArcGIS

The hedonic price approach is a theory rooted in consumer theory. It is also known as hedonic demand theory or hedonic regression. Wolf (2008) defined hedonic pricing as the observed market price for goods having multiple attributes that can be statistically pulled apart to uncover the value of a particular characteristic for which there may not be an overt indicator of value. The first theoretical justification of this method in measuring a property value was proposed by Freeman III (1979). It can be widely used in all sectors, does not limit the construction industry only, and can be implemented by each sector level. It believes that HPM could provide balance environments, maximize the company profit, and enhance academic knowledge to the community, practitioners, and education sectors.

A novelty of this study is a shift from conventional design into an innovative design that property developers can implement in the urban area to maximize the business profit by considering the environmental attributes. This innovation's impact may help them strategize their future project by maintaining the green space element in the urban area. In addition, HPM able to identify the specific location that they need to develop their project for maximum profit.

The product of this study will be commercialized by enhanced hedonic pricing method applications that suit the need of all entrepreneurs. It is a good start for all practitioners as it was published in the journal of Environmental Science and Pollution Research

Acknowledgement

We are grateful for the Kuala Lumpur City Hall and Valuation and Property Services Department

References

- Johari, M. Y., Mohd Shafri, H. Z., kassim, J.A. (2019). Urban Green Space Degradation: An experience of Kuala Lumpur City. *Environmental Management and Sustainable Development*, 8(1).
- Ren, Y., Qu, Z., Du, Y., Xu, R., Ma, D., Yang, G., Chang, J. (2017). Air Quality and Health Effects of Biogenic Volatile Organic Compounds Emissions from Urban Green Spaces and the Mitigation Strategies. *Environmental Pollution*, 230, 849-861. <https://doi.org/10.1016/j.envpol.2017.06.049>
- Samad, N. S. A., Abdul-Rahim, A. S., Yusof, M. J. M., & Tanaka, K. (2020). Assessing the economic value of urban green spaces in Kuala Lumpur. *Environmental Science and Pollution Research*, 1-24.
- Wolf, K. L. (2008). Metro nature: its functions, benefits, and values. In growing greener cities. *Urban sustainability in the twenty-first century*, 294-315.

AN INTEGRATED ONLINE HUB FOR MUSLIM FRIENDLY HOMESTAY OPERATORS IN MALAYSIA

Nadzirah Mohd Said

Universiti Malaysia Kelantan, Kelantan, Malaysia
nadzirah.ms@umk.edu.my

Derweana Bah Simpong, Hazziyati Hashim, Nur Azimah Othman, Normaizatul Akma Saidi, Wan Farha Wan Zulkiffli

Universiti Malaysia Kelantan, Kelantan, Malaysia
derweanna@umk.edu.my, hazziyati@umk.edu.my, azimah.o@umk.edu.my, akma.s@umk.edu.my, farha@umk.edu.my

Highlights: The homestay is accommodation facilities that provides space or room for rent to the guests. They are four elements of Islamic built environment that will attract tourist to book Muslim friendly homestay which are facility and environment, safety and security, cleanliness and service and privacy (Rashidi, O. et al (2019)). Many operators receive monetary benefits from the Muslim homestay business, thus encouraging more participants in the homestay business. Moreover, the homestay activities give good impact to the Malaysian tourism sector. However, the registered Homestay statistics show that some operators have leave and the number of registered operators has decreased (Nor, S.M (2019)). There are many online hubs in Malaysia such as booking.com, Traveloka and Airbnb but there are no online hubs specifically for Muslim friendly homestay. The introduction of integrated online hub focusing for Muslim homestay operators which combine element of A.I.P.D model will boost the visibility of homestay by promoting using technology advancement. In consequence, it will ensure the sustainability of Muslim friendly homestay business.

Key words: *Muslim friendly homestay, A.I.P.D model, technology advancement, visibility, sustainability*

Content

Muslim Homestay program in Malaysia has giving a large contribution towards the growth of ecotourism and heritage tourism. This is because eco-tourism and heritage tourism was introduced to promote nature, culture, and adventure aspects of Malaysia. The setting up of homestay programs can provide effective mediums for Malaysians to share their lifestyle and culture to outsiders or tourists. Looking at the concept of homestay tourism can give a good impact and benefit especially to the development of the country's tourism sector. Muslims constitute one of the largest local tourist markets in Malaysia. This innovation is a must as there are a lack of online hub that totally focused on Muslim homestay. The online hubs for Muslim friendly homestay are needed and essential for Muslim tourist.

The main purpose of this innovation is to boost the visibility of homestay by promoting using technology advancement. Other than that, this online hub will offer an enjoyable experience in information searching to the guest via integrated online hub of all homestays. The integrated online hub will be used which combining element of A.I.P.D model. A.I.P.D model is a useful guideline to develop an effective website for a company. Therefore, the integrated online hub will be implemented element of attracting, informing, positioning, and delivering in collecting database of SMEs homestay in Malaysia and attracting guest for searching Muslim homestay in Malaysia. The guest will feel fun and exciting when doing information searching for homestay. The innovation of online integrated hub for Muslim friendly homestay will give impacts on improving socio economics of local community. In addition, increasing the visibility of homestay will ensure the sustainability of homestay business. It can be concluded that the innovation will benefit both sides which are Muslim homestay operators and Muslim guests around Malaysia.

References

- Nor, S. B. M. (2019). Challenges Faced By Registered Homestay Operators From The Perspectives Of Selected Stakeholders In Selangor, Malaysia.
- Rashidi, O., Hanie, M. L. N., Saufi, M. D., Zubaidah, A. K. S., Zainul, M. B., & Syakirin, H. Y. H. K. (2015). Muslim-Friendly's Homestay in Malaysia: Issues and Challenges. *Advanced Science Letters*, 21 (6), 1655-1657.

DEVELOPING HOLISTIC PERFORMANCE MEASUREMENT INDEX FOR ISLAMIC BANKS

Siti Fariha Muhamad

Universiti Malaysia Kelantan, Pengkalan Chepa, Kelantan, Malaysia
fariha@umk.edu.my

**Nur Syafiqah A. Samad¹, Adi Aizat Yajid¹, Mohd Rushdan Yasoa¹, Muhamad Nasyat Muhamad Nasir¹,
Fahru Azwa Mohd Zain²**

¹Universiti Malaysia Kelantan, Pengkalan Chepa, Kelantan, Malaysia

²Universiti Sultan Zainal Abidin, Kuala Nerus, Terengganu, Malaysia

syafiqah.as@umk.edu.my, adiaizat@umk.edu.my, rushdan.y@umk.edu.my,
nasyat.mn@umk.edu.my, fahruazwa@gmail.com

Highlights: For several years, performance of Islamic banks has gained the attentions of researchers from academic and industry. Considerable amount of the past literature has focused on the financial performance despite its limitations. This is because many current literatures are focused only on financial performance measurement. To date, there are no in-depth studies on holistic performance measurement which might be applicable to Islamic banks. Hence there exists a need to develop a holistic Islamic bank performance index and thereby to identify the relevant performance indicators. This study aims to formulate holistic performance measure that amalgamates the interests of both shareholders and stakeholders of Islamic banks. The Agency Theory, Stakeholder Theory and *Maqasid Shari'ah* are adopted as the basic frameworks to develop an integrated index for assessment of the overall performance of Islamic bank. The assessment framework is underpinned by performance mandates which are financial performance and principle of *maslahah* of *maqasid Shari'ah*.

Key words: *Islamic bank, performance index, holistic index*

Introduction

Islamic banking industry is the major player of the Islamic finance industry in which it contributes about 69% of the total assets or USD 1,993 billion of the global Islamic finance industry with annual growth of 14%, consisting of 526 Islamic banks, including windows, in 72 countries across the world. Currently, Islamic banks' assets contribute 6% to the total global banking assets (Islamic Development Bank Group & Refinitiv, 2019). It has been growing fast and tremendously in contributing to the economic and social sectors. Past literature has shown that IFIs and Islamic banks were more stable and performed better than conventional banks i.e., Islamic banks were more resilient, efficient and stable during the crisis and post-crisis periods (Diaw, 2015; Hakimi, Rachdi, Mokni, & Hssini, 2018; Parashar & Venkatesh, 2010). Along with the Islamic banking industry's growth, Islamic banks need performance measurement that depicts Islamic banks' true performance in achieving their mission and vision.

Content

The holistic index for measuring the performance of Islamic banks is developed to address the issue of inadequate and insufficient performance measurements that could cater to Islamic banks' unique characteristics and aberrant features that are based on *Shari'ah* principles, as well as the interests of both shareholders and stakeholders. Past research on the performance measurements of Islamic banks is basically still tied to the measurements that have been used in measuring the performance of conventional banks including ratios of profitability, efficiency, earnings, liquidity, credit risk and assets activity. These measures, however, lack and insufficient in capturing the unique philosophies and principles of Islamic banks. The goal of this study is to illustrate the flowchart of research process used in developing the proposed framework of the holistic performance index and to propose the holistic performance index for measuring the performance of Islamic banks index which integrates three components which are *maqasid Shari'ah*, profitability (stakeholder's perspective) and socio and economic objectives (stakeholders' perspective) to satisfy the objective of *Shari'ah* (*Maqasid Shari'ah*), agency theory and stakeholder theory. The processes start with the identification of the key objectives of Islamic banks from the perspectives of Agency Theory, Stakeholder Theory and *Maqasid Shari'ah*. Then, the key objectives of Islamic banks are translated into relevant and measurable sub performance indices within each of the three components by reviewing the extensive literature. Preliminary interviews with experts in Islamic banking industry are next conducted to sieve out the most significant and fundamental performance indicators applicable. The research process then proceeds with the development of operationalization tools comprises of measures, ratios, and data strategy collection. The processes then proceed with the harmonization of the sub performance indices, theories, and operationalization tools before starting with the collection of the required data, analysis of the data.

Finally, the holistic performance measurement index using The Simple Additive Weighting (TSAW) is proposed with the advantages to assist Islamic banks to synergize the strategy to further sustain the performance holistically and provide the shareholders and stakeholders of Islamic banks a summary snapshot to benchmark the performance of Islamic banks in a more holistic manner that suit their objectives. The novelty of this index is it shifts the conventional method of measuring the performance that merely focuses on the profit motive and serves as a new performance measurement for Islamic banks. This holistic index extends the performance measurement index of Islamic banks which are merely focus whether on finance performance measurement or *Maqasid Shari'ah* index only. In term of commercialization, this holistic performance measurement index can be tested against other variables with regard to the study the relationship or association as well as causal effect particularly relating to the performance of Islamic banks as well as collaborative effort with industry partner to further improvise and develop the index into mobile application.

Acknowledgement

This study is part of on-going research grant entitled "A Study of Maqasid Shari'ah as Islamic Banks Performance Measurement in Malaysia" under UMK Fund funded by Universiti Malaysia Kelantan.

References

- Diaw, A., Conseil, A., & Islamique, F. (2014). The global financial crisis and Islamic finance : A review of selected literature. <https://doi.org/10.1108/JIABR-03-2012-0015>
- Hakimi, A., Rachdi, H., Ben Selma Mokni, R., & Hssini, H. (2018a). Do board characteristics affect bank performance? Evidence from the Bahrain Islamic banks. *Journal of Islamic Accounting and Business Research*, 9(2), 251–272. <https://doi.org/10.1108/JIABR-06-2015-0029>
- Islamic Development Bank Group, & Refinitiv. (2019). *Islamic Finance Development Report 2019*.
- Parashar, S. P., & Venkatesh, J. (2010). How did Islamic banks do during global financial crisis? *Banks and Bank Systems*, 5(4), 54–62.

DIAGNOSIS FRAMEWORK OF PERSONAL CASH FLOW STATUS VIA *i-KFC*

Azwan Abdullah

Institute for Poverty Research & Management (InsPeK), Faculty of Entrepreneurship & Business,
Universiti Malaysia Kelantan, Malaysia
azwan.a@umk.edu.my

Mohd Nazri Zakaria¹, Noormariana Mohd Din¹, Mohd Ikhwan Aziz¹, Mohd Zulkifli Muhammad¹, Wan Ahmad Amir Zal Wan Ismail², Tengku Fauzan Tengku Anuar², Nurhanan Abdul Rahman², Hafizi Mat Salleh², Siti Asma Md Rasdi²

¹Faculty of Entrepreneurship & Business, Universiti Malaysia Kelantan, Malaysia,

²Institute for Poverty Research & Management (InsPeK),
Universiti Malaysia Kelantan, Malaysia

mnazri.z@umk.edu.my; mariana.md@umk.edu.my; lkhwan.a@umk.edu.my; zulkifli.m@umk.edu.my,
waamirzal@umk.edu.my, tengku Fauzan@umk.edu.my, nurhanan.ar@umk.edu.my, hafizi.ms@umk.edu.my;
asma.mr@umk.edu.my

Highlights: *i-KFC* (I know financial condition) is a diagnosis framework for individual financial status based on cash flow analysis. Every individual has the right to know the current financial status to ensure the cash flow is in good condition and to mitigate the risk of poverty. Statistics from the Insolvency Department of Malaysia (up to 2021) recorded 293,082 bankruptcy cases. Bankruptcy cases involve various sectors of expenditure and financial management among individuals. This is due to failure in implement personal debt repayment commitments, use of credit cards, housing loans, vehicle loans and many more. This figure is verifying and requires a solution to address cash flow control as well as the equilibrium in individual income and expenditure. Therefore, the *i-KFC* application is built to provide the benefits such as to raise awareness on prudent financial management, reduce the problem of indebtedness, plan expenditure systematically and enable the management of personal financial resources prosperously. The *i-KFC* application was also built to support government policies, among others in the achievement of the Shared Prosperity Vision 2030 (SPV2030) in the fifth strategic thrust, namely Social Welfare. The *i-KFC* also in line with the areas contained in the Sustainable Development Goals (SDG) through the first SDG of "No Poverty". In addition, *i-KFC* aligned with the National Financial Literacy Strategy (2019-2023).

Key words: *Financial literacy, status, cash flow, individual*

Introduction

The financial problems faced by individuals are often linked to various factors. Among the factors is the lack of financial resources to meet daily needs to support family life better. Currently the mass media regularly highlights the problems associated with financial awareness. In accompaniments the case of bankruptcy among individuals is also increasing day by day. Lack of adequate financial resources has led individuals to take shortcuts action by obtaining financial assistance from financial agencies that are not recognized by the government such as "along". This invites various social problems in society. The culture of indebtedness due to lack of knowledge in financial management can be an uncontrollable if the situation not curbed from now on. Therefore, *i-kfc* came up with the introduction of a diagnostic framework to discover the current cash flow status among individuals. This innovation is able to provide awareness to individuals about the knowledge of financial cash flow systematically for sustainable financial well-being.

Description Process of i-KFC

Figure 1: Process flow i-KFC

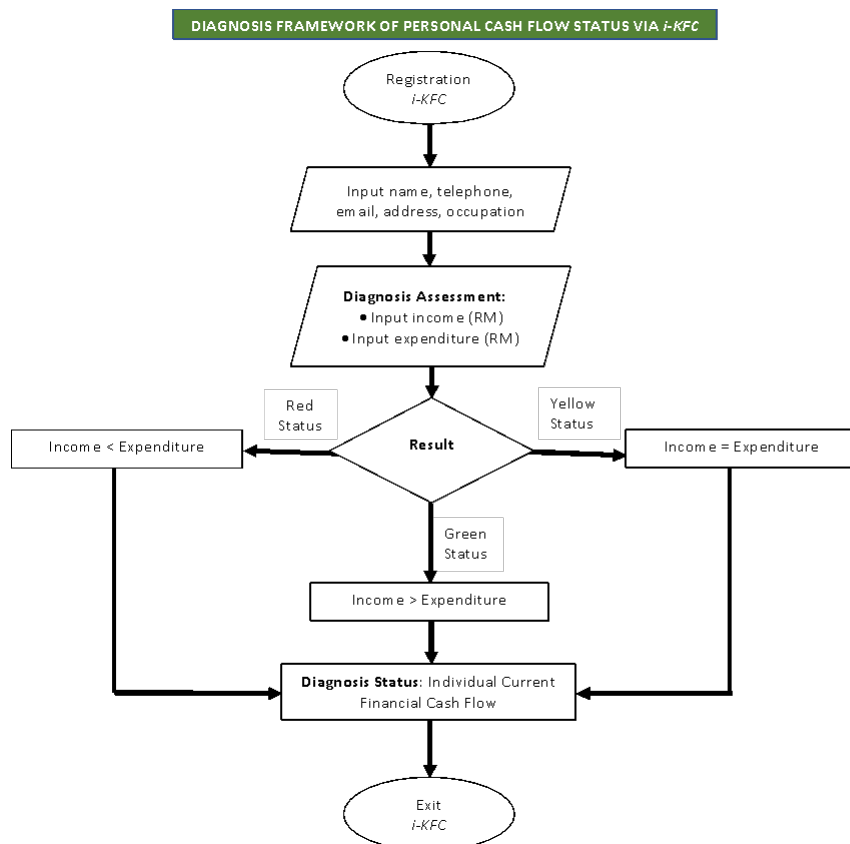

MODUS OPERANDI of i-KFC

Table 1: Modus operating of i-KFC

Steps	Users action	i-KFC processes
Step One (1)	REGISTRATION: Users need to register in the i-KFC application by entering information such as: name, address, telephone, email, occupation.	The information will be stored in the i-KFC database
Step Two (2)	DIAGNOSIS: Users need to go through diagnosis test of cash flow by entering the following information input: • Total income • Total expenditure	Individual cash flow information will be diagnosed by i-KFC. The diagnosis result will issue as follows: • Green Status (Income > Expenses) • Yellow Status (Income = Expenditure) • Red Status (Expenditure > Income) The scores will be stored in i-KFC in scaled cumulative form. Full results will be generated once all processes have been completed.
Step Three (3)	GENERATING RESULTS: Users need to press "ENTER" to generate the overall result.	• The i-KFC also provides brief guides/tips to users on prudent personal financial management based on three (3) coloured status/indicators as follows:

STATUS	GUIDES/TIPS
Green	1) Add savings 2) Increase investment 3) Add risk protection (takaful/insurance) 4) Prepare education financial plan (child/self) 5) Provide saving for Hajj and Umrah 6) Implement property inheritance planning
Yellow	1) Reduce non-essential expenses 2) Avoid buying more than necessary 3) Adopt austerity measures 4) Add risk protection products (takaful/insurance) 5) Do not incur new debt 6) Generate ancillary income 7) Implement debt/liability structuring
Red	1) Reduce non-essential expenses 2) Avoid buying more than necessary 3) Adopt austerity measures 4) Do not incur new debt 5) Termination of not necessary service (examples: pay tv subscriptions, etc.) 6) Generate ancillary income (examples: digital marketing, sewing, GIG economics) 7) Perform additional work to generate income (examples: grab drivers, food deliverers, etc.) 8) Plan expenses based on order of priority 9) Implement debt/liability structuring 10) Adhere to the planned financial budget

Note: These suggestions/tips are only a guide for users to implement financial management more successfully. Subject to cash flow status as well as current financial capabilities and needs.

- End of i-KFC Application

Why I-Kfc Important To Education?

- i. Creating awareness of current financial management among individual.
- ii. Provide knowledge about the importance of prudent financial management.
- iii. Provide wise financial management guidance and tips.
- iv. Avoid the problem of indebtedness.
- v. Eradicating of poverty in society

The Advantages Of I-Kfc Towards Community

- I. Foster a passion for ethical financial management
- II. Encouraging good saving habits in the community
- III. Creating shared prosperity in a more holistic financial management
- IV. Giving efficient meaning in family financial management
- V. Harmonizing financial well-being that is more beneficial for a glorious future
- VI. Support the government's efforts of Shared Prosperity Vision 2030 and the strategy in the SDGs

Commercial Values

- i. Potentially penetrate local and international markets by advertising in the "Play Store" app for everyone's use at an affordable charge.
- ii. Collaborate with AKPK agencies to be used in digital financial education modules for financial counseling guidance.

Acknowledgement

We are grateful to the members of InsPek UMK who were involved in contributing ideas in developing the i-KFC application framework.

References

- E. Thomas Garman, Raymond E. Fogue (2018). A personal application of financial management concepts and tools from Personal Finance. 13th edition, Cengage Learning. Mason, Ohio.
- Jack Alexander (2018) Financial Planning & Analysis and Performance Management. John Wiley & Sons, Inc., Hoboken, New Jersey.
- Thomas J. Stanley, Sarah Stanley Fallaw (2018). The Next Millionaire Next Door: Enduring Strategies for Building Wealth. Guilford, Connecticut: Lyons Press.

B40 SINGLE MOTHER MICRO ENTREPRENEUR EMPOWERMENT PROGRAM THROUGH ONLINE TRAINING AND MONITORING

Mohammad Noorizzuddin Nooh

Universiti Sains Islam Malaysia, Nilai, Negeri Sembilan
noorizzuddin@usim.edu.my

**Jamal Abdul Nassir Bin Shaari, Norhaziah Nawai, Mohd Shukor Harun, Nurul Aini Muhamed, Mahdhir
Abdullah, Zulkifly Mohd Zaki**

Universiti Sains Islam Malaysia, Nilai, Negeri Sembilan
jamal@usim.edu.my, norhaziahn@usim.edu.my, shukorharun@usim.edu.my, nurulaini@usim.edu.my,
mahdhir@usim.edu.my, zulkifly@usim.edu.my

Highlights: The B40 Single Mother Micro Entrepreneur Empowerment Program through Online Training and Monitoring through a grant from Yayasan Hasanah was implemented for 6 months from September 2020 to February 2021. It involved thirty B40 single mother entrepreneurs from various industries. The uniqueness of this program is that in the first 3 months, participants were given an online entrepreneurship course through the Zoom application. In the last 3 months, participants were monitored using an online monitoring system that was built by the team members. At the end of this program, a total of 83% of the participants have shown an increase in sales and it exceeds the KPIs set by Yayasan Hasanah which is 80%.

Key words: *Entrepreneur monitoring system, Single mother, B40, Micro*

Introduction

Business success is depending on the combination of self-awareness and motivation, knowledge, skills, and capital. Abdul Rahman et al. (2014) in their study on economic development among asnaf group emphasis that entrepreneurship model should consist of four main domains: (i) self-development, (ii) business idea development, (iii) transforming idea to business and (iv) business management and expansion. In addition, the usage of an apps to monitor business performance is an innovative way for business reports and assessment (Ab. Rahman et al. 2018). These two studies showed the need for comprehensive entrepreneurship model that start from self-motivation development to the monitoring. The usage of an apps in monitoring the business performance has an advantage rather than the traditional methods, in terms of providing an up-dated record and getting fast responds from advisors. The program is inclusive and involves B40 single mother entrepreneurs from various races in the identified areas. A total of 30 B40 single mother entrepreneurs were identified and screened. Their names were obtained through the Single Mothers Associations, Social Welfare Department, Amanah Ikhtiar Malaysia, TEKUN and also representatives of the local community. They have been screened to ensure that only those who are truly deserving have a place in the program. These single mothers consist of those who have been divorced, widowed or in an abusive relationship.

The members involved in implementing this project have been involved in running entrepreneurship courses to some of this target group in 2018 and 2019 using face to face approach. This time, due to COVID-19, the training and monitoring are conducted entirely online. The "face to face" meeting only took place in 2 sessions; the program description session and the closing session of the program at the end of the sixth month. For both of these "face to face" meeting sessions, social distancing was implemented, and it was conducted in a large hall. The main problem faced by the target group is the lack of knowledge about entrepreneurship while doing business is the source of their daily survival. In addition, they need encouragement and monitoring to ensure that they are on the right track. Among the main weaknesses that have been identified through previous courses is that this group is weak in the aspect of personal and family financial management apart from not having the opportunity to acquire entrepreneurial knowledge in a guided, systematic, and structured manner. The program has filled the void by providing them with much-needed knowledge starting from how to manage family and personal finances, ethics in business, identifying the main functions in business, online business and several other courses that are felt necessary for them to continue living as an entrepreneur.

This program is an inclusive program involving all races. The first group of 30 B40 Single Mother Micro Entrepreneurs received Internet data for 6 months for the purpose of online education and monitoring. Participants were assisted through online Zoom classes as well as previously recorded videos as teaching material. In addition, participants were exposed to the entrepreneur monitoring application by submitting daily/weekly reports in the form of problems encountered as well as their sales cash flow. All this has been monitored by USIM Tjjarah Holdings Sdn Bhd (UTHSB) and instructors through the application. Through this application, any feedback and response from UTHSB can be implemented quickly and periodically.

During the first day of the program, participants were taught on how to use the online learning system. When the program began in the first week, participants attended classes virtually and interacted virtually with the instructors involved until the end of the sixth month. Since all participants are B40 entrepreneurs, they need to fill in daily reports in the system. This is also where the main monitoring from the teaching staff to ensure that participants do not wander away from the main objectives.

Apart from the online learning portal, participants were exposed to the use of a monitoring system that we have built where participants have filled out daily reports and have been monitored in groups by the instructors involved. Every day, participants must fill out a cash flow report of their business. Through this system, the instructors will always know the development of the participants and if deemed necessary, the instructors can intervene to help the participants involved. These daily cash flow reports can be printed by the instructor on a daily, monthly, and annual basis. In addition, 24-hour interaction can be implemented by the instructor by sending the latest updates on learning notes. In addition, there are additional modules in this application where instructors can provide feedback quickly and systematically.

This is very different from the norm of regular entrepreneurship courses where feedback takes a long time because they must wait for working hours for any feedback not only from participants but also from the teaching staff. Any latest developments have been constantly updated through the application and participants have received information in 'real-time'. The teaching staff consists of those who have experience working with Single Mother Entrepreneurs in terms of providing financial motivation and entrepreneurship courses. They also consist of those who have received formal recognition through certificates of their involvement in volunteerism as well as entrepreneurship. Instructors have also received ToT certificates from agencies such as Pembangunan Sumber Manusia Berhad, AKPK, MDEC and Alibaba Business School.

Conclusion

The program has achieved the KPIs set by Yayasan Hasanah by demonstrating an increase in sales of over 83% of the total participants. Among the reasons for this success is the existence of a monitoring system that has been built specifically for this purpose.

Acknowledgement

The consulting group would like to thank Yayasan Hasanah under Khazanah Malaysia for providing a grant worth RM97,000.00 for the purpose of developing B40 single mother entrepreneurs.

References

- Ab. Rahman, A., Ali Basah, M. Y., Nooh, M. N., Abdullah, M., Mohd Fauzi, A. A., & Abu Bakar, M. F. (2018). Program Usahawan Bagi Memperkasakan Ekonomi Golongan Asnaf: Pemantauan daripada Aplikasi Myema. *Journal of Fatwa Management and Research*, 7(1), 57-74. <https://doi.org/10.33102/jfatwa.vol7no1.59>
- Ab. Rahman, A., Ali Basah, M. Y., Nooh, M. N., Abdullah, M., Mohd Fauzi, A. A., & Abu Bakar, M. F. (2014). *Memformulasi Model Produktif Pembangunan Program Usahawan bagi Memperkasakan Ekonomi Golongan Asnaf. PERKEM*. https://www.ukm.my/fep/perkem/pdf/perkem2014/PERKEM_2014_2A1.pdf

FRESHGO CLOUD DATA WAREHOUSE CONCEPT WITH MUTUALISTIC ECOSYSTEM

Intan Nurrachmi

Universitas Islam Bandung, Bandung, Indonesia
intannurrachmi@unisba.ac.id

Anthon Budyana¹, Hardyansyaah¹, Rizky Alamsyah Nurdianto²

¹FreshGo, Bandung, Indonesia

²Universitas Islam Bandung, Bandung, Indonesia

anthon789@gmail.com, hardyansyaah@gmail.com, rizkyalamsyah125@gmail.com

Highlights: FreshGo Indonesia is a Digital Farm Supplies and Online Groceries business and entrepreneurship company that connects high-quality suppliers with customer needs. It provides a variety of healthy, fresh, halal daily essential needs. The company prioritizes customer satisfaction, particularly in terms of selecting the quality of ordered goods, with good quality control and delivering customer orders according to the principle of adaptation to the new normal. This research aims to examine the FreshGo cloud data warehouse concept with mutualistic ecosystem. The result of this research is that FreshGo opens partnership opportunities which provide advantages through supply chain management, charity, and productivity.

Key words: *business, FreshGo, cloud data warehouse, online*

Introduction

Indonesia is an agricultural nation in which most of the population work in the agricultural field. This is a promising prospect since fertile soil and lands are the supporting factors. The agricultural sector plays an important role in improving the economy and meeting food needs. (Sayifullah, 2018). Especially in the current times of COVID-19 pandemic, where on-site transactions are restricted. Public movement restrictions by the government become a problem for the distribution of agricultural products to the consumers. Therefore, it slows down the pace of the national economy. This indirectly changes the economic system and consumer's behaviour to a different direction from before which is called the new normal (Intan Nurrachmi, 2021). Distribution and online shopping, which is online ordering, use delivery service to the destination.

Hence, FreshGo Indonesia is here to answer such problems. It is a Digital Farm Supplies and Online Groceries company that connects high-quality suppliers with customer needs. Customer satisfaction is its priority, particularly in terms of selecting the quality of ordered goods, with good quality control with health protocols standard. FreshGo provides a variety of healthy, fresh, and halal daily essential needs such as vegetables, fruits, seafood, meat, groceries, and processed products. (<https://freshgo.id>, 2021)

This research aims to examine the FreshGo cloud data warehouse concept with mutualistic ecosystem. In this case, the company invites partnership in the supply of goods as well as the distribution with various advantages and profits, and also the best service guarantee.

Content

FreshGo consists of 2 words, Fresh & Go means presenting a concept of people's FRESH daily needs and GO means they can be ordered INSTANTLY or get delivered on the same day. FreshGo Indonesia was founded on July 1, 2020. There are several things about the establishment of the company:

1. Supply Chain Management
Breaking the overly long chain from the farmers to the consumers that caused the price to be expensive but not very profitable for the farmers. Therefore, Freshgo as a startup in food supplies chain management field helps everybody to get fresh daily needs.
2. Charity
This company invites the entire ecosystem to help each other in goodness, particularly in terms of the welfare of the farmers. Every time a customer purchases at freshgo.id, the company will take notes and set aside 2.5% of the profit.
3. Healthy, Fresh, and Halal Food
The COVID-19 pandemic has caused social and economy impacts on society. While maintaining social distancing, public need healthy, fresh, and halal basic needs.
4. Stay at Home
The company provides delivery service that delivers healthy food to customers at home.

5. Productivity

By directly delivering basic needs to the consumers, consumers can wisely use their time and energy for more important things.

FreshGo Indonesia designs online business models, one of the featured one is Freshgo Cloud Data Warehouse. By definition, cloud stands for cloud computing, briefly defined as a digital storage unit that can store all files (Rumetna, 2018). Where as the warehouse is a temporary storage and an inventory retrieval point to support operational activities for the next operation process, or to distribution locations, or to final consumers. (Martono, 2018). Warehouse can be described as part of a company's logistic system that serves to store products and provide information regarding the status and condition of the materials/inventory stored in the warehouse, so the information is always up-to-date and easily accessible by anyone whom authorized. (Zaroni, 2017).

Accordingly, FreshGo cloud data warehouse with ERP (Enterprise Resources Planning) is a goods storage facility or a warehouse that is provided by the company that serves to store products and also to provide information regarding the status and condition of the materials or inventory that can be accessed online at any time. In addition, consumers can establish partnership by shopping as well as investing with various profits according to consumer's investment classification. Thus, digital channels are optimized for customer engagement through daily orders and partnership management with the marketing system for 4 types of business partners, which are: FreshGo Direct, FreshGo Ultimate, FreshGo Premium, and FreshGo Stockist. To join the program is very easy. Register online at freshgo.id, verify via e-mail, then customers will get registration code to enter the system.

By the presence of this company, there are surely several parties that benefit mutually (Mutualistic Ecosystem), namely farmers, main markets, agencies, partners (couriers), integrated businesses, as well as micro, small, medium enterprises, and et cetera. Currently, there are 12 Cloud Warehouse Agents with more than 50 suppliers.

Figure 1: Distribution Plan

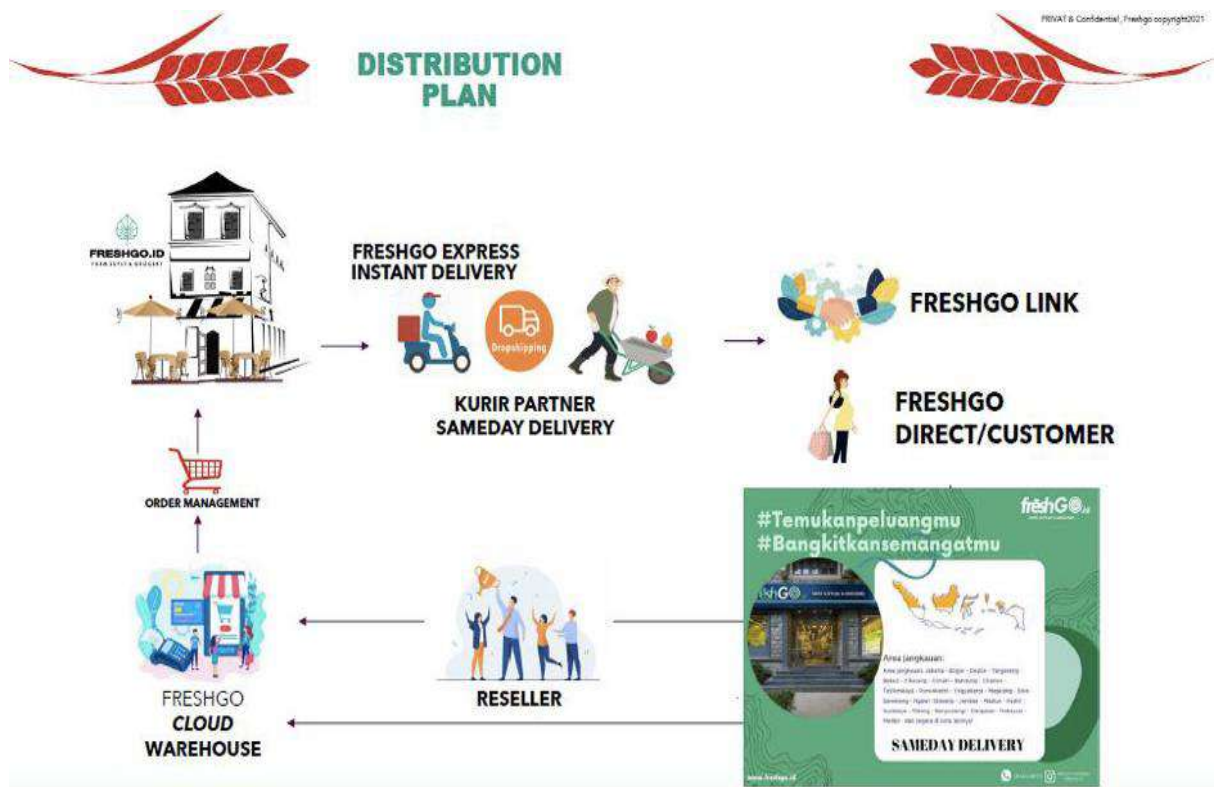

In addition, there are several strategies to make promotions on various social medias and increase the frequency and the speed of products delivery through FreshGo Express and courier partners, so that the consumers will be satisfied with such punctuality.

Conclusion

FreshGo Indonesia is a Digital Farm Supplies and Online Groceries business company which connects high-quality suppliers with customer needs. It provides a variety of healthy, fresh, halal daily essential needs and opens partnership opportunities which provide advantages through supply chain management, charity, and productivity with mutualistic ecosystem. The partnership types are FreshGo Direct, FreshGo Ultimate, FreshGo Premium, and FreshGo Stockist. FreshGo Indonesia has Cloud Data Warehouse concept with the support of information technology based on Enterprise Resource Planning (ERP), it markets through digital and social media optimization, and determines the right market segmentation by maintaining quality and guaranteeing order conformity.

References

- <https://freshgo.id>. (2021). *Company Profile Freshgo Indonesia*. Bandung: <https://freshgo.id>.
- Innan Nurrahmi, S. U. (2021). Consumer Behavior and Patterns During the Covid-19 Pandemic in Indonesia. *Advances in Social Science, Education and Humanities Research*, volume 536, 23-27.
- Martono, R. V. (2018). *Manajemen Logistik*. Jakarta: Gramedia Pustaka Utama. hal 34.
- Rumetna, M. S. (2018). Pemanfaatan Cloud Computing Pada Dunia Bisnis: Studi Literatur. *Jurnal Teknologi Informasi dan Ilmu Komputer (JTIIK)* Vol.5, No.3, DOI:10.25126/jtiik.201853595, 305-314.
- Sayifullah, E. (2018). Pengaruh Tenaga Kerja Sektor Pertanian Dan Pengeluaran Pemerintah Sektor Pertanian Terhadap Produk Domestik Bruto Sektor Pertanian Di Indonesia. *Jurnal Ekonomi-Qu (Jurnal Ilmu Ekonomi)* Vol. 8, No. 1, 66-81.
- Zaroni. (2017). *Logistics & Supply Chain*. Jakarta: Prasetya Mulya Publishing. hal 101.

HUB FOR SOCIAL ENTREPRENEURSHIP (HUBSOE): CATALYSING IMPACTFUL INNOVATIVE SOLUTION TO SOCIAL AND ENVIRONMENTAL SUSTAINABILITY

Noor Raihani Zainol

Faculty of Entrepreneurship and Business, Universiti Malaysia Kelantan, Pengkalan Chepa, Kelantan, Malaysia,
raihani@umk.edu.my

Anis Amira Ab Rahman, Nurul Izyan Mat Daud, Zul Karami Che Musa, Nur Ain Ayunni Sabri, Mohd Zulkifli Muhammad, Roselina Ahmad Saufi, Fatin Najihah Nik Muhammad

Faculty of Entrepreneurship and Business, Universiti Malaysia Kelantan, Pengkalan Chepa, Kelantan, Malaysia,
anisamira@umk.edu.my, izyan.md@umk.edu.my, zul@umk.edu.my, ayunni.s@umk.edu.my, zulkifli.m@umk.edu.my,
roselina@umk.edu.my, a20d058f@siswa.umk.edu.my

Highlights: Social entrepreneurship successfully demonstrates alternative working models to face the critical challenges to our planet, our societies and our economies. As the urgency to meet shared challenges and common goals of the SDGs by 2030 intensifies, innovative collaboration has an important catalytic role to play in highlighting and integrating what has worked effectively with sustainable solutions. Many practitioners are still unclear how this growing jumble of techniques fits together or with existing systems, which can fill in a few missing gaps, while simultaneously ignoring other elements equally essential to success. Thus, to fill these gaps, HubSoE has been developed as an innovative solution to social and environmental sustainability. This HubSoE system is different from the available system due to the content and value of the system. Furthermore, this system created an ecosystem for digital collaborative between social enterprise, supplier, various industries in different field, and government agencies with specific details information that can help target beneficiaries including B40 community, asnaf, disabled, disadvantage, and etc. In other words, to establish a system for guaranteeing community sustainability in a social enterprise project, identify products, services and skills that may assist the community in a social enterprise project, then identify the system's process that can operate successfully (mix and match). HubSoE are critical tools for bringing together a diverse set of talents, competencies and impact projects on a single platform. As a result, this platform will be utilised as a guideline or source of information for the government, investors, academics, researchers, and social enterprises to assure the project's long-term viability and dependability.

Key words: *HubSoE, Social Entrepreneurship, Social Sustainability, Environmental Sustainability, Impactful, Innovative Solution, B40 Community*

Introduction

Presently, in the quest for answers to serious social and environmental problems, social entrepreneurship is increasingly widely seen as a critical component (Muñoz, & Kimmitt, 2019). Efforts to provide socioeconomic wellbeing or meet social needs are frequently connected with innovative platform (Macke, Sarate, Domenighini, & Da Silva, 2018). Social entrepreneurship is increasingly being the topic of in-depth research and analysis, which reflects well for its fast growth (Rawhouser, Cummings, & Newbert, 2019). Accordingly, this HubSoE is to present an innovative platform for impactful innovative solution to social and environmental sustainability. This important function aids in the identification of talents and abilities gained by target beneficiaries groups that may be promoted or commercialised as a means of generating income. The community has the option of increasing their income or earning more money to support their families. Apart from that, the figure contained information about the intended recipient and the parties involved in assisting them with the social entrepreneurship initiative. They also can register as social enterprise to increase the number of social enterprise in our countries, as well as reduce the social problems especially focus on Sustainable Development Goals (SDGs) (Maseno & Wanyoike, 2020). HubSoE provides solutions to social issues that assist the government, non-governmental organisations, and other parties in determining next steps. These activities result in the greatest levels of collaboration or joint ventures, including all parties in community development, while also boosting the national economy and society (Morris, Santos, & Kuratko, 2020).

Furthermore, build a system to enter all data based on target beneficiaries which involves these several things that is, help outsiders or who want to get involved in social entrepreneurship projects. For example, the group wants to develop educational projects among asnaf children. Therefore, they can refer to this system and website where the purpose of this platform is made to be adapted to match with social entrepreneurship projects. When the asnaf and b40 have been given knowledge, encouragement and education to become social entrepreneurs and they are able to stand on their own, then they will be helped to form a social entrepreneurship. They will be given the right channels, with whom they need to meet, to whom they want to go, and the site seems to be a consultation with them. On the other hand, the suppliers and other parties are also involved where they want to know the detail related to the group of b40 and asnaf community, they can refer in this platform.

For instance, any supplier provides a project to embroider clothes, sew various types of clothes and so on, then if they only want to take the asnaf community to work with them to help their survival, so the supplier can refer in the website about what expertise the asnaf have and can do.

1. HubSoE Value Added for B40 Community

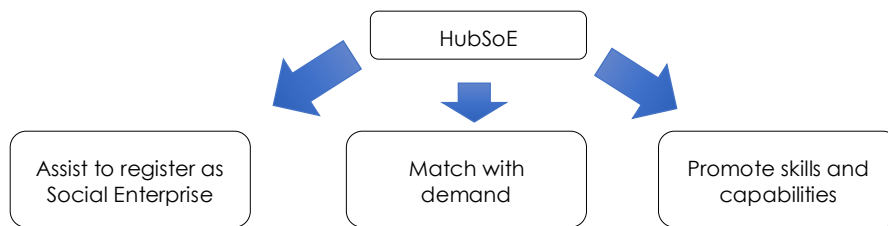

Figure 1: HubSoE Value Added

2. HubSoE: A Platform for Symbiosis Concept for B40 Community

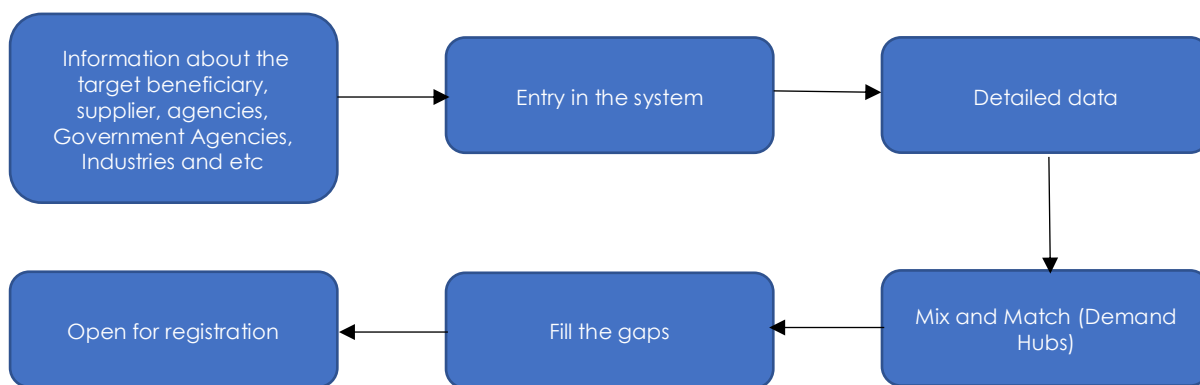

Figure 2: The Process of HubSoE System

Figure 2 shows the included input from a variety of sources. The flow chart can assist social enterprises, suppliers, and other parties in assisting the target beneficiaries as they go through the social entrepreneurship initiative. Next, because these concerns and problems are still new and need to be explored in more depth before the study can progress, this type of website is highly beneficial and essential to social entrepreneurship. Following that, this data will allow social enterprises and other collaborative partner to learn about the background, lifestyle, and activities in order to assist them in becoming acquainted with the social entrepreneurship programme and project, and give the solution to the social and environmental sustainability.

Acknowledgement

We are grateful for the continuous support, encouragement, and insightful comments and discussion from the UMK-Prototype members.

References

Macke, J., Sarate, J. A. R., Domeneghini, J., & da Silva, K. A. (2018). Where do we go from now? Research framework for social entrepreneurship. *Journal of Cleaner Production*, 183, 677-685.

Morris, M. H., Santos, S. C., & Kuratko, D. F. (2020). The great divides in social entrepreneurship and where they lead us. *Small business economics*, 1-18.

Maseno, M., & Wanyoike, C. (2020). Social entrepreneurship as mechanisms for social transformation and social impact in East Africa an exploratory case study perspective. *Journal of Social Entrepreneurship*, 1-26.

Muñoz, P., & Kimmitt, J. (2019). Social mission as competitive advantage: A configurational analysis of the strategic conditions of social entrepreneurship. *Journal of Business Research*, 101, 854-861.

Rawhouser, H., Cummings, M., & Newbert, S. L. (2019). Social impact measurement: Current approaches and future directions for social entrepreneurship research. *Entrepreneurship Theory and Practice*, 43(1), 82-115.

G-ROLES: FBS MODEL

Nurul Ashykin Abd Aziz

Faculty of Entrepreneurship and Business, Universiti Malaysia Kelantan
ashykin.a@umk.edu.my

Nik Syuhailah Nik Hussin¹, Zuraimi Abdul Aziz¹, Hasif Rafidee Hasbollah², Mohd Hizam Hanafiah³

¹Faculty of Entrepreneurship and Business, Universiti Malaysia Kelantan

²Faculty of Hospitality, Tourism and Wellness, Universiti Malaysia Kelantan

³Faculty of Economics and Management, Universiti Kebangsaan Malaysia

niksyuhailah@umk.edu.my, zuraimi@umk.edu.my, rafidee@umk.edu.my, mhhh@ukm.edu.my

Highlights: Our innovation is a form of business survival model known as G-Roles: FBS (Government Roles: Franchise Business Survival) Model. This innovation helps promoting governments' initiatives and role in the business survival of franchise companies during the pandemic crisis. The model was developed by integrating several theories in clarifying the context; Institutional Theory; Network Theory; Resources Dependency Theory; and Resource Scarcity Theory. As such, this model will assist government agencies, franchisees, and franchisors in developing policies, plans, and initiatives. Its commercial value will be based on the services provided in the business consultation, guidance, and training program, which aims to implement the managerial intervention in planning strategies for business survival in crises.

Key words: *franchising, business survival, government role, institutional role*

Introduction

The franchise has gone through an era of company expansion and continues to grow (Mahmood, 2015). As a platform for company distribution, franchising has significantly developed in the modern era (Hoffman & Preble 2003; Pery & Rajiv 1999). Franchising is vital for economic development since it creates new jobs, develops new business start-ups, and raises people's living standards, as shown by Shumba, Zindiye, and Donga (2017). Conclusively, franchising is a commercial and social model that affects the economy and society, notably in job creation, economic modernization, and franchise entrepreneurs' development (Alon, 2004; Naatu & Alon, 2019). Many scholars agreed that a franchise business directly impacts these three factors (Elango, 2019; Naatu & Alon, 2019).

After the global pandemic, the world was in shock, which started in China in December 2019 and spread. In addition, 216 nations were infected, 39,278,910 persons sick, 1,104,411 deaths, and 29,433,171 patients recovered (Worldometers, 2020). The pandemic also has a substantial influence on businesses and the economy. According to Alves et al. (2020), small firms, even during a crisis, remain largely unknown regarding how they survive.

Furthermore, the ongoing pandemic closed down numerous well-known brands across many industries, contributing to their bankruptcy. Everyone was told to stay at home while the lockdown was in effect (Tucker, 2020). Conversely, the pandemic has dramatically affected most countries' economies but notably more critical in emerging economies. Heterogeneous economy, yet has general characteristics, such as inadequate institutions and legal provisions, lower economic growth levels, and higher financial and social risk (Hevia & Neumeyer, 2020; Surico & Galeotti, 2020).

Developed and developing countries have also been affected by this pandemic issue, and this is worrisome. As a result of this crisis, investors are pulling out of countries that are considered high risk. For countries with an export-oriented economy, like China, Mexico, and Brazil, falling the demands are challenging. Also, tourism, an important source of income for many emerging and developing countries, is defunct (Fariza, 2020; Stiglitz, 2020). The services and retail businesses are additionally affected by the pandemic. Some retail industries, like apparel and construction, were also hit. Undeniable, the franchise industry is affected as well. It incorporates company operations and franchise integrity. This crisis will additionally strain dynamic franchisor-franchisee relationships.

Content

This model has been developed by employing data-based links to the multiple theories; Institutional Theory; Network Theory; Resource Dependence Theory; and Resource Shortage Theory. Due to the developing pandemic issue, franchise businesses have encountered major operational, financial, and liquidity challenges. In addition, full inventory will be damaged or outdated, leaving franchise businesses unable to operate during a pandemic crisis. The franchise agreement will be affected because of this involving the franchisor and franchisee.

In this situation, government agencies assisted franchisor and franchisee in starting their businesses from the ground up, providing financial aid, training, and advice along the way. The franchisors requested government support in any form that required them to make demands or advise authorities that were planning initiatives to assist them. As a result, it's critical to comprehend the aspects that affect business sustainability and the impact of the pandemic issue, and the government's involvement in aiding afflicted franchisors and franchisees.

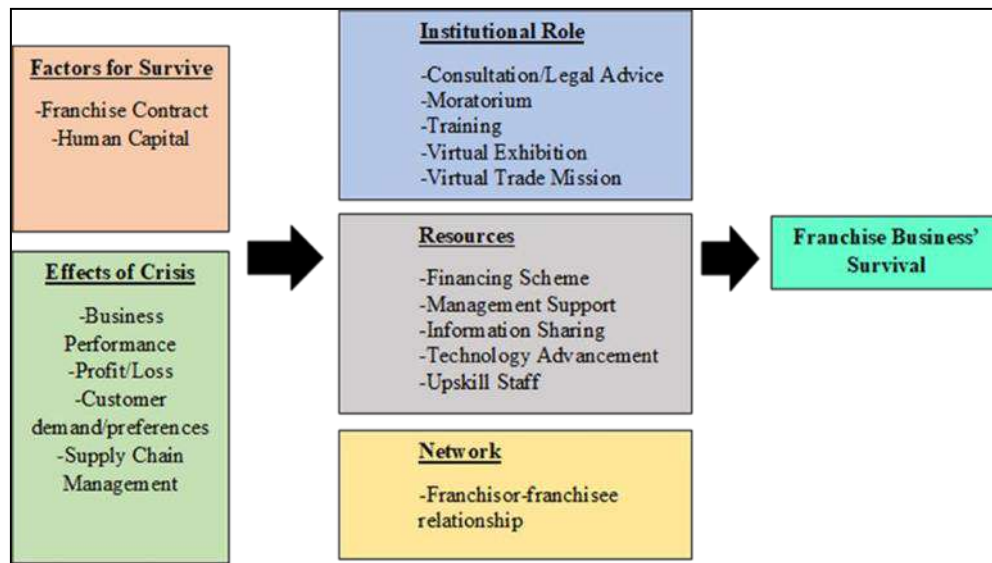

Diagram 1: G-Roles: FBS Model

The innovators developed a new model namely G-Roles: FBS Model by using qualitative approaches that covers three areas: (i) factors for survival; (ii) effects of the pandemic crisis; and (iii) the government's role in assisting the franchise industry affected by pandemic crisis.

According to Institutional Theory, this study determined the consistency of government assistance provided by support agencies in assisting and guiding franchise businesses through the development process. A franchise is made up of experiences, skills, attitudes, ideas, and values (Sanfelix, 2018). This dimension includes the training, information, and abilities that the franchisor brings to the relationship. At the same time, the franchisee pays with past training, local market expertise, process innovation, royalties, and entrance fees. In line with Network Theory, it argues about a firm's relationships with others and how these relationships affect the firm's performance and outcomes (Thorelli, 1986).

According to Pfeffer (1972), Resource Dependence Theory was founded on the assumption that an organization's ability to collect essential resources from the outside world is critical to its survival. Firms typically adapt to resource constraints by establishing inter-organizational arrangements such as inter-organizational systems (Drees & Heugens, 2013; Wicker et al., 2013). For the most part, Resource Dependency Theory examines how resources are required in specific ways and how the connection of uncertainty leads to power imbalances and asymmetric dependency between two parties.

This new model was developed by contributing to an in-depth understanding of the correlation between factors, impact and the role of government on the survival of the franchise business during a pandemic crisis. The integration of some well-known theories in franchising studies such as Institutional Theory, Network Theory, Resources Dependency Theory, and Resource Scarcity Theory contributed to the production of a new model that emphasized the importance of government agencies in the sustainability of the franchise business. G-Roles: FBS This model helps relevant parties recognize the factors determining the strategies and initiatives to help franchise entrepreneurs involved in pandemic crises.

In term of advantages from our innovation, G-Roles: FBS Model was developed through in-depth interview with industrial experts, and this contributes to a new and deeper understanding of the role played by the agencies involved with the development of the franchise industry. Indeed, G-Roles: The FBS Model can be a reference for governments to develop new policies or improve existing policies that can benefit franchise players, especially when they are struggling with pandemic crises that affect their ability in business survival. Also, this model also beneficial for future researchers where they could employ quantitative methodology to test the applicability of the G-Roles: FBS Model.

For the commercialization, the G-Roles: FBS Model has the potential to be commercialized by producing modules that include an in-depth explanation of this model, namely: (i) the factors that influence the survival of the franchise business during the crisis; (ii) the impact of the crisis on the survival of the franchise business; and (iii) the role of government in assisting the survival of the franchise business. Moreover, modules also can be developed in future based on G-Roles: FBS This model can be used as a guide by relevant parties related to the franchise industry.

Acknowledgement

We are grateful to have developed this model due to ideas, knowledge, and cooperation of all members. The findings of this study are based on our grant which is funded from the UMK-FUND grant under Universiti Malaysia Kelantan. May it be beneficial to all.

References

- Global Franchising and Development in Emerging and Transitioning Markets. *Journal of Micromarketing*, 24(2), 156–167. Drees, J., & Heugens, P.
- P. M. A. (2013). Synthesizing and Extending Resource Dependence Theory: A Meta-Analysis. *Journal of Management*, 39(6), 1666–1698.
- Elango, B. (2019). A Bibliometric Analysis of Franchising Research (1988-2017). *The Journal of Entrepreneurship*, 28(2), 223–249.
- Fariza, I. (2020, May 4). Crisis In Emerging Countries, The Blind Angle Of The Coronavirus Pandemic.. Retrieved from <https://brasil.elpais.com/economia/2020-05-04/crise-nos-emergentes-o-angulo-cego-da-criredo-coronavirus.htm>
- Hevia, C., & Neumeyer, P. A. (2020, April 21). A perfect storm: COVID-19 in emerging economies. Retrieved from <https://voxeu.org/article/perfect-storm-covid-19-emerging-economies>
- Hoffman, R. C., & Preble, J. F. (2003). Convert to Compete: Competitive Advantage through Conversion Franchising. *Journal of Small Business Management*, 41(2), 187–204.
- Mahmood, A. K. (2015). *Restaurant Franchising Concepts, Regulations and Practices* (3rd ed.). Toronto, New Jersey: Apple Academic Press and CRC Press Taylor & Francis Group.
- Naatu, F., & Alon, I. (2019). Social Franchising: A Bibliometric and Theoretical Review. *Journal of Promotion Management*, 25(5), 738–764.
- Pfeffer, J. (1972). Merger as A Response to Organizational Interdependence. *Administrative Science Quarterly*, 17, 382–394.
- Sanfelix, G. N. (2018). New Challenges in Franchisor-Franchisee Relationship. An Analysis from Agency Theory Perspective. *Management Notebooks*, 18(1), 85–101.
- Shumba, K., Zindiye, S., & Donga, G. (2017). Challenges faced by franchise entrepreneurs operating in a volatile business environment: a case of the fast food industry in Harare, Zimbabwe. *Problems and Perspectives in Management*
- Stiglitz, J. E. (2020, April 6). Internationalizing the crisis. Retrieved from <https://www.project-syndicate.org/commentary/covid19-impact-on-developing-emerging-economies-by-joseph-e-stiglitz2020-04>
- Surico, P., & Galeotti, A. (2020, March). The economics of a pandemic: The case of COVID-19. Presented at the International Council for Small Business, London Business School. Retrieved from <https://icsb.org/theeconomicsofapandemic/> Thorelli, H. B. (1986). Networks: Between Markets and Hierarchies. *Strategic Management Journal*, 7(1), 37–51.
- Wicker, P., Vos, S., Scheerder, J., & Breuer, C. (2013). The Link Between Resource Problems and Interorganisational Relationships: A Quantitative Study of Western European Sport Clubs. *Managing Leisure*, 18(1), 31–45
- Worldometers (2020) Covid-19 Coronavirus Pandemic. Accessed on October 16th, 2020, from https://www.worldometers.info/coronavirus/?utm_campaign=homeAdUOA?Si

MAGIC WOODEN FOLDING TABLE

Siti Hajar Binti Mud Ariff

Politeknik Kota Bharu, Kelantan, Malaysia
hajarariff@pkb.edu.my

Maizatul Aisya Binti Ab Halim, Nur Fatin Syafiqah Binti Mazani, Nur Anis Ayunie Binti Kamarudin, Nur Anisah Binti Idzuwan

Politeknik Kota Bharu, Kelantan, Malaysia
maizatulaisya89@gmail.com, syafiqahmazani20@gmail.com, ayunikamarudin080800@gmail.com,
niesah7722@gmail.com

Highlights: Malaysian need to comply with the Movement Control Order announced by the government. The education sector also had to be closed, including private and public Higher Education Institutions (IPT). Magic Wooden Folding Table is an innovation designed to the student as one of online learning equipment. It is safe to use and can help students to study in a comfortable environment during online classes because this mobile table provides space to place laptops, notes, mouse, stationary and even drinking water.

Key words: *Online Class, Magic Wooden Folding Table.*

Introduction

Malaysian needs to pay attention to the Movement Control Order (MCO) starting on 18 March 2020. This Movement Control Order uses all aspects including banning their citizens from leaving the country. Economic sectors in both government and private also need to be closed. Other sectors also affected such as education sector, including private and public Higher Education Institutions (IPT). Therefore, all students are encouraged to do online learning classes. Some of the students facing a problems as there is no suitable place, tools and equipment to do their online learning class. This folding table was inspired from folding furniture with multiple functions and become a Magic Wooden Folding Table. In addition, this Magic Wooden Folding Table is created for students so they can have their teaching and learning at their comfort. Furthermore, this folding table provides spaces for laptops, notes, mouse, stationary and even a place for a cup. This can help students to practice their online study sessions. This Magic Wooden Folding Table is made from high quality, Merawan wood. Moreover, this folding table was coming in mini-sized and easier for students to bring it anywhere. This table is created to reduce the back pain, neck pain and eye strain when students can sit ergonomically by using this table. In conclusion, this table is safe to use and can help students to study in a situation that uses the current compilation of online classes.

Product Development

This Magic Wooden Folding Table is designed with a unique shape, where it is possible to write in any sitting position as this table is adjustable. It allows students to lower it all the way down or raise it to its maximum height and to turn it into a convenient table for the users. This folding table also ergonomics and comfortable since it's provides a space for students to put their laptop as well as taking notes during online learning sessions. Besides, there are several compartment for student to put their belonging such as mouse, writing equipment, and drinking bottle. By using this Magic Wooden Folding Table, students can have their breakfast, lunch or dinner while having a class because this folding table provide a special place for everything needed during online classes. Typically, folding table coming with only one-space and there is no special place either for drinking water nor stationery equipment which can caused water spilled on the items above the table. Therefore, students can use this Magic Wooden Folding Table to review their lessons easily as it can maintained their mood and energy levels.



Figure 1 Product of Magic Wooden Folding Table

Significance of Product

Magic Wooden Folding Table is an innovative product and it can solve the problems faced by students as it can become convenience, affordable and portable table. Students can bring this table everywhere since they need to find a place with high speed internet to study. This mobile desk is designed in mini size and this table is not a burden for students to be used in every location and situation.

Feasibility Study of Product

A total of 40 students participated in a survey, which was conducted to gauge the needs of the prototype and to predict consumer habits and measuring the level of awareness as well as buyer willingness to accept new products of Magic Wooden Folding Table. Majority of respondents which is 25 respondents comes from female students and 15 respondents from male students. Then, researcher also do a survey in student's rental house or hostel. In the rental house, there are the highest demand with 22 respondents and 8 respondents from the students who staying at home interested in this product. Through the questions posted by the respondents, result shown that almost all the students need this folding table for their use since most of the students currently doing online study instead of face to face. This folding table can be a comfortable equipment to them during the online learning sessions.

Marketability of Product

The Magic Wooden Folding Table has been produced with a unique shape and having a big opportunity in the market across the country. Besides, this folding table will be marketed through social media such as *facebook*, *instagram*, *shopee* and *lazada*. In addition, this Magic Wooden Folding Table can be supplied to the public such as schools. Other than that, seller can expand this folding table market plus increase sales over time. Magic Wooden Folding Table is designed with different shape and a wide range of functions. It has a unique criteria for folding table rather than normal portable table that commonly used by students. This table can attract the attention of students and instructors who are using laptops. Lastly, if the Magic Wooden Folding Table gets an overwhelming response, it might have a great opportunity to be marketed globally.

Acknowledgement

We would like to show our gratitude to Madam Siti Hajar Binti Muhd Ariff as our Supervisor for her guidance and support which enable us to complete this project successfully and brilliantly.

References

- Astro Awani (2020). Facts released by the World Organization for sharing about COVID-19. Retrieved from <https://www.astroawani.com/berita-malaysia/apa-lagi-anda-perlu-tahutentang-covid19-234299> on October 9, 2020.
- Berita Harian (2020). KPT confirmed the admission of new students from UA, IPTS from 1 July. Retrieved from <https://www.google.com/amp/s/www.bharian.com.my/node/693433/amp> on November 27, 2020.
- Campbell, D. (1989). *Develop Creativity*. Canisius Publishers. Retrieved from https://scholar.google.com/scholar?hl=en&as_sdt=0%2C5&q=usahausaha+memperkenalkan+inovasi+meja+mudah+alih&btnG=#d=gs_qabs&u=%23p%3DXVGv9K25DIYJ on November 27, 2020.
- Fajar Nur'aini Dwi Fatimah (2016). *SWOT Analysis Techniques*. Retrieved from https://books.google.com.my/books?hl=en&lr=&id=CRL2DwAAQBAJ&oi=fnd&pg=PR2&dq=MAKSUD+SWOT+pdf&ots=NVIEJg_uaxi&sig=UnzWyVul3neXoqbcXAuRyv6dSPM&redir_esc=y#v=onepage&q&f=false on October 12, 2020.
- Pejabat Perdana Menteri Malaysia (2020). YAB Prime Minister's Special Message on Covid-19. Retrieved from <https://www.pmo.gov.my/ms/2020/03/perutusan-khas-yab-perdana-menterimengenai-covid-19-16-mac-2020-2/> on October 16, 2020.

MINI HAND SANITIZER

Norbaini Binti Ghazali

Politeknik Kota Bharu, Kelantan, Malaysia
norbaini@pkb.edu.my

Nik Umira Fatinn Bt Nik Ismail, Koh Liew Min
Politeknik Kota Bharu, Kelantan, Malaysia
nikumirafatinn@gmail.com, Liewmin1999@gmail.com

Highlights: This Mini Hand Sanitizer is a product that has been designed and innovated because in covid-19-Pandemic everyone needs to use hand sanitizer especially when we are at the public. The purpose of using mini bottle hand sanitizer is easy to store in a bag or pants pocket. This Mini Hand Sanitizer is a product that makes it easier for customers if they want to use it because the user only needs to roll on the hands.

Key words: COVID-19, Pocket Size, Mini Hand Sanitizer .

Introduction

The Mini Hand Sanitizer is made using a small bottle to ensure the users can easily bring the hand sanitizer in anywhere. Due to the pandemic, it is important for everyone to have this Mini Hand Sanitizer as a way of protecting from the Covid-19 virus.

Mostly users have trouble carrying hand sanitizer because they might not have space to store and carry the hand sanitizer everywhere. In order to fulfil the users need nowadays, Mini Hand Sanitizer are made in a small bottle as well as suitable for use by all ages. To use the product, user just only need to roll the Mini Hand Sanitizer on their hands. The rolled-on bottle is a new packaging for hand sanitizer.

Product Development

The main material used in the development of Mini Hand Sanitizer is roll on bottle Only and hand sanitizer liquid. When to use it users only need to roll on the part of hand for 2 time.



Figure 1 Materials to Packaging Mini Hand Sanitizer

Significance of Product

Mini hand Sanitizer are small in size and easy to carry to everywhere. We produce one product that can help users by facilitating the use of hand sanitizer. This is because the user does not need to press the hand sanitizer bottle but they only needs to roll on hand. The use of Mini Hand Sanitizer can also be save because the bottle can be reused by refill after running out of the liquid.

Feasibility Study of Product

A total of 100 students took part in the survey, which was conducted to measure the need for Mini Hand Sanitizer and to measure the preference for use and recommendations given by Kota Bharu Polytechnic students to the product. The majority of respondents (90 respondents) felt that the Mini Hand Sanitizer is very economical in terms of use. A total of 10 respondents felt that the existing products were liked and were not interested in this Mini hand Sanitizer.

Marketability of Product

The cost to produce Mini Hand Sanitizer is quite expensive. However, production costs can be reduced if produced in larger quantities. The use of this Mini Hand Sanitizer is also safe to use for people with problems, because the ingredients used are 100% free of chemicals. This Mini Hand Sanitizer is easy to use, lightweight and economical while using and easily placed in a pocket or bag.

In the future, the researchers hope to promote Mini Hand Sanitizer by using social media such as Instagram, Whatsapp and Facebook. The product will be improved from time to time to attract the interest of prospects and customers.

Acknowledgement

We are grateful to Madam Norbaini binti Ghazali (as the Course Coordinator and Supervisor)) for their guidance and support which enable us to complete this project successfully.

References

- Berita Harian (2020). Retrieved from <http://covid-19.moh.gov.my/terkini/052020/situasi-terkini-28mei-202/KERATAN%20AKHBAR%2028%20MEI%202020-min.pdf> on 28 MEI 2020.
- Pietsch, Hanns (2001). Hand Antiseptics: Rubs Versus Scrubs, Alcoholic Solutions Versus Alcoholic Gels. *Journal of Hospital Infection*. 48 (Supl A): S33–S36. doi:10.1016/S0195-6701(01)90010-6
- Sinar Harian (2020). Retrieved from <https://www.sinarharian.com.my/article/74093/KHAS/Covid-19/Guna-hand-sanitizer-dengan-kadar-alkohol-60-hingga-80-peratus> on 16 MAC 2020 .
- U.S. Food and Drug Administration (FDA). 5 August 2020. Retrieved 10 August 2020. <https://duitcara.blogspot.com/2020/04/8-jenama-hand-sanitizer-yangterdapat.html?m=1>

AYAM PERCIK PRE-MIXED POWDER

Noraída binti Ismail @ Yusof

Politeknik Kota Bharu, Kota Bharu, Malaysia
noraidaismaail@gmail.com

Juli Suzlin binti Mohd Jalaludin, Nur Alifah Hafizah binti Ezairoskan, Nurul Shahida binti Jusoh @ Yusoff

Politeknik Kota Bharu, Kota Bharu, Malaysia

julisuzlin@gmail.com, alifahhafizah00@gmail.com, nurulshhida@gmail.com

Highlights: Ayam Percik Pre-Mixed Powder is an innovation based on researcher's observation on consumer needs and preferences. Ayam Percik has been one of famous cuisine in Malaysia especially during the month of Ramadhan. As more women getting involve as working parents, they are becoming more busier to prepare meals for the family. The lifestyle has change, the need for instant foods, sauces, pastes and others are becoming a significance these days. Ayam Percik Pre-Mixed Powder offers another choice to the consumers for easier and faster preparation cooking time, plus and advantage for those who does not know how to cook this cuisine.

Key words: Ayam Percik, Pre-Mixed powder

Introduction

Ayam percik is a grilled chicken dish that is cooked with rich coconut gravy. It is one of many famous Malaysian cuisine and originated from the Northern Malaysian state of Kelantan. Ayam Percik Pre-Mixed Powder offers a faster and easier way for the user to home cook with ease. This product is designed and produced to help working parents or even homemaker to save time and prepare delicious meals for their family. As everyone know, cooking ayam percik could take some time and not everyone manage to prepare the gravy tastily. This product can offers all features - fast, easy and delicious in a bottle.

Product Development

The main ingredients used in the development Ayam Percik Pre-Mixed Powder are shallot, garlic, ginger, almond powder, nutmeg, lemongrass, chili powder, coconut milk powder, sugar, salt, and seasoning. Firstly, the ingredients such as shallot, garlic and ginger are sliced thinly and dried using the food dryer for 24 hours. Then, all the dried ingredients, and nutmeg are blended finely using the dry grinding machine. After that, mixed it well with the rest of the ingredients and filter it with flour sifter. To use the product, it is only need to be mixed with some water and boil it until the gravy is cooked and thickened. This gravy can later be marinated with half-boiled chicken and grilled in oven or open fire.



Figure 1 Finished product "Ayam Percik Pre-Mixed Powder"

Significance of Product

Ayam Percik Pre-Mixed Powder is one of a kind and made of fresh ingredients, as it uses materials that are locally available, and free of chemicals. This product is convenient, easy to use and very user friendly, not to mention it is also cheap.

Feasibility Study of Product

A total of 30 respondents participated in a survey, which was conducted to identify the respondent's perceptions towards the product. A total of 95% agreed that this product satisfy and fulfill their taste. 95% also agreed that this product is helpful and can save their time to cook.

Marketability of Product

The cost of producing Ayam Percik Pre-Mixed Powder is cheap. The cost of this product per bottle is less than RM20.00 and can be used for three servings. The cost of production may be reduced if it is produced in a bigger quantity and used of cheaper packaging. This pre-mixed powder has commercial potential since it is cheap, one of the kinds in its range. From researcher survey, there is no other similar product (powder). The closest is in in form of paste. The usage is also easy and 100% free of chemicals. It is tasty, convenient and user friendly. In the future, the researchers hope to promote Ayam Percik Pre-Mixed Powder using social media such as Instagram, WhatsApp and Facebook. The product features and packaging will be improved to appeal to prospects and customers and ease postage and delivery.

Acknowledgement

We are grateful to Puan Juli Suzlin binti Mohd Jalaludin (as the Course Coordinator) and Puan Noraida binti Ismail @ Yusof (as supervisor) for their guidance and support which enable us to complete this project successfully. A very special thank you also conveyed to the staff at Pejabat MARDI Pasir Puteh, Kelantan for the ideas and information regarding this project.

References

- Editor Daily Makan. (2020). Anda Wanita Bekerjaya Tidak Sempat Memasak? Perlu Baca Ini. Accessed on 19 Mei 2021 from <https://dailymakan.com/wanita-bekerjaya-tidak-semapat-memasak/8200/>
- Nur Farah Hani Muhammad. Et al. (2012). Pemprosesan kuah asam laksa segera. Buletin Teknologi MARDI. Bil. 2 (2012): M.S. 51-57. Accessed on 25 Mei 2021 from <http://ebuletin.mardi.gov.my/buletin/02/Pes%20asam%20pedas.pdf>
- Anon. (2010). Akta Makanan (1983) dan Peraturan Makanan (1985). Kuala Lumpur: MDC Publisher Printers Sdn. Bhd. M.s. 263–264.

UIJA TWIST

Razia Malini binti Mohamad

Commerce Department, PKB, Ketereh
zialinimohamad@gmail.com

**Rosilah binti Wok, Syahidatul Aqma binti Mohd Zamri,
Nurul Izzaty Akmal binti Ropi, Faridatul Hamidah binti Zulkifli**

Commerce Department, PKB, Ketereh
pn_rosilah@yahoo.com.my, aqamasyahidatul@gmail.com, izzatyropi@gmail.com, hamidahzulkfli@gmail.com

Highlights: The whole world was rumoured to have an incredible outbreak of Covid-19 and it spread so fast. Covid-19 virus can be spread through liquid droplets produced from saliva splashes when talking or coughing. People need to practice social distance to avoid the risk of contracting the Covid-19 virus. 24-hour convenience store operation, all restaurants, grocery stores are allowed to operate until 12 midnight. The government gave flexibility to restaurant by ensuring that the practice of social distancing was practiced at every restaurant dining table. This being the case, social distancing still needs to be practiced to reduce the spread of Covid-19 outbreaks in the premise. Most of the dining table, especially high chair for baby are much dirtier than other tables in restaurants. Parents who are dining at the restaurant with their baby might be use the baby chair prepared by the restaurant and it will be one of physical hazard towards contracting the Covid-19 virus. Uija Twist is created with two products in one: a baby highchair and adults chair. It makes the list of best baby high chair for many reasons, including its easy-to-clean surface, wooden exterior, and ergonomic seat that brings baby to the dining table. It can be used as a precaution to oneself or consumers from meeting others while on the go, especially in restaurants. The seat in the children's section also provides hooks for safety purposes so that the seat does not sway and is stable. There's also no need to worry about set-up, since the user simply need to pop in the legs and they're good to go. This chair can be folded, and it is a space saver product. In conclusion, Uija Twist is safe to use by children and adults.

Key words: Covid-19, restaurant, baby chair, dirty, uija twist, two-in-one

Introduction

Grijalva (2008) in her writing stated that according to University of Arizona Microbiologist, Dr Charles Gerba says "The best friend a germ ever had is a baby. You put him in a high chair and that's basically a playground for germs for them, because they're not only putting them there, they're picking them up." When you put your child in a restaurant high chair, you could be putting her on the hot seat, a pile of germs. He says high chairs might look clean, but a lot of them are not what they seem. Surveys show that the surface of this baby table is much dirtier than other tables in restaurants. Although it rarely causes severe pain, it may contain dangerous germs such as Coliform.

Content

a. Development Process

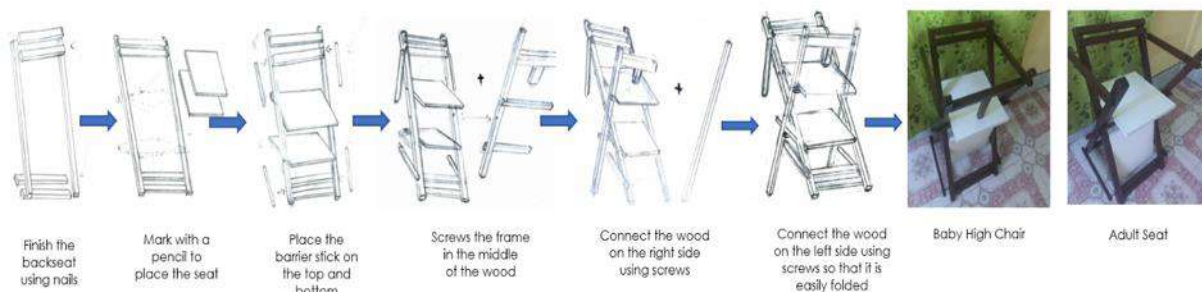

b. Background

The two-in-one innovation product named Uija Twist is developed as one of the risk control method to reduce the spread of Covid-19 epidemic faced by the community nowadays. Uija (의자) is come from korean word means chair. The idea came from the brainstorming among researcher and observation at the restaurant. Based on the observation, 80% of the baby high chair at the restaurant are not sanitized regularly and looks dirty.

c. Importance

1. Uija Twist is helping children and adults from the exposed to the covid-19 virus.
2. Used as one of the risk controls to reduce the rate of transmission of covid-19 virus infection at outdoors, especially in restaurants.

d. Advantages

1. Made of natural wood, nature friendly material as the best choice to use. An excellent choice of wood, which is related to hardwood meaning that the high chair will be distinguished by its high trustworthiness and resistance to thirst.
2. Cleanliness: **easy-to-clean surface**.
3. Space saver product: one of the best high chairs for small spaces, since it folds quickly for compact, easy storage and making Uija Twist a good choice for occasional use.
4. Save user power: no need to worry about set-up, since the user simply need to pop in the legs, and they are good to go.
5. Affordable: this high chair has two mode settings: baby high chair and adult chair which gives user even more money to save.
6. Interesting design and have commercial value for market segmentation.

e. Commercial Value

Table 1: Commercial Value of Uija Twist

Num	Items	Percentage (%)	
		Yes	No
1	I know Covid 19 can be infected through touch	98.5	1.5
2	I am cares about cleanliness and safety	100	0
3	I think the safety of my children will be affected if they use chairs in restaurants	74.2	25.8
4	The cleanliness of the chairs in the restaurant is guaranteed	50	50
5	Uija Twist has safety features	88.9	11.1
6	Uija Twist does not need to be washed and sanitized	45.2	54.8
7	Uija Twist is a space saver product	87.9	12.1
8	Uija Twist is two-in-one chair for baby and adult as well as saving money	96.7	0.3
9	Uija Twist can attract the interest of users because of its attractive design	92.3	7.7
10	The desire of parents to have an Uija Twist is high	83.6	16.4

The data shows that Uija Twist can be marketed through the psychographic segmentation because the lifestyle of the consumer is concern about hygiene especially during the pandemic.

References

- Grijalva, B. (2008, May 29). *The Hot Seat: Dirty High Chairs In Restaurants*. KOLD News 13. Retrieved 20th August 2020 from <https://www.kold.com/story/8392643/the-hot-seat-dirty-high-chairs-in-restaurants/>
- Kalbana Perimbanayagam. (2020, June 9). *All 24-hour convenience stores can now remain open until midnight*. NSTTV. Retrieved 25th August 2020 from <https://www.nst.com.my/news/nation/2020/06/599190/all-24-hour-convenience-stores-can-now-remain-open-until-midnight>
- London, J. (2019, March 25). *Baby high chairs in restaurants hold more bacteria than some public toilets*. RSVP Life. Retrieved 20th August 2020 from <https://www.rsvp.live.ie/life/family/baby-high-chairs-restaurants-hold-14183402>
- Shweta Saxena. (2020, Nov 25). *Baby high chair: For a fuss-free mealtime*. Retrieved 10th September 2020 from http://timesofindia.indiatimes.com/articleshow/78948044.cms?utm_source=contentofinterest&utm_medium=text&utm_campaign=cppsst
- Zakiah Koya. (2020, May 1). *Conditional MCO: Dine-in at restaurants allowed but with conditions, says PM*. TheStar. Retrieved 4th September 2020 from <https://www.thestar.com.my/news/nation/2020/05/01/conditional-mco-dine-in-at-restaurants-allowed-but-with-conditions-says-pm>

CROWDFUNDING AS A TOOL FOR ENTREPRENEURSHIP EDUCATION IN HEIs

Ahmad Ridhuwan Abdullah

Universiti Malaysia Kelantan, Kota Bharu, Malaysia
ridhuwan.a@umk.edu.my

Zul Karami bin Che Musa, Siti Salwani binti Abdullah, Dzulkifli bin Mukhtar, Muhammad Naqib Bin Mat Yunoh, Mohd Shahril Nizam Bin Md Radzi, Mohd Zulkifli bin Muhammad, Mahathir bin Muhamad, Abd Aziz Bin Mat Hassan, Siti Afiqah Binti Zainuddin, Siti Rohana Binti Mohamad, Nur Farahiah Binti Azmi, Nur Izzati Binti Mohamad Anuar, & Siti Nurul Shuhada Binti Deraman

Universiti Malaysia Kelantan, Kota Bharu, Malaysia
zul@umk.edu.my, salwani.a@umk.edu.my, dzulkifli@umk.edu.my, naqib@umk.edu.my,
zulkifli.m@umk.edu.my, mahathir.m@umk.edu.my, abdaziz.mh@umk.edu.my, rohana@umk.edu.my,
shuhada.d@umk.edu.my, nurfarahiah@umk.edu.my, nurizzati.ma@umk.edu.my

Highlights: Crowdfunding is one of the new alternative financial resources that can be used by all individuals, especially the nascent or young entrepreneurs. Crowdfunding is seen to be able to improve the skills and interests of students by providing real training for them to become entrepreneurs during their study period at HEIs. Therefore, this project aims to form a complete framework to ensure the success of implementing crowdfunding as one of the tools to assist these HEIs in improving the effectiveness of their entrepreneurship education. As a result, the project has successfully developed a full working platform and is ready to be utilized by HEIs.

Key words: *crowdfunding, financial resources, HEIs, entrepreneurship education*

Introduction

Higher education institutions (HEIs) have problems in offering effective entrepreneurship education ecosystem to students (Rahim et al., 2015). Two important issues are often associated to this issue. The first is to provide the best platform to carry out effective teaching and learning activities. The second is financial resources for students to realize student entrepreneurial ideas. Interestingly, crowdfunding is seen to be able to solve both issues if it can be implemented well in HEIs.

Many see crowdfunding as just one of the new alternatives for nascent entrepreneurs to gain financial resources. However, it should be noted that the processes involved in obtaining financial resources through crowdfunding are very practical for entrepreneurship education ecosystem (Cho et al., 2019). Processes such as product development (e.g., various processes ranging from idea creation to prototype production), marketing (e.g., pricing, production of marketing content such as video, and marketing segmentation), logistics (e.g., processes involved when ordering raw materials or components and delivery of finished products to customers), and customer service (activities during and after purchase or delivery of products).

On average, only quality projects, which will be successful after the completion of the crowdfunding campaign period (i.e. the period of offering to the public to support the project of interest by giving a little money depending on the campaign duration of a project, usually between 30 and 40 days). A quality project is a project that is ensured by an entrepreneur who has achieved the required level of quality for each of the above processes. Therefore, these processes are very important to be exposed to students to equip them with the basic skills in the world of entrepreneurship. If the student entrepreneurship project is successful, they will get sufficient funds to complete their project and subsequently get involved directly into the real world of entrepreneurship.

However, the implementation of crowdfunding in HEIs requires research to identify and understand all the elements involved. Therefore, a full framework for the implementation of crowdfunding in HEIs needs to be made through in depth studies to ensure the successful implementation.

Finally, based on the framework, we develop a crowdfunding platform dedicated to the HEIs community. The platform has been tested and a number of crowdfunding projects created by the students have successfully raised more than RM9,000. The students gained valuable experience and most of them are eager to become a project creator on the platform again.

Objective

The objectives of this project are to formulate a crowdfunding framework and develop a dedicated crowdfunding platform for the higher education institutions (HEIs) students, that has all the required elements for successful implementation and sustainable.

Methodology / Method of Implementation

This project has two phases:

1. Firstly, we conduct a qualitative research in order to gain an in-depth understanding of the essential elements in the ecosystem of HEIs for the successful implementation of crowdfunding; and
2. Secondly, we develop a dedicated crowdfunding platform for HEIs, perform a test run procedure, and published the final working system of crowdfunding for HEIs.

Results

1. A full crowdfunding framework has been successfully produced as a reference for the implementation of crowdfunding in HEIs.
2. A working system or platform for HEIs crowdfunding. The crowdfunding platform or system is ready to be introduced to the market or commercialized. We call our platform as UniStartr, which can be viewed through <https://unistartr.com/>

Impact / Effectiveness

Contribution to Community / Country / IR4.0 - This project is seen to be able to solve issues related to the provision of entrepreneurship education ecosystem in HEIs as well as the lack of financial resources for students who are interested in becoming entrepreneurs. This project is also seen to be able to achieve the country's aspirations in entrepreneurship education, which is related to the two national policies, namely the IPT Entrepreneurship Action Plan (Ministry of Higher Education Malaysia) and the National Entrepreneurship Policy 2030 (Ministry of Entrepreneur Development and Cooperatives).

Acknowledgement

We acknowledge the financial support provided by the Ministry of Higher Education Malaysia under the FRGS Grant and Geran Keusahawanan Berimpak Tinggi. We also acknowledge Faculty of Entrepreneurship and Business, Universiti Malaysia Kelantan for the facilities. Special thanks also to those who contributed to this project directly and indirectly especially to my family, CRI 2021 team-mate and officemate.

References

- Cho, M., Lemon, L.L., Levenshush, A.B. et al. Current students as university donors?: determinants in college students' intentions to donate and share information about university crowdfunding efforts. *Int Rev Public Nonprofit Mark* 16, 23–41 (2019). <https://doi.org/10.1007/s12208-018-00217-9>
- Rahim, H. L., Kadir, M. A. B. A., Abidin, Z. Z., Junid, J., Kamaruddin, L. M., Lajin, N. F. M., ... & Bakri, A. A. (2015). Entrepreneurship education in Malaysia: A critical review. *Journal of Technology Management and Business*, 2(2).

BRIDGING THE GREEN GAP: AN INTEGRATED FRAMEWORK TO UNDERSTAND CONSUMERS' ACTUAL CONSUMPTION DRIVING FORCES TOWARD ORGANIC FOOD IN MALAYSIA

Brahim Chekima

Universiti Malaysia Sabah, Kota Kinabalu, Malaysia
bchekima@ums.edu.my

Azaze-Azizi Abdul Adis, Suddin Lada, Rozilee Asid, Toh Pei Sung

Universiti Malaysia Sabah, Kota Kinabalu, Malaysia
azizi@ums.edu.my, suddin@ums.edu.my, rozilee@ums.edu.my, tohpeisung@ums.edu.my

Highlights: Preceding studies' foci were on examining the intention to purchase organic food as a proxy to consumption, resulting in the green gap or behavior gap. These studies failed to embrace the consumption itself where purchasing may come secondary to consumption decisions. Consumption reflects high involvement with the product; and the barriers and motivations are as real as the product itself, which makes it an ideal moment to examine the motivation. Hence, this research proposed a new approach to bridge the gap by investigating factors that influence the use of organic foods by focusing on those who consume and not those who consider buying organic foods. In addition, the theory of planned behavior is extended by incorporating temporal orientation that is a prevalent and influential yet unrecognized impact on many of the human behavior as well as intrinsic and extrinsic quality cues that received minimal attention in the organic food domain compared to the conventional alternative.

Key words: *Green Gap, Extended Theory of Planned Behavior, Bi-Dimensional Attitudes, Intrinsic and Extrinsic Quality Cues, Future Orientation, Structural Equation Modeling*

Introduction

Exploitation and destruction of the environment and natural resources have raised awareness of environmental protection, which in turn has encouraged "green consumerism". Due to this condition, over the last 15 years, the practice of organic agriculture and organic food, in general, has gained a huge interest. Despite being topical research, its consumption and market growth remains a niche in many places, especially in Malaysia. FIBL-IFOAM (2021) and Suhaimee et al., (2017) of MARDI, reported that organic food is still considered a niche product, and organic farming shares only 0.01% of agricultural land in 2021. Several researchers argued that the clear issue at hand is perhaps the most consistent finding which is Inconsistency between what people claim (intention) and their actual behavior –the so-called "green gap" (e.g. Hansmann et al. 2020; Chekima et al. 2019; Carrington et al. 2014). Responding to this theoretical prediction gap and problem in the literature, the central proposition of this research is that 'organic food actual consumption behavior' is an ideal concept in this context compared to purchase intention. Consumption reflects high involvement with the product; and the barriers and motivations are as real as the product itself, which makes it an ideal moment to examine the motivation. Present research approaches organic food consumption in Malaysia with the theory of planned behavior (TPB). In contrast to common interpretations and operationalization of the constructs, attitude is conceptualized as a bi-dimension that is the product-specific attitude and environmental attitude as both differ greatly in their orientation. In addition, the theory of planned behavior is extended by incorporating temporal orientation that is a prevalent and influential yet unrecognized impact on many of the human behavior as well as intrinsic and extrinsic quality cues since food choice and consumption preferences are decided based on a variety and diverse complex elements. These constructs also received minimal attention in the organic food domain compared to the conventional alternative.

Context

As this research is concerned with organic food actual consumption, a purposive sampling technique was employed. The data were collected from only individuals who consume organic food as this is required to determine the actual factor influencing organic food consumption and not those who are aware of organic food or possess the intention to purchase organic food. A total of 150 questionnaires were collected from organic food eaters in Malaysia and the participation of respondents in the study was on a voluntary basis.

Benefits to the Economy, Society, Environment & Body of Knowledge

From a practitioner perspective, local and international producers and marketers interested in expanding their organic product market in Malaysia may consider the findings of this study to aid in designing an effective strategy that they can effectively communicate to consumers to encourage more consumption of organic food, ultimately increase their sales, and simultaneously achieve a bigger market share in the food industry. This is valid since models predict intention to buy ethically is not exactly representative of ethical behavior 90% of the time (Futerra, 2005). Futerra (2005) affirmed that this situation has profound implications - product launches based on intentions to purchase are more than likely to result in costly failures. This dilemma is once again highlighted and emphasized by Chekima et al., (2019), Miniero et al., (2014) and Moisaner et al., (2010) to look at consumption than focus on research guided or grounded on individual purchasing intentions.

By fostering the consumption of organic food, simultaneously this will help the Malaysian government to materialize its National Agricultural Plan (NAP) to increase organic agricultural land share which is just 0.01% at the moment, decrease chemical fertilizer in an effort to improve the environment as well as boost income growth among growers. As for the community, consumption of organic food could promote better health as part of the sustainability objective of the ecosystem holistically. Ultimately, this will lead to sustainable development in the country through sustaining soil fertility, reduction in pesticide usage and reduction in water and air pollution, product packaging as well as disposal.

It also adds new momentum to the growing literature on organic food consumption behavior. It paved the way for future researchers in approaching this problem to replicate this study by testing different organic food product segments, samples from other countries or conduct a cross-cultural comparison to substantiate organic food consumption behavior and business managerial practice. Such similarities or differences will help draw more justification on the dilemma of investigating purchase intention to understand and identify organic food consumption factors and closing the green gap.

As a pioneering study that operationalizes attitudes as a bi-dimensional construct; environmental attitudes and product-specific attitudes, latter were found to be strong drivers for influencing organic food consumption behavior whereas environmental attitudes did not play a role as influencers as previously reported. This confirms Ajzen's (1991; 2013) and Thøgersen's (2004) claim that general attitudes (e.g. environmental attitudes) do not necessarily spill over into most behaviors or specifically environmentally friendly behaviors. Based on this operationalization, future research can similarly employ product-specific attitudes to substantiate this finding.

In addition, the future orientation construct was found to strengthen the relationship between the predictors and organic food consumption behavior, confirms that it plays a pervasive impact on people's behavior especially in the context of organic food consumption and future researchers should take this into account. This corroborates with the practice and its outcome that monetary and non-monetary benefits related to environmentally friendly consumption normally become salient over the long term.

Acknowledgement

The funding of this research is obtained through research grants from the Universiti Malaysia Sabah under grant no of [SLB2011].

References

- Ajzen, I. (2015). Consumer attitudes and behavior: The theory of planned behavior applied to food consumption decisions. *Rivista di Economia Agraria*, 70(2), 121–138.
- Carrington, M., Neville, B. A., & Whitwell, G. J. (2010). Why ethical consumers don't walk their talk: Towards a framework for understanding the gap between the ethical purchase intentions and actual buying behaviour of ethically-minded consumers. *Journal of Business Ethics*, 97, 139–158.
- Chekima, B., Chekima, K., Chekima, K. 2019. Understanding Factors Underlying Actual Consumption of Organic Food: The Moderating Effect of Future Orientation. *Food Quality and Preference*. 74, 49-58.
- FIBL-AMI Survey (2021). <https://www.fibl.org/fileadmin/documents/shop/1150-organic-world-2021.pdf>
- Hansmann, R.; Baur, I.; Binder, C.R. Increasing organic food consumption: An integrating model of drivers and barriers. *J. Clean. Prod.* 2020, 275.
- Suhaimee, S., Ibrahim, I. Z., & Abd Wahab, M. A. M., (2017). Organic agriculture in Malaysia. *FFTC Agricultural Policy Articles*.
- Thøgersen, J., & Olander, F. (2003). Spillover of environment-friendly consumer behavior. *Journal of Environmental Psychology*, 23(3), 225–236

PI-ASISSTANT COMBO: PROMOTION ITEM COMBO TOOL TOHELP RETAIL INDUSTRIES TO SET OPTIMAL PROMOTION ITEMS

Ts. Dr. Wan Nor Munirah Ariffin

Center of Excellence Geopolymer and Green Technology, Faculty of Applied and Human Sciences,
Universiti Malaysia Perlis
munirah@unimap.edu.my

Ts. Muhamad Hafiz Masran¹, Dr. Nor Azrita Mohd Amin¹, YM Prof. Dr. Hjh Raja Suzana Raja Kasim², Dr. Emy Aizat Azimi³, Prof. Ts. Dr. Mohd Mustafa Albakri Abdullah⁴

¹Faculty of Applied and Human Sciences, Universiti Malaysia Perlis,

²Universiti Malaysia Kelantan,

³Faculty of Applied Science, Universiti Teknologi Mara Perlis,

⁴Center of Excellence Geopolymer and Green Technology Universiti Malaysia Perlis

hafizmasran@unimap.edu.my, norazrita@unimap.edu.my, rajasuzana@umk.edu.my, emyaizat@uitm.edu.my,
mustafa_albakri@unimap.edu.my

Highlights: Many industries spend a lot of time, energy, and money to manage the inventory they owned. The retail industries need to clear up all their slow-moving products at the same time need to maintain the total revenues. This is happened because of the company having problems in managing the products which cause the product dumping and finally lead to decrease in total revenue. This is something need to be focusing on to avoid loss and the worst case which lead to bankruptcy. We design an algorithm that optimally transform and produce the best pairing products for retailers do sales and promotion from graph network analysis. The existing matching and partitioning technique attempt to overcome these disruptions by implementing the algorithm based on product network categorization. The proposed algorithms were coded, and the simulations were run for the model using respective program developed by JavaScript programming language with D3 library. Based on the results, the proposed models give better optimality index by 20.83% compared to previous works. This research provides fundamental solution and better understanding to avoid cycle on assignment problems thus helping organizations or companies to increase the efficiency in planning. It will give a great impact and benefit the retail industries where model and algorithms can be adjusted in their software and applications.

Key words: *Graph network analysis, product category management, matching and partitioning technique.*

Introduction

Product category management for goods and management involves continuous analysis and includes demand management. It manages product categories in business unit to achieve improved outcome effectively and efficiently. Our innovation is motivated from the product network analysis graph which is applied to the category management. The design of the innovation is from the foundation of products which are from the same micro category, creating category loyalty and cross category sales. Do you ever see there are many slow-moving products on the shelves and still in the store? The slow-moving products must be sold quickly to avoid product expired and decreasing in monthly total sales. So, how to do this? The next section will explain about the black box of the innovation.

The Innovation Design

- i. The development of the innovation based on the consumer data transaction to obtain the subcategory of the products purchased by the consumers. The purchased items also determined the consumer behavior. From these relationships, we can discover what items the consumers always buy together, so that in the end, our innovation could propose what are the most optimal pairing items the retail industries can offer to consumer whenever they launch promotion period.
- ii. As an example, at a drug store, it has 7 divisions. Each division has its own category of products. For each product, it is also containing few more products and brands. This information are important to the development of product category.
- iii. Each transaction must be recorded and translated into data set.
- iv. The development of the algorithm (Patent File: PI2020004798).
- v. The results of the product category based on the connection of the nodes.

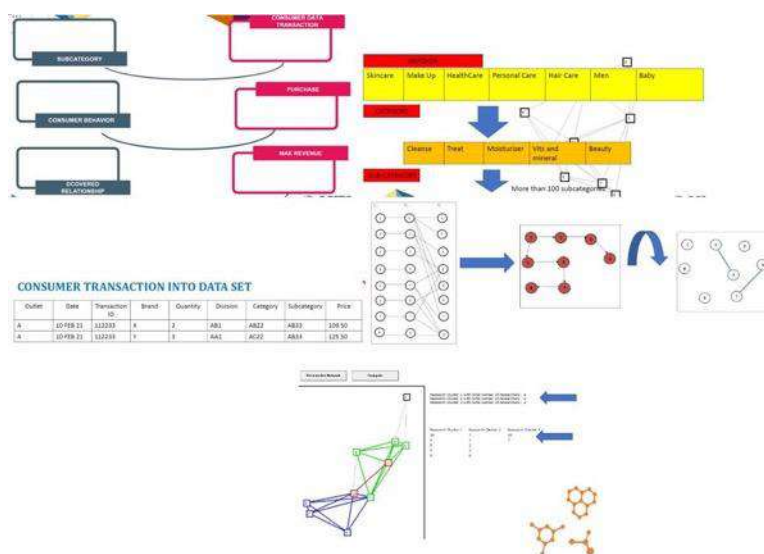

Benefits to the Retail Industries

Combo Promotion for Slow-Moving Products

1. Manage to identify the CORE PRODUCT (CP) and the PAIR PRODUCT (PP) from the SAME CLUSTER.
 - Sell CP at retail price and PP at mark down price
 - Sell CP at mark down price and PP at mark down price.
2. Manage to identify the CORE PRODUCT (CP) and the PAIR PRODUCT (PP) from DIFFERENT CLUSTERS.
 - Sell CP at retail price and PP at retail price.
 - Sell CP at retail price and PP at mark down price.

Benefits to Other Industries

1. Food selection based on patient preferences according to the optimal diet intake as well as restructure the hospital bills.
2. Logistic company.
3. Manufacturing company.

Cost Per Tool

Table 1. The Cost Per Tool

MATERIALS	PRICE	TOTAL PRICE
CD	RM 3.50/unit	RM 3.50
Packaging	RM 0.20/unit	RM 0.20
Internet	RM 150/month	RM 15.00
TOTAL		RM 18.70

References

WNM Ariffin , S Salleh. (2016). Bi partition approach of directed cyclic task graph onto multicolumn processors for total completion time minimization task assignment problem. AIP Conference Proceedings 1775 (1), 030072.

WNM Ariffin , S Salleh. (2018). The Reduction of Directed Cyclic Graph for Task Assignment Problem. MATEC Web of Conferences, EDP Sciences. 150, 06031.

Fabio P and Ueverton S. Souza. (2018). Decycling a graph by the removal of a matching: new algorithmic and structural aspects in some classes of graphs. Discrete Mathematics & Theoretical Computer Science, vol. 20 no. 2, Graph Theory.

Hafnaoui I, Rabeh A, gabriela N, Giovanni B. (2017). Scheduling real time systems with cyclic independence using data criticality. Des Autom Embed Syst. 21:117-136.

Zhen L, Zhuge D, and Zhu S.L. (2017). Production stage allocation problem in large corporation. OMEGA - The International Journal of Management Science, vol. 73, pp. 60-78.

KETAPANG POUCH

Roslina bt Ab Rahman

Politeknik Kota Bharu, Kelantan, Malaysia
roslinaar@pkb.edu.my

Muhammad Mukhlis bin Hamdan, Nur Azlin Asyikin binti Azizi, Muhammad Naim Aiman bin Razali

Politeknik Kota Bharu, Kelantan, Malaysia
Nurazlinasyiqin@gmail.com, Mukhlis189@gmail.com, aimannaim422@gmail.com

Highlights: The ornamental fish industry is a new industry that can provide returns of up to millions of ringgits in Malaysia. According to Mohd Zaini as asserted by Ministry of Agriculture and Food Industries, this industry has managed to contribute sales of RM370 million in 2018. It has attracted attention from various parties especially from youngsters who believe to its potential in generate an income. Nowadays, Betta fish has become one of the popular ornamental fish beside gold fish, clown fish, oscar fish and many more since it comes with various colour and a unique type of tail. A huge demand from domestic and international market for example from Singapore, Vietnam and China toward betta fish had influence the breeders or marketers to come out with the fish care product line which focus in taking care and upgrade the quality of the fish. Due to this strong growth opportunity and the aim to solve the problem faced by the breeders, Ketapang Pouch is introduced to the market. Packed into a colourful nonwoven pouch with triangle shape, its appearance is very eye catchy and can be tossed out easily after used.

Key words: *betta fish, ornamental fish industry, breeder, nonwoven pouch, triangle shape, fish care product line*

Introduction

Indian Almond leaves or Ketapang leaves come from the Terminalia Catappa tree. Ketapang leaves have been used for generations by an ornamental fish breeder especially the betta fish breeder. Since the leaves can be easily found around the neighbourhood especially at a sandy area, it become a low-cost medium to be used in taking care the fish. Basically, the dry Ketapang leaves is being processed in order to get the extract. Currently, there are TWO (2) ways on how ketapang leaves can be processed. The first method is to soak or boil the leaves first in a separate container. However, the disadvantage of this method is that the extract cannot be stored for too long because it will turn into mucus after certain period of time. The second method is to directly insert the cleaned ketapang leaves into the aquarium. The disadvantage of this method is that, the aquarium tends to look dirty with the leaves mess and require additional cleaning effort by the breeder.

Content

The use of Indian Almond leaves which also known as ketapang leaves as a natural medium to maintain the health quality of betta fish has received very good feedback from the player in the ornamental fish industry. By considering the huge potential of betta fish industry and the advantages offer by ketapang leaves to the fish itself, it is very important for all the players in betta fish industry to figure out the most convenient and innovative idea of product that can be made from ketapang leaves.

Ketapang Pouch is developed by using coarse grind leaves of Ketapang, together with aquarium salt and fish antiseptic. It is packed into a colourful nonwoven fabric which is easy to be dispose. This fabric material is very light and able to maintain in floating position, thus indirectly can attract the fish to swim around it. The product is design in 5.5x5cm triangle shape's pouch. Each pouch contains 2g of weight and for now it comes with three (3) variants colour: black, blue and purple.

As considering to Ketapang Pouch's product attributes, the main advantages bring by the product are, it can be tossed out easily after used and its appearance is very eye catchy. In addition, the product has the ability to be used as a natural and low-cost fish's remedy. Beside cost effective, it also offers certain benefits to the betta fish which are lower PH of the water, increase breeding survivability and enhance the colour of the fish for short term period. It also can be used to cure the wounds and provide energy for depresses betta fish.

Acknowledgement

We are grateful for the opportunity given by Allah S.W.T for allows us to be able to conduct the writing about the innovation of Ketapang leaves, especially in the aspect of packaging. We hope in future there will be further writing regarding the potential of Ketapang leaves.

References

- Bernama. (2018). Penternak diminta Hasil Ikan Pelaga Berkualiti Tinggi. Retrieved from <http://astroawani.com> on 20th August 2021.
Mohd Z. (2021). Ternakan Ikan Laga Beri Pulangan Lumayan. Retrieved from <http://www.malaysiagazette.com> on 2nd August 2021.

MODELING THE TALENT SHORTAGE THROUGH SUPPLY AND DEMAND ATTRIBUTES FOR YOUTH IN ISLAMIC BANKING INSTITUTION

Mohd Ikhwan Aziz

Universiti Malaysia Kelantan, Kota Bharu, Kelantan
ikhwan.a@umk.edu.my

Hassanuddin Hassan, Sathiswaran Uthamaputhran, Azwan Abdullah, Siti Norjannah Mohd Jamil

Universiti Malaysia Kelantan, Kota Bharu, Kelantan
Hasann@umk.edu.my, sathiswaran@umk.edu.my, azwan.a@umk.edu.my, nurjannahmohdjamil@gmail.com

Highlights: This paper present the model for talent shortage among young generation by using demand and supply attributes. The presented model highlights the usage supply and demand attributes to improve the talent shortage in Islamic banking institution at entry level. This implementation would increase entry level effectiveness among young generation. The assessment used IBM-AMOS software in determine the root cause of talent shortage in Islamic banking Institutions.

Key words: *Talent Shortage, Demand and Supply, Modeling, Young Generation*

Introduction

In recent years, Islamic banking has developed into an extraordinary and rapidly expanding segment of the international banking and capital markets, and it has continued to grow. The Islamic banking system's mission is to provide a diverse range of religiously acceptable banking services to both Muslim and non-Muslim customers, regardless of their religious affiliation. Participants in Islamic doctrine are committed to eliminating interest, wagering and uncertainty in all their forms from the financial systems of the countries in which they live. There are many people who are curious about how Islamic banking differs from conventional banking in terms of its system, operation, product, development, and other aspects, and who are interested in learning more about it. This conventional banking system, which provides banking services to consumers, is not immune to economic turbulence, as demonstrated by the collapse of a giant conventional bank in the year 2021. This is because conventional banking systems are not immune to economic turbulence because they are established and well-established. Many investors have become interested in Islamic banking as a result of this, prompting them to diversify their investment portfolios into Islamic banking markets, according to the report.

Islamic banking's development and growth is based on talent development and growth. It is the most valuable asset in the industry, and it will continue to be at the forefront of the industry's continuous improvement agenda in order for the industry to maintain its resilience while achieving sustainable growth. As a result of the increasing momentum that Islamic banking institutions have demonstrated, a significant portion of the 200,000 workforces that will be required by Islamic banking institutions by the year 2020 in a variety of fields has been created. Therefore, in order to meet demand, the Economic Transformation Programme (ETP) aims to increase the number of students enrolled in Islamic finance from the current 6,000 to 54,000 by 2020. As part of its overall goal, the ETP aspires to increase the number of employable Islamic banking graduates from 64.8 percent in 2010 to 80 percent by the end of the programme in 2015. According to the most recent available data, there are only 17,621 workforces available in Islamic banking institutions today, which accounts for only 11 percent of the workforces required by Bank Negara Malaysia, according to the most recent available data.

Malaysia's talent shortage has increased to 82 percent in Islamic banking institutions, compared to an industry average of 76 percent and a benchmark of 78 percent in conventional banking institutions, according to the latest figures. In relation to this specific matter, the BNM has simultaneously launched the human capital development plan through its agencies, as well as through education and knowledge service providers and other stakeholders. Numerous educational and knowledge-based service providers, as a result, created programmes that were based on the principles of Islamic banking.

Content

Please include as many of the following sections as possible in your paper, as relevant.

1. **Description:** A quantitative technique used to develop the talent shortage model. The process development begins from identification of supply and demand attributes for talent shortage caused. Once the attributes were identified, a set of indicator assessment developed that is structured questionnaire. The questionnaire distributed among 371 graduates to acquire probability data. The data gathered have been analyses by using IBM-AMOS to generate a model of talent shortage. The model of talent shortage deem fitted, validated, and generalised based on the fitness index criteria (the chi-square normalised by degrees of freedom (Chisq/df) be less than 5.0, the Comparative Fit Index (CFI), the Goodness Fit Index (GFI), the Tucker-Lewis Index (TLI), and the Normal Fit Index (NFI) be all greater than 0.90, and the Root Mean Square of Error Approximation (RMSEA) be less than 0.08).
2. Context of model development: Overall, the model development has accomplished its ultimate goal, which was to asses talent shortage with supply and demand perspective for the shortage of skilled workers among young generation for IBIs.

3. Education Application: The model has derived the important of curriculum development to be aligned with the industrial applied approach. So that the higher education institution alerts the need of update and changes need for their student learning.
4. Contribution to education and community: Sustainable development of talent that keep on relevant together with the rapid changes of industrial 4.0 and Society 5.0. The community benefit the with reducing of unemployment graduates in the market, as the model able play the role in determine supply and demand of talent in the IBIs market.
5. Commercialization: The model can be used by the min Malaysian government is one of the biggest stakeholders to obtain the benefits from this innovation model. The functionality of model would be a benefit for the government, in terms of financial benefit and development, as well as the image of the government. The critical role of the government is to become the policy implementer. With this role held by the government, it has the absolute power to foster the implementation of this model. Two government agencies with this authority are Ministry of Higher Education and Ministry of Finance. These are the ministries that are responsible in implementing the policy for the development of Malaysian Islamic banking graduate and IBIs. Both ministries could derive more holistic blueprint plans in the future, compared to previous MEB and FSB plan. The findings of this study have proven that the government will be able to maintain the balancing strategy between supply and demand function towards Malaysia's talent availability.

Figure 1:Talent Shortage Model

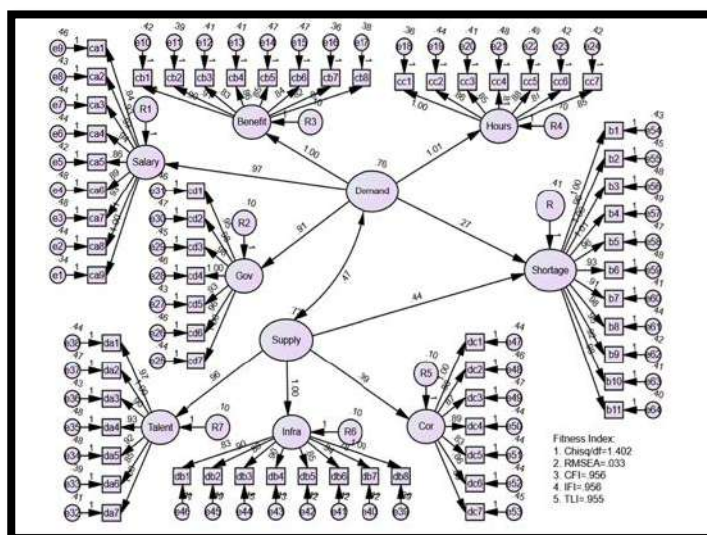

Acknowledgement

This innovation was supported by Ministry of Higher Education with the grant name Fundamental Grants Research Scheme (FRGS) FRGS/1/2020/SS02/UMK/02/2. We thank to our faculty member from University Malaysia Kelantan that provided insight and expertise that greatly assisted the research of this innovation.

References

- Awang, Z. (2014). *A Handbook on SME: For Academicians and Practitioners*. MPWS Rich Resources.
- Aziz, M., Adnan, A., Afthanorhan, A., Foziah, H., Ishak, S., & Rashid, N. (2019). The influence of employer value proposition in talent demand towards talent shortage in the Malaysian Islamic banking institutions: A SEM approach. *Management Science Letters*, 9(6), 843–850.
- Aziz, M. I., Afthanorhan, A., & Awang, Z. (2016). Talent development model for a career in Islamic banking institutions: A SEM approach. *Cogent Business & Management*, 3(1), 1186259.
- Aziz, M. I., Hassan, H., Uthamaputran, S., Merican, R., & Rahim, M. (2021). Modeling Talent Shortage for Entrepreneurship Among Student with Government Policy Support as Mediating Effect: SEM Approach. *The Importance of New Technologies and Entrepreneurship in Business Development: In The Context of Economic Diversity in Developing Countries*, 194, 2011.
- Hair, J. F. (2007). *Research methods for business*.

SUSTAINABLE eHALAL AGROCHAIN MARKETPLACE USING BLOCKCHAIN INNOVATION

Raja Suzana Raja Kasim

Faculty of Entrepreneurship and Business, Universiti Malaysia Kelantan, City Campus,
Pengkalan Chepa, 16100 Kota Bharu, Kelantan
rajasuzana@umk.edu.my

Amir Shafiq Abdullah¹, Zulazli Hashim², Nurul Afiqah Zulazli², Wan Nor Munirah Ariffin³

¹BIT Agro Sdn Bhd

²Universiti Malaysia Kelantan, City Campus, Pengkalan Chepa, 16100 Kota Bharu, Kelantan, Malaysia

³Universiti Malaysia Perlis, Perlis Malaysia

shafiq.abdullah@bit.com.my, zulazli.hashim@gmail.com, fiqazalee@gmail.com, munirah@unimap.edu.my

Highlights: eHalal AgroChain using blockchain innovation enables stakeholders to track all transactions through a trustworthy blockchain network, not only helping to achieve transparency but also to streamline the process and increase global acceptance of Halal Toyiyb products. The problems that we encounter in the Halal Toyiyb ecosystem among others include; the lack of Halal Toyiyb Blockchain specific solution, lack of Halal Toyiyb transparency and the lack of Halal Toyiyb e- marketplace. The elements of our solutions includes smart contracts, Halal Toyiyb inspection certificates, delivery receipts, bank transactions, shipping requests, bill of loading and every other detail is maintained through a centralized blockchain network, enabling the stakeholders to track each stage in real time.

Key words: eHalal, sustainable food supply, Blockchain, technopreneurship, Malaysia

Introduction

eHalal AgroChain using blockchain innovation enables stakeholders to track all transactions through a trustworthy blockchain network, not only helping to achieve transparency but also to streamline the process and increase global acceptance of Halal Toyiyb products.

The problems that we encounter in the Halal Toyiyb ecosystem among others include; the lack of Halal Toyiyb Blockchain specific solution, lack of Halal Toyiyb transparency and the lack of Halal Toyiyb e-marketplace.

The objectives of the platforms are as follows:

- To provide agropreneur and farmer with practical & accessible tools to connect with each other
- To offer a blockchain platform with effective lines of communication in an ethical, and an accountable means of trade
- To offer traceability on the origin of products from farms to fork with responsible stakeholder involved in the supply-chain.

Description of the Innovation

The elements of our solutions as illustrated in Figure 1 includes smart contracts, Halal Toyiyb inspection certificates, delivery receipts, bank transactions, shipping requests, bill of loading and every other detail is maintained through a centralized blockchain network, enabling the stakeholders to track each stage in real time. The blockchain innovation offers a platform that solves business problems by enabling the ecosystem to share information in a trusted manner.

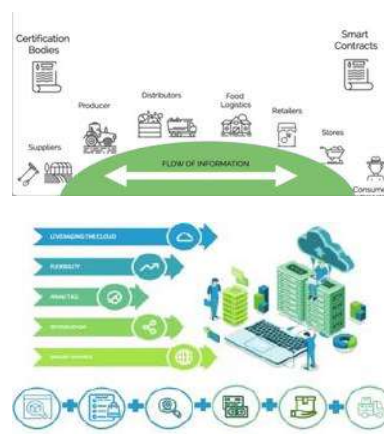

Figure 1: Food supply chain ecosystem and structure

Advantages and Novelty of the Innovation

- An easy to use HALAL Toyib Marketplace that generates HALAL Toyib Market Opportunity for Verified Sellers and Buyers Anytime and Anywhere
- Integrated and Secure Platform with Blockchain Smart Contract & HALAL Toyib Certification
- Transparent and Reliable HALAL Toyib Market Intelligence with Insight.
- HALAL Toyib Traceability with Verification

Novelty, Inventiveness and Inclusivity

- A smart contracts, Halal Toyib inspection certificates, delivery receipts, bank transactions, shipping requests, bill of loading and every other detail is maintained through a centralized blockchain network, enabling the stakeholders to track each stage in real time
- Traceability – important to know where the origin of the food and how it is produced
- Digital Payment – online transfer of money in a secure & transparent way
- Digital Certification – allows the unique certification with set of standards of supply chain
- Cross-border trading – blockchain has the potential to transform the way cross-border trade being transacted
- B2B Digital Marketplace – a B2B digital marketplace where food is made easy, fast & transparent
- Agrotech – use of artificial intelligence and machine learning as a strong focus on data-driven analytical techniques

Benefits to other industries

Key Stakeholders	Process	Blockchain
Input Supplier	Barcode/QR	Initial Data
Producer (Farm)	IoT Sensor	Initial Data + Product Growth
Processor	Certification	Initial Data + Product Growth + Certification
Logistic Distributor	Transport Details	All Data + Transportation Data
Exporter/Importer	QR on Products	All Data + Transportation Data + Location
Consumer	QR Scan	All relevant information



NEW ARRIVAL



FEATURED CATEGORIES



Intellectual Property

Patent has been filed for AI system and methods used in the platform

<p>Patents Form No. 1 PATENTS ACT 1983 REQUEST FOR GRANT OF PATENT (Regulations 7(1))</p> <p>To: The Registrar of Patents Patents Registration Office Kuala Lumpur, Malaysia</p> <p>Application No: Filing Date: Request received on: *Fee received on: Amount: *Charge: Patent Order / Money Order / Demand Draft / Cash</p> <p>Please submit this Form in duplicate together with the prescribed fee</p> <p>Applicant's file reference P12021004089</p> <p>THE APPLICANT REQUESTS THE GRANT OF A PATENT IN RESPECT OF THE FOLLOWING PARTICULARS:</p> <p>I. Title of Invention: ARTIFICIAL INTELLIGENCE SYSTEM AND METHOD FOR SUSTAINABLE SOCIAL FINANCE DATA PREDICTION</p> <p>II. APPLICANT(S) (the data concerning each applicant must appear in this box, if the space insufficient, to the space below): Name: UNIVERSITI MALAYSIA KELANTAN I.C. Passport No.: Address: BAHAGIAN KOMERSIAL DAN HARTA INTELLEK (K/BI), PUSAT PENGUSUSAN PENYELIDIKAN DAN INOVASI, PLAZA TERAJUM, SAIB CANELOS, JENALAN PERSEKUTUAN & PERDANA, UNIVERSITI MALAYSIA KELANTAN, 36000 BACHOK, KELANTAN. Address for service in Malaysia: SAME AS ABOVE Nationality: MALAYSIAN *Permanent residence or principal place of business: Telephone Number (if any): Fax Number (if any):</p>	<p>Patents Form No. 1 PATENTS ACT 1983 REQUEST FOR GRANT OF PATENT (Regulations 7(1))</p> <p>To: The Registrar of Patents Patents Registration Office Kuala Lumpur, Malaysia</p> <p>Application No: Filing Date: Request received on: *Fee received on: Amount: *Charge: Patent Order / Money Order / Demand Draft / Cash</p> <p>Please submit this Form in duplicate together with the prescribed fee</p> <p>Applicant's file reference P12021004088</p> <p>THE APPLICANT REQUESTS THE GRANT OF A PATENT IN RESPECT OF THE FOLLOWING PARTICULARS:</p> <p>I. Title of Invention: HUMAN INTELLIGENCE PERFORMANCE PREDICTION BASED ON AI METHODS</p> <p>II. APPLICANT(S) (the data concerning each applicant must appear in this box, if the space insufficient, to the space below): Name: UNIVERSITI MALAYSIA KELANTAN I.C. Passport No.: Address: BAHAGIAN KOMERSIAL DAN HARTA INTELLEK (K/BI), PUSAT PENGUSUSAN PENYELIDIKAN DAN INOVASI, PLAZA TERAJUM, SAIB CANELOS, JENALAN PERSEKUTUAN & PERDANA, UNIVERSITI MALAYSIA KELANTAN, 36000 BACHOK, KELANTAN. Address for service in Malaysia: SAME AS ABOVE Nationality: MALAYSIAN *Permanent residence or principal place of business: Telephone Number (if any): Fax Number (if any):</p>
---	--

Letter of Intent from Industry

LETTER OF INTENT (LOI) BETWEEN
PROF. DR. Hjh. RAJA SUZANA RAJA KASIM,
UNIVERSITI MALAYSIA KELANTAN,
AND
AMIR SHAFIQ ABDULLAH
BIT AGRO Sdn. Bhd.

Professor Dr. Hjh. Raja Suzana Raja Kasim from Universiti Malaysia Kelantan, and Amir Shafiq Abdullah from BIT Agro Sdn. Bhd. agree to cooperate in the application of MALAYSIA TORAY SCIENCE FOUNDATION Grant for the research project entitled:

SUSTAINABLE (HALAL) AGROCHAIN MARKETPLACE USING BLOCKCHAIN INNOVATION
headed by:
Professor Dr. Hjh. Raja Suzana Raja Kasim

- The implementation of the research project of this LOI shall be negotiated and determined by both parties. For the purpose of implementing the co-operation in respect of any areas stated in the research proposal, the Parties will negotiate and conclude legally binding agreements ("Definitive Agreements") containing mutually agreed terms and conditions suitable to the implementation of such co-operation.
- The full autonomy of either party shall not be diminished, nor shall any controls be imposed on carrying out this LOI.
- This LOI shall be in force for the whole duration of the research project as stated in the research proposal and shall be subject to revision or extension by mutual agreement. This LOI may be terminated by either party by written notice of no less than six months prior to desired termination date.
- This LOI is written in English and shall come into effect from the last date of signing. Each organization shall retain one copy with both signatures.

The undersigned being duly authorized thereto, have signed this Letter of Intent (LOI) on this 27 May 2021.

For: Universiti Malaysia Kelantan Signature: Professor Dr. Hjh. Raja Suzana Raja Kasim Professor of Entrepreneurship Date: 27 May, 2021	For: BIT Agro Sdn. Bhd. Signature: Amir Shafiq Chief Executive Officer Date: 27 May, 2021
--	--

MyIPO: LY2019000515

<p>MyIPO PERBADANAN HARTA INTELLEK MALAYSIA Intellectual Property Corporation of Malaysia</p> <p>Payment Slip</p> <p>Application Number: LY2019000515 Application Fee: CR-1 NOTIFICATION OF WORKS Title of Work: CORE-STEM EDUCATION AND LEARNING Type of Work: LITERARY Filing Date: 20/02/2019 Applicant Name: UNIVERSITI MALAYSIA KELANTAN Work Deposit Type: Document No. of Pages: 2 Copyright Work Fee (RM): 10 CR-1 Fee (RM): 15 Total (RM): 25</p>	<p>PERBADANAN HARTA INTELLEK MALAYSIA INTELLECTUAL PROPERTY CORPORATION OF MALAYSIA</p> <p>RECEIPT</p> <p>Application No: LY2019000515 Filing Date: 20/02/2019 Applicant Name: UNIVERSITI MALAYSIA KELANTAN Work Deposit Type: Document No. of Pages: 2 Copyright Work Fee (RM): 10 CR-1 Fee (RM): 15 Total (RM): 25</p>
--	---

MyIPO: Copyrighted Modul entrepreneurship development

- Module on Programming Algorithm for Agrochain
- Module for Machine Learning in Agrochain
- Module for Data Analytic Fundamentals in agrochain
- Package for AI for non-AI: creating AI STEMpreneur

Commercialisation values

- The commercialisation values offer a return on investment in support of green technologies in Industry 4.0 to B2B, B2G and B2C.
- Ministry of Agriculture: preparing market in particular micro SME enterprises to meet their financial reporting challenges.
- Ministry of Education: Malaysia will benefit sufficient number of qualified trainers in meeting the industry 4.0 talent to grow.
- Ministry of Women & Family Development: mainstreaming women (gender) participation in support of growing new entrepreneur
- UA/schools/audit centers: prepare human capital, workforce, future social entrepreneurs, students, graduates with the automatic analysis of financial statement with creativity, innovative and problem-solving skills to meet the science and green technology challenges.

Business Model

1. B2B (Industry) and B2C (consumer)
 - Consulting solutions pay per professional services (depends on large datasets)
 - Feature such as designed and collect consumer data
2. B2G (education)
 - Pay per use - digitally delivered with Access Code and innovative curriculum for blockchain technology

References

- Aspiranti, T., Amaliah, I., Mafruhah, A.Y., Kasim, R.S.R (2020), Dynamic behaviour model. Polish Journal of Management Studies. DOI: 10.17512/pjms.2020.22.1.04
- Yudha Dwi Nugraha, Raja Suzana Binti Raja Kasim, Tasya Aspiranti, Nunung Nurhayati, and Ima Amaliah, (2020), How does the government boost the entrepreneurship community in Entrepreneurial Ecosystem in Higher Education. India, Lucknow: Epyreal Publishing House, p. 8-22.
- Hanieh Alipour Bazkiaei, Low Hock Heng, Noor Ullah Khan, Roselina Binti Ahmad Saufi & Raja Suzana Raja Kasim (2020). Do entrepreneurial education and big-five personality traits predict entrepreneurial intention among universities students? Manuscript DOI: 10.1080/23311975.2020.1801217 (IF: 0.860), Journal: Cogent Business & Management
- Raja Suzana Raja Kasim, Fakhhar Shahzad and Wan Suzanna Aafanii Adeeba Binti Wan Ibrahim (2020) COVID-19 Impact on Business Sustainability: A Case of Micro-Small and Medium Enterprises in Malaysia. Horizon J. Hum. & Soc. Sci. 2 (S): xx-xx, <https://horizon-jhssr.com/current-issue.php> (2020)
- Raja Suzana Raja Kasim, Fakhhar Shahzad (2020). Unveiling the adverse effect of late-night use of social media on female' entrepreneurial cognitive engagement: a stressor-strain-outcome perspective (IJEER-04-2020-0256). <https://www.frontiersin.org/Frontier in Psychology> (Scopus)
- Raja Suzana Raja Kasim, Zulazli Hashim, & Zainudin Awang (2017). Social innovation and its influence on youth startup: the marginalised communities in malaysia. PERTANIKA Journal Of Social Science & Humanities (JSSH), 25(S), 89-98.
- Raja Suzana Raja Kasim, Zainudin, Awang, & Zulazli Hashim (2017). Keusahawanan dan inovasi sosial: ke arah penjanaan semula pembangunan generasi muda yang positif. In Raja Suzana R.K., & Samsudin, A.R., (Ed.), Generasi muda komuniti terpinggir: kearah penjanaan semula pembangunan generasi muda. (Pp. 87-121). Kota Bharu, Kelantan: Penerbit Universiti Malaysia Kelantan
- Raja Suzana Raja Kasim, & Zulazli Hashim (2018). Pemeiksaan keusahawanan generasi muda komuniti terpinggir lulusan TVEI dalam menangani cabaran arus industri 4.0 ke arah negara maju. In Raja Suzana R.K., & Samsudin, A.R., (Ed.), Generasi muda komuniti terpinggir: kearah penjanaan semula pembangunan generasi muda. (Pp. 145-169). Kota Bharu, Kelantan: Penerbit Universiti Malaysia Kelantan.

MAPPING OF TOURISM IN JELI, KELANTAN THROUGH AUGMENTED REALITY (AR) APPLICATION

Norazlinda Mohamed Rosdi

Faculty of Creative Technology & Heritage, Universiti Malaysia Kelantan, 16300 Bachok, Kelantan, Malaysia.
norazlinda@umk.edu.my

Daeng Haliza Daeng Jamal¹, Max Martin Petel¹, Hazrina Hasbolah²

¹Faculty of Creative Technology & Heritage, Universiti Malaysia Kelantan, 16300 Bachok, Kelantan, Malaysia.
haliza.j@umk.edu.my, martin.c18a0097@siswa.umk.edu.my

²Faculty of Entrepreneurship and Business, Universiti Malaysia Kelantan, 16300 Bachok, Kelantan,
Malaysia.hazrina.h@umk.edu.my

Highlights: The existence of nature beauty is one of the graces that exists in Malaysia and because of that, Malaysia in general become the most preferable destination for tourist vacation spot. The government and relevant agencies play a significant role in promoting and introducing Malaysia to the rest of the world. Parallel with any of kinds of promotions, it will not only generate national income yet open up eyes of various parties to develop areas that have big potential for tourism best destinations through the improving of existing services and creating new tourism products. Nevertheless, it seems that less initiative has been put into consideration for alternative measures by tourism parties, preferably Kelantan such as providing information platforms or virtual visits in an effort to attract visitors across the world in line with the development of the 4.0 industry revolution. This seen as a loss in the tourism sector, including in Kelantan. Thus, to cope with that, the application of Augmented Reality seen as one of the best approaches. As for this study, the researcher chose the development in Jeli area by looking at the existing attractions available which potentially to be developed and then analyse the potential of the tourism industry in the area through the Augmented Reality Application. Among the attractions in Jeli area that are often attracting the tourists are Lake Pergau, Jeli Orang Asli Museum, Lata Janggut Waterfall, Lata Keding, Lata Renyok, Bukit Kudung, Bukit Noring Timur, Bukit Noring, Bukit Basor and Bukit Reng as well as Bukit Bunga shopping spots. In addition, Jeli also has attractive resorts and chalets, one of which is known as the Bukit Kudung Resort. Throughout this study, apart from making Jeli as one of the alternatives to the community, especially the stakeholders involved in tourism development, it can also be used as one of the major reference sources for future researchers.

Keywords: *Cultural Mapping, Attraction, Tourists, Income Generation, Augmented Reality, 4.0 Industry Revolution.*

Introduction

Tourism defined as an activity of traveling, visiting, or traveling to another place where the distance is approximately 50 miles away from the place of residence for recreational purposes or to fill leisure time with not more than one year within the country or internationally. According to the United Nations (UN), tourism refers to the service activities for tourists, accommodating and entertaining tourists as well as an operating business. It is not only limited to tourism activities because people sometime will move away and live in a place outside their normal environment for leisure time, business and other purposes. Malaysia is a country that rich with the various natural resources. The majestic and peaceful beauty of the mangrove hills is also one of the country's imperative assets in an effort to attract more foreign and local tourists to visit, stay, and make Malaysia as their main vacation spots. However, the tourism sector have existed for a long time ago but still lacking and needs such effort of enhancement so that it is better known by all regardless of whether local tourists or foreign tourists. The government and related agencies need to actively participate in promoting and introducing Malaysia to the rest of the world. For instance, among the exertions that have been made is Visit Malaysia Year, Visit Kelantan Year, International Wau Festival and other festivals that enable to encourage the presence of more tourists.

Content

The name of Jeli comes from the root of a hill. In fact, some even stated that it was taken from the abbreviation of the name Jeli District Council. Jeli was originally a small colony established on 1 July 1982 from a combination of Tanah Merah and Kuala Krai colonies with a population in 2020 of 55,353, representing 2.78% of the total population of Kelantan. Jeli District has an area of 1,636.21 square kilometres and is the third largest area in Kelantan covers several mukims and villages such as Mukim Jeli, Kampung Berdang, Kampung Teluk Bayu, Kampung Gemang, Kampung Lakota, Kampung Sungai Satan, Kampung Legeh, Kampung Seberang Jeli, and Kampung Pasir Dusun. There is even an aboriginal village located in Kampung Sungai Rual. The focus of Jeli's development is to make "Jajahan Jeli, Jajahan Sejahtera" with a focus towards the development as the centre of comprehensive educational institutions and then integrated into leadership development, implementation of Islamic law, educational development, economic development, administrative development, and socio-cultural development.

Additionally, one of the industries that contribute a lot to income and economic development in Jeli is the tourism industry. Among the attractions in Jeli area that are frequently attract most of the tourist's attention are Lake Pergau, Jeli Orang Asli Museum, Lata Janggut waterfall, Lata Keding, Lata Renyok, Bukit Kudung, Bukit Noring Timur, Bukit Noring, Bukit Basor and Bukit Reng as well as the Bukit Bunga shopping spots. In addition, Jeli also has fascinating resorts and chalets and one of them is Bukit Kudung Resort. Apart from the waterfall, the main attractions of this resort are the windmill tower and the monument "I Love Bukit Kudung Jeli" located in front of the resort. In fact, the resort also has a "love" shaped spring pool that can make visitors fascinated by the natural beauty of the area. However, tourism in Jeli is seen to receive less attention from visitors because of the lack of initiatives on alternative measures such as providing information platforms or virtual visits in attracting visitors in line with the development of the 4.0 industry revolution. It is seen as a loss to the tourism sector in Kelantan.

As such, the application of Augmented Reality approach is seen as one of the best tools in addressing the issue. This Augmented Reality application works through 3D video and audio which virtually bring about a person to feel the real experience of being in a situation or place even if they are not physically in that situation or place. This approach must be given sufficient emphasis because it is one of the investments that can drive the economic growth of the state, Malaysia in general in line with other industries. This is because the development of a tourism industry does not only depend on advertising and great promotions, but it is also closely related to the implementation methods that utilize technology in line with the 4.0 industry revolution.

References

- Bukit Kudung simpan seribu khazanah alam, sejarah (2019, 06 Oktober). Sinar Harian Dijangka lebih 10,000 Pelancong Masuk Kelantan: Exco. (2020, 12 Disember). Utusan Sinar Harian
- Ibrahim, J. A., & Ahmad, M. Z. (2012). Perancangan Dan Pembangunan Pelancongan. UUM Press.
- Kolam 'Love' Tambah Pesona, (2020, 25 Jun). MyMetro
- Razali, M. K., Ahmad, H., Jusoh, H., & Choy, E. A. (2017). Place-making dalam Agenda Pembangunan Pelancongan (Place-making in Tourism Development Agenda). Geografia-Malaysian Journal of Society and Space, 13(1).

MY ESCAPEDE! APPS: EXPLORING ADVENTURE TOURISM DESTINATION

Siti Nur Farhana Dzulkipli

Faculty of Hospitality, Tourism & Wellness, Universiti Malaysia Kelantan, Kelantan, Malaysia
farhana.h18b0590@siswa.umk.edu.my

Nor Azwani Anuar, Zahidah Mad Loddin, Roslizawati Che Aziz & Nik Alif Amri Nik Hashim

Faculty of Hospitality, Tourism & Wellness, Universiti Malaysia Kelantan, Kelantan, Malaysia
azwani.h18b0316@siswa.umk.edu.my, zahidah.h18a0677@siswa.umk.edu.my, roslizawati@umk.edu.my

Highlight: My Escapade! app is an education app that will come out with the information and education regarding the adventure tourism in Malaysia by targeting domestic and international travellers as the potential users. This apps will provide the information needed about the visitor attractions specifically in adventure tourism in Malaysia. With My Escapade! app, it will assist users especially for adventurous travellers to get related information besides can gain new experience. More importantly, the app is expected to make a better contribution for all users to understand and explore about adventurous destination in Malaysia.

Key words: *Adventure tourism, tourist destination, education application, young travellers, My Escapade*

Introduction

As travellers seek new and different experiences, adventure tourism continues to grow in popularity. Adventure tourism is a tourist activity that includes physical activity, a cultural exchange, or activities in nature. It is about connecting with a new culture or a new landscape and being physically active at the same time. It is not about being risky or pushing your boundaries. As we know, adventure tourism is one of the fastest growing sectors in the tourism industry which it is one of the most important categories marketed and promoted globally. However, the way adventure tourism is represented and perceived differs markedly from one culture to another. Based on how tourism is conceptualized in a particular culture, themes are carefully selected and exploited to help educating and revealing the concept and element to the people about the adventure tourism. Realizing the important and the demand of the adventurous activities domestically and internationally, thus the My Escapade! Apps was developed to fill the gaps in this industry.

My Escapade! is a mobile application that will be produce with the aim to enhance the functionality of the previous system. This application is develop based on the issues from the previous mobile application system that tourists only know about the famous adventure places only. Malaysia has high potential to continue to thrive in the context of adventure tourism if appropriate steps are taken. This means that most teenagers do not know clearly what products and adventure tourism destinations are available in the country. In fact, it is especially important to know and respect participant limits while we are in an unfamiliar area. Our list of adventure tourism activities has plenty of options if we aren't necessarily a thrill seeker. If we are an adrenaline junkie, don't worry as My Escapade apps still have a few ideas for next trip. This is the advantages of this apps where with this, My Escapade apps can promote and educate people about the adventurous destinations that available in Malaysia besides they can explore any activities that available at the tourist attractions.

While travellers are now more likely to travel further afield, so My Escapade apps also allows them to feel confident about their destination before travelling, the suitability of destination photos and guides. Through this apps, the QR code also provided as a feature to make user feel comfortable and easy to access the location and activities provided. With the development of this application, it can support the policy created by the government in National Tourism Policy 2020 -2030 which it can help in contributing and disseminating the knowledge to the Malaysians on more in -depth regarding the adventure tourism in Malaysia.

Background of the project



app is an education app that will come out with the information and education regarding the adventure tourism in Malaysia by targeting domestic and international travellers as the potential users. This apps will provide the information needed about the visitor attractions specifically in adventure tourism in Malaysia. With My Escapade! app, it will assist users especially for adventurous travellers to get related information besides can gain new experience. More importantly, the app is expected to make a better contribution for all users to understand and explore about adventurous destination in Malaysia.

The objective of this project is to help in contributing and disseminating the knowledge to the Malaysians on more in depth by educating or revealing the concept or element about the adventure tourism in Malaysia. Besides that, the project also aim to promote the adventure tourism in Malaysia because this app will provide the place of a niche product that will make them easy to find and make a choice to bring a group of students to do some activities at the same time they also can know more about the tourism. It is also will provide the user a feedback section where they can give any review about the places the go to and how this app helping them. The QR code feature, where the users can easily scan the code to get a direct info about some places or activities are also provided. My Escapade! App will introduce users to the nature view of the mountain or hill that they can learn and see themselves hence it also contain education elements of adventure tourism in Malaysia to make it easy for user to search and travel.



Picture 1: The prototype of the My Escapade! Apps

It is a place where users can post short stories and images that give more details to a trip or activity. It's almost a micro-blogging platform with community features. Users also can follow friends and influencers as they travel and meet travel mates based on users' location. My Escapade! Apps is developed as a new kind of adventure tourism app that helps travellers track down interesting and exciting activities across Malaysia. While there are many apps available to help users to plan their next trip, there is often an overwhelming amount of information to sort through. My Escapade! helps to narrow down the search by handpicking unique and affordable tourist experiences. It is also working with a team of seasoned travellers and local experts to find the best experiences and highest-quality activities. Some of the many activities available include white water rafting, hiking, and mountain climbing. While these activities may seem extravagant, the My Escapade! team works directly with communities to benefit local operators and support responsible forms of tourism. Not only are the activities exhilarating and exciting, they are also extremely affordable because My Escapade! guarantees the most thrilling experience for adventurous travellers.

Richards (2010) in his UNWTO report stated that youth travel has become an increasingly important part of the global tourism industry in recent decades, as more young people have begun to travel more frequently and over greater distances. Nowadays, youth travellers are enjoying more on travelling rather than other generation as they love to experience new things. Because of that, it has made that youth travel is one of the attractive and fastest growing market in tourism industry. Today's traveller attitude towards holiday is positive due to easy accessibility to gather information and purchasing tourism product through online and economical transportation cost. To sum up, travelling has become convenient and more affordable than it was before. According to study by Aminudin, Soumin, Razak, & Tarmud (2017), it was identified that the factor that influenced them to travel to a certain place is due to the source of information provided. So, we believe that with the innovation that will be provided by our application, it can be sold and introduced at a higher level and internationally.

Developing process of apps

The main point of consideration to get started is the type of application to be built. Make sure this app is specifically for teens and students. User stories should be designed appropriately and the flow of applications can help meet the main goals of educational application development. In depth knowledge of the eLearning market will help develop applications that serve users in the best way. Good research will provide insight into competitor applications, and contribute to filling existing gaps. Information on the problems faced by users through a thorough study of the available educational applications will be of great help. A focus on technologies that help meet specific needs is necessary to refine what tools will be utilized for development of apps.

Benefits

As we all know that today's generation like to spend their time on mobile. It's not necessary that what they are going to use but they love to use mobile apps like shopping, entertainment, game or learning-based apps comparatively anything else. Students usually doesn't like study. But if we connect their boring activities into interactive activities then they will love to study. With education apps, it can help to improve the education system, where it will make easier for students to learn new things.

As the education app is easier to understand and faster to use as compared to books and websites. The user can get everything more depth regarding the information about the Malaysia's adventure tourism in their pocket where they only just need to use their phone to get all those information and knowledge. Besides, by using this application, user also can go paperless and help to save the environment as the travellers may forget the itinerary. But when they have this app, they don't need to worry about it anymore. As a leading-edge technology, My Escapade! app is custom built for each trip, providing users all the information they need. For enhanced safety, My Escapade! app includes safety information which allows them to use it as a guideline before they going to do their activities.

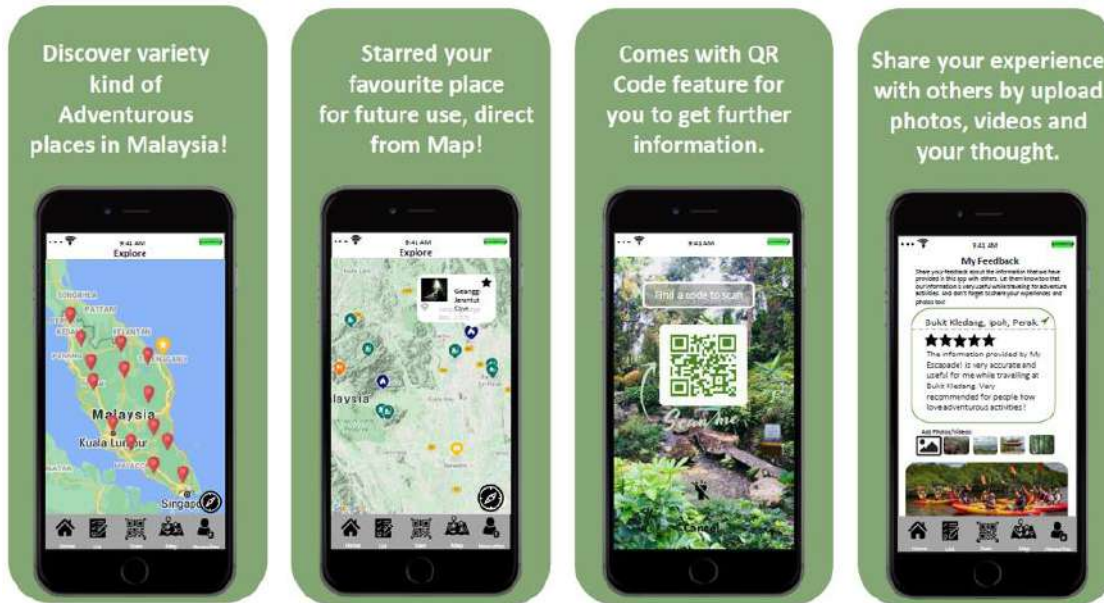

Picture 2: The information in My Escapade! Apps

Commercialization value

Youth travellers had been said that they commonly have high interest and leisure time in exploring new destinations though they are restricted by relatively low levels of disposable income (Yusof, & Ting, 2015). Today's traveller attitude towards holiday is positive due to easy accessibility to gather information, and purchasing tourism product through online and economical transportation cost. To sum up, travelling has become convenient and more affordable than it was before. According to study by Aminudin, Soumin, Razak, & Tarmud (2017), it was identified that the factor that influenced them to travel to a certain place is due to the source of information provided. So, we believe that with the innovation that will be provided by our application, it can be sold and introduced at a higher level and internationally.

Acknowledgement

Many thanks to the Almighty for his blessings on the successful completion of our innovation competition. My sincere gratitude to our mentor for sharing knowledge and assisting us in finishing our project. Apart from that, we are very thankful to our loving family members especially my parents who has helped us in terms being a pillar of our strength while carrying out the project. Finally, our gratitude and appreciate go out to all those who had been involved in preparing this My Escapade! app directly or indirectly.

References

- Aminudin, N., Soumin, J., Razak, I. R., & Tarmud, S. (2017). Effect of information source on Sabah destination image and non-visitors' behavioral intention. *Journal of Tourism, Hospitality & Culinary Arts*, 8.
- Richards, G., & Wilson, J. (2004). Motivations and Behaviour of Independent Travellers Worldwide. *The Global Nomad: Backpacker Travel in Theory and Practice*. Clevedon: Channel View Publications, 14- 39.

ULAM COOKIES

Derweanna Bah Simpong

Faculty of Hospitality, Tourism and Wellness, UMK
derweanna@umk.edu.my

**Nur Azimah Othman¹, Normaizatul Akma binti Saidi¹, Hazzzyati binti Hashim¹, Nadzirah binti Mohd Said²,
Wan Farha binti Wan Zulkiffli²**

¹Faculty of Hospitality, Tourism and Wellness, UMK

²Faculty of Entrepreneurship and Business, UMK

azimah.o@umk.edu.my, akma.s@umk.edu.my, hazzzyati@umk.edu.my, nadzirah.ms@umk.edu.my,
farha@umk.edu.my

Highlights: The aim of this project is to create and introduced the cookies that made of traditional vegetables or known as ulam as the natural flavouring. Ulam is the traditional vegetables which are normally consumed in a raw form among South East Asian populations. Ulam are rich in carbohydrates, proteins, minerals, and vitamins. In Malaysia ulam are popular and they are considered the most economical vegetables available throughout the year. However, their application in processed foods for enhancement of nutritional characteristics are still limited. Knowing bakery products such as cookies are the better vehicles for fortification. Therefore, this project was carried out to (1) produce healthy cookies made of ulam, (2) proposed a suitable formulation for the ulam into cookies by considering at the texture and taste, (3) introduce the cookies that made from ulam into the local market.

Keywords: *Ulam, Cookies*

Introduction

The amazing healing power of Malaysian herbs is often overlooked. Many of us would by-pass the *ulam* section at a buffet and miss out on the natural healing powers of these unassuming local herbs. Ulam are rich in carbohydrates, proteins, minerals, and vitamins. Normally *ulam* is consumed in a raw form among South East Asian populations such as in Indonesia, Thailand, and Malaysia and it is also eaten together with rice and another accompaniment such as *budu*, *cincaok* or *sambal* (Huda-Faujan et al. 2007; Reihani & Azhar 2012). On average, Malaysian adults consumed 40 g/person/day of ulam and it tends to increase the serum of Vitamin C, E, folic acid, β -carotene, and lycopene (Nurul Izzah et al. 2012). However according to National Health & Morbidity Survey by the Ministry Health Malaysia (MOH) (2015) reported that, 94% of the population in this country do not take vegetables in sufficient quantities, based on recommendations by World Health Organization (WHO). Nevertheless, Lembaga Pemasaran Pertanian (FAMA) through their campaign *Lebihkan Makan Ulam* has encourage more people especially young generation to consume ulam in their daily life (Sinar Harian 29 Jun 2020).

Ulam Cookies

Cookies have become one of the most desirable snacks for both young and elderly people due to reasonably cheap cost, more convenience, long shelf-life, and ability to serve as a vehicle for important nutrients. Usually, the main ingredients for making cookies are wheat flour, fat, sugar, water, while other ingredients such as milk, salt, aerating agent, emulsifier, colour, and flavour can be included (Jeantet, Croguennec, Schuck & Brulé 2016). Since consumers are much more concerned about their health and demand the food products conferring health benefits, they tend to look for the products that are more natural-like (Amin, Bashir, Dar & Naik, 2016). It is scientifically show that, *ulam* has potential as food that could bring health benefits to the consumer (You, Shahr, Haron & Yahya 2018). Within Asian countries, more than 120 species of ulam have been discovered, and it is including *Ulam raja* (*Cosmos caudatus*), *Pegaga*, (*Centella asiatica*), *Kacang botol* (*Psophocarpus tetragonolobus*), *Pucuk gajus* (*Anacardium occidentale L.*) and many more. For this project these four types of ulam has been chosen as the additional ingredients for making cookies.

Figure 1.1: *Cosmos caudatus*



Cosmos caudatus or *ulam raja* originated from Latin America but can be found growing wild around Malaysia. They can grow to a height of 2 meters from seeds found in the dried flowers. The part of the plant that is normally eaten is the young shoots. The health benefits of eating *ulam raja* are that is said to clean the blood of toxic materials and can also strengthen bones (You, Haron, Shahar & Yahya 2018)

Figure 1.2: *Centella asiatica*



Centella asiatica or *pegaga* grows in relatively moist soil. It originated from India but can easily be found anywhere in South East Asia. It is rebuilding the energy, helps to reduce stress and increase mental power. It is said be able to reduce high blood pressure, slow down ageing process, and help the body protect itself against toxins (You, Haron, Shahar & Yahya 2018)

Figure 1.3: *Psophocarpus tetragonolobus*



Psophocarpus tetragonolobus or known as *kacang botol* are a complete package. Its leaves, stems, flowers, seeds, tubers, are all edible in some way or the other. This veggie is packed with nutrition and offers us a number of benefits. This *ulam* are rich source of protein, vitamins A and minerals. The high dose of antioxidant present in this bean ensures that the skin maintains its elasticity and keeps it looking young (You, Haron, Shahar & Yahya 2018).

Figure 1.4: *Anacardium occidentale L.*



Anacardium occidentale L. or *pucuk gajus* is an evergreen tree that is native to North Eastern Brazil and is sophisticated in various tropical countries. The tree produces edible fruits with nuts which are widely consumed as a food. It belongs to Anacardiaceae family (You, Haron, Shahar & Yahya 2018).

Methodology

This project involves the lab test, it is necessary to see the various effects on each ingredient until get the right formulation. Therefore, sensory evaluation is needed each time of the lab test. This project is using the hedonic rating scales from range 1 to 5, dislike extremely to like extremely. In this project *ulam* is the additional ingredients in these making *ulam* cookies. It is undergoing the drying process in the oven at 140°C for 20 minutes.

Product Formulation of *Ulam* Cookies

The basic formulation (Table 1.1) was modified from brown sugar, butter, eggs, vanilla extract, salt, baking soda, flour and 11.4% (100gm) dried mix *ulam*. These formulations were modified to obtain the taste and texture to suit the developed product.

Table 1.1: Formulation of *ulam* cookies

	QUANTITY	PERCENT
Brown sugar	250 gm	28.4%
Butter	100gm	11.4%
Eggs	100 gm	11.4%
Vanila extract	10 gm	1.14%
Salt	10 gm	1.14%
Baking soda	10 gm	1.14%
Flour	300 gm	34%
Ulam Mix	100 gm	11.4%
Batch size	880 gm	100%

Techniques and Process of Making *Ulam* Cookies



	<ul style="list-style-type: none"> • Weight the <i>ulam</i> into 500gm each of them. • Slices them and wash thoroughly the running water. • Place the <i>ulam</i> in the food dehydrator 70°C for 12 hours. • After it completely dry, grind it into a mixture.
	<ul style="list-style-type: none"> • Measure all the ingredients. • Beat the butter and sugar, add in the eggs, then add in the flour and <i>ulam</i> mixture. And mix until well combined.
	<ul style="list-style-type: none"> • Preheat the oven to 180°C for 5 minutes. • Spray the baking try with the cooking spray. • Drop the cookies dough on the baking try 10gm each. • Baked the dough for 20 minutes or until it is golden brown. • Transfer the cookies into cooling rack for cooling process.

Table 1.2 : Hedonic Rating Scales

Product Sample	Ratings				
	1 Dislike extremely	2 Dislike Moderately	3 Neutral	4 Like Moderately	5 Like extremely
Taste	0	1	6	5	5
Sweetness	0	0	1	13	3
Texture (Crunchiness)	0	0	3	8	4
Colour	0	2	7	4	4

From the mean score for the third result show the highest mean for the taste, sweetness, texture (crunchiness) and colour of the *ulam* cookies. Whereby all 17 respondents were accepted the taste, sweetness, texture, and colour of the *ulam* cookies.

Figure 1.5: Mean scores graph for of *ulam* cookies

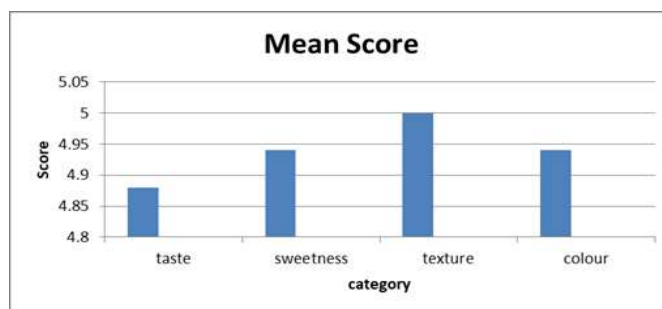
Based on the Figure 1.5 shows that the mean scores by respondents of *ulam* cookies. The mean for texture is 5.0, it show that most of the respondent like the texture of the cookies with, meanwhile the mean for sweetness and colour is 4.94, it show that, the respondent can accept the sweetness and the colour of the *ulam* cookies. Lastly mean score for the taste is 4.88 it shows that respondents are less likely the taste of the cookies.

Product Flow

This section shown the product flow from the first stage until the final stage. It involved four stages; the first stage is called beginning stage. During this stage the ingredients are go through selected procedure and cleaning process. Only the good quality of *ulam* are been selected during this stage. The core reason is to avoid unexpected effect to the product. Second stage is drying It involved all types of *ulam-ulam* by using food dehydrator machine at 70°C for 12 hours. The third stages are cookies making, whereby all the ingredients are measure, and mix into the cookie's dough. The last stage is packaging, the cookies is measured into 100gm for each of the packaging.

Figure1.6 : Production Flow

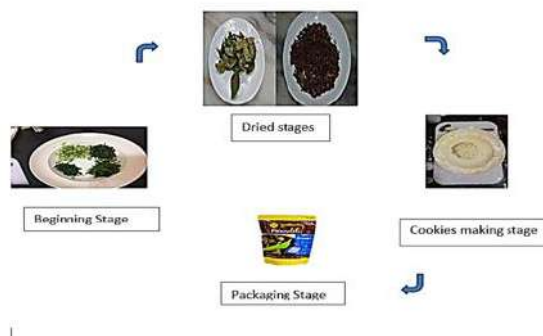

Conclusion

The use of the dried *ulam* as the natural flavouring in cookies production improve the properties of the cookies itself. Whereby most of the respondent can accept the texture, taste, colour, and sweetness of this cookies. The products may very well serve the functional food industry.

References

- Abas, F., Shaari, K., Lajis, N. H., Israf, D. A., & Kalsom, Y. (2003). Antioxidative And Radical Scavenging Properties of The Constituents Isolated from *Cosmos Caudatus* Kunth. *Natural Product Sciences*, 9(4), 245-248.
- Huda-Faujan, N., Noriham, A., Norrakiah, A.S. & Babji, A.S. 2007. Antioxidative Activities of Water Extracts of Some Malaysian Herbs. *International Food Research Journal* 14(1): 61-68.
- Jeanter, R., Croguennec, T., Schuck, P., And Brulé, G. (Eds.). (2016). *Handbook Of Food Science and Technology 1: Food Alteration and Food Quality*. John Wiley & Sons.
- Nurul Izzah, A., Aminah, A., Md Pauzi, A., Lee, Y.H., Wan Rozita, W.M. & Fatimah, S. 2012. Patterns Of Fruits and Vegetable Consumption Among Adults of Different Ethnics in Selangor, Malaysia. *International Food Research Journal* 19(3): 1095-1107.
- Shui G, Leong LP, Wong SP. Rapid Screening and Characterisation of Anti-Oxidants Of *Cosmos Caudatus* Using Liquid Chromatography Coupled With Mass Spectrometry. *J Chromatogr B Analyt Technol Biomed Life Sci*. 2005;827:127-38.
- Su LJ, Arab L. Salad and Raw Vegetable Consumption and Nutritional Status In The Adult US Population: Results From The Third National Health And Nutrition Examination Survey. *J Am Diet Assoc*. 2006;106:1394-404.
- Sinar Harian 29 Jun 2020. *Kempen Lebihkan Makan Ulam*. Retrieved From <http://www.fama.gov.my/Documents/20143/306550/29+Jun+2020+-+Kempen+Lebihkan+Makan+Ulam>.
- You, Y. X., Shahar, S., Haron, H., Yahya, H. M., & Din, N. C. (20). High Traditional Asian Vegetables (*Ulam*) Intake Relates to Better Nutritional Status, Cognition and Mood Among Aging Adults from Low-Income Residential Areas. *British Food Journal*.

MALAYSIAN TREE SELECTION MODEL FOR RIGHT TREE SPECIES

Ramly Hasan

Faculty of Architecture and Ekistics, University Malaysia Kelantan,
Bachok Campus, 16300, Bachok, Kelantan, Malaysia
ramly.h@umk.edu.my

Nor Hamizah Abdul Hamid, Wan Saiful Nizam Wan Mohamad, Noorliyana Ramlee

Faculty of Architecture and Ekistics, University Malaysia Kelantan,
Bachok Campus, 16300, Bachok, Kelantan
norhamizah@umk.edu.my, saifulnizam@umk.edu.my, liyana.r@umk.edu.my

Highlights: The Malaysian tree selection model identifies the site factors, social factors, institutional factors, limiting factors, economic factors and tree characteristics factors of roadside tree species selection. As part of the tree species selection based on institutional factors mentioned in Roy's (2014) model, the researchers have included landscape policies, decision makers, framework and plan of the proposed roadside tree species as reported by Malaysian landscape architects. The researchers added a new factor to the model, namely limiting factors which comprise space and location. These elements influence the selection of tree species as reported by landscape architects, where the limiting space and location features affect tree growth.

Key words: *tree selection model, tree characteristics, landscape architects, tree growth*

Introduction

Urban trees are living organisms and vital elements of a city's infrastructure; thus, they should be considered at every stage of planning design and development. In Malaysia, rapid changes in the environment have indirectly influenced the roadside tree condition such as fallen trees. This is reflected with the statistic increment of public complaints by 39% from 2014 until 2016 regarding the roadside tree problems, which are very worrying for the local authorities. This study aims to develop a Malaysian Roadside Tree Species Selection for guidance in selecting the right tree species for a sustainable city. The objectives of this study are (i) to determine additional attributes in roadside tree species selection, (ii) to examine the relationship between existing and additional attributes and (iii) to develop a Malaysian Roadside Tree Species Selection Model based on these attributes. This research applied the quantitative and qualitative approaches. The results produced a Malaysian Roadside Tree Species Selection Model.

This section discussed the Malaysian Roadside Tree Species Model. The research findings indicate that roadside trees species selection among Malaysian landscape architects is a more complex process than the ones demonstrated in the literature (Roy, 2014; Miller et al. 2015). The researchers found that education factors including knowledge, experience, skill and expertise influence the selection of roadside tree species. Institutional factors including landscape policies, decision makers and framework and plan could influence the way urban roadside trees species are selected, managed and maintained. Limiting factors including space and location also seem to have influenced the Malaysian landscape architects regarding roadside tree species selection practices. Additionally, the researchers found that four new attributes for tree characteristics which are trending, flowering tree, tree form and themes have strong influence in selecting roadside trees, as well as budget constraints including establishment costs, maintenance costs and removal costs.

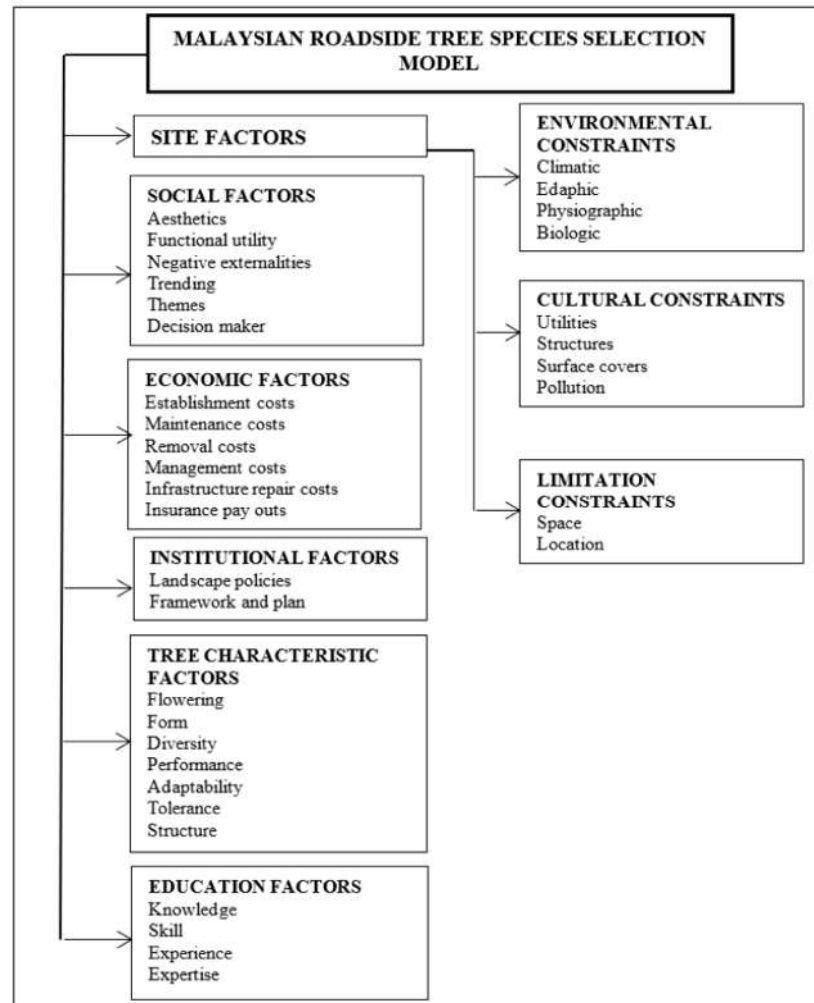

Proposed Malaysian Roadside Tree Species Selection Model

Acknowledgement

This research was funded by the Geran Insentif Penyelidikan (GIP) (600-IRMI / MyRA 5/3/GIP (025/2017) from the Research Management Centre, Universiti Teknologi MARA, Shah Alam, Selangor, Malaysia

References

- Ahmad Nazarudin, M. R. (2016). Xanthostemon Chrysanthus (F. Muell.) Benth.: A new flowering tree for urban landscapes. *International Journal of Agriculture, Forestry and Plantation*, 3, 50-54.
- Ahmad Nazarudin, M. R., Tsan, F. Y., Normaniza, O. & Adzmi, Y. (2014). Growth performance and flowering occurrence of Xanthostemon chrysanthus in two selected urban sites in Kuala Lumpur, Malaysia. *Journal of Tropical Forest Science*, 26(3), 428-434.
- Battipaglia, G., Marzaioli, F., Lubritto, C., Allieri, S., Strumia, S., Cherubini, P., & Cotrufo, M. F. (2010). Traffic pollution affects tree-ring width and isotopic composition of Pinus pinea. *Science of the total Environment*, 408(3), 586-593.
- Hasan, R., Othman, N., & Ismail, F. (2016). Roadside Tree Management in Selected Local Authorities for Public Safety. *Procedia-Social and Behavioral Sciences*, 234, 218-227
- IResponz system, (2017). Retrieved from <http://www.mpsj.gov.my/iresponz/sso/index.cfm?option=help>

1CLICK BUDGET TRAVEL: ONE-STOP PLATFORM FOR BUDGETING TRAVELLER

Mallini A/P Anparasan

Faculty of Hospitality, Tourism & Wellness, Universiti Malaysia Kelantan, Kelantan, Malaysia
mallini.h18a0204@siswa.umk.edu.my

Dhivyaa A/P Selvalumaran, Khirrun An Nisa Bahaudin, Elly Maya Masnida Othman, Chua Hui Qi, Leong Wen Qin & Roslizawati Che Aziz

Faculty of Hospitality, Tourism & Wellness, Universiti Malaysia Kelantan, Kelantan, Malaysia
dhivyaa.h18a0097@siswa.umk.edu.my, nisa.h18a0170@siswa.umk.edu.my, elly.h18a0104@siswa.umk.edu.my,
chui.h18a0088@siswa.umk.edu.my, lwqin.h18a0187@siswa.umk.edu.my, roslizawati@umk.edu.my

Highlights: 1Click Budget Travel is a one-stop platform that provides information focused on domestic tourism which includes local cuisine restaurants, transportation, tourist attractions, cultural activities, and events information. It is developed specifically for those who are looking for budget services while travelling. Since, there is a lack of a platform that provides one-stop centre information, and travellers need to browse many websites for assembling the necessary information, thus 1Click Budget Travel apps exist to share and disseminate all information to the travellers.

Key words: *Budget Travel, one-stop centre, backpacker traveller, budgeting traveling, tourist information*

Introduction

Domestic tourism is indicated as local travel inside its own country with the purposes of visiting blood relations and friends or for the purpose of traveling for relaxation (Ndlovu, Nyakunu & Heath, 2010). The fact that Malaysia is a country that has high potential in advertising local attractions such as local foods and events could attract more budget travellers. Domestic tourism was able to sustain economic growth in the country by supporting local attractions when able to attract international or budget travellers to travel in Malaysia. Undeniably, those coming from different ages of travellers in a range of 20-39 prefer to use online travel applications to gather information whenever they are doing research for their trip or vacation (Jamaludin & Mariapan, 2018).

The implication of domestic tourism in this budget traveling application gives many benefits toward budget travellers. This budget traveling application does not only indicate external features of basic information but with detailed information for budget traveller purposes so that they could access the information precisely and efficiently. The fact that this budget traveling application is a user-friendly application whereby budget travellers able to quickly accomplish the task. Realizing the important of this market segmentation, thus the 1Click Budget Travel application was developed to assist users to utilize this application before travelling without worrying about spending exceed expenditure yet able to enjoy the trip. Moreover, the idea of this budget travel application also is to enhance the flaws that existed in online travel applications and innovate with the general needs of traveller. Hence, there is an opportunity in 1Click Budget Travel application specifically in domestic tourism where there are only several applications available in the market. It is easier for budget travellers to use the 1Click Budget Travel application because it has a variety of features that they could use in a planning trip only by one platform without installing several applications. Besides that, budget travellers are more familiar with using only one platform to search for what they want.

Background of the application

1Click Budget Travel is a budget traveling application that provides one-stop centre information platform emphasizing on domestic tourism in Malaysia. This budget traveling application gives exposure to budget travellers in searching for their perfect vacation. Hence, it is developed for specific target markets such as budget tourists, backpackers, and those looking for the cheapest travel option. 1Click Budget Travel able to help local and international travellers in obtaining relevant domestic tourism information such as local foods, culture activities, time and destination of the bus travel, tourist attractions, and events. It is also an application that makes information such as local foods, tourist attractions, bus schedule culture activities and events accessible to the tourists who are travelling around Malaysia. This application able to facilitate customers because tourists no longer need to search for Google Maps or check the bus website. Furthermore, with the usage of this application tourists may also ensure that they have all the necessary information, including bus stops, routes, and a detailed map of nearby bus stops. Thus, with the development of the application, we can help local and international travellers in obtaining all relevant domestic tourism information in Malaysia. It may also help budget tourists, backpackers, and those seeking the cheapest travel options.

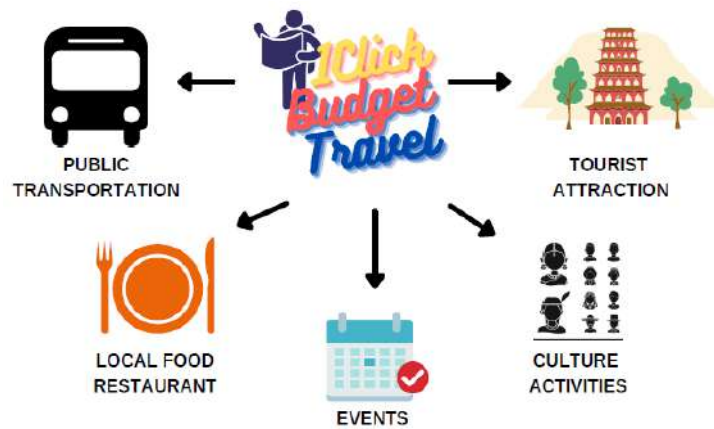

Picture 1: The contents available in 1click budget travel apps

Budget tourists also could use this application for their pre-planning options, provide travel information to travel from one place to another, facilitate or assist tourists, and provide reviews and recommendations. Furthermore, this traveling application aimed to assist and provide related information about budget travel in Malaysia to travellers and to provide them with a variety of options to keep looking for their cheapest travel according to what they desire. The fact that this traveling application could save plenty of travellers in terms of time management, pocket money, and by doing the right thing on deciding decisions. In a way, this budget traveling application gives a huge advantage towards budget travellers that desire on planning their trips or vacation.

Based on previous studies, there is a lack of a platform that provides one-stop centre information about budgeting travel. According to Greg Rodgers (2019), many tourists have been cheated and get overcharged by the taxi drivers and restaurant owners because they are not from the local area and do not know about the road and market prices of the place they travel to. Thus, having a platform that provides one-stop centre information can help travellers from becoming a victim to any crime or scammers while travelling.

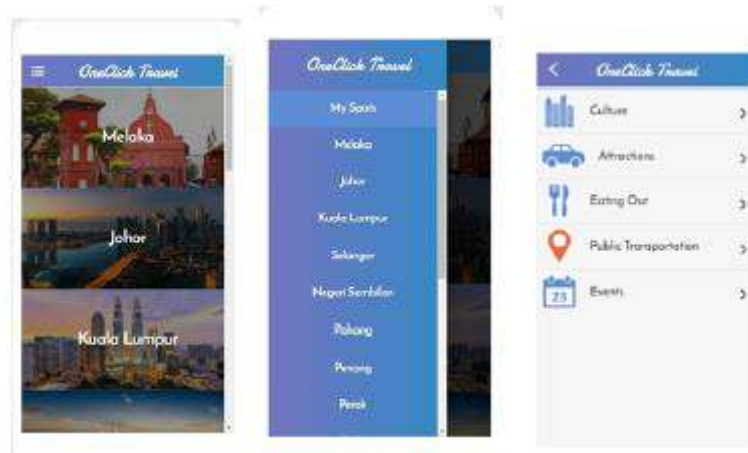

Picture 2: The Prototype of 1click budget travel apps

The application's benefit is that tourists would be able to visit more destinations at a cheaper cost. The 1Click Budget Travel app also includes information on local restaurants and menus, allowing tourists to pick and choose local eateries that are within their budget, allowing them to enjoy diverse places without worrying about going over their budget. Tourists can also obtain easy-to-understand guides about local cultures and customs, which can save them time and allow them to learn about local festivals and activities in the state they are visiting.

The commercial value of 1Click Budget Travel application that help budget travellers to get around and know all of the information provided. In addition, the commercialization value can be transformed as a one-center information platform and this prototype has the potential to be real application in future. 1Click Budget Travel application is recognized and awarded with silver medal and best poster in Beginner Innovation, Exhibition, and Entrepreneurship (BIE) Bootcamp organized by UMK, 2021.

Travel is among the fastest growing industries today, growing faster than the global economy. Within it, the online travel app market is rapidly reaching the incredible size of one Trillion USD, chipping away at the offline and travel agent market shares along the way. High smartphone penetration rate introduced a new era in online travel, in which apps are gradually taking the lead in online booking. For online travel services, this new era introduces number of opportunities, and quite a few serious challenges. The advantage of the One Click application is that tourists can explore more places at a lower cost. The application provides all the information about the famous attractions and restaurants in each state of Malaysia. With just one click on the app, visitors can enjoy more attractions and restaurants. In addition, the app introduces the culture and events of each state, which can save a lot of time for them without searching the information on Google.

The most significant increase in online travel belongs to the Online Travel Agent (OTA) category. In this One Click Travel app we have provided travel agents with more travel facilities information to the tourists. OTA is leading the way in mobile apps, with almost half of all OTA bookings done via mobile devices today. Travel apps, however, are not only used for making reservations. 80% of travellers search for trips using their apps, even when the actual booking is made elsewhere. In addition, mobile apps provide a variety of other services – check-in, price drop alerts, boarding passes, booking vouchers, reservation updates, and many more.

References

- Jamaludin, M., Aziz, A., & Mariapan, M. (2018). Millennial travelers decision making influenced through user-generated contents and psychological attributes on destination loyalty to a tropical island. *Journal of Tourism, Hospitality and Environment Management*, 3(8), 44–55. <http://www.myjurnal.my/public/article-view.php?id=12730>
- Ndlovu, J., Nyakunu, E., & Heath, E. T. (2010). Strategies for developing domestic tourism: A Survey of key stakeholders in Namibia. *International Journal of Management Cases*, 82- 91.
- Rodgers, G. (2019, 13 September). 10 Scams to Avoid in Kuala Lumpur. Retrieved from Trip Savvy: <https://www.tripsavvy.com/scams-to-avoid-in-kuala-lumpur-4156477>

TAMI MULTIPURPOSE HAND SANITIZER

Velan Kunjuran

Faculty of Hospitality, Tourism and Wellness, Universiti Malaysia Kelantan
velan.k@umk.edu.my

Fatimah Zahra Dahalan, Mohd Saiful Jamil, Nur Ain Syafiqah Asha'ari, Wan Muhamad Aqramin Wan Othman, Damayanti Tindo Purwanto, Fatin Nur Hazwani Haron, Nurin Hazirah Razdi, Nurshafikah AB Majid, Nurul Nadia Najmi Azman, & Nursyahira Badarudin

Faculty of Hospitality, Tourism and Wellness, Universiti Malaysia Kelantan
Zahra.h18a0117@siswa.umk.edu.my, Saiful.h18b0232@siswa.umk.edu.my, syafiqah.h18b0347@siswa.umk.edu.my, aqramin.h18a0789@siswa.umk.edu.my, Damayanti.h18b0092@siswa.umk.edu.my, Hazwani.h18a0122@siswa.umk.edu.my, hazirah.h18a0453@siswa.umk.edu.my, shafikah.h18a0457@siswa.umk.edu.my, nadia.h18a0494@siswa.umk.edu.my, syahira.h18a0458@siswa.umk.edu.my

Highlights: The current pandemic of COVID-19 encouraged the society to practise good hygiene to avoid possible infections. Malaysian government has taken several measures to break down the number of cases of COVID-19 namely introducing Movement Control Order (MCO) and Standard Operating Procedures (SOPs) for hygiene. Importantly, hand sanitation is one of the important components in SOPs which believe to destroy the viruses. However, the hand sanitizer currently available in the market pose several questions about its effectiveness and usefulness in eliminating the virus. Such questions are: What are ingredients used to produce the sanitizer? Are there any other benefits of such sanitizers despite eliminating the viruses? Are there any side effects if such sanitizers produced using chemical items? Thus, our team addressed all those above questions by introducing an innovative sanitizer called as 'TAMI Sanitizer'. This innovation was developed based on selected natural ingredients such as Benzalkonium Chloride (antibacterial), Shea Butter, Glycerin, Sugarcane extract, Macadamia Seed Oil (moisturizers), aloe Vera and Lavender. All these ingredients believed to have a lot of benefits such as keep our skin moist, prevent skin irritation, itchy, debilitating, dryness, and even cracking and bleeding despite it does kill the germs. Through the scientific review, we hoped such innovation will benefit the society to utilise it in their daily lives due to its multiple purposes such as eliminate the virus, and protect the skin from sun burn and itchiness. It is also suitable for all ages of society and specially aimed for those preferred natural based products compared to chemicals.

Key words: *Innovative app development, hospitality, customers satisfaction, service providers, tourism*

Introduction and content

Due to the COVID-19 pandemic, all Malaysian citizens are encouraged to stay hygiene and follow the SOPs designed by the Malaysian government. As we all aware that wearing masks, social distancing and usage of hand sanitizer are widely utilised by the citizens to stay resilient to combat the spread of COVID-19. Most importantly, hand sanitizer is widely used and its consumption is unlimited. All service centres, government offices, private and public spaces, schools, hospitals and tourism spaces are provided the hand sanitizer to prevent from infection of COVID-19. Currently in the market, there are too many different types of sanitizers are produced and available for daily usage. However, the high amount of alcohol content in most sanitizers are believed to bring some negative effects and discomfort to the people. Due to this problem, there is a high chances or possibility where the society may reluctant to follow the SOPs specially to sanitize their hands which may increase the risk of spreading especially the COVID-19. Thus, our country's efforts in combating the spread of COVID-19 will be in vain if any of SOPs are avoided. TAMI multipurpose hand sanitizer will be a cure to prevent the spread of COVID-19 in the society. This is an innovative product based on natural ingredients and has multiple health benefits to the society. It is also a motivation to the research team to introduce the multipurpose hand sanitizer which bring multiple health benefits despite its major benefit to kill the germs around the hands. Moreover, this product also helps to prevent skin irritation and provide deep hydration, rapid evaporation, and softening formulation that leaves hands feeling moisturized and smooth while sanitized. It is also may freely use by the society to sanitize their hands without having to worry about sensitive skin conditions. This product helps revolutionize personal hygiene through its gentle creative design and formula on sensitive skin. This product has been developed by the undergraduate students in tourism which clearly shows their capability and entrepreneurial skills. The problem skill while developing this product is also evident. In addition, this innovation is also encouraged the public to follow the SOPs especially the hand sanitation to prevent themselves from the spread of COVID-19. This innovation is great potential to be commercialized by the stakeholders if all the clinical tests and procedures are made.

References

Alessandra, A. J., O'Connor, M. J., & Van Dyke, J. (1994). People Smarts: Bending the Golden Rule to Give Others what They Want. Pfeiffer.

MYh-SMART: AN INNOVATIVE APP FOR HOSPITALITY INDUSTRY

Velan Kunjuran

Faculty of Hospitality, Tourism and Wellness, Universiti Malaysia Kelantan
velan.k@umk.edu.my

Fadhilhanim Aryani Binti Abdullah, Noor Raihani Binti Zainol, Michelle Hoo Yean Nee, Cheah Ing Zhen, Cheong Hui Yin, Chia Choy Cheng Crystalbel, Lee Jia Jin, Lim Chai Hui, Sen Mei Lam, Tan Chin Haw, Tan

Hong Lin & Wee May Yee

University Malaysia Kelantan
velan.k@umk.edu.my

Highlights: Hospitality industry in Malaysia is a major service industry that provides convenient accommodation services to the guest while travelling. To maximize the customer satisfaction, the accommodation providers may consider several methods in their operation especially related to in-house services such as room service, ordering service, and customer service. Thus, by utilizing the mobile technology, an innovative MYh-SMART app has been developed as the best tool to the service providers to offer convenient services to the guests, as a result may boost their company turnover. These MYh-SMART app is different from the existing app services due to the users friendly-content. In addition, the customers may enjoy and explore the in-house services through the apps to maximize their experiences. Long travelling hours and hectic travel schedule will spoil the customers' leisure experiences. Thus, this app perhaps will ease their travel journey with up-to-date information and maximum enjoyment.

Key words: *Innovative app development, hospitality, customers satisfaction, service providers, tourism*

Introduction & Contents

Generally, innovation elements are the important items that can be concerning to long-term companies. They help to promote the new digital innovation and overcome the challenge the faces especially in the tourism and hospitality industry. According to Law (2018), mobile technology can allow hotel managers to connect with their existing and potential customers. To date, innovation apps allow the local communities and businesses to take part in the app creation process to develop creative and innovative designs. The app's development can try to meet new needs and give a superior and comfortable experience to the users. Due to the hectic travelling schedule, the tourists are often faced with numerous hassles while travelling especially, to identify the best service providers in their travel destinations. Due to the hectic travelling schedule, they prefer to minimize their energy and time to enjoy the services provided by the hotels and other accommodation service sectors. Moreover, the pandemic of COVID-19 has limiting them to have less contact with people while traveling and they opted to compile with SOPs. With this in mind, the MYh-Smart App can help the hotels and other service providers to enhance their service experiences to become more successful and creative at par with other service providers. According to Criton (2020), an app can help to enhance customer experience, save time and improve work efficiency.



Figure 1: MYh- SMART App Logo

MYh-Smart Apps is designing by Adobe XD. It has four columns in the apps, which are "Home, Room Service, Menu and Attraction". The room service is split into three parts which are ordering services, clean services, and feedback. Services have provided and several of information of the attraction places through the apps. Customers can appeal to get the room service which is clean services to clean the whole room, bed, and bathroom. They can call for the hotelier to send the cleaner to clean the bed after they had the rest and leave feedback after using the services by using apps. For menu segment, it has breakfast, lunch, and dinner. Customer can browse the menu, order it through apps and wait for the hotelier to send in front of the room. The fourth column is attraction. It will show many attraction places. Customers can search the interesting places in Malaysia through the app and maximize their leisure time.

In addition, some other features in this app included namely, the check-in and check-out the room, control the switch of the light and see television station. Such features may help the customer use a device to control certain facilities in the room without moving too much in the room. This innovative app has been developed by the undergraduate of UMK. This is an evident that the students can identify the problem occur in real life experiences and able to innovate new tool to solve such problems. This is also a platform for them to enhance their entrepreneurial and problem-solving skills. This innovative app may be commercially available soon after it is approved by the authorized body. MYh-Smart Apps will cost differently through android and iOS. This innovative app can be assisting more hoteliers need to understand the function of the app. It can increase the hotel brand and customer loyalty. It helps the hotel to fulfill customer satisfaction to gain profit in a sustainable way.

Acknowledgement

First and foremost, with the praises and gracefully to almighty God that give us such as a great opportunity and time for us to finish and done our beginner innovation, exhibition and entrepreneurship. Besides that, we like to respect and thankful to our mentors for giving us such as a great opportunity and guidance for us to do our product innovation which can help and made the assignment full complete and successful on time. We are extremely grateful and thankful to them for providing such as nice support and guidance. Next, we like to thank to the coordinator that give us the time and manage us to done and complete this assignment smoothly. Finally, we like to thanks to each of our group members that give us such effort and cooperation for us to done and complete this assignment. Without them we will now finish this assignment on time and smoothly. Last but not least, we like to express our thanks to our friends and parents for their support and guidance to spend more time with us.

References

- Law, R., Chan, I. C. C., & Wang, L. (2018). A comprehensive review of mobile technology use in hospitality and tourism. *Journal of Hospitality Marketing & Management*, 27(6), 626–648. doi:10.1080/19368623.2018.1423251.
- Criton. (February 4, 2020). 10 Reasons Why Your Hotel Needs A Mobile App. Retrieved from <https://www.hotelspeak.com/2020/02/10-reasons-why-your-hotel-needs-a-mobile-app/>

FAIR SKIN PRODUCT

Nor Syuhada Zulkefli

Faculty of Hospitality, Tourism and Wellness, University Malaysia Kelantan, Kelantan
syuhada.z@umk.edu.my

Fadhilhanim Aryani Abdullah, Norelisa Bakri, Nurdy'anna Nordin, Siti Munirah A. Kadir, Arisa Arifah Kamaluddin, Nur Humirah Rizwan, Nur Rusfadilah Ruslan

Faculty of Hospitality, Tourism and Wellness, University Malaysia Kelantan, Kelantan
aryani.a@umk.edu.my, elisa.h18a0332@siswa.umk.edu.my, dyanna.h18a0371@siswa.umk.edu.my,
munirah.h18a0578@siswa.umk.edu.my, arisa.h18b0794@siswa.umk.edu.my, humirah.h18a0388@siswa.umk.edu.my,
rufadilah.h18a0405@siswa.umk.edu.my

Highlights: Mint leaves are the aromatic herbs which are used fresh as well as dried in many dishes. This product aims to combine mint leaves and honey in one skincare product as Fair Skin Toner. This toner can be the perfect combination for skin treatment. Mint leaves can refreshes skin and minimizes the appearance of pores; while honey is an excellent humectant and thoroughly moisturizes skin. This product will come out with two bottle variations. This toner is suitable for a daily application. The potentially of this product innovation will help all people, especially teenagers to have a beautiful and health skin.

Key words: *Mint leaves; Honey; Toner; Skin.*

Introduction

Acne is the most common skin problem and affecting to all ages of people during adolescence. This is because facial acne is difficult to camouflage, it can produce lasting physical and emotional scars, which impact self-image, create a barrier to interpersonal relationships, and promote social biases. Therefore, toner as a skincare product or simply toner can solve this problem. Toner are designed to cleanse the skin and shrink the appearance of pores, usually used on the face. Toner is a water-based texture and usually applies after washing the face. Toner is functioning to remove any last traces of dirt, grime, and impurities stuck in your pores. According to a board-certified dermatologist from New York City, Dr. Hadley King, toner can be a great weapon for having healthy skin. Toner is most helpful and necessary for people who want extra cleansing after wearing makeup or other heavy skin products such as sunscreen. Many people used toner because they care about their healthy skin. Although they need to know about their skin type and what ingredient suit their skin well to make it turn out a great result. There are four types of toners, which the first one is skin bracers or fresheners (the mildest), skin tonics (slightly stronger), acid toners (strong), and astringents (the strongest). Besides, nowadays many toners in current market have mixed their ingredient with chemical product to get a quick effect. Therefore, this project trying to innovate for toner product that are suitable for all Asian's skin by introducing Fair Skin Toner.

Content

Fair skin toner is a natural skin care product designed to cleanse the skin, reduce acne, heal scars and minimize the appearance of pores. This natural toner skin care product has contained mint leaves and honey as the main ingredient. There is also contains PHA, AHA, BHA, and 2% of niacinamide. The referencing of choosing the main ingredient is focus on problem-solving which is to inhibits the growth of acne on the face. The product is worth having because we had used the best combination of ingredients which is honey and mint leaves in treating the acne problem. Mint leaves are great for dries acne, brightens facial skin, and removes blackheads while honey is good for moisturizes the skin, treats acne, heals wounds, and exfoliates the skin. Fair skin toner has come out with two bottle variation which is three different set of bottles and a travel kit which easy to bring anywhere. The target mission of developing these toners is to help people build confidence through having healthy skin.

The early idea of the innovations was sparked when we have a light discussion about acne problems. We find out that acne problem is the most common problem facing by Malaysian. According to a study published in the Journal of Primary Healthcare, facial acne affects 67.5 percent of Malaysian teenagers, and the rate of facial acne increases with age. Acne is more common among male teenagers aged 13 to 18, according to the survey, with 71.1 percent of males and 64.6 percent of girls suffering from the condition. The statistic shows that half of the Malaysian teenager is facing this acne problem. Routine skin care is important. The dermatologist and beauticians all agree that people should start their routine skincare at teenage age to have supported a great skin for life. Thus, we have chosen toner due to many people have face wash but not everyone had used toner in their skincare routine. Toner has the best benefit for healthy skin such as acts as double cleansing and removes dead skin. Double cleansing is important to inhibit the growth of acne while removing dead skin is for increases the skin's radiance, clarity, and youthfulness, and that's just the start.

Thus, it also important towards education which are customers or users may be able to understand the skin situation and gain more knowledge and information about the better cosmetics that has suitable ingredients with their skin. In fact, there has a lot type of skins such as normal skin, oily skin, dry skin, combination skin, acne prone skin and sensitive skin which important to education which people may understand their own skin in order to use a suitable product. Other than that, with the use of Fair Skin Product, it important which should be able to perceive people more favourably in terms of personality characteristics which may improve the appearance or image of individuals. Thus, with a good image or the appearance people may develop their confidants and it also important to education. There has a lot of advantages of Fair Skin Product which are the quality of the ingredients, the protection from acne including environmental damage such as pollution, help skin to fights with the effects of aging such as wrinkles and sunspots and else. In terms of quality ingredients, Fair Skin Product use the natural ingredients in order to protect skin from irritation. Furthermore, the ingredients of Fair Skin Product by the natural ingredients which indirectly enhance the appearance since the existence of mankind. For example, mint leaves contain the essential oil which it is also known as the major source of plants and have been used in skin care. In terms of commercial and add-value, this product focus on the ingredients, convenient and the price. For ingredients, this toner uses the natural ingredients, which are honey and mint leaves including contains PHA, AHA, BHA, and 2% of niacinamide. In addition, this product does not give any negative effects on the skin such as irritation, in fact it repairs the skin to become healthier. The Fair Skin Product also came out with two bottle variations with three different set of bottles and a travel kit which convenient and comfortable to bring anywhere. For price, the product was set with affordable and reasonable price around RM 15 depending on their size and quantity. We are developing this toner in order to help people, who want to build their confident by having healthy skin.

Acknowledgement

We are grateful to the Beginner Innovation Exhibition (BIE event 2.0) for this opportunity given.

References

- Adhalina, N. (2011). The Different Language Style and Language Function Between Students and Teachers in Updating Their Status In Facebook Webpage (A Case Study of the Topic National Final Examination 2011) (Doctoral dissertation, University of Diponegoro).
- Desam, N. R., & Al-Rajab, A. J. (2021). The Importance of Natural Products in Cosmetics. In *Bioactive Natural Products for Pharmaceutical Applications* (pp. 643-685). Springer, Cham.
- Jenice. (2021, March 1). 21 Best Toners Malaysia 2021: For Dry, Oily & Combination Skin (How to Choose). Retrieved from Bestbuyget: <https://bestbuyget.com/toner-malaysia/>
- Usigan, Y., & Ortiz, J. (2021, January 21). Face toner can boost your complexion — here's 10 options for every skin type. Retrieved from Today: <https://www.today.com/shop/6-reasons-why-you-should-use-facial-toner-t73941>

HERB2BE HERBS TEABAG: SOLUTION TO DYSMENORRHOEA (MENSTRUAL PAIN)

Nur Athirah Sumardi

University Malaysia Kelantan, Bachok, Malaysia
athirah.s@umk.edu.my

Fadhilahanim Aryani Abdullah, Nur Hafizah Muhammad, Ghazali Ahmad, Nur Aliah Mansor

Universiti Malaysia Kelantan, Bachok, Malaysia
aryani.a@umk.edu.my, hafizahm@umk.edu.my, ghazali@umk.edu.my, aliam.m@umk.edu.my

Highlights: Herb2be herbs teabag is a combination of herbs served in one teabag, specifically to reduce the pain of dysmenorrhoea. Dysmenorrhoea is a term used to describe severe menstrual cramps or in concise, the period pain (menstrual pain). The purposes of innovating this herbal teabag are to help consumers to relieve menstrual pain, smoothen the menstrual cycle, as well as improve their quality of life. This product is upgraded by using ingredients that are different from similar products such as mint leaves. This product is safe to be consumed as it only contains natural ingredients. Besides, hygiene has been the top priority during the manufacturing process of each teabag.

Key words: *dysmenorrhea, teabag, menstrual cramps, natural ingredients, teenage girls, women*

Introduction

Dysmenorrhoea has been one of the main burdens among teenage girls and women. Some of them suffer from primary dysmenorrhea, and some may suffer from severe dysmenorrhoea. Dysmenorrhoea brings a lot of worries and inconveniences to teenage girls and women. It affects the quality of day-to-day life, causing the ladies to skip works and schools as well as put them in difficulties to join sports activities. There are many supplements that help in reducing dysmenorrhoea; however, most supplements and treatment are expensive and not affordable for some average and low-income women. Therefore, this group decides to innovate herbs teabag called 'Herb2be herbs teabag' to reduce dysmenorrhoea. The combination of herbs such as ginger, lemongrass, mint leaves, goji berries, and red dates can effectively reduce the pain. The objective of producing herbal teabag is to relieve the pain of dysmenorrhoea, smoothen the menstrual cycle among girls and women and improve their quality of life.

Content

Dysmenorrhoea is a pain experienced in the lower abdomen or pelvis during menstruation. Dysmenorrhoea causes women to not be able to concentrate on work, leading to poor performance while teenage girls cannot concentrate on study. A survey conducted by Lokman (2017) showed that 80% of Malaysian women who have suffered from menstrual pain consensually agreed, it has affected their ability to work. This is also supported by Lee et al. (2006) whereby the results showed menstrual pain among teenage girls in Malaysia has affecting their class concentration. Hence, Herb2be herbs teabag is an innovation to treat menstrual pain at an affordable price and safe to be consumed. Besides, this teabag will serve the teenage girls and women as the solution of dysmenorrhoea by helping them to reduce and relieve menstrual pain, relax the muscles of the abdomen, reduce the body calories, improve the quality of their sleep as well as maintain their daily routine activities.

Herb2be herbs teabag represents the identity of Malaysia as part of Asia, with the usage of Asia-related ingredients, combining the sun-dried natural herb ingredients such as ginger, lemongrass, mint leaves, goji berries, and red dates in a round shape teabag. According to Ozgoli, Goli, and Moattar (2009), consuming 250 mg of ginger powder four times a day for three consecutive days, will help to relieve menstrual pain. In fact, teabag ingredients like ginger, lemongrass, and mint leaves effectively treated menstrual pain (Panwar, 2016). Other than that, Goji berries and red dates may also help to improve women's health. These natural ingredients will be sun-dried in order to enable the consumers to store the teabag in cool and dry places within one to three months. Consumers can enjoy the tea with three simple steps. Firstly, put the teabag in a cup or glass, then, pour some hot or warm water into the glass. Finally, remove the teabag from the water after soaking it for about three minutes and it is ready to be served.

Furthermore, Herb2be teabags will be individually packed, allowing consumers to bring it anywhere, along in the handbag. This product is environmentally friendly as the packaging is created using recycled paper and the sachet is biodegradable. Other than that, this product is affordable and cheap as compared to any other similar products from other countries due to its low production costs. This is due to the fact that all the herbs required, are easily obtained ingredients which enable the product to be produced in low cost.

Nowadays, social media has strongly powered up to significantly help to promote a product to reach to its business market, conveniently enable the possibility of Herb2be herbs teabag to penetrate the domestic market. This product will be promoted by the influencers who are active with good image on social media such as Instagram, Facebook, Twitter, and Tiktok. This teabag can be purchased from pharmacies and drug stores as it will be registered with Ministry of Health (MOH), to be evaluated and tested for its efficacy and safety. Potential consumers will be persuaded and encouraged to try this product as the registration certification from MOH will guarantee the safety value of the teabag.

Rather than consuming a marketed drug to reduce the pain of menstruation, there are consumers who are looking into alternatives which may include this teabag. In addition, when everything revolves with digitalization, this product is also aimed to be sold through e-commerce platforms such as Shopee and Lazada. Though this product may be insignificant for some people especially the males, but they should prepare this in case they have sisters, wife, mothers and female friends. Dysmenorrhoea is no longer something that should be kept inside, it is something that should be cared about.

Acknowledgement

We would like to express our sincere gratitude to our students, for wonderfully inspire us with this great idea and the endless cooperation throughout completing this project. We appreciate and are truly grateful to have the opportunity to be part of this project.

References

- Lee, L. K., Chen, P. C., Lee, K. K., & Kaur, J. (2006). Menstruation among adolescent girls in Malaysia: a cross-sectional school survey. *Singapore Medicine Journal*, 47(10), 869-874.
- Lokman, T. (2017). Period pain can affect work performance, some countries allow time off work to cope. Retrieved from <https://www.nst.com.my/news/nation/2017/10/290253/period-pain-can-affect-work-performance-some-countries-allow-time-work>
- Ozgoli, G., Goli, M., & Moattar, F. (2009). Comparison of effects of ginger, mefenamic acid, and ibuprofen on pain in women with primary dysmenorrhea. *Journal of Alternative and Complementary Medicine*, 15(2), 129-132. doi:10.1089/acm.2008.0311
- Panwar, T. (2016). Menstrual hygiene day: 8 natural ways to relieve period pain, stress. Retrieved 17 June 2021, from <https://www.hindustantimes.com/health-and-fitness/menstrual-hygiene-day-8-natural-ways-to-relieve-period-pain-stress/story-zMGJhYWh6jXdGh0t99hUL.html>

PROTOTYPE FORMATION FOR DEVELOPING HERITAGE TRAIL VIA QR CODE APPLICATION AT SUNGAI BUDOR VILLAGE, KELANTAN

Ramly Hasan

Faculty of Architecture and Ekistics, University Malaysia Kelantan,
Bachok Campus, 16300, Bachok, Kelantan, Malaysia
ramly.h@umk.edu.my

Shardy Abdullah, Wan Saiful Nizam Wan Mohamad, Noorliyana Ramlee, Mohammad Rusdi Mohd Nasir, Yeo Lee Bak, Wan Azlina Wan Ismail, Nurul Izzati Othmani, Syahidah Amni Mohamed, Nurfadilah Saadul Kurzi, Nor Hamizah Abdul Hamid

Faculty of Architecture and Ekistics, University Malaysia Kelantan,
Bachok Campus, 16300, Bachok, Kelantan
shardy.a@umk.edu.my, saifulnizam@umk.edu.my, liyana.r@umk.edu.my, rusdi.mn@umk.edu.my,
yeoleebak@umk.edu.my, azlina@umk.edu.my, izzati.o@umk.edu.my, amni.m@umk.edu.my,
nurfadilah.sk@umk.edu.my, norhamizah@umk.edu.my

Highlights: A set of prototype heritage trail in Kampung Budor will be frame (a information board) and will be made as guided to the local community and the tourists while in Kampung Budor. This project produce new knowledge (I) development a set of prototype for heritage trail at Kampung Sungai Budor, Kelantan and (ii) educate and knowledge transfer between experts (academician and practices) and local people related to propose heritage trail. These projects improve quality of life of local people in term of job opportunities and socio culture. The product of prototype for heritage trail attracts the tourist and make easy to explore the cultural values that have in this site. Community can promote their product to tourist and develop their products internationally.

Key words: tree selection model, tree characteristics, landscape architects, tree growth

Introduction

Successful heritage trails provide information about, and commemorate, past historical events, places and peoples. The trails provide considerable public enjoyment and recreation, both for residents and tourists. In addition, serve a variety of important social, economic and political purposes. Furthermore, heritage trail is one of image improvement and boosting a sense of place. There are many examples of village that have used heritage trails as a way of improving their public images and promote the local product. Another purpose of heritage trails is the economic development at kampung Sungai Budor, Kota Bharu Kelantan. Trails can also serve in place as promotional efforts.

However, there is some issues was found in this project such as lack of infrastructure and facilities in site, lack of proper heritage trail to promote the local products and lack of promotion about the existence cultural heritage. The main goal of this project is to help people visit a city following a trail adapted to their preferences, interests and conditions, and receive information about the possible attractions and points of interest of the place. The aim can be achieved through the following objectives (1) to examine the cultural heritage in Kampung Budor as tourist attraction ;(2) to design a proper accessibility for the community and (3) to develop a prototype for heritage trail. Mix method is use use such as interview, self-observation and survey using questionnaires.

The data was analyse using Atlas Ti. version 7 and SPSS version 21 software. The results produce a prototype for heritage trail in Kampung Sungai Budor. The local people and visitor can used their own smartphones to use the app to explore the trail. The prototypes solves the problem related to the accessibility, provide new facilities to explore the heritage trail and easy to promote the local products for the tourist. The novelty of this project is produce new knowledge for the local people and tourist.

Acknowledgement

This research was funded by the Geran Penyelidikan UMK Prototaip (UMK PRO 2020)(code-R/PRO/A1200/01858A/001/2020/00868) from the Research Management Centre, Universiti Malaysia Kelantan, Malaysia.

References

- Al-hagla, K. S. (2010). Sustainable urban development in historical areas using the tourist trail approach: A case study of the Cultural Heritage and Urban Development (CHUD) project in Saida, Lebanon. *Cities*, 27(4), 234-248.
- McKercher, B., & Du Cros, H. (2002). *Cultural tourism: The partnership between tourism and cultural heritage management*. Routledge.
- Holloway-Attaway, L., & Vipsjö, L. (2020). Using Augmented Reality, Gaming Technologies, and Transmedial Storytelling to Develop and Co-design Local Cultural Heritage Experiences. In *Visual Computing for Cultural Heritage* (pp. 177-204). Springer, Cham.
- Spencer-Wood, S. M. (2020). Creating a More Inclusive Boston Freedom Trail and Black Heritage Trail: An Intersectional Approach to Empowering Social Justice And Equality. *International Journal of Historical Archaeology*, 1-65.

3 LAYERS KAMPUNG SCENTED CANDLE

Ruzanifah binti Kosnin

Universiti Malaysia Kelantan, Kota Bharu, Malaysia
ruzanifah@umk.edu.my

Fadhilahanim Aryani binti Abdullah, Aina Mawaddah Binti Hamdanni, Diveiga A/P Poobalan, Fatin Nurliyana Binti Mohd Rosley, Izzati Binti Razlee, Khalida Najihah Binti Johan, Norshazani Binti M Hanafi, Nur Hanis Binti Mohd Nasir, Nurin Rasyidah Binti Rosli, Rohaya Binti Jonaidey, Siti Syazwina Binti Abdul Hamid

Universiti Malaysia Kelantan, Kota Bharu, Malaysia

aryani.a@umk.edu.my; mawaddah.h19b0026@siswa.umk.edu.my; diveiga.h18a0100@siswa.umk.edu.my; liyana.h19b0127@siswa.umk.edu.my; izzati.h19b0163@siswa.umk.edu.my; khalida.h19b0179@siswa.umk.edu.my; shazani.h19b0163@siswa.umk.edu.my; hanis.h19b0537@siswa.umk.edu.my; rasyidah.h19b0624@siswa.umk.edu.my; rohaya.h19b0752@siswa.umk.edu.my; syazwina.h18a0607@siswa.umk.edu.my;

Highlights: The objective of 3 Layers Kampung Scented Candle is to help provide comfort to those who are distressed by insomnia. Insomnia which are caused by stress, anxiety, and depression may lead to greater health damages if not properly treated. Research has shown that certain scents could provide therapeutic solution to this problem. 3 Layers Kampung Scented Candle is designed with the aroma of "Kampung", comes in 3 types which are Chanteq, Srikandi and Qaseh Candle made from flowers and herbs that easily available in Malaysia. These candles are suitable for any individuals with sleeping difficulties or as calming effects.

Key words: *Kampung scents candle, herbs, insomnia, therapeutic, stress reliever, relaxation.*

Introduction

3 Layers Kampung Scented Candle is an innovative candle that focusing to solve the problem of individuals with insomnia due to stress, anxiety and depression by giving it calming effect from the candle scents. Aromatherapy scented candle able to give more relaxing effect to produce more productive and positive mindset. This product mission is to help individuals by effectively provide an affordable price of RM15 each will give a high satisfaction and an easy solution to insomnia problem. There are three types of 3 Layers Kampung Scented Candle which are Chanteq, Srikandi and Qaseh candle. The aim to help consumer to get their dreamy nights with the scent that concentrate on enhancing relaxing and calming effect.

Content

Our candles are specially designed with scents that has not been available in the market. Using common materials such as flowers and herbs found in Malay world, this novel scented candles have three layers of different scents from natural and organic sources that come from the village and that is why this scented candle is named 3 Layer Kampung Scented Candle. Our candles are divided by three types which are Chanteq, Srikandi and Qaseh candle. Each has three-layer scented candle with a new unique kampung scent. Chanteq candle is made from Malay flowers scents which are rose (mawar), jasmine (melati) and ylang-ylang (kenanga); Srikandi candle is made from herbs which are nutmeg (buah pala), agarwood (gaharu) and cinnamon (kayu manis); and finally Qaseh candle is made from fresh Malay herbs which are lime (limau nipis), citronella (serai) and cinnamon (kayu manis). All the scents in out candles are common and easily available flowers and herbs in Malaysia.

Scented candles are often used in many cultures with various health benefits. Scientifically, there is evidence to show that smelling scented candles can stimulate limbic symptoms in the human body, the brain as a place of memory and emotions (Chalkia, 2018). Among the hormones produced are the hormones serotonin and dopamine which regulate a person's mood. Thus, a person's condition is influenced by the ashes of aromas, memories, and emotions. It is proven that scented candles are able to play an essential role in the physical effects of mood, stress, working capacity, and overall mental health.

This innovation is important to education because, wellness is an ever-growing industry especially now when health issues arise. This 3 Layers Kampung Scented Candles open up opportunity in wellness industry to capture Malay natural products to be expand further locally and internationally. This eventually will bring benefit to education sector and local community.

Some of the many advantages of this innovative products are health benefits and potential markets. Each of these types of candles produce different smells depending on individuals preferences. The smell produced by these candles can give calming and comforting effect to a person having trouble sleeping (insomnia), prolonged stress, and spend a lot of time with the phone then addicted to using it. This kampung scented candles not only give benefits such as relieve stress, strengthen the immune system, help for lower blood pressure, and relieve anxiety, it will also help bring back memories of a village environment especially in this challenging time of not able to travel during the COVID-19 pandemic. Additionally, these candles provide natural remedies which will not harm or put any negative side effects.

Commercial value can be stated as a fair market value of a product or service if it were offered for sale. The combination of three kampung scents in the candles are new in the market. These candles are suitable and useful for any working adults, students or any individuals with sleeping problems, distress, or emotional problems as well as those who want to experience a calming environment. We offer a reasonable price of RM15 each which is affordable to all income groups for our products. For establish our product we create video and poster for attract customers as an advertisement plan. As a last, we have plan to promote our product in social media which could reach customer fast.

Acknowledgement

We would like to express our sincere and heartfelt appreciation for the Faculty of Hospitality, Tourism and Wellness as well as Universiti Malaysia Kelantan for giving us an opportunity to embark in this innovation carnival. We are also grateful to all who has helped us along the way for the creation of this 3 layers kampung scent candle.

References

- Cornish, K. (2020, May 16). The Benefits of Scented Candles According to a Psychotherapist. Travel and Leisure. <https://www.travelandleisure.com/style/shopping/benefits-of-candles>
- Chalkia, C. (2018, August 27). Scented candles to reduce anxiety. Counselling Directory. <https://www.counselling-directory.org.uk/memberarticles/scented-candles-to-reduce-anxiety>

SCIENTIFIC ECO-AGRO TOURISM MODEL IN MERAPOH, PAHANG

Muhammad Aminuddin Baqi bin Hasrizal Fuad

Faculty of Earth Science, Universiti Malaysia Kelantan, UMK Jeli Campus, 17600 Jeli, Kelantan, Malaysia.
Conservation & Research Program, Malayan Rainforest Station, 27210 Kuala Lipis, Pahang, Malaysia
aminuddin.g19d010f@siswa.umk.edu.my

Mohammad Hafiz Bin Mohd Yazid^{1,2}, Mohamad Nur Arifuddin Bin Mad Yusof^{1,2}, Mohamadlzereen Bin Amat Mukri^{1,2}, Balakrishnan Parasuraman³, Suganthi Appalasamy^{1,4}, Boon Jia Geng¹ & Jayaraj Vijaya Kumaran^{1,2,5 & 6}

¹Faculty of Earth Science, Universiti Malaysia Kelantan, UMK Jeli Campus, 17600 Jeli, Kelantan, Malaysia.

²Conservation & Research Program, Malayan Rainforest Station, 27210 Kuala Lipis, Pahang, Malaysia

³Faculty of Entrepreneurship and Business, Universiti Malaysia Kelantan City Campus, Pengkalan Chepa, 16100 Kota Bharu, Kelantan.

⁴Institute of Food Security and Sustainable Agriculture, Universiti Malaysia Kelantan, UMK Jeli Campus, 17600 Jeli, Kelantan, Malaysia.

⁵Global Entrepreneurship Research and Innovation Centre, Universiti Malaysia Kelantan Pengkalan Chepa, 16100 Kota Bharu, Kelantan.

⁶Academy of Sciences Malaysia, Level 20, West Wing, Menara MATRADE, Jalan Sultan Haji Ahmad Shah 50480 Kuala Lumpur, Malaysia.

muhammadhafizyazid@gmail.com, mohdnurarifuddin@gmail.com, izereenmukri@gmail.com
balakrishnan@umk.edu.my, suganthi.a@umk.edu.my, jia.geng@umk.edu.my & jayaraj@umk.edu.my

Highlights: The Scientific Eco-Agrotourism model combines ecotourism, agro-tourism and local community involvement with added scientific input and output in Merapoh, Pahang. For the agro-tourism aspect, tourists will experience the village lifestyle with the local communities and be involved in their agricultural work. Nature guides and tourists will greatly benefit from the scientific input added into ecotourism from new knowledge and being involved in field research. Lastly, this tourism model aims to promote scientific thinking among the public and support nature conservation efforts by making the local community the stewards of the land.

Key words: *Ecotourism; Agro-tourism; Local community involvement; Scientific input*

Introduction

The Scientific Eco-Agrotourism model combines ecotourism, agro-tourism and local community involvement with added scientific input and output in Merapoh, Pahang. For the agro-tourism aspect, tourists will experience the village lifestyle with the local communities and be involved in their agricultural work. Nature guides and tourists will greatly benefit from the scientific input added into ecotourism from new knowledge and being involved in field research. Lastly, this tourism model aims to promote scientific thinking among the public and support nature conservation efforts by making the local community the stewards of the land.

Content

1. Description of your innovation / product development / design / process.

The model we are developing integrates ecotourism and agro-tourism with added scientific input and output, promoting scientific thinking and conservation efforts to the general public. Our location is in Merapoh, Pahang. Surrounded by a large number of limestone hills of the Gua Musang Formation, the Merapoh cave system consists of 85 explored caves believed to be 130 million years old, along with many more unexplored caves waiting to be discovered. The abundance of limestone hills in Merapoh and the vicinity of Taman Negara Pahang Sungai Relau and several forest reserves, including Persit Forest Reserve, Sungai Yu Forest Reserve and Tanum Forest Reserve (Miard et al. 2020). A mixed fruit orchard located near Bukit Bekong limestone massif alone harboured 28 small mammal species; this small area showcase the immense potential of the biodiversity richness in Merapoh, particularly karst flora and fauna (Aminuddin Baqi et al. 2020).

Tourists will indirectly be involved in academic data publication by funding and participating in local research and conservation efforts. Tourists from different backgrounds will experience village lifestyle with the local communities and be involved in their daily routines such as rubber tapping, fruit harvesting, aquaculture and Orang Asli living skills. The second part of this model includes tourists tagging along with scientists and approved nature guides with the research projects like bird density count, herping and nocturnal surveys. These approved nature guides will receive scientific input from the scientists and learn new skills to boost conservation efforts. With greater involvement from scientists in providing specialized knowledge to the tourists, the tourists would gain vast insight and experience, developing love towards nature and indirectly enhance nature conservation efforts.

2. What is the context or background of the innovation / product development / design / process?

We developed our tourism model to involve and benefit more local people holistically in Merapoh. In many instances, not many locals directly profit from the flow of tourists coming into their place, and for some-places, outsiders are the ones that benefit the most (i.e. large scale resorts). By incorporating agro-tourism through the local community, locals can gain extra side income while tilling their main agriculture work fields. On the ecotourism side, our experience as field biologists in Merapoh with nature guides were quite lacklustre, especially with the younger nature guides who know little of the nature that they are supposed to bring tourists with. By teaching extra knowledge from a scientific standpoint, we hope not only to enhance the ecotourism experience for tourists but also make the local community the stewards to preserve the uniqueness and beauty of the tourism area stand out even more to attract future tourists.

3. Why are they important to education?

Education is always an integral part of nature conservation. The main purpose of this model is to educate, for the community to take care of their environment; for the nature guides and young people to be citizen scientist; for tourists to gain a richer, more knowledgeable nature experience. Our tourism model takes inspiration from school field trips and knowledge transfer programme.

4. Advantages of innovation / product development / design / process towards education and community

The advantages of this model includes providing extra income for the local community, giving more control to the locals involving in the tourism sector, providing scientific input to the public in a more digestible manner and conserving nature for future generations.

5. Commercial value

- Our tourism model is unique and holistic
- Local community involvement
- Can be replicated in any ecotourism area

Acknowledgement

The authors would like to express gratitude to the researchers and volunteers from Malayan Rainforest Station (MRS) for the scientific research conducted in Merapoh, Pahang. We would also like give a thousand thanks to Merapoh Adventure and other nature guides for giving us inspiration to develop this tourism model.

References

- Aminuddin Baqi MHF, Mohamad Iqbal NH, Nur Nabilah AR, Nur Ain Aiman AR, Suganthi A, Fong PH & Jayaraj VK (2020). The diversity of small mammals in a mixed fruit orchard at Bukit Bekong limestone massif, Merapoh, Pahang, Malaysia. IOP Conference Series: Earth Environment Science, 596: 012073. <https://doi.org/10.1088/1755-1315/596/1/012073>
- Miard, P, Arifuddin, M, Mukri, I, Sapno, S, Yazid, H, Ruppert, N, and Jayaraj, VK (2020). Sighting of *Petaurista petaurista* (Pallas, 1766) (Mammalia: Rodentia: Sciuridae) on limestone hills in Merapoh, Malaysia. Journal of Threatened Taxa 12(3): 15355-15358. <https://doi.org/10.11609/jott.5419.12.3.15355-15358>

EMOSIHAT: AN EMOTION BOARD GAME FOR CHILDREN

Siti Fatimah Ab Ghaffar

Faculty of Hospitality, Tourism and Wellness, Universiti Malaysia Kelantan, Malaysia
fatimah.g@umk.edu.my

Normaizatul Akma Saidi

Faculty of Hospitality, Tourism and Wellness, Universiti Malaysia Kelantan, Malaysia
akma.s@umk.edu.my

Highlights: An emotion board game, known as EMOSIHAT, invented to educate primary school children about emotion through play. Children will learn about knowledge on emotions, such as types of emotion and emotion triggers. Children will be able to identify types of emotion correctly through emotion facial expression and other emotion cues, for instances, body language and emotion words. A part from that, children will be able to develop basic emotion regulation and empathy skills.

Key words: *emotion, board game, primary school, children.*

Introduction

Mental health problem become one of the main public health concerns, especially children (Shahril, et. al., 2021). Depression and anxiety are most common mental health problems in Malaysia. Children with mental health problem are at higher risk of developing mental health disorder during adulthood. Thus, early intervention is vital to reduce mental health problem in children.

Product Description

This board game was inspired by available board game available in Malaysia, for example, *Saidina*. This board game consisted of a board, a dice, three (3) set of cards, money and happy emoticon puzzle. Details about the three set of cards are as below:

i. Set 1: Facial expression cards.

There are several cards that comprised of different types of facial expression.

ii. Set 2: Emotion word cards.

There are several cards that comprised of different emotion word for examples; sad, happy and angry.

iii. Set 3: QR code for video of emotional situation.

There are several cards that have QR code. Once the QR code is scanned, video of emotional situation will be played.

Figure 1: Emosihat the Emotion Board Game



The board is designed with 'gift' and 'sleepy emoticon'. These two symbols represent happy and stressful life event, respectively. Whereas, the other remaining box will be assigned number. This board game can be played by minimum of 2 players. By using dice, first player starts to play the game. The first player has to stop at a box based on to the number of the dice. If the player stops on the box that has number on it, he/she needs to open 1 card from set 1 and try to guess the type of emotion based on the facial expression shows on the card. If he/she able to identify the correct emotion, he/she will get RM10. Next, second player will take her/his turn. This will proceed until set 1 card is finished. Following that, set 2 will be open. For set 2, emotion word card, the player needs to explain about emotion trigger. For example, if the emotion word is 'sad', he/she needs to identify the reason that make he/she feels sad. If a relevant answer is given, she/he will get RM10.

After completing Set 2, Set 3 card will be open. For the set 3, QR code needs to be scanned and guess the emotion of the person in the video with possible emotion cues. If relevant answers are given, she/he will get another RM10. Once the player collects RM30, she/he can buy a puzzle. The first player completes the happy emoticon puzzle will be a winner. If the player stops at the 'giff' symbol, he/she will be given RM10, whereas, if he/she stops at the 'sleepy emoticon' symbol, he/she will not allow to open cards and get any money. If the player shows their anger, he/she needs to pay RM10. However, if he/she take a deep breath for several times to regulate their negative emotion, such as anger or sadness. The RM10 will be given back to them. This breathing technique is important to teach the children to regulate the negative emotion in their life.

Product Development

This board game is developed by using Canva. The basic skill that children need to learn is emotion labelling. Children should know the name of emotion they feel and label the emotion correctly. The importance of emotion labelling is to share or communicate about their emotion with others. Children will tend to express their negative emotion through negative behavior, for example tantrum, when they feel sad or angry. If children able to recognize and label the emotion, for example, when they feel sad, they can tell their parent 'I feel so sad', therefore, their parent can acknowledge their child's emotion and help their child to manage the emotion. In development of this board game, the Set 1 card is designed to help the children to understand different type of emotions, so that, they could recognize and label the emotion correctly.

A part from emotion labelling, the Set 2 card is developed to help the children to identify the emotion triggers. Emotion trigger is referred to various causes of feelings. Emotion triggers can be divided into external or internal. For external emotion trigger, feelings could be occurred in response to life events, such as success in English test, whereby, for internal emotion trigger, feelings occur based on children's belief and preferences. Children also can share the effects of different emotions on their bodies, for instance, they will experience heart racing, heaving breathing, feeling cold hands, sweating, trembling or dry mouth when they feel anxious.

The Set 3 card is designed to develop empathy skill. Children have to recognize, understand and feeling others' feelings through video. They need to watch the video and recognize the emotion of the actors in video of emotional situation by identifying the emotion cues. Emotion cues can be divided into external cues and situational cues. External cues can be identified based on facial and bodily signs of another person. In the absence of external cues, situational cues are important to understand how a situation may affect the person's feeling. Empathy skill helps children to appreciate others' feelings.

Moreover, in designing the board of this game, the 'giff' symbol and 'sleepy emoticon' to represent happy and stressful life event, respectively. Children will learn how to regulate their emotion while playing this game. A very simple breathing technique is applied to regulate their emotion. This breathing technique is very important for example, angry or anxious feeling will lead to fast breathing. Deep breathing technique will help them to calm down and control their emotion.

Contribution

Available board games in Malaysia not specifically target children to improve their emotion management skills. This board game is created to fill in the gap, in educating young children about emotion. Children, nowadays, exposed to many stressful life events, for example, during COVID-19 pandemic, they have to attend online class. They have to adapt with new norm, for example, PDPR (Pengajaran dan Pembelajaran di Rumah). Thus, this game will help them to label emotion by identifying different types of emotion through facial expression cards, understand about the emotions triggers through emotion words and improve their emotion management skills, such as, emotion regulation and empathy skills through emotional situation videos.

Advantages

This board game is intentionally to be a physical game not an online game like mobile apps game. This is because it will help the children to improve the motor skills and more importantly is to build parent-child secure attachment relationship. Parents could play this board game with their children to create high quality bonding time. Moreover, parents will know about their children through play, because their children with share their emotion as well as shows their emotion regulation and empathy skills while playing this board game. Furthermore, this game led to the healthy lifestyle among children since it enhances motor skills and create excitement environment.

Commercial Value

This board game promotes healthy learning culture through emotion management skills among children. The total number of children in Malaysia in 2020 was 9,2457 thousand. If each family has this board game, it could also be a tool to enhance quality time and bonding among family members who play together especially as weekend activity. Hence, this board game perhaps could lead to happiness among children thus minimized the risk of mental health problem.

References

Sahril, N., Ahmad, N. A., Idris, I. B., Sooryanarayana, R., & Abd Razak, M. A. (2021). Factors Associated with Mental Health Problems among Malaysian Children: A Large Population-Based Study. *Children* 2021, 8, 119. <https://doi.org/10.3390/children8020119>.

3D ANIMATION APPLICATION FOR THE COVID-19 QUARANTINE AND LOW-RISK TREATMENT CENTRE (PKRC) DEVELOPMENT

Siti Aisyah Muhammad

Faculty of Architecture and Ekistics, Universiti Malaysia Kelantan, 16300 Bachok, Kelantan
 aisayah@umk.edu.my

Tengku Fauzan Tengku Anuar¹, Nur Athmar Hashim¹, Nik Nurul Hana Nik Hanafi², Najah Md Alwi²

¹Faculty of Technology Creative and Heritage, Universiti Malaysia Kelantan, 16300 Bachok, Kelantan

²Faculty of Architecture and Ekistics, Universiti Malaysia Kelantan, 16300 Bachok, Kelantan

Highlights: The project aims to develop a platform of reference when converting the open spaces or massive hall to become a dedicated Covid-19 Quarantine and Low-risk Treatment Centre (PKRC) in facing the increase numbers of Covid-19 Category 1 and 2 in all over country. The findings of this study enhance our understanding of how a multi-functional space with a wise design can be successfully and easily transformed into the ideal spaces needed. Procedures and health policy were complied with during the space conversion, and the first Low Risk COVID-19 Quarantine and Treatment Centre (PKRC) can be a benchmark for guidelines to develop a fast and effective PKRC in the future.

Key words: Covid-19, PKRC, MAEPS, pandemic, conversion, corona

Introduction

MOH announced the Guideline of Quarantine Station (Guidelines COVID-19 Management No.5/2020 updated on 24 March 2020) whereby the establishment of a quarantine station is a requirement under Section 14 of the Prevention and Control of Infectious Disease Act 1988 (Act 342) (MOH, 2020). According to the Act, "The quarantine station is to be used for isolation or observation of any person who is infected or whom the Authorized Officer has reason to believe is infected to be removed to a quarantine station until the person can be discharged without posing any danger to the public" (2020). This involves the cooperation of multiple agencies such as the District Health Office, District Welfare Department, Malaysian Royal Police, Army, Local Council, PGA, and others. The successful recognition of MAEPS as a PKRC was therefore examined with a focus on space management and how the work was completed to fulfil the vision of the prime minister. This was to transform the convention hall into a PKRC with completed facilities and services similar to that of a hospital such as clinical services, a ward for COVID-19 patients, a pharmacy, X-ray room, resuscitation rooms to stabilise patients in emergency situations, and pathology laboratory services (interview with Encik Zaidi b Shahrim, CEO Mardi Corp., 2020). Since pandemic of Covid-19 reached Malaysia in 2020, there were about more than hundred PKRC established in Malaysia since second wave of pandemic in December 2020. In order to cater the emergency and ad-hoc duty in converting the public space such as the public hall, dormitory and stadium to become PKRC, this project aims to provide a template of the space layout for PKRC as the reference for the concerned persons.

Design development

The involvement and contributions of multiple agencies following the transformation of MAEPS to a PKRC is summarised in Figure 1 as an example of the agencies involved. All agencies stated in Figure 1 were provided with expertise in significant areas, resulting in the tremendous solution and successful spatial organisation and circulation of MAEPS as a PKRC.

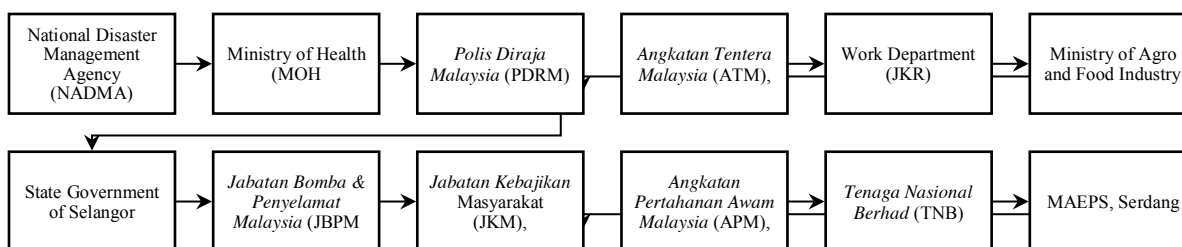

Figure 1: Work flow showing the contributions and execution of agencies involved in the transformation of MAEPS to PKRC (Mardi Corp., 2020)

A qualitative methodology was employed to achieve the objectives of this study. Secondary sources were examined to study the guidelines for the transformation process and the design characteristics of the MAEPS. The sharing of experiences illuminated the management and monitoring of all teams and the spaces needed. The data were analysed and the findings utilised to determine the factors underpinning the successful transformation of MAEPS in a short period of time into the first massive interim quarantine centre for Malaysia. The data then was developed into 3D modelling animation using AutoCAD, Sketch Up and V-Ray 3D Render (Figure 2).

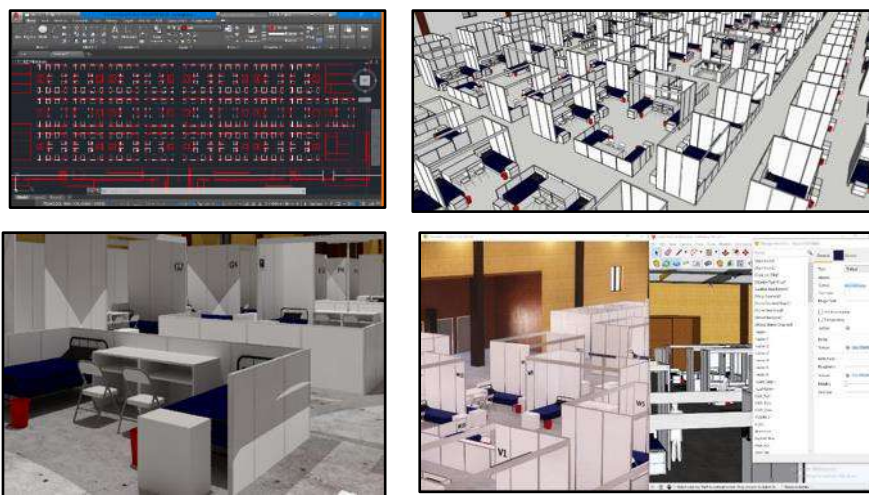

Figure 2: Developing 3D animation of PKRC hall of MAEPS using AutoCAD, Sketch Up and V-Ray

Innovation and Commercial Value

The 3D animation of the PKRC layout represented by PKRC of MAEPS can be used as a benchmark to all states in converting a public space to become a PKRC. The 3D animation works as a template for the related agencies to refer to in managing the space and arranging the layout to cater the low-risk patients of Covid-19. Due to understanding of the characteristics of Covid-19 virus increasing day by day, the layout of PKRC also has several amendments such as the use of partition between the cubicles (Figure 3). Thus, it is resulting in two types of PKRC layout and both can be a valuable reference for the future. PKRC is only allowed to be entered by the front responders and patients only, therefore this 3D animation also contributes in giving the information of the ambience of Covid-19 quarantine and low-risk treatment centre in Malaysia to the public.



The 3D animation of the PKRC also contributes in education through the explorative space layout animation that can be referred to in classroom and research as the PKRC is a temporary space which only develops during pandemic at its peak. The 3D animation of the PKRC also explains about the historical moments of Malaysian facing the pandemic of Covid-19 that can make our future proud. This 3D animation can be developed further to be used as Augmented Reality and Virtual Reality in future.

Acknowledgement

The authors acknowledge the Research, Innovation and Commercialisation Center (RMIC), Universiti Malaysia Kelantan for supporting this project under the UMK Covid-19 Special Grant (UMK-C19SG) R/C19/A1200/00554A/003/2020/00775).

References

- Jabatan Kerja Raya Malaysia. (2020, April 8). *Kepakaran Fasiliti Kesihatan Dan Teknikal Jabatan Kerja Raya Malaysia Berjaya Merealisasikan Maeps Sebagai Pusat Kuarantin Dan Rawatan Covid-19 Berisiko Rendah Dalam Tempoh 3 Hari*. Retrieved Ogos 13, 2020 from Blog Jkr Malaysia: <https://jkrmalaysia.wordpress.com/2020/04/13/kepakaran-fasiliti-kesihatan-dan-teknikal-jabatan-kerja-raya-malaysia-berjaya-merealisasikan-maeps-sebagai-pusat-kuarantin-dan-rawatan-covid-19-berisiko-rendah-dalam-tempoh-4-hari/?fbclid=IwAR1kyhw4v2rgycmmlnb>
- Kementerian Kesihatan Malaysia. (2020, August 6). *Covid-19 Malaysia*. Retrieved August 11, 2020 from Garis Panduan Kementerian Kesihatan Malaysia: http://Covid-19.Moh.Gov.My/Garis-Panduan/Garis-Panduan-Kkm/Annex_1_Case_Definition_Covid_22032020.Pdf
- Mardi Corp. (2020) *Pusat Kuarantin & Rawatan Covid-19 Berisiko Rendah MAEPS, Serdang* (Unpublished article)
- Personal interview with CEO of Mardi Corp., Encik Zaidi Shahrin (8 Sept 2020), MAEPS, Serdang

SMART JACKET: A MULTI-UTILITY TRAVEL JACKET FOR TRAVELLERS

Muhammad Azam Aziz

Universiti Malaysia Kelantan, Kota Bharu, Malaysia
azam.h18a0253@siswa.umk.edu.my

Muhammad Asyraf Najmi Azmi, Najwa Izzani Laili, Noor Syazwani Narzuwan, Murni Husna Muhamad Jehka, Sangeetha Sangkar, Previna Vijayan, Ng Huoi Hsian, Nik Alif Amri Nik Hashim

Universiti Malaysia Kelantan, Kota Bharu, Malaysia
alifamri@umk.edu.my

Highlights: A smart jacket, which is a jacket that communicates with electronic devices is the latest invention in wearable technology and comes with wireless connectivity. The smart jacket lets users control mobile devices through Bluetooth easily while doing other activities. This jacket is unique because it has two functions that can control the temperature and massage the wearer by reducing the wearer's body temperature and perspiration as well as providing a massage to the wearer's tired back muscles. In addition, this jacket offers water and wind resistance. Developers expect the jacket to be especially popular among travellers who may find the technology easier to use than a smartwatch. The smart jacket's main focus is to help its wearers solve everyday problems derived from distractions caused by fiddling with electronics and other smart devices. The smart jacket also gives benefits to travellers who wear this multifunction jacket. The massage service is connected to the phone and the travellers can use it easily, hence reducing their body pain at any time and any place. This smart jacket also provides an air-conditional service for the travellers, which changes according to the weather such as cool and hot. The air-conditioned smart jacket reduces the wearer's body temperature and minimizes perspiration, making this technology quite environmentally friendly as it decreases the necessary use of indoor AC systems.

Key words: *innovation, smart jacket, electronic devices, tourism.*

Introduction

Smart Jacket, which is made of fabric is both wind and water-resistant with adjustable sleeves. The wearable jacket is another one of those fashion technologies that has come up in the fashion market. It does not burden one's body and is very comfortable when worn. Smart Jacket is perfect for travellers and those who are always going on a trip. This jacket also matches the brutal temperature because the jacket feature has a temperature that depends on the weather or one's desired comfort. The great thing about using this product is that it has a machine that provides a massage feature that can help relieve back pain, alleviate shoulder aches, and promote weight loss. In addition, this product is suitable for any age and available for both men and women. In fact, having a good quality product is a must in many countries.

However, the problem is for travellers who go abroad that takes more than 8 hours. Due to long journeys, tourists will experience jet lag or fatigue. This problem statement is specifically for tourists who board a plane or go to a destination that takes up to 8 hours of travel time. Tourists will experience jet lag and, as a result, they may lose the desire to travel or require additional time to relax before travelling to the desired destination. Therefore, this innovative jacket can assist in resolving the tourists' problem.

Students are encouraged to explore, research, and use all of the tools available to learn something new through innovation in education. This involves a different way of looking at problems and solving them. Students will be able to improve their creativity and problem-solving skills as a result of the thought process involved. Furthermore, innovation can also benefit education by encouraging students to solve problems through a higher level of thinking. In this regard, we can see how product innovation can help students think creatively and innovatively. Therefore, the ability of students to think creatively in order to produce an innovative product that can assist people in the use of new technologies such as the Smart Jacket can be enhanced.



Picture 1: The prototype of the Multi-Utility Travel Jacket for Travellers

The advantage of our product is that it can respond to changes in the temperature and create an individual "microclimate" for its wearer. Moreover, it has a massage feature that can help its wearer relieve back pain, alleviate shoulder aches, alleviate sprain caused by stagnated blood, and helps burn fat and promote weight loss to those who aim to lose a few inches. This jacket also uses a trendy design that is suitable for its wearer of any age.

The smart jacket, which combines massaging and air-conditional features, help travellers to relax while travelling. When travelling, travellers will feel tired and the massaging feature can help them relax, especially by reducing back pain. Besides that, the smart jacket has an air-conditional service that can help the travellers control the temperature. When travelling, the weather is mostly hot; hence, the air conditional feature can help the travellers control the temperature to become cool. On the contrary, the travellers can also use the air conditional feature to control the temperature to become hot when the weather is rainy and cool.

Acknowledgement

We have taken a lot of effort into this project. However, completing this project would not have been possible without the support and guidance of a lot of individuals. We would like to extend our sincere thanks to all of them. We are highly indebted to Dr. Nik Alif Amri Bin Nik Hashim for their guidance and mentoring. We would like to thank him for providing their invaluable guidance, comments and suggestions throughout this project. Our thanks and appreciations also go to our group mates in developing the project. Thank you to all the people who have willingly helped us out with their abilities.

References

- Kim, S., Roh, J. S., & Lee, E. Y. (2016). Development and wearability evaluation of all fabric integrated smart jacket for a temperature-regulating system based on user experience design. *Fashion & Textile Research Journal*, 18(3), 363-373.
- Waterhouse, J.A., Edwards, B., Nevill, A., Carvalho, S., Atkinson, G., Buckley, P., & Ramsay, R. (2002). Identifying some determinants of "jet lag" and its symptoms: a study of athletes and other travellers. *British Journal of Sports Medicine*, 36(1), 54- 60.

MODISH TRAVEL HEATER: THE INNOVATION OF NIMBLE TIFFIN

Nor Dalila Marican

Universiti Malaysia Kelantan, Kota Bahru, Malaysia
daila.m@umk.edu.my

Aifaa Syazwani Abdul Razak, Nurfarisha Fauzi, Nurul Najwa Nasuha Muda, Syazwani Sahwandi, Syed Muhammad Izzat, Nur Farah Wahida Saidi, Nur Nabilah Husna, Nurul Farhana Mohd Hanafi, Fatin Afikah Talib, Fatin Shahirah Sholahudin

Universiti Malaysia Kelantan, Kota Bahru, Malaysia
aifaa.h18a0022@siswa.umk.edu.my, farishafauzi9811@gmail.com, najwa.h18a0500@siswa.umk.edu.my,
syazwanisahwandi@gmail.com, izzat.h18a0625@siswa.umk.edu.my, wahida.h18a0708@siswa.umk.edu.my,
husna.h18a0770@siswa.umk.edu.my, farhana.h18a0484@siswa.umk.edu.my, fatinafikahatalib@gmail.com,
shahirah.h18a0124@siswa.umk.edu.my

Highlights: Modish Travel Heater is designed to reheat or keep food warm, delicious, and safe which can be used by travellers when they are travelling. Modish Travel Heater is suitable for use when traveling, especially during the current COVID-19 pandemic. Modish Travel Heater also can avoid the traveller to go to the crowded place just to eat because this product can help them reheat the food they bring from home. The purpose of innovating this Modish Travel Heater is to convenience the travellers to enjoy their warm food during their journey. This product is enhanced by using products namely 3-layer container, temperature display, container using 3 layers of material, capacity of 1.5 litres, 6 attractive designs and thermal bag with 7 layers types of material and can be used with adapter and USB.

Key words: Reheat, Food warm, travelers, COVID-19 pandemic, convenience, and journey.

Introduction

The rapid spread of COVID-19 was facilitated by air travel. Current evidence suggests that the virus spreads mainly between people who are in close contact with each other, typically within 1 metre (short-range). Because of the current situation in Malaysia, all travellers may be at risk for getting and spreading COVID-19 variants. Combating COVID-19 will require all travellers to apply social distancing by avoiding crowds and stay at least 6 feet or 2 meters from anyone who did not travel with them. Eating out in restaurants during traveling is an activity that commonly done by travellers. As we can see, most of the travellers are struggling to follow the SOP (Standard Operating Procedure) to go out especially in crowded place such as rest area and the restaurants. However, it is advised by experts to not eat food from outside and cook at home as much as possible to prevent the travellers from getting the virus. Transporting hot food and keeping it warm can be a challenge. Therefore, a Modish Travel Heater is designed to reheat or keep food warm, delicious, and safe to eat until the traveller reaches the destination.

Description of Modish Travel Heater

From the outside of Modish Travel Heater, it can be seen as ordinary tiffin carrier that we can get in any physical store or through online platforms. However, there is one feature that makes Modish Travel Heater completely different from any other tiffin carrier in the market. Modish Travel Heater comes with 3 layers heated food container that can warming up the food at the same times. Modish Travel Heater provides enough heat to not just maintain the temperature of already hot food but can also reheat food. With this awesome feature it does saves time for the consumer of this product. This Modish Travel Heater utilize power bank as the power distributor as well as type-c wire in order to function.

Background of the Innovation

Eating outside during travelling caused the problematic experience in this COVID-19 pandemic because COVID-19 can spread easily if there is no social distancing and also in the crowded place. Keeping warm food while traveling can be tricky because the food can get cold quickly. To put it simply, hot foods must stay hot (above 140°F) and cold foods must stay cold (below 40°F). When foods are held between 40 and 140°F, bacteria can grow rapidly to levels that can cause sick. This temperature range is called the "danger zone" and should be treated. There is no convenient tiffin heater with USB charging and so that Modish Travel Heater comes with the future which is the tiffin food can be heated easily and simultaneously.

The Importance of Modish Travel Heater

Modish Travel Heater is environmentally friendly. The reusable container and long-lasting utilization can reduce the use of kitchen appliances needed during traveling. Safety is also the important thing for Modish Travel Heater consumers with heat and electricity resistor around food container's body and the handle. Switch on off also was provided with the LED make it more convenient to control when it's time to enjoying the food or wash. Other than the use of USB wire, three compartments can be reheating the food without the electricity once take off the plug because there is battery charging power. Traveller just need to make sure it was charged in advance then can reheat food anytime. It easy to operate, inexpensive and can be quickly mobilized due to the lightweight design.

Advantages of Modish Travel Heater

Modish Travel Heater advantage can prevent from getting the COVID-19 and spreading it. Traveller need to reduce the risk of infection by using this product with heating it in the car using a USB wire or charge the battery in advance without having to go to a restaurant and crowded with people just to get a hot food. Then, it can maintain cleanliness and proper food hygiene. Everything is prepared by themselves and there is no need to worry about finding a restaurant if consumer is hungry during the driving period. Modish Travel Heater high quality materials preserve the freshness and quality of food. The uses of high-temperature resistant can guaranteed food safety and extends the life of the food.

Commercial Value of Modish Travel Heater

Modish Travel Heater practically convenient especially for travellers because of compact design and lightweight make it easy to carry anywhere and travel-friendly. Various fancy design can attract the younger travellers to buy it. People will definitely spend their school holidays by going on tours and Modish Travel heater can get highly demand especially during school or long holiday. Other than that, the uniqueness is the use of electricity instead of flames. It has a direct current to plug it in anywhere including in the car and the battery can be charged once it has been drained. This function is very convenient because travellers usually do not have electric facilities at all the times. Reasonable price for long-lasting product giving the opportunities to all people whether low or high incomes groups

Acknowledgement

We are grateful for financial support from the Global Entrepreneurship Research & Innovation Centre (GERIC), Universiti Malaysia Kelantan

References

- Anderson, N. (2003). Technology assessment: technology viable to keep" take-home" food warm for 30 minutes.
- Carothers M. (2018). Your Holiday How-To: Keeping Hot Foods HOT and Cold Foods COLD. Retrieved from <https://www.foodsafety.gov/blog/your-holiday-how-keeping-hot-foods-hot-and-cold-foods-cold>
- Centre for Disease Control and Prevention (2021). How to Protect Yourself & Others. Retrieved from <https://www.cdc.gov/coronavirus/2019-ncov/prevent-getting-sick/prevention.html>
- Heck, A. (2021). Safest Non-Toxic Food Storage Containers. Retrieved from <https://thegoodlifedesigns.com/non-toxic-food-storage-containers/>
- Johnson, A. (2021). Portable Food Warmer Can Heat Leftovers in the Car. Retrieved from <https://www.wideopeneats.com/portable-food-warmer/>
- Kline, S. J., & Rosenberg, N. (2010). An overview of innovation. Studies on science and the innovation process: Selected works of Nathan Rosenberg, 173-203.
- Marlin Steel (2021). What is the Best Food Grade Stainless Steel? Retrieved from <https://www.marlinwire.com/blog/what-is-the-best-food-grade-stainless-steel>
- Pandit, R. B., Somavat, R., Jun, S., Heskitt, B., & Sastry, S. (2007). Development of a Light Weight Ohmic Food Warming Unit for a Mars Exploration Vehicle. World of Food Science, 2, 1-12
- Sanap, N. B., Mate, D. M., & Kathwate, S. D. (2018). Design, analysis and performance evaluation of hybrid exhaust gas heat recovery device to keep food delivery items warm. International Journal for Advance Research and Development, 3(5), 44-56.
- The Independent (2011). Time for Tiffin. Retrieved from <https://www.independent.co.uk/lifestyle/food-and-drink/features/time-tiffin-5356146.html>
- Wong, K., & Heacock, H. (2014). Fitness lunch bag. BCIT Environmental Public Health Journal.
- World Health Organization (2020). Coronavirus disease (COVID-19): How is it transmitted? Retrieved from <https://www.who.int/news-room/q-a-detail/coronavirus-disease-covid-19-how-is>

PROTOTYPE SNEAKER INSOLES SENSOR

Woo Wai Yee

University Malaysia Kelantan, Kota Bharu, Malaysia
Wwyee.h18a0671@siswa.umk.edu.my

Chan Kit Min, Chiang Zhi Ying, Hoo Jia Ming, Wong Pei See, Chin Chi Fung Tiew Yee Shan, Tchey Guat Nee, Pn.Fadhilahanim Aryani Binti Abdullah, Dr.Derweanna Binti Bah Simpong, Mohd Hafzal Bin Abdul Halim

University Malaysia Kelantan, Kota Bharu, Malaysia
Wwyee.h18a0671@siswa.umk.edu.my

Highlights:: By wearing sneaker insoles, people's lifestyle quality becomes healthier. The more steps you have, the healthier you are. Therefore, everyone can have this insole. Our innovative sneaker insole mainly counts the number of steps. In addition, it also helps to reduce foot fatigue. Innovative sneaker insoles are formulated with comfortable materials, especially for people with flat feet and obesity problems. In addition, we also launched a premium insole, which contains alarm sensors and thermal insulation materials. This comfortable and convenient sneaker insoles concept is with the customer's brain, which we prepare for you.

Key words: sneaker insoles, healthier, number of steps, alarm sensors, thermal insulation material

Introduction

In this 21st century, science and technology are rapidly changing the world. Sneaker insole sensor has many differences with typical smart gadgets. There are some functions and benefits of our product. Cooperation with target stakeholders, let more people know our products. We have to provide a high-quality standard of sneakers insole sensor product that is needed to all customers. To develop dealings that make a positive difference in our customer's lives. We provide first-class customer service with value for money sneakers insole sensor products to satisfy our customers. At the same time to produce stylish and comfortable athletic shoes, combined with our products, multifunctional athletic sneaker insoles. Our sneaker insoles boast excellent quality and smart features that are also suitable for all ages people. Make it possible for all to buy and maintain good health.

Content

Sneaker insole is a count footstep sensor, more accurately about your steps to indicate your running biomechanics. The electronic digital screen shows the footsteps count, and it has a magnet sewn on the tongue to detect the insole. This excellent sneaker is for all ages of customer segment such as traveller, high income, active sportsman, Obese, and flat-foot person. Innovative sneaker insoles are formulated with comfortable materials and provide customized designs, colours, and sizes, especially for people with flat feet and obesity problems—this product battery-free but also waterproof. This innovation also has linkage with some brands such as Nike, Adidas, Puma, and others to fulfil what customers want to wear. We also launched a premium insole containing alarm sensors and thermal insulation materials that keep your feet dry and warm. This comfortable and convenient sneaker insoles concept is 'with the customer's brain, which we prepare for you'. After purchasing the product, will be given a QR code for people to install an application on their mobile phone to know the steps they walk and locate the shoes when it has gone.

The reason to innovate sneaker insole because many people have trouble with suitable shoes, especially a person who has a flat foot, having a standing posture problem, obese person, and standing or walking for a long time caused by foot pain. Smartwatches also cannot count steps accurately. Hence, the advantage of this innovative sneaker insole helps to reduce foot fatigue, ensure the flat foot user walks with a good posture and comfortable, more accurate to calculate the step and record the step easily. Besides that, insoles keep your feet warm and toasty, suitable for extremely cold conditions. Thermal insoles are usually highly absorbent, removing the moisture off of your feet quickly.

The process has three-stage, mapping impact value, measuring intended impact, and monitoring and evaluating progress to success this innovative product. For commercialization, we have collaborated with sneaker brand shops such as Nike, Adidas, Puma, etc. Next, sell this health sneaker in the hospital and promoting through social networking. Therefore, this is a great sneaker insole for all people. Sneaker insole suitable for people who love hiking, travelling and jogging, because it can help them to record the steps they walk and sneaker insole can warm the feet inside the shoes.



Acknowledgement

Gold awards in Beginner Innovation Exhibition and Entrepreneurship (BIE). Best video award in Beginner Innovation Exhibition and Entrepreneurship (BIE).

References

The CyberShoe: A Wireless Multisensor Interface for a Dancers Feet - Scientific Figure on ResearchGate. Available from:
https://www.researchgate.net/figure/Diagram-of-the-instrumented-shoe_fig1_2365404

Nagano H, Begg RK. Shoe-Insole Technology for Injury Prevention in Walking. *Sensors*. 2018; 18(5):1468. <https://doi.org/10.3390/s18051468>

AVOCADO EL CABELLO OIL (NATURAL HAIR SERUM)

Fadhilahanim Aryani Abdullah

Universiti Malaysia Kelantan
Aryani.a@umk.edu.my

Naziatul Aziah Mohd Radzi, Nur Farah Nabilah Aina Ruslan, Nurafyrra Joha, Maryam Sahla Che Mohd, Kaiyisah Mohd Apani, Nurin Aqilah Natasha Rosli, Haida Misnon, Izni Zulaikha Kamarezaman, Norazni Azikin Norhisham, Nur Syuhaida Safiee

Faculty of Hospitality, Tourism and Wellness, Universiti Malaysia Kelantan
aziah.mr@umk.edu.my, nabilah.h18a0375@siswa.umk.edu.my, afyrra.h18a0437@siswa.umk.edu.my,
maryam.h18a0208@siswa.umk.edu.my, kaiyisah.h18a0159@siswa.umk.edu.my, aqilah.h18a0451@siswa.umk.edu.my,
haida.h18a0737@siswa.umk.edu.my, zulaikha.h18a0690@siswa.umk.edu.my, azni.h18a0331@siswa.umk.edu.my,
syuhaida.h18a0431@siswa.umk.edu.my

Highlights: This hair condition is more common in women, who must take special care of their hair to prevent it from falling out. Perhaps this is not a concern for veiled women, but it is for non-veiled women who must maintain their appearance neatly and meticulously. Stress, insufficient sleep, unstable emotions, a lack of vitamin, an unhealthy scalp, the use of improper shampoo, and poor diet are the primary causes of hair loss, dandruff, and dry hair. Avocado El Cabello Oil (Natural Hair Serum) is the solution to this issue. This product is incredibly thorough because each component is beneficial to people who have hair loss issues. Avocado El Cabello Oil's main benefit is that it strengthens hair roots and encourages hair growth. We also believe that the worth of a product may be determined by its ease and familiarity packaging, as well as its capacity to solve problems.

Key words: *Natural Hair, Hair condition, Avocado El Cabello Oil, Hair roots, Scalps, Hair Loss*

Introduction

Hair is an integrated system with strange chemical and physical behaviours. It is a complex structure of several morphological components that act as a unit. The lipid content of the cell surface decreases with repeated rough washing, unprotected drying, frictional action, sunshine, and alkaline chemical treatment, converting it from a hydrophobic to a more hydrophilic and negatively charged surface. Everyone in the beauty industry appears to have a story about hair difficulties. There are numerous fantastic hair products on the market that provide natural and clean ingredients to help maintain healthy hair. The use of suitable hair care products can help to limit, avoid, or repair hair damage caused by chemical processes.

Content

Description of the innovation product development

Avocado El Cabello Oil with rich the protein as hair fall solution can nourishing, strengthens and improves hair as well as reduces split ends with natural ingredients of extract avocado, wheat germ and castor oil will treat damage hair. Sakura Blossom Japanese fragrance give the long-lasting smell and make people comfort every day. This product also has a Vitamin E which can help to improve overall scalp and hair health. Peppermint essential oil is beneficial to the hair and scalp. It relieves dryness, irritation, and other scalp issues. The rosemary essential oil in this product might be beneficial to persons who suffer from hair loss. Rosemary is both a medicinal and a culinary herb (White, 2019). Tea tree essential oil can assist with a variety of diseases, including hair loss (Boulton, 2020). By using diluted tea tree oil along the shaft of the hair can help to avoid the development of chemicals and dead skin (Santiago, 2020). For design, it also contains some of the tools required to create this product. Plastic Duck Pump Bottles (for portability and ease of use) with Brand Stickers for branding.

The context of the innovation

There have a few contexts or as background of the innovation. First and foremost, main product innovation of Avocado El Cabello Oil is Avocado itself. This is because avocado is good to healthy hair especially hair loss problem. It also is a great source of vitamins E, C, K and B-6, as well as riboflavin, niacin, folate, pantothenic acid, potassium and magnesium. They also provide lutein and omega-3 fatty acids. Next, natural ingredients can find in our product is one of the innovation or background of product. This is because we try to make a product especially for healthy hair no chemical or things not good for people went consume this product. Furthermore, this product is suitable for both gender which is men and women. It is because this product is natural so it is safe for them to use. Then, the packaging of this product is in the small bottle. It easy to people who consume our product to bring anywhere they going.

Importance to education

Avocado El Cabello Oil is product that had created to give benefit for people. There are a few reasons why this product is important to education. First, this serum is important to education because want to encourage people to know about the importance of hair care at a young age. This is because, when take good care of hair at a young age, then when age is getting older, people do not have to worry about their hair because have been practiced good hair care when at a young age. Second, want to improve the student talent and skills to innovate a product and market their product to a wider market. From this, they can have the opportunity to make a business from this innovative product for their own benefit and others too. Third, people can solve their own hair problems at home on their own because of the exposure of natural ingredients to take care and solve their hair problems. In this way, people can save their money, time and energy. This ingredient they can find at home and surrounding researcher. Last but not least, Promote enhanced and diversity of product hair care products with existing information. In this way, it can make it easier for the people or others researcher to combine the new information and innovation development hair product with existing information.

Advantages of the innovation

The advantage of product development to education and community is that it gives students the opportunity to develop knowledge and experience in the field of product innovation. In addition, students can generate income by conducting sales activities of these products in the market as well as being able to train themselves in business. Therefore, students can also carry out research and development (R&D) activities in the field of innovation and business. This will increase the knowledge of students in performing in their daily life activities. For the community, it is possible to provide a way out for anyone from various groups of men or women, whether children, teenagers or adults who suffer from hair loss to have healthy and beautiful hair. In addition, this product is very suitable to be used by the community because of its flexible design where users can easily carry it wherever they are. In turn, this product will provide various benefits to the community who have serious hair problems where this product will provide healthy and beautiful hair when outdoors. In short, this product provides an effective and positive impact on both the creators and consumers to gain their respective profits.

Commercial value in terms of marketability or profitability of innovation

Based on the products that had released, among the commercial values that can be seen is in terms of the design having a price in the market. Product design is an activity of production and creation of products to meet human wants and needs. Before a product is release the manufacturer needs to know the important features that must be present in the product such as hair spray serum. To make it easier for users to apply for a short time. In addition, the product can be sold and used by consumers. As a manufacturer, we need to produce a product that can benefit consumers and ensure that the product is always quality and can satisfy customers. Indirectly, regular customers will exist and additional customers also exist as a result of promoting to each other. Finally, the product can meet the tastes and desires of customers. This concept of value usually exists based on a consumer's perception of a product offered. Customer satisfaction depends on the ability of a product to achieve the expectations expected by consumers of a product such as a convenience and reliability. Indirectly, engaging customer trust is increased.

References

- Boulton, J. (2020, September 14). *Tea tree oil: Uses and benefits* . Retrieved from www.companynewshq.com:
<https://www.companynewshq.com/company-news/retail-company-news/tea-tree-oil-uses-and-benefits-holland-barrett/>
- Santiago, A. D. (2020, July 23). *Brush Up on Rosemary Oil for Hair Growth*. Retrieved from greatist.com:
<https://greatist.com/health/rosemary-oil-for-hair>
- White, A. (2019, April 16). *healthline.com*. Retrieved from *Should I Use Rosemary Oil for Hair Growth?*:
<https://www.healthline.com/health/rosemary-oil-for-hair>

PROPOSING A CONCEPTUAL MODEL OF DESTINATION LOYALTY: TWO PARALLEL MEDIATORS OF PLACE ATTACHMENT AND TOURIST MOTIVATION

Muhamad Nasyat Muhamad Nasir

Universiti Malaysia Kelantan, Kota Bharu, Kelantan, Malaysia
nasyat.mn@umk.edu.my

Marlisa Abdul Rahim, Siti Fariha Muhamad

Universiti Malaysia Kelantan, Kota Bharu, Kelantan, Malaysia
marlisa@umk.edu.my, fariha@umk.edu.my

Highlights: This study proposes a new comprehensive conceptual model consisting of involvement, place attachment, tourist motivation that could be implemented to improve tourist loyalty among domestic tourists visiting Kelantan. This model comprises two parallel mediators that will be tested using the phantom approach model. This model is considered an innovation in mitigating tourist loyalty issue.

Key words: Destination loyalty, Parallel mediators, Involvement, Tourism Kelantan.

Introduction

The tourism destination in Kelantan is experiencing among the least number of domestic visitors arrivals and receipts in Malaysia (Department of Statistics Malaysia, 2019). Hence, this issue can be solved by improving destination loyalty among domestic visitors to Kelantan since loyal tourists will demonstrate repeat visits (Prayag et al. 2017) and spread positive word of mouth to the other potential tourists (Cheng et al., 2016). Involvement (Di-Clemente, 2020), tourist motivation (Gurbaskan Akyuz, 2019) and place attachment (Hosany et al., 2017) were found to be appropriate predictors to gauge destination loyalty. When the tourists start to be loyal to the tourist destination, it will increase the number of domestic arrivals to Kelantan. They also tend to spend more during their trip, which could increase tourist receipts in Kelantan. Therefore, this study introduces a new conceptual model by testing the interrelationships between involvement, tourist motivation, place attachment, and destination loyalty. Most importantly, this study will test two parallel mediators, namely, tourist motivation and place attachment, simultaneously using the phantom approach.

Content

Figure 1 highlights the proposed new conceptual model whereby involvement and destination loyalty are the independent and dependent variables respectively. Meanwhile, place attachment and tourist motivation are parallel mediators.

Figure 1: Proposed Conceptual Model

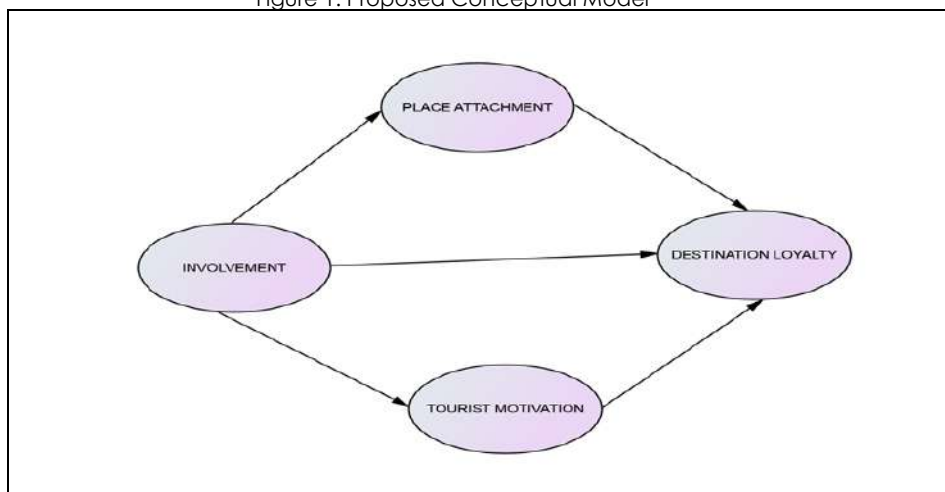

Several past studies in tourism research such as Lee & Shen (2013), Xu & Zhang (2016), Hosany et al. (2017), Song et al. (2017), Chen (2018), Yuan et al. (2019), Gurbaskan Akyuz (2019), Di-Clemente (2020) and Japutra (2020) have investigated these four constructs. However, these constructs have been investigated separately, and none of past studies has tested and compared parallel mediators of place attachment and tourist motivation using a phantom model. Thus, this study integrated these four constructs in one model to be tested and compared parallel mediators of place attachment and tourist motivation using the phantom approach model. The present study provides new insight into which aspect the scholars should focus on whenever they have confirmed the model with the empirical data. Furthermore, the proposed model provides a platform for future researchers to extend the model in future research. This model also serves as a guideline, especially to the local community and tourism management in Kelantan, to improve the level of loyalty of domestic visitors to this state. Based on this model, the stakeholders would notice that encouraging tourists to be involved in local activities and consuming tourism products and services could lead to positive or negative feelings on their overall trip experience to Kelantan. It is expected that highly involved/participated tourists would develop a strong personal connection between tourists and the destination. Highly involved tourists also are expected to be more motivated. Consequently, the tourists will be more loyal to the destination by spreading positive word of mouth and revisiting Kelantan soon. This model has high commercial value, especially when researchers intend to understand the predictors that affect destination loyalty. This model also compares the effect of two mediators (place attachment and tourist motivation) using the phantom approach, which rarely past models proposed this test. So, this model will be highly demanded by the stakeholders in the tourism industry.

References

- Chen, C. Y. (2018). Influence of celebrity involvement on place attachment: Role of destination image in film tourism. *Asia Pacific Journal of Tourism Research*, 23(1), 1-14.
- Cheng, J. S., Shih, H. Y., & Chen, C. H. (2016). Festival revisiting intention and quality: The case of Taiwan's Lantern Festival. *Universal Journal of Management*, 4(10), 575-580.
- Department of Statistics Malaysia (2021). Domestic Tourism Survey by State 2019. Retrieved on 14 July 2021 from [Department of Statistics Malaysia Official Portal \(dosm.gov.my\)](http://Department of Statistics Malaysia Official Portal (dosm.gov.my))
- Di-Clemente, E., Hernández-Mogollón, J. M., & Campón-Cerro, A. M. (2020). Tourists' involvement and memorable food-based experiences as new determinants of behavioural intentions towards typical products. *Current Issues in Tourism*, 23(18), 2319-2332.
- Gurbaskan Akyuz, B. (2019). Factors that influence local food consumption motivation and its effects on travel intentions. *Anatolia*, 30(3), 358-367.
- Hosany, S., Prayag, G., Van Der Veen, R., Huang, S., & Deesilatham, S. (2017). Mediating effects of place attachment and satisfaction on the relationship between tourists' emotions and intention to recommend. *Journal of Travel Research*, 56(8), 1079-1093.
- Japutra, A. (2020). Building enduring culture involvement, destination identification and destination loyalty through need fulfillment. *Tourism Recreation Research*, 1-13.
- Lee, T. H., & Shen, Y. L. (2013). The influence of leisure involvement and place attachment on destination loyalty: Evidence from recreationists walking their dogs in urban parks. *Journal of Environmental Psychology*, 33, 76-85.
- Prayag, G., Hosany, S., Muskat, B., & Del Chiappa, G. (2017). Understanding the relationships between tourists' emotional experiences, perceived overall image, satisfaction, and intention to recommend. *Journal of travel research*, 56(1), 41-54.
- Song, H. M., Kim, K. S., & Yim, B. H. (2017). The mediating effect of place attachment on the relationship between golf tourism destination image and revisit intention. *Asia Pacific Journal of Tourism Research*, 22(11), 1182-1193.
- Xu, Z., & Zhang, J. (2016). Antecedents and consequences of place attachment: A comparison of Chinese and Western urban tourists in Hangzhou, China. *Journal of Destination Marketing & Management*, 5(2), 86-96.
- Yuan, Q., Song, H., Chen, N., & Shang, W. (2019). Roles of tourism involvement and place attachment in determining residents' attitudes toward industrial heritage tourism in a resource-exhausted city in China. *Sustainability*, 11(19), 5151.

THE VALUES OF HEROISM IN *TOK TANGOK* FOLKLORE AS A SYMBOL OF PERSONALITY AND IDENTITY OF MALAY COMMUNITY: RESEARCH ON THE PERCEPTION STUDENTS IN UNIVERSITY MALAYSIA KELANTAN THROUGH *KAHOOT* APPLICATION

Mohd Firdaus Che Yaacob

Universiti Malaysia Kelantan, Bachok, Malaysia
firdaus.cy@umk.edu.my

Muhammad Nur Al-Hakim Mohamad Hanafiah, Tuan Siti Nurul Suhadah Tuan Adnan

Universiti Malaysia Kelantan, Bachok, Malaysia
alhakim201@yahoo.com, sitiinurulsuhadahadnan@gmail.com

Highlights: Legend tells of the greatness of character and place in the Malay community in the past. This study aims to identify and analyze the value of heroism by Tok Tangok as a symbol of individuality and identity of the Malay community based on the perception of the students in University Malaysia Kelantan through Kahoot applications. The design of this study is qualitative, library, field, and questionnaire methods. The findings prove that the legend Tok Tangok have the heroism that was practiced by the Malay community as a symbol of individuality and identity of the Malay race superior.

Key words: *Heroism Values, Legendary Stories, Perception, Students in University Malaysia Kelantan, Kahoot*

Introduction

The legendary story is told orally by the story teller and is detailed as a form of story to show about the history of the characters and places that have happened in the past. Halimah Hassan (1989) argues that legends are described as 'history' collectively. accordingly, through the presentation of the legendary story, contained a wealth of heroic values by the supporting characters. These values of heroism can be observed from the point of view of one's behavior and the speech style of a figure in defending something that is true (Noviatin Syarifuddin, 2016).

Literature Review

A study conducted by Muhammad Nur Al-Hakim Mohamad Hanafi Mohd Firdaus Che Yaacob (2020) is based on *Islamic Values and Morals Formation in Malay folklore*, Tuan Siti Nurul Suhadah Tuan Adnan and Mohd Firdaus Che Yaacob (2020) conducted a study entitled *The Oral Narrative Wisdom of the Residents of Kota Bharu, Kelantan: A Community Study, Reflection of Islamic Values in the Collection of 366 Malaysian Folktales: A Takmilah Approach* was also conducted by Muhammad Nur Al-Hakim Mohamad Hanafiah & Mohd Firdaus Che Yaacob (2021) and the discovery of the corpus of folklore studies conducted by Mohd Firdaus Che Yaacob (2021) entitled *Values In Legendary Stories In Pengkalan Datu River Basin, Kelantan*.

Problem Statement

This study is conducted that the author takes into account the views of the community who think that the legendary story is a purely fictional story, full of imagination, superstition and merely entertainment. Negative perceptions in society should be brushed aside to ensure that the heritage of our ancestors is preserved and preserved and passed on to future generations. Thus, the documentation and dignification of the legendary story should be carried out.

Significance Of The Study

This research is important to the community to dispel negative perceptions of folklore who is said to be beneficial, foreign and purely imaginary. This study highlights the importance of the application of Kahoot in the delivery of folklore to students in University Malaysia Kelantan.

Research Methodology

Researchers have used qualitative research methods involving library, field and questionnaire methods. This study takes the approach through the framework of Folklore by Dundes (1965) which is divided into three aspects, namely identification, data collection and data analysis. This study selected Encik Muhd Rawi Jusoh in Kampung Rusa, Bachok, Kelantan as the respondent to obtain folklore. This study uses the application of *Kahoot* to study the perceptions in University Malaysia students. The researcher took a total of 38 students in University Malaysia Kelantan ranging in age from 21 to 23 years old. The respondents consisted of 30 female students and 8 male students.

Data Analysis

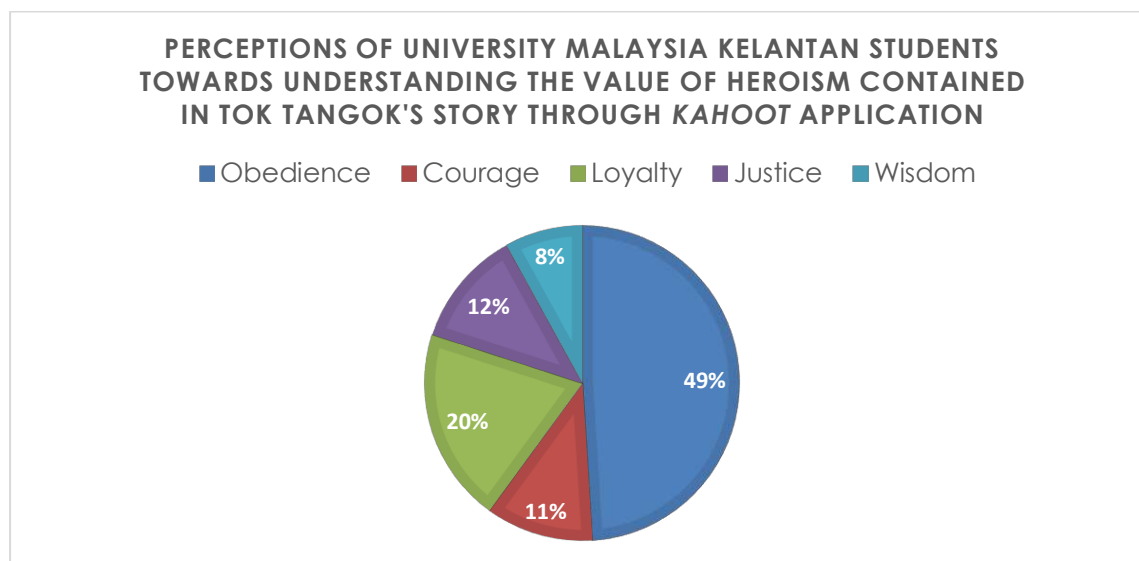

This study found that 49% of students were able to identify the value of heroism through the aspect of obedience compared to wisdom, which is only 8%. This proves through the *Kahoot* application, students better understand the value of obedience in the story of *Tok Tangok*. Students are also able to identify the value of loyalty that is, as much as 20%. This is said so because the *Kahoot* application is able to provide knowledge through the appreciation and understanding of *Tok Tangok* folklore passages to students. The next aspect is justice which has a percentage of 12%. Students are able to understand the context of justice through the *Kahoot* application. In addition, this study found that there is a value of courage of 11%. Through this *Kahoot* application, students are able to distinguish fractions in the value of heroism through the story of *Tok Tangok*. Therefore, the use *Kahoot* able to mobilize students' thinking to unearth the behavior of a folklore hero in Malay.

Conclusion

As a result, this study focuses on the perceptions of students from University Malaysia Kelantan on the values of heroism in the folklore entitled *Tok Tangok* through the application of *Kahoot*. Therefore, based on the analysis data of the study obtained, then this study proved to show that *Kahoot* application gives interest and fun to students to read folklore.

References

- Dundes, A. (1965). *The Story of Folklore*. Englewood Cliffs, N.J: Prentice-Hall.
- Halimah Hassan. (1989). Masyarakat dalam Sastera Rakyat. *Dewan Sastera*. 8: 47-48.
- Muhammad Nur Al-Hakim Mohamad Hanafiah & Mohd Firdaus Che Yaacob. (2020). Nilai-nilai Islam dan Pembentukan Akhlak dalam Cerita Rakyat Melayu. *International Journal of Language Education and Applied Linguistics (IJLEAL)*. 10 (2), 48-56.
- Muhammad Nur Al-hakim Mohamad Hanafiah* Dan Mohd Firdaus Che Yaacob. (2021). Cerminan Nilai-nilai Islam Dalam Koleksi 366 Cerita Rakyat Malaysia: Satu Pendekatan Takmilah. *Journal of Business and Social Development*. 9 (1), 51-62.
- Noviatin Syarifuddin. (2016). Manifestasi Legenda Kepahlawanan Monsopiad Sebagai Identifi Etnik Kadazandusun: Citra dari kacamata Peribumi Penampang, Sabah. *Malaysian Journal of Society and Space*. 12 (5), 136-147.
- Tuan Siti Nurul Suhadah Tuan Adnan & Mohd Firdaus Che Yaacob. (2020). Akal Budi dalam Naratif Lisan penduduk Kota Bharu, Kelantan: Satu penelitian kemasyarakatan. *PENDETA: Journal of Malay Language, Education and Literature*, 11 (2), 126-140.

LEGENDA PUTERI SAADONG NARRATIVE APPRECIATION THROUGH 2D GAME APPLICATION

Fairuladilan Hamadun

Universiti Malaysia Kelantan, Bachok, Kelantan
fairul.h@umk.edu.my

**Izati Nabila Marzuki, Md Ariff Ariffin, Hidayat Hamid, Suraya Md Nasir,
Farrah Atikah Saari, Daeng Haliza Daeng Jamal, Tan Tse Guan, Anuar Mohd Yusof**

Universiti Malaysia Kelantan, Bachok, Kelantan
nabila.m@umk.edu.my, ariff.a@umk.edu.my, hidayat.h@umk.edu.my,
atikah.s@umk.edu.my, haliza.j@umk.edu.my, tan.tg@umk.edu.my, anuararmy@umk.edu.my

Highlights: *Legenda Puteri Saadong* is one of the well-known epic stories among people in the state of Kelantan. Filled with various element and notion, this folklore needs to be appreciated especially in its narrative aspect. Although numerous efforts have been made to uplift the narrative of *Legenda Puteri Saadong*, there is still a gap of knowledge that needs to be accommodated, particularly through the use of Two-Dimensional (2D) game application. Thus, this paper attempts to fill in the gap by developing a 2D game application based on the narrative of *Legenda Puteri Saadong* through a combination of 5W1H method which is What? Who? Where? When? Why? How? by Rudyard Kipling (1902) and ADDIE, abbreviation for Analysis, Design, Development, Implement, and Evaluate by FSU (1975). Results show that the use of 2D game applications using 5W1H and ADDIE methods significantly contribute to *Legenda Puteri Saadong* narrative appreciation.

Key words: *Application, 2D, 5W1H, ADDIE, Legenda Puteri Saadong*

Introduction

Legenda Puteri Saadong is one of the well-known epic stories among people in the state of Kelantan. Filled with various element and notion, this folklore needs to be appreciated especially in its narrative aspect. The story is about *Puteri Saadong*, the adopted child of *Che Siti Wan Kembang*. It starts with the sacrifice of *Puteri Saadong* who were betrothed to The King of Siam despite still being a wife to Sultan Abdullah. Despite the efforts to uplift this folklore to the public, there is still a gap of knowledge that needs to be accommodated, especially through 2D gaming application.

Content

Please include as many of the following sections as possible in your paper, as relevant.

1. Description of innovation / product development / design / process.

The creation of 2D Gaming Application based on the narrative of *Legenda Puteri Saadong* is innovative to embrace and promote the folklore towards digital platforms. Product development process starts with the creation of 2D gaming applications using the story as the main mechanism and content. The designs are based on the world of *Legenda Puteri Saadong* with reimagined characters which are considered to be hip and cater to the younger generation. The final product is a mobile based application using Adobe XD. Background, world and characters are the first part to develop. Next, gaming mechanisms will be created and tested.

2. What is the context or background of the innovation / product development / design / process?

This product develop by using 2 conceptual framework which is;

- 5W1H by Rudyard Kipling (1902), example:
 - i. What - What is the main target of Raja Siam?
 - ii. Who - Who is Puteri Saadong?
 - iii. Where - Where is Puteri Saadong hiding with Raja Abdullah when the Raja Siam counter Kota Mahligai?
 - iv. When - When did the epic story of Puteri Saadong happen?
 - v. Why - Why Puteri Saadong killed Sultan Abdullah?
 - vi. How - How Puteri Saadong escaped from the Raja Siam?

- ADDIE Model by FSU (1975)
 - i. Analysis - Narrative analysis the Legend of Puteri Saadong
 - ii. Design - Narrative environment design (time and location background) and character for the Legend of Puteri Saadong into 2D elements based on appropriate facts.
 - iii. Development - Develop game application mechanism, application usability methods.
 - iv. Implement - Combine the elements of narrative and characters of the Legend of Puteri Saadong into the game application.
 - v. Evaluate - Run a test towards the effectiveness of game application.

- 3. Why are they important to education?
 - The Legend of Puteri Saadong is important for moral education towards the younger generation from its richness of good exemplary. The element of 2D Game obviously can attract students to understand the legend of Puteri Saadong easily since the visuals to represent the characters are using the techniques of cartoon design. 2D games for local legends are rarely developed in Malaysia, this innovation will be a new effort in order to invite students and the younger generation to understand their history better.
 - The education today is no longer dependent on books or printed materials as a main reference but the digital content is at the same level of importance. Students nowadays tend to find online information rather than printed information from the library or book shop. It is important for us to create more useful and authentic content online to make sure they are not getting misleading information about our own history and legend.
 - The innovation of local legends through digital platforms will enhance the richness of education materials in Malaysia. The education will be more energized and effective by using the platform of online digital learning. Learning is fun and easy all the time, not only for the students but also helps the teachers, instructors and parents.

- 4. Please write any advantages of your innovation / product development / design / process towards education and community.
 - To introduce the local history towards bigger reach and prospect, in conjunction with The 4th IR
 - Suitable for young generation learning through mobile technology
 - Foster an interest in folklore among the young generation

- 5. Please add any commercial value in terms of marketability or profitability of your innovation / product development / design / process if any.
 - This 2D Game application will be available in Apple AppStore and Google Playstore



Figure 1: Legend Puteri Saadong 2D Game Character



Figure 2: Legenda Puteri Saadong 2D Game Concept



Figure 2: Legenda Puteri Saadong 2D Game Concept

References

- Danver, S. L. (2016). The SAGE Encyclopedia of Online Education. United Kingdom: SAGE Publications.
- ISFET. (2021). What is the ADDIE Model? Retrieved from International Society for Educational Technology: <https://www.isfet.org/pages/addie-model>
- Markov, S. (2019, March 19). The Kipling method (5W1H). Retrieved from Genvive: <https://geniusrevive.com/en/the-kipling-method-5w1h/>
- Nath, S. (2021). Quality Circle Mantras - Success through Teamwork. India: Walnut Publication.

VIRTUAL HERITAGE TOUR THROUGH AUGMENTED REALITY (AR): APPLICATION ON MUSEUMS IN KOTA BHARU, KELANTAN

Daeng Haliza Daeng Jamal

Department of Heritage Studies, Faculty of Creative Technology & Heritage, Universiti Malaysia Kelantan, 16300
Bachok, Kelantan, Malaysia.
haliza.j@umk.edu.my

Norazlinda Mohamed Rosdi¹, Izati Nabila Marzuki¹, Fairuladlan Hamdun¹, Hazrina Hasbolah²

¹Department of Creative Technology and Design, Faculty of Creative Technology & Heritage, Universiti Malaysia
Kelantan, 16300 Bachok, Kelantan, Malaysia.

²Faculty of Entrepreneurship and Business, Universiti Malaysia Kelantan, 16100 Kota Bharu Kelantan, Malaysia.
nabila.m@umk.edu.my, fairul.h@umk.edu.my, hazrina.h@umk.edu.my

Highlights: Cultural tourism contributes almost 40% of profits to the worldwide tourism sector in which museums have become one of the main focuses to world heritage sites (UNESCO, 2020). Based on these factors, the museum is an influential institution to display our cultural products and potentially attract tourists. Along with the evolution of the museum institution, now the museum is a non-formal educational institution and as a place to spread manifestations and present our culture and heritage. Nonetheless, due to the current issues of the Corona Virus (COVID19) pandemic that hit the world in 2019 constrained the presence of visitors to museums. Thus, the Augmented Reality (AR) application seen provide a new form and alternatives to recent era visits that might influence the attention and interest of the community, especially the younger generation nowadays.

Keywords: *Museum, cultural heritage, cultural heritage zone, Kota Bharu and heritage tourism.*

Introduction

Museums are frequently associated with permanent institutions that aim to educate and make public awareness regarding the importance of protecting the nation's cultural heritage. This phenomenon is in line with the museum's function as a building that highlights significant culture and artifacts in a nation's art, science, and culture (Ab. Samad et al. 2012). In general, the principle existence of a museum institution was on several other significant vital requirements such as studying, conserving, preserving, exhibiting and storing artifacts or collections of a country's national heritage, and one of the factors of attraction towards the tourism sector. Hence, museums obtained have the immense potential to attract tourists seeking information on the history, heritage, and culture of a particular community that seems essential in the heritage tourism sector in Kelantan, especially Kota Bharu. Despite this, museum institutions continue to expand worldwide, including in Malaysia, extended to several groups such as federal museums, statutory bodies, private bodies, government, and state institutions.

In Kelantan, most of the museums are located in the Cultural Heritage Zone, Kota Bharu. Among them are the Kelantan State Museum, Handicraft Museum, Islamic Museum, Kelantan Art Gallery, Museum of Adat Istiadat (Istana Jahar), Royal Museum (Istana Batu) and War Museum (Bank Kerapu) as summarised in Table 1. Nevertheless, due to current issues such as the coronavirus pandemic that hit the world in 2019 (COVID19) constrained the presence of visitors to museums as well as impacting the tourism sector and museum institutions in general. This situation also has implications for the heritage tourism sector, especially the Visit Kelantan Year celebration event in 2020.

With this regard, museum institutions need to move parallel towards the development of the digital era in ensuring its sustainability. Therefore, the Augmented Reality (AR) application potentially helps heritage tourism explore the alternatives of new tours platforms that might attract the attention and interest of the community, especially the younger generation nowadays in exploring heritage sites, including museums in the Cultural Heritage Zone, Kota Bharu, Kelantan. As considered the world's fastest-growing economy, the tourism sector, including in Kota Bharu, also seems struggled to survive in the era of the COVID-19 pandemic. Museums in the cultural heritage zone of Kota Bharu, Kelantan have operated their premises to visitors immediately after the Movement Control Order (PKP) 1.0 ended provided with the new norms practices and recorded quite a massive number of visitors. As a result, it shows that the heritage tourism sector in Kelantan, especially Kota Bharu is still relevant in this age of modernization. Hence, a new form of visiting seems to have to implement to secure the heritage tourism sector in the current situation of COVID-19 crisis.

Content

Tourism of Kelantan, especially in Kota Bharu, also dealing with such an impact where visitors are no longer visiting its hot spots, including their heritage sites. Consequently, this situation has significantly affected the number of visitors and further threaten heritage tourism in Kelantan. With this regard, the research has two objectives: empowering cultural heritage through a virtual tour of museums in Kota Bharu, Kelantan, and promoting heritage tourism in the cultural heritage zone, Kota Bharu, Kelantan. Therefore, this research might give advantages of exploring lessons and visualize the 2D contents to enhance the online tour experience, and AR apps create a sense of fun, a preoccupation that can give the audience as if to participate in a comprehensive and realistic tour experience. This research marketability to promote museum institutions, especially in cultural heritage zone, Kota Bharu, Kelantan for the needs of Kelantan Tourism Information Centre (KTIC) and to empower & provide an alternative tour through a digital form for museum institutions in Kelantan whilst sustaining the cultural heritage. Consequently, this research will assist museum authorities in Kelantan in developing a virtual tour museums platform on their website. It also helps cultivate interest & loves in our society, especially among youngsters, to enhance their understanding and appreciation of our cultural heritage and provide a virtual concept of tourism for foreign tourists in exploring our museums.

Table 1: Types of Museums at the Cultural Heritage Zone, Kota Bharu

Built Heritage & Year	Location	Current function
Bank Kerapu (1912)	Jalan Pejabat Pos Lama, Kota Bharu	Kelantan War Museum
Muzium Negeri (1948)	Jalan Hospital, Kota Bharu	<i>Kelantan State Museum</i>
Istana Batu (1939)	Jalan Tengku Puteri, Kota Bharu	<i>Kelantan Royal Museum</i>
Muzium Islam (1902)	Jalan Masjid, Kota Bharu	<i>Kelantan Islamic Museum</i>
Istana Jahar (1887)	Jalan Sultan, Kota Bharu	<i>Muzium Adat Istiadat</i>

References

- Ab. Samad Kechot, Shahidi A. Hamid, Rahim Aman, Zuraidah Hassan & Daeng Haliza Daeng Jamal. (2012). Pendidikan warisan di muzium: Kajian berkaitan penggunaan laras bahasanya. *Geografia Online*, 8(8), 35-46.
- Perbadanan Muzium Negeri Kelantan. Mesyuarat Jawatankuasa Kecil Pewartaan Bangunan, Monumen dan Tapak Tanah Bersejarah, Kota Bharu, Kelantan, 2001.
- UNESCO (2020) Museums Around The World In The Face Of COVID-19, United Nations Educational, Scientific and Cultural Organization (UNESCO) 7, place de Fontenoy,75352 Paris 07 SP, France

AUGMENTED REALITY (AR) NATION'S PILLARS STREET ART IN KOTA BHARU FOR URBAN REGENERATION AND TOURISM

Tengku Fauzan Tengku Anuar

Faculty of Creative Technology and Heritage, Universiti Malaysia Kelantan, Kelantan, Malaysia
Institute for Poverty Research and Management (InsPeK), Universiti Malaysia Kelantan, Kelantan, Malaysia
tengkufauzan@umk.edu.my

**Hani Izzaty Mohd Jamil¹, Wan Ahmad Amir Zal Wan Ismail², Suraya Md Nasir³, Haris Abadi Abdul
Rahim¹, Nawwal Abdul Kadir¹, Nur Athmar Hashim¹, Izati Nabila Marzuki¹, Md Ariff Ariffin¹, Siti Aisyah
Muhammad¹**

¹Faculty of Creative Technology and Heritage, Universiti Malaysia Kelantan, Kelantan, Malaysia

²Faculty of Language Studies and Human Development, Universiti Malaysia Kelantan, Kelantan, Malaysia
Institute for Poverty Research and Management (InsPeK), Universiti Malaysia Kelantan, Kelantan, Malaysia

³Faculty of Art, Computing and Creative Industry, Universiti Pendidikan Sultan Idris, Tanjung Malim, Perak, Malaysia
c18d027f.hani@siswa.umk.edu.my, waamirzal@umk.edu.my, suraya.mn@fskik.upsi.edu.my, harisabadi@umk.edu.my,
nawwal@umk.edu.my, athmar.h@umk.edu.my, nabila.m@umk.edu.my, ariff.a@umk.edu.my, aisyah@umk.edu.my

Highlights: Ann Markusen and Anne Gadwa argued that street art or public art projects could revitalise urban environments, especially in abandoned places and alleys. This method has been adopted in Malaysia as a viable alternative to revitalise abandoned places through creative placemaking. Thus, the purpose of this project is to explore the use of Augmented Reality (AR) in street art projects, specifically in Kota Bharu, Kelantan, and their role in urban regeneration and creative placemaking. It highlights the impact of creative placemaking on urban regeneration and explains how creative placemaking projects can be enhanced using technologies such as Augmented Reality (AR). The study consisted of a quantitative methodology in which data were collected from a series of questions intended for users to experience Augmented Reality (AR) in street art and determining the role of urban regeneration and tourism. The analysis results indicate that implementing Augmented Reality (AR) technology in creative placemaking projects for urban regeneration boosts economic growth rates through their impact on local creative industries and tourism.

Keywords: *Street Art; Mural Art; Augmented Reality; Creative Placemaking; Urban Regeneration*

Introduction

The use of street art as part of creative placemaking projects has been applied to various countries and has helped revitalise urban environments and the surrounding areas (Fun, 2017; Mohd Fabian, Osman, & Mohd Nasir, 2012; Omar, Sakip, & Akhir, 2016). Markusen and Gadwa (2010) explained that creative placemaking has a notable impact on urban places. It rejuvenates structures and streetscapes, boosts local economies, encourages social engagement within communities, and promotes cultural diversity. It also encourages community engagement by creating events focused on arts, culture, and education to preserve and promote artistic and cultural resources (Gomez, 2019).

Art indeed plays a crucial role in creative placemaking by creating a vibrant and considerably more secure environment in the city. One of the more noticeable contributions is boosting economic growth rates through their impact on local creative industries and tourism. There is room for further improvement in these activities. The tourism sectors should encourage local communities to be a part of the tourism industry by contributing to newly formed growth centres and entrepreneurship within local communities (Sharif & Lonik, 2018). Thus, using interactive technology such as AR will help improve local content and enhance the current understanding of the importance of street art projects in creative placemaking as a tool for urban tourism and urban regeneration.

Content

1. Description of innovation / product development / design / process.

These are screenshots of the interface in the application used to scan images (figure 1). Users must download the Nation's Pillars AR app before scanning the following images (figure 2). The scanned images will then present the AR images of the mural. For example, when scanned the 1st image, an AR video of the 1st pillar of the Nation's Pillars, "Believe in God" (*Kepercayaan kepada Tuhan*), will pop up.



Figure 1 Screenshots of AR application UI loading



Figure 2 Series of images for users to scan

- Context or background of the innovation/product development/design/process.

The AR application is called 'Nation's Pillars' and developed for a street art project in Kota Bharu, Kelantan. Several phases conducted in developing this app, including brainstorming session, design and development, application testing, and application publishing. Its design concept is modern with minimal UI design to make sure it's easy to use to open and use the app easily. It used simple architecture where the users would need to download the app in Google Playstore/Apple Appstore, and it will automatically download the content (figure 3). All they have to do is scan the images using their gadgets, and the AR content will play and focus on letting its users experience the Nation's Pillars virtually.

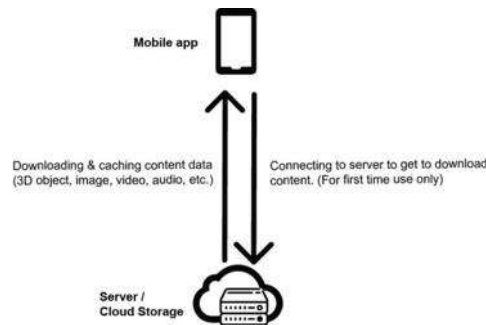

Figure 3 Mobile app architecture

- The importance of education.

The project can help promote and preserve cultural contents through art and education. The use of interactive technology such as AR has increased the number of interactions and enhanced engagement between users, raising environmental awareness. Considering that the numbers of study or projects on AR technology in Malaysia are still a few, it is strongly suggested that local government, researchers, local artists or organisations, and the public consider exploring the use of AR technology in creative placemaking projects in urban areas as an urban regeneration tool.

- Advantages of the innovation/product development/design/process towards education and community.

AR can be used in further advancing creative placemaking projects as well as highlighting the use of culture content such as the Nation's Pillars or *Rukun Negara*, which can help to create a sense of belonging and engagement within society, and also emphasising the importance of implementing *Rukun Negara* as a way of life (figure 4). This AR for street art can be developed and utilised in the tourism field. Given that tourism has always been Malaysia's leading source of income, implementing interactive technologies such as AR could boost

economies. Considering the recent pandemic outbreak of COVID-19, which has severely impacted the tourism industry, it has become essential.



Figure 4 Nation's Pillars Street Art in Kota Bharu, Kelantan

- Commercial value in terms of marketability or profitability of your innovation / product development / design / process, if any.

There are several commercialisation potentials, both in academic and industry. Potential in Academic is AR could help further enhancing creative placemaking projects and urban regeneration, especially during MCO. AR not only helps to promote cultural content but also has educational value. The project's potential is the project was developed according to the government's blueprint in Shared Prosperity Vision 2030, under Key Economic Growth Activity (KEGA) 4, the Content Industries, which focuses on animation, programming, entertainment, and culture Digitalisation. The potential of using AR as an educational application implemented in the tourism industry are high considering the current pandemic. A poster on using the augmented reality application was also designed to help illustrate better (figure 5).



Figure 5 Poster on How to Use Nation's Pillars AR application

Acknowledgement

The authors wish to thank the Ministry of Education Malaysia and the Research, Innovation & Commercialization Center (RMIC), University Malaysia Kelantan (UMK) for supporting this research project under the Fundamental Research Grants Scheme (FRGS) - Ref: FRGS/A0200/00373A/002/2019/00664. We also would like to express our gratitude to several individuals who have contributed their knowledge, time and effort towards making this research a success. Thank you for your valuable time and cooperation.

References

- Fun, C. S. (2017). Street Art Sparkle as a New Economic Driver in Penang. *Malaysian Journal of Creative Media, Design and Technology*, Vol. 1 (No.1).
- Gomez, E. S. (2019). *Augmented Reality and Placemaking: A Theoretical Exploration*. (Bachelor of Science in City and Regional Planning), California Polytechnic State University, San Luis Obispo.
- Markusen, A., & Gadwa, A. (2010). Creative Placemaking. *White paper for The Mayors' Institute on City Design, a leadership initiative of the National Endowment for the Arts in partnership with the United States Conference of Mayors and American Architectural Foundation*.
- Mohd Fabian, H., Osman, M. T., & Mohd Nasir, B. (2012). Towards Integrating Public Art in Malaysian Urban Landscape. *Pertanika Journals Social Sciences & Humanities*, 20(2), 251 - 263.
- Omar, S. S., Sakip, D. S. R. M., & Akhir, N. M. (2016). Bringing The New To The Old: Urban Regeneration Through Public Arts. *Procedia - Social and Behavioral Sciences* 234 (2016) 515 – 524.
- Sharif, N. M., & Lonik, K. A. T. (2018). PENGLIBATAN KOMUNITI TEMPATAN DALAM KEUSAHAWANAN PELANCONGAN: KAJIAN KES PULAU PERHENTIAN, MALAYSIA [ENGAGEMENT OF LOCAL COMMUNITY IN TOURISM ENTREPRENEURSHIP: A CASE STUDY OF PERHENTIAN ISLAND, MALAYSIA]. *Journal of Nusantara Studies* 2018, 3(1), 103-119.

IMPROVING THE USER INTERACTION THROUGH BAMBOOSA VOID PAVILION AT HOSPITAL PASIR MAS, KELATAN

Zulhilmi Zahari

Faculty of Architecture and Ekistics, University Malaysia Kelantan,
Bachok Campus, 16300, Bachok, Kelantan, Malaysia
zulhilmiz563@gmail.com

Wan Azlina Wan Ismail, Ramly Hasan, Nurul Izzati Othman, Nor Hamizah Abdul Hamid

Faculty of Architecture and Ekistics, University Malaysia Kelantan,
Bachok Campus, 16300, Bachok, Kelantan
azlina@umk.edu.my, ramly.h@umk.edu.my, izzati.o@umk.edu.my, norhamizah@umk.edu.my

Highlights: Open spaces within a hospital area could encourage social interaction between its communities essentially the patients, healthcare workers and visitors. Staying and working in the hospital for a long time will affect the emotional state of a person, well-being, and healing time. However, the hospital building, and its surrounding area might enhance the negative feelings or, conversely, produce feelings of confidence and hope for the recovery processes. Therefore, the innovation of Bamboosa Void Pavilion intentionally maximizes the healing functions of the therapeutic landscape and increase the aesthetic value of the hospital whilst improve the social connection and develop reflective thinking capabilities within the healthcare community.

Key words: *Pavilion, bamboo, hospital, social, interaction, patients, visitor*

Introduction

Bamboosa Void is a new iconic structure in the Hospital Pasir Mas and becomes a main focal point for social and interaction purposes. Staff, patients and also visitor can access this area and experience the natural ambience in the bamboo plaza with the therapeutic landscape design. The local can bring their stuff, interact and communicate with each other at the pavilion that will establish strong sense of community. The idea is to recelibrate and restore the image of therapeutic in Hospital Pasir Mas. The material is inspired by some existing structure that used bamboo as the main material. Bamboo, as one of the most important components of current regenerative green construction material, is getting more and more designer favours on its performance. The bamboo membrane system as one that has both practicality and aesthetic, the performance of adaptability and multipurpose will make it could be used in the public area as social point Centre. The design will highlight some features that make this designed pavilion look more aesthetic and natural effect despite serving as the interaction point in the Hospital Pasir Mas. The form of the leaves is formed from the basic two curvy lines that combine to become the shape of a leaf. (Figure 5.2) The leaf shapes symbolize the therapeutic as they bring the image of nature. Also by using bamboo as the material give a more natural effect toward the structure.

Besides that, the Bamboosa Void Pavilion have three design principle applied to the innovation that are natural ventilation, natural water run-off and shaded area. In term of the material used, this designed pavilion use bamboo as the main construction material, solar panel and polycarbonate as the roofing. In general, bamboo material can provide low-carbon alternatives to several materials, including steel, cement and plastic thus promote the use of green design and also cost-efficient in term of aesthetic value impact. Furthermore, bamboo also has high Flexibility and elastically. Besides it is easy to get the material as well as it is easy to grow up the bamboo and easy to be recycled. Fire and heat resistance also become one of the reasons why this material takes part in this pavilion construction. For the dimension of this Bamboosa Void Pavilion. Overall height is about 5600mm, and the length is about 28000mm as shown in (figure 5.8). The use of the solar panel in this pavilion is purposely for the lighting during night and at the same time promoting sustainable approaches. The solar panel trap the sunlight and convert it to the electrical source to light up the sport light. For the roofing, the material used is polycarbonate PVC type. Toughness, transparency, heat and flame resistance, and dimensional stability are all characteristics of polycarbonates. It's a high-performance plastic sheet that's a direct competitor on the market right now. Combining strength, impact resistance, and high transmission across 200 times the thickness of glass. Despite this material allow the light to penetrate and reach for the vertical planting at the structures.

This innovation not only provides aesthetic impact but also give advantages to some communities related. Patients and visitor can use this pavilion as an area to socialize with family and the waiting area around the Hospital despite embrace the uniqueness of the Bamboosa Void. The location located area very strategic as facing up to the Furqan plaza that has a mosque with water features will maximize the experience for the user. For staff, stress, pressure, hectic environment is common to experience by the staff working in the hospital. So they can come and release their stress at the plaza experiencing the Bamboosa Void Pavilion that gives a visual impact for the user. Government policies can increase the incentives to innovate, including guaranteeing intellectual property rights, government assistance with the costs of research and development, and cooperative research. Besides that, local authorities or government can use it as a guideline to be implemented at suitable spaces such as a park, institution, etc.

This innovation promotes the uniqueness of this Bamboosa Void through social media as that is the easiest platform nowadays. The user just needs to scan and view the page to see the content and some information regarding the Bamboosa Void including the views, construction and others. At the same time we can collaborate with the local authorities to set as a new guide for the designing public spaces in Hospital.

Acknowledgement

Special thank and gratitude for my studio lecturers, LAr. Dr Ramly bin Hasan, Dr Wan Azlina Wan Ismail, Dr. Nur Hafizah binti Ramle for guiding me to complete my innovation project to be successful.

References

- Aelbrecht, Patricia. (2016). 'Fourth places': the Contemporary Public Settings for Informal Social Interaction among Strangers.. *Journal of Urban Design*. 21. 1-29.
- Pacione, M. (2003). Urban Environmental Quality and Human Well-being -A Social Geographical Perspective. *Landscape and Urban Planning*. 65, 19-30.
- Rasidi, M. H., Jamirsah, N., and Said, I. (2012). Urban Green Space Design Affects Urban Residents' Social Interaction. *Procedia - Social and Behavioural Sciences*, 68, 464-480
- Salwa, Sharifah & Syed Mahdzar, Sharifah Salwa & Sham, Rashidah. (2018). Third Place through Orchid Pavilion as Social Node for Kampong Bharu Neighborhood.

AN ENVIRONMENTAL ADAPTIVE DESIGN OF THE ECLECTIC SET

Lai Man Fai

Faculty of Architecture and Ekistics, University Malaysia Kelantan,
Bachok Campus, 16300, Bachok, Kelantan.
lmfai.g17a0024@siswa.umk.edu.my

Wan Azlina Wan Imail, Ramly Hasan, Nor Hamizah Abdul Hamid, Yeo Lee Bak, Nor Diana Aziz

Faculty of Architecture and Ekistics, University Malaysia Kelantan,
Bachok Campus, 16300, Bachok, Kelantan
azlina@umk.edu.my, ramly.h@umk.edu.my, norhamizah@umk.edu.my, yeoleebak@umk.edu.my,
dianaaziz@uitm.edu.my

Highlights: Malaysia, like many other developing countries where building conservation continues to be a recent trend, facing some challenges with their historical building. A place characteristic and identity influenced by its tangible and intangible aspects of cultural and heritage resources becomes vital. An adaptive environmental design of street furniture named The Eclectic Set for Tronoh Town was created to reinstate the early tin mining industrial history and its unique living environment. The innovation of this street furniture is based on the genius loci of Tronoh Town including its building characteristics, the community living culture, planting typology, and climatic factors.

Keywords: *Building Conservation, Cultural Heritage, Environmental Adaptive Design, Street Furniture, Historical Landscape Design*

Introduction

Street furniture is a combined term used for features placed on streets for variety intentions. It incorporates seats, traffic barriers, traffic signs, telephone boxes, post boxes, bollards, traffic lights, street lamps, car stops, taxi stands, open restrooms, sculptures etc. Street furnishings give vital comforts to people on foot by adding usefulness and imperativeness to the person on foot placement. They declare that people on foot are welcome and that the road is becoming a pleasant spot to be. These pleasantries give a helpful service to the person on foot and give visual detail and intrigue. Cultural heritage is often correlated with artefacts derived from previous cultural practices and may include natural and human-made elements. (Canizaro, 2007; Raj Isar, 2004). There are two types of heritage: tangible heritage and intangible heritage. The selected site, Tronoh, will show how the street furniture can form an adaptive environment design that blends into the cultural heritage of the Town, which are the strait eclectic style pre-war shophouses and its strong Chinese identity.

My innovative street furniture named The Eclectic Set combines a planter box, 2-person seat slot, up-down holder. The design challenge is how to create a brand-new design without any conflict with the facade of heritage shophouses and the living style of the residents. Before I proceed to the design phase, I have a site inventory and analysis to collect the data needed at the Town, including demographic data, climate factor, building's characteristics, street view, vegetation, etc. The questionnaire and interview methodology are helping me proceed into the next phase, which is the product of the design idea. The design I finalize emphasizes the method to implement the pattern and structure of different building's components into the street furniture.

Based on the components of the Eclectic Set, we can picture the street furniture designed according to the Town's physical structure, which is the heritage shophouses. The heritage shophouses can be defined into four components: the wooden folding window, iron bar window, galvanized iron folding door, and concrete/plaster pillars. There are many unique textures and patterns with the art deco style and strait eclectic style with the colour scheme of white, grey, pale blue, beige is implemented into the design of planter box and bench's support base. The backrest of the bench is formed by a curvy design for comfortable usage. The main materials of the furniture are balau timber, galvanized steel, and concrete. The seat part is made of balau timber representing the wooden material of buildings, and the identity of Chinese believes life connects nature with people. Concrete is used as the primary material of the furniture to form the adaptive climate design. Last, the galvanized steel is referred to as the iron bar window, and folding door implement.

The Eclectic Set is designed as one solution to face the Town's critical condition: the history and culture are forgetting and lost among the people. The Eclectic Set is providing an opportunity for youth and the elders to bring back their memory about the story of Tronoh town. Thus, it also involves a significant step in town rejuvenation to achieve the objectives to enhance the streetscape and raise the awareness of residents and outsiders to the town's importance. As a town with many institutions, including primary and secondary school, it will provide a good education opportunity to teach the students or youth to appreciate ancestors' contribution. On the other hand, they can also learn to recognize the heritage shophouses and components as the Town's treasure.

Furthermore, the Eclectic Set with unique design will become one of the popular instagrammable spots in the Town that can attract many foreign visitors who are getting news from social media or the latest news. The active tourism activity will provide a huge economic booster for residents to conserve and preserve the Town's cultural heritage. The commercial cycle will form a stronger bond and place attachment that will guide the residents to have a high awareness of the Town's preservation and conservation of cultural heritage.

Figure 1 show the 3D model and material of the the Eclectic Set.

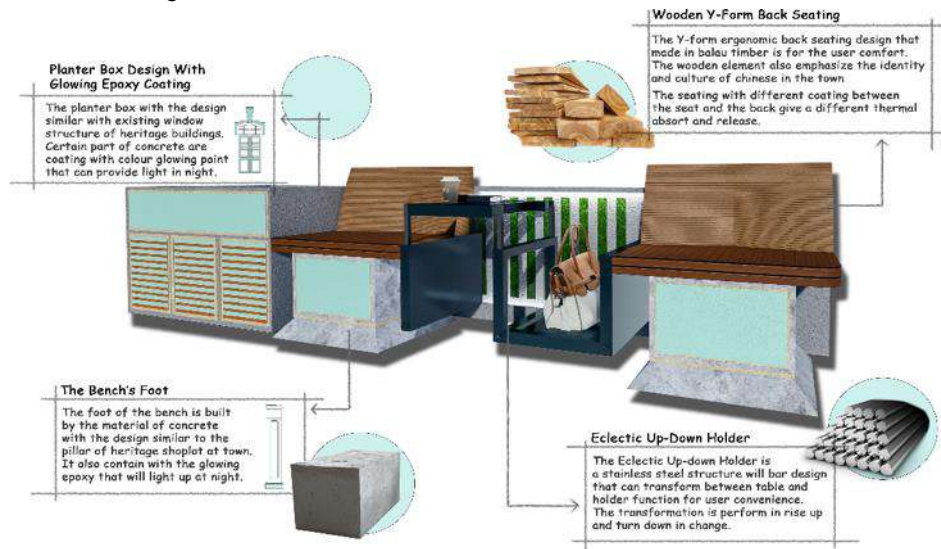

Acknowledgement

I would like to express my gratitude to the guidance of my lecturer, LAr, Dr Ramly bin Hasan and Dr. Wan Azlina Wan Ismail for their patience and proper guidance to achieve this innovative design project. Here I also want to give special thanks to my friends and coursemates for helping me pull out this creative idea.

References

- A. Bahita, "Placemaking - creating a sense of place and place of sense", Research paper, MBS school of Planning and Architecture, New Delhi, India, 2015. [Online].
- "Benches and Seating", *SF Better Streets*, 2011. [Online]. Available: <http://www.sfbetterstreets.org/findproject-types/streetscape-elements/street-furniture-overview/benches-and-seating/>.

SPACE SAVING AND SUSTAINABLE FOR CYCLIST BY COMBINATION DESIGN AS CYCLIST FRIENDLY BENCH AT SUNGAI LEMBING, KUANTAN, PAHANG

Lee Pui Yin

Faculty of Architecture and Ekistics, University Malaysia Kelantan,
Bachok Campus, 16300, Bachok, Kelantan.
lpyeon0520@gmail.com

Wan Azlina Wan Ismail, Ramly Hasan, Nor Diana Aziz, Nor Hamizah Abdul Hamid, Nurul Izzati Othmani

Faculty of Architecture and Ekistics, University Malaysia Kelantan,
Bachok Campus, 16300, Bachok, Kelantan
azlina@umk.edu.my, ramly.h@umk.edu.my, dianaaziz@uitm.edu.my, norhamizah@umk.edu.my,
izzati.o@umk.edu.my

Highlights: Bicycle is an old traditional transportation in past of Sungai Lembing. Until now, cycling is still one of important transport and activity for local villagers and also cyclist lovers who visit Sungai Lembing by cycling from another places such as Kuantan. Although cycling is important in Sungai Lembing, but the facilities for cycling such as parking space are lacked, which caused cyclists have no idea to ensure their bicycle in safety. Cyclist Friendly Bench is created and proposed for cyclist in Sungai Lembing by combination of round wooden bench and cycling parking. The design created a resting spot for users, in the same time, created cycling parking with reduce spaces to propose another parking space.

Key words: cyclist, user friendly, innovation, local traditional, cultural heritage, transportation

Introduction

The design of Cyclist Friendly Bench is used to as a unique design by combination of 2 uses which are usually used and important in the site, such as local own traditional transportation, bicycle, and also the needs of tourists, resting spot. With these 2 needs by 2 main users in Sungai Lembing, the combination may bring the opportunity of interaction of local people with tourists, since the tourists also as important customers for local people as their main economic incomes. Bicycle Friendly Bench mostly located at the historical commercial shop-houses area in Sungai Lembing. It encourages the cyclists to easy to rest their bicycle safely and visit inside the shop houses. The bench is proposed under the existing big shade tree which provided nature low sun exposure resting spot.

The advantages of Cyclist Friendly Bench are space saving which reduce the space need by combine 2 functions into one element, create gathering spot by attracting both functions' users in one space, and eco-friendly materials which used by wood and stainless steel as main materials for the design. For the advantages to local people, the space saving created by the combination of both bicycle parking facility with round design bench for reducing space and easier use for users. Main materials used are mainly in Cengal wood for bench seat which have water proof function and also create nature sense to merge traditional old style in Sungai Lembing. Bicycle rack and bench support used in stainless steel to ensure the endurance and hardness for protection. For tourists' advantage, the bench design helps to create a gathering sense especially for cyclists for resting in the same time it also formed a node in the space. With these advantages, Cyclist Friendly Bench will create a strong local image and lifestyle in Sungai Lembing.



Figure 1.0: Design of Cyclist Friendly Bench

Acknowledgement

I would like to express my thanks of gratitude to my lecturers, Dr Ramly bin Hasan, who gave me the golden opportunity to do this wonderful project, for the invaluable advice, continuous support, and patience during the innovation project. I am also overwhelmed in all humbleness and gratefulness to acknowledge my depth to all those who have helped me to put these ideas, well above the level of simplicity and into something concrete.

References

Savannah College of Art and Design (2011), Bench Rack: Multi-use Bike Rack Design of Dupont Corian Elena, S. (2016). Designing High Density Urban Bike Parking. Proposal: 'BRB-Bike Rack/ Bench'

THE CONNECTEDNESS BETWEEN SPACES TO STIMULATE THE LIVEABLE ENVIRONMENT BY THE PLEXUS IN JOHOR BAHRU CITY CENTRE, JOHOR

Nur Rabihtul Samsudin

Faculty of Architecture and Ekistics, Universiti Malaysia Kelantan,
Bachok Campus, 16300 Bachok, Kelantan, Malaysia
rabihtulsam@gmail.com

Wan Azlina Wan Ismail, Ramly Hasan, Noorliyana Ramlee, Yeo Lee Bak, Nor Diana Aziz

Faculty of Architecture and Ekistics, Universiti Malaysia Kelantan,
Bachok Campus, 16300 Bachok, Kelantan, Malaysia
azlina@umk.edu.my , ramly.h@umk.edu.my , liyana.r@umk.edu.my , yeoleebak@umk.edu.my
, dianaaziz@uitm.edu.my

Highlights: Cities are often associated with congestion both in terms of the number of vehicles and visitors which play an important role in ensuring that the infrastructure functions in the city are applied. The idea of innovating The Plexus was sparked to solve that factor as well as simplify life in the city. The unique design also plays an important role in producing the best visual effect as a result of the concept of the plexus as one of the important functions that needs to be highlighted.

Key words: *urban city, design innovation, solar, universal design, connectivity, wayfinding*

Introduction

Johor bahrु city is famous for its busy streets as well as being a focal point for tourists. Not only that, the growing neighborhood here also plays an important role in the development in this area. Connectivity in a city is very important to create interconnectedness with each other. With the busy city atmosphere, sometimes there are various accidents that occur especially on the main road. Therefore, with the presence of The Plexus, consumer safety can be improved in addition to being able to connect the area here and become one of the symbols of pride in this area of the city of Johor Bahrु. The attractive design and symbolizes the identity of the state of Johor can be one of the landmarks to this area.

The Plexus has been studied for its nature which is just as important as in the human body, so it is also important in a city. The study was made by analyzing the main areas in the city and then plotting the strategic position of The Plexus to be located. As is well known, urban life is quite busy and requires a high -end telecommunication system to keep consumers in touch no matter where they are. Apart from increasing connectivity in this area, The Plexus is also able to provide solar charger services for users who need it. To ensure that various sections of society can use this innovation, universal design has been implemented with no use of stairs on this bridge. The road will continue to the destination area safely and comfortably. In addition, the pattern on the floor of the bridge displays the direction of travel for users to know where they are going more effectively. This way, users will easily get info about the position of where they want to go in the city.

The benefits that can be highlighted from this design are divided into two, namely the community and the capabilities in this area. For the community, it can facilitate travel to the desired area, increase safety, save time and be a signpost for those who have just come to the city. While the advantage for this area, it is able to be a sense of welcoming, sense of direction and sense of belonging in this area. With its attractive and luminous design at night, it will definitely be one of the landmarks here by containing lighting that uses blue and red lights to symbolize the identity of the state of Johor. it can thus create a sense of identity to users around the area.

Acknowledgement

I would like to express my thanks of gratitude to my fellow lecturers, Dr Ramly bin Hassan and Dr Wan Azlina binti Wan Ismail, who give me the golden opportunity to do this project and has given me a lot of ideas and very helpful her student incompleting the project tasks has given that required to be done. I am also over helmed in all humbleness and gratefulness to acknowledge my depth to all those who have helped me to put these ideas, well above the level of simplicity and into something concrete.

References

- Interaction between Road Network Connectivity and Spatial Pattern. (2016, January 1). ScienceDirect
<https://www.sciencedirect.com/science/article/pii/S2212017316301025>
- Kareem, Buyana, et al. "Urban Connectivity Is a Catalyst for Leaving No One Behind," The Nature of Cities, 9 Dec. 2017,
<https://www.thenatureofcities.com/2017/12/09/urban-connectivity-catalyst-leaving-no-one-behind/#:~:text=There%20are%20two%20broad%20categories,sanitation%2C%20water%2C%20etc.>)

BUBU ARCHWAY

Syamimi Mohd Noor

Universiti Malaysia Kelantan, Campus Bachok, 16300 Bachok, Kelantan
mimisya47@gmail.com

Ramly Hasan, Wan Azlina Wan Ismail, Nor Diana Aziz, Mohammed Fadzil Maharimi

Universiti Malaysia Kelantan, Campus Bachok, 16300 Bachok, Kelantan
ramly.h@umk.edu.my, azlina@umk.edu.my, dianaaziz@uitm.edu.my, fadzli.m@umk.edu.my

Highlights: Facilities in a village are very important to provide convenience to the villagers. The facilities provided can provide opportunities for the villagers to generate income. Therefore, this Bubu archway can give guidance and attract the attention of visitors as well as show the identity of this village as a fishing village. In addition, this archway can also increase the aesthetic value of this village as a unique fishing village.

Keywords: Archway, form, traditional, fishing tool, Aesthetics, and unique

Introduction

Bubu Archway is the new iconic entrance to Kampung Punggai and has become the identity of Kampung Punggai as a fishing village. The structure is located in the Jetty area. This archway can be a guide to the jetty area and commercial areas to visitors. The villagers can do business activities and generate income because this archway can attract visitors to come to this area. The idea of this archway was made to make this village a fishing village that is different from other fishing villages and can increase the aesthetic value in Kampung Punggai.

The main material used is bamboo. Bamboo is a more sustainable material because bamboo has a lightweight property that does not require heavy machinery to move it, the nature of bamboo has strong durability, longer-lasting, an aesthetic value that plays an important role, and Construction from bamboo is not only amazing but can make an iconic attraction.

This design has a uniqueness and interesting from the composition of the elements of a traditional fishing gear that is Bubu Ikan. The combination of bamboo and wire elements can show the design of cultural elements in this village. Seabed traps are "mandatory" equipment for fishermen in this village. Using wire, bamboo, and iron as the main materials, trap making, in addition to the skill of embroidering wires and forming valves, is the entrance of fish into the trap.

In addition, Bubu Archway has guidelines to be made in certain areas such as aesthetics, unique, attractive scenery, access roads, and functional areas. Among the materials used is bamboo which is the main material, wire or steel is used to form fish sculptures, and concrete is used to support the archway. This archway trap is made with a size such as with a height of 3000mm and a width of 3500mm. The use of wire or steel to form fish sculptures seems to be in the fish cages used by the villagers. Inspired by the form of 'Bubu Ikan' which is a traditional tool for catching sea fish used in this village. In addition, this archway uses recycled materials from these fishing gear.

Bubu Archway also not only has aesthetic value but can also symbolize the area of Kampung Punggai, which is a central area for collecting fresh seafood and fishermen's settlement area. The Archway serves as the entrance to the Kampung Punggai Jetty which shows the identity of Kampung Punggai. It can also give a sense of friendliness and can attract visitors. The advantage for this design community is that it can attract visitors to commercial areas and the income of the population is increasing. This design can show the identity of the area which is the jetty area and can attract visitors. These arch traps benefit the community to be able to attract visitors to commercial areas and the income of the residents is increasing. This arch trap also benefits visitors can show the identity of the area which is the jetty area and can attract visitors.

This innovation promotes the uniqueness of Bubu Archway through social media because it follows the currents of modernity to find out more about this archway. The website used is a blogger. Users just need to scan and view the page to see the content and some information about Bubu Archway including views, construction, and others.

Acknowledgment

First, I want to thank God for allowing me to participate in this successfully. I thank my supervisor Lar Dr. Ramly Bin Hasan, Dr. Wan Azlina Binti Wan Ismail, and Dr. Nur Hafizah Binti Ramle who gave a lot of guidance to complete this project successfully. Finally, I would like to thank both my parents who have been very supportive of me. Alhamdulillah.

References

- Kumar, V. (2009), "A process for practicing design innovation", Journal of Business Strategy, Vol.30 No. 2/3, pp. 91-100.
Sukumar, N., Bayeleyegn, M. and Aruna, S. (2021), "Development and characterization of epoxy resin composite reinforced with bamboo fiber and bagasse as filler", Research Journal of Textile and Apparel, Vol. ahead-of-print No. ahead-of-print.

THE UNIQUENESS OF BLOSSOM CATCHMENT WATER

Aqilah Azeni

Faculty of Architecture and Ekistics
Universiti Malaysia Kelantan, Bachok, Malaysia
aqilahazeni97@gmail.com

Ramly Hasan, Wan Azlina Wan Ismail, Nor Diana Aziz, Mohd Azri Mohd Jain Noordin

Faculty of Architecture and Ekistics
Universiti Malaysia Kelantan, Bachok, Malaysia
ramlyhasan80@yahoo.com, azlina@umk.edu.my, dianaaziz@uitm.edu.my, azri.mjn@umk.edu.my

Highlights: Due to the people of Bandar Penggaram's busy schedules at work and a lack of leisure and recreational activities, they want a location that is closer to greenery and recreation. Blossom Catchment Water was built to ensure that the tree's freshness could be maintained. As a result, the development of a more sustainable method based on the Water Harvesting System. This strategy can help inhabitants appreciate the recreation space by making it easier for them to sense the panoramic vegetation.

Key words: *Leisure and recreation activities, Water Harvesting System, freshness, Blossom Catchment Water and panoramic vegetation.*

Introduction

Blossom catchment sculpture is located in the rest area for the elderly at the Batu Pahat sports center. This sculpture was born due to my concept of greenery, to ensure the surrounding trees in the garden are healthy, the water source is obtained from the tool. Blossom catchment sculpture is a flower-shaped sculpture that is used as an aesthetic value as a sculpture but is also a tool for harvesting system to recycle rainwater to be used again to watering trees and others.

Blossom catchment rainwater is an innovative product for water harvesting system, the unique design of the flower that collects water is also used as a sculpture as an aesthetic during the day. This product uses thermoplastic polyolefin for flower roof, to easily flow water to the water tank of blossom catchment water, with the use of thermoplastic polyolefin it is durable and avoids from damaged roofs due to water and heat. The water flowing to the water tank will go to the underground main water tank, the water collected will be used as irrigation water for plants and other uses. This way it can reduce the water bill for garden maintenance. The material that use for this product are stainless steel is a aesthetic appeal with is available in many surface finishes. It is easily and simply maintained resulting in a high quality, pleasing appearance. Stainless steel also a durable, low maintenance material and is often the least expensive choice in a life cycle cost comparison. This product come out because I want the residents of the Bandar Penggaram to be able to experience the greenery of the recreation area. Blossom water catchment is used as water storage for plants in the recreation area so that plants can get enough water and can produce a green panorama for user.

This product is very important in producing benefits for the environment, because nowadays young people are less close to the environment, with the recreation park, they can enjoy the greenery even in the city. With the greenery provided can relieve tension and can obtain a well being life. Blossom catchment rainwater can protect the environment by recycling existing rainwater and reusing it for backup water supply and helping to reduce the cost of water bills to be paid. This method can help in the maintenance of local authority and can be given for local community in well-being. Designing and installing rainwater collection systems can provide sustainable jobs for the economy of the future. The rainwater harvesting industry can become a leading employer in the green infrastructure movement. Rainwater from a potable rainwater harvesting system that has been properly filtered and disinfected is some of the best tasting water available. It doesn't have the many chemicals that municipally treated water has such as fluoride or chloramines (chlorine).

People can find out more about this innovative product in social media such as twitter by typing greenspine and can find out more about this product. There is a notice board that shows a bar code that goes directly to the webside about blossom catchment water about advantage and others.



Blossom Catchment Water

Acknowledgement

I'd want to express my gratitude to my lecturers, Dr Ramly Hasan, Dr Wan Azlina, Nor Diana Aziz, and Mohd Azri Mohd Jain Noordin, for letting me know whether there is a flaw in this innovation design and allowing me to develop as a result of their feedback. I'd want to express my gratitude to all of my friends that assisted me in completing this project.

Reference

"Water Harvesting System" E. Landscape, 2013. [Online]. Available: <https://www.e-landscapellc.com/benefits-of-rainwater-harvesting-for-commercial-buildings/>

THE ATTRACTIVE OF NEON TUNNEL DESIGN

Muizzuddin bin Basharudin

University Malaysia Kelantan, Kelantan, Malaysia
muizbasha@gmail.com

Wan Azlina Wan Ismail, Ramly Hasan, Nor Hamizah Abdul Hamid, Nor Diana Aziz, Muhamad Hilmi Mohamad @Masri

Faculty of Architecture and Ekistics, University Malaysia Kelantan,
Bachok Campus, 16300, Bachok, Kelantan
azlina@umk.edu.my , ramly.h@umk.edu.my , norhamizah@umk.edu.my , dianaaziz@uitm.edu.my ,
muhamadhilmi@uitm.edu.my

Highlight: The creation of themed gateways as tourist attractions has grown in popularity in recent years. Apart from welcoming tourists, one of the primary goals of these gateways is to connect many attractions that would not have the ability to persuade people to spend time and money. Tourism gateways can also serve as routes that offer to bring together a range of activities and attractions under a common theme, therefore stimulating entrepreneurial potential via the creation of additional products and services. Hence, the gateways offer a distinct feeling of identity, transition, and expectation. They should be relevant to the region's natural resources, beautiful vistas, and cultural history

Key words: *walkway, entrance gateway, local history, innovation design, neon light, streetlight*

Introduction

The arrangement of the environment for the gateway elements in relation to the context is referred to as site planning of gateways (adjacent streets, pathways, land uses, buildings, and open space). It entails taking into account the natural environment as well as the road and building framework that comprise the gateway's surroundings. Gateways should be complementary to their surroundings rather than diametrically opposed. In conclusion, gateways indicate the city's access points, major destinations, and communities.

The design of The Neon Tunnel actually is a design that is located at the entrance of an area. The design focused on a unique design and able to provide attractiveness in the surrounding area. The neon tunnel is a unique and attractive place that have a sense of welcoming because it is symbolic towards the diversity of harmony through the variation colours by the neon light. While the use of wood element represent the traditional and modern culture of Batu Gajah. Hence, the shape of the tunnel represent the railways during the tin mining in the ancient time. The gateway is an essential component of both urban and rural infrastructure. With the addition of lighting element contributes to the creation of a safe environment for both pedestrians and cars. Many gateway across the world are being upgraded with the addition of LED lighting, which consumes less energy and is more dependable than old sodium lamps, lowering the cost of maintaining roadways lighted substantially. By the interesting view that bring the sense of joyful if can be commercial by promoting it into the social media platform.

Acknowledgement

First and foremost I am extremely grateful to my lecturers, Lar. Dr Ramly bin Hasan for their invaluable advice, continuous support, and patience during my study. Their immense knowledge and plentiful experience have encouraged me in all the time of my academic research and daily life. I would also like to thank Dr. Wan Azlina binti Wan Ismail and Dr. Nur Hafizah binti Ramle for their technical support on my study. I would like to thank all the members. It is their kind help and support that have made my study and life in the UMK a wonderful time. Finally, I would like to express my gratitude to my parents, and my siblings. Without their tremendous understanding and encouragement in the past few years, it would be impossible for me to complete my study.

References

Hao Chen, Xueqin Jia and Heng Li, (2011) A brief introduction to IoT gateway', Communication Technology an Applicatio
[Arlene Rubin Stiffman](#), [Bernice Pescosolido](#) & [Leopoldo J. Cabassa](#) (2004, Building a Model to Understand Youth Service Access: The Gateway Provider Model

GERBANG MEK MAS AS A NEW ICONIC STRUCTURE AT KAMPUNG PANTAI MEK MAS, KOTA BHARU

Muhammad Aslam Husaini Mohd Sapuan

University Malaysia Kelantan, Bachok, Malaysia
aslamsapuan706@gmail.com

Ramly Hasan, Wan Azlina Wan Ismail, Syahidah Amni Mohamed, Nor Diana Aziz

University Malaysia Kelantan, Bachok, Malaysia
ramlyhasan80@yahoo.com, azlina@umk.edu.my, amni.m@umk.edu.my, dianaaziz@uitm.edu.my

Highlights: Facilities in a village are very important to provide convenience to the villagers. The facilities provided can provide opportunities for the villagers to generate income. Therefore, Gerbang Mek Mas can give guidance and attract the attention of visitors as well as show the identity of this village as a fishing village. In addition, this iconic sculpture can also increase the aesthetic value of this village as a unique fishing village.

Key words: *Gerbang, entrance, history, identity, tourist, local communities.*

Introduction

Gerbang Mek Mas is a new iconic structure gateway in Kampung Pantai Mek Mas and become main focal point before the tourist go to another cultural and heritage place. Gerbang Mek Mas also can identify entrance points to the village and key destinations as well as its neighbourhood. It represents the Mek Mas story and Kampung Pantai Mek Mas as a fishing village. Gerbang Mek Mas can bring back the history of Mek Mas based on the characteristics of Gerbang Mek Mas.

The first characteristics of Mek Mas is fish trap or "Bubu". Bubu is tools for catching fish. It's like a basket that allows fish to get into it but is blocked for fish to get out. Mek Mas use the "Bubu" to catch the fish. The second characteristics of Mek Mas is Batik motive. It is a type of cloth that worn by Mek Mas when she explored the village by catching the fish at the river. The third characteristics of Mek Mas is water. The element was taken because Mek Mas catch the fish at the river. The last characteristics of this Gerbang Mek Mas is "Perahu". It represents the culture of Kampung Pantai Mek Mas as a fishing village.

Gerbang Mek Mas is important for the education because it can be a guideline to be implement at suitable cultural and heritage design especially for the landscape architecture study. It is because at Gerbang Mek Mas there are the element of the cultural and heritage of a place to indicate in cultural and heritage studies. This element is very important to show the identity of the place.

There are many advantages of this iconic structure to the tourist, local community and local authorities. The advantages to the tourist is they can know about the history of "Mek Mas" and Kampung Pantai Mek Mas itself. Next, Gerbang Mek Mas can give new experience and they can take photos at the unique Gerbang Mek Mas. Gerbang Mek Mas also have its advantages for the local communities that is because it can promote business opportunities for the villagers using the characteristics of this structure that symbolize this village as a fishing village. Lastly, the advantages for the local authorities is the can use this Gerbang Mek Mas as a guideline to be implement at suitable cultural and heritage design.

In order to commercial this Gerbang Mek Mas, I try to promote the uniqueness of this Gerbang Mek Mas through social media as that is the latest platform now days. User just need to scan the Qr code and view the page to see the content and some info regarding the Gerbang Mek Mas. I have use the social media that is facebook to promote this iconic structure. There are 4 simple step in order to access to facebook Pantai Mek Mek Mas to see this Gerbang Mek Mas. The step is open the phone menu and than open the Qr code scanner. Next, scan the specific Qr code that has been given and the visitors can get in to facebook Pantai Mek Mas that represent the iconic structure that is Gerbang Mek Mas.

Acknowledgement

Special thank and gratitude for my studio lecturers, LAr. Dr Ramly bin Hasan, Dr Wan Azlina Wan Ismail, Dr. Nur Hafizah binti Ramle for guiding me to complete my innovation project to be successful.

References

- Thompson Monticello (2016) Gateway Corridor Design Guidelines : Grow the Gateways: Strategic Plan for the Gateway Corridor
Kumar, V. (2009) : "A process for practicing design innovation", Journal of Business Strategy, Vol. 30, No. 2/3, pp. 91-100.

SINGGAH JELAPANG AS PARADIGMATIC STRUCTURE AT PENDANG TOWN

Noor Saadah Hussain

Universiti Malaysia Kelantan, Bachok, Malaysia
saadah8995@gmail.com

**Ramly Hasan, Wan Azlina Wan Ismail, Muhamad Hilmi Mohamad @ Masri, Syahidah Amni Mohamed,
Nor Diana Aziz**

Universiti Malaysia Kelantan, Bachok, Malaysia
ramlyhasan@yahoo.com, azlina@umk.edu.my, muhamadhilmi@uitm.edu.my, amni.m@umk.edu.my,
dianaaziz@uitm.edu.my

Highlights: This creative and innovation is a psychological theory of human–environment relations. This innovation defines an individual's physical identity with complex patterns of thoughts, feelings, beliefs, objectives, choices, abilities, and conscious and unconscious behavioural patterns related with certain environment. This innovation is to express cultural identity through local community activities. There are several advantages to expressing cultural identity. These include learn to be tolerant, become more open minded, fostering community trust, and promote respect among people.

Key words: *Place identity, Culture identity, Paddy activities, Community, Regenerating.*

Introduction

Singgah Jelapang is a structure in Pendang town, it is a simple shelter built based on the identity of Pendang town. Before that, a little information about the town of Pendang. Pendang is a town located in the state of Kedah Darul Aman. The population made up of Malay, Indian, Chinese and Siamese. Around it there are verdant paddy plantations. This paddy is an economic resource for the residents around Pendang town. Turning to the purpose Singgah Jelapang earlier, 'Singgah' means stop for a moment somewhere. This shelter will be a place for people to stop for a while or rest for a while before continuing their journey. While, the jelapang was once a storage place for rice harvests. Jelapang are known as paddy houses built with 3 to 4 columns and having 4 to 6 pillars.

The structure is only in Pendang, Kedah. Special value of paddy identity applies surrounded the structure. This structure different from other shelter in term of parts-physical component and it environmental of interaction. The 60% modification from original 'Jelapang' make this new product stand with its own uniqueness and high of aesthetic value. This Singgah Jelapang will bring a sense of nostalgic to the people who have been through the traditional rice harvesting season. When they are in this Jelapang Plaza area, this simple shelter will provide information about the paddy house which is projected on the led screen provided. To foreign visitors and young people, they will see the identity of the town of Pendang in this Singgah Jelapang, then create a bond between the identity of a place with visitors.

Singgah jelapang has 4 concrete bases, 4 wooden poles. It has no enclosed walls and has a weave of the kelarai (sesiku keluang type). This weave is made of bamboo and retains the characteristics of a traditional paddy house. The roof used is nipah roof type. In the old days, paddy houses used nipah roofs because they were easily found, especially around rice fields and swamps. On the side of the Singgah Jelapang there is an abstract carving of a rice tree. This carving will give a stimulus through touch to the child. They can touch and feel every curve of the carving. The height, the built without stairs and the accessibility that ensures the safety of children and persons with impairments. Wind resistance up to 260km/h is certified (160mph). This is appropriate because it is surrounded by paddy fields (wind source). The other advantage is generating income for surrounding traders by encouraging them to sell craft-related products to Singgah Jelapang. Tourists can learn and understand about the culture of rice farming and the Rumah Padi will not be forgotten.

This Singah Jelapang can be commercialized for museum use. In the state of Kedah there is a paddy museum, this is very suitable with the concept of Singgah Jelapang. Singgah jelapang can be used as a permanent kiosk in recreation areas and small public spaces.

Acknowledgement

The success of the project and the final outcomes desperately need the support and encouragement from many people. I am extremely privileged to thank my studio lecturers, LAr. Dr Ramly bin Hasan, Dr Wan Azlina Wan Ismail, Dr. Nur Hafizah binti Ramle for providing me opportunity and giving support which make me complete the project successfully. Thousand thanks to my fellow friends who have provided invaluable assistance throughout the completion of this project.

References

- Daniel Belanche, Luis V. Casalo, María Ángeles Rubio, Local place identity: A comparison between residents of rural and urban communities.
- Eva Duivenvoorden, Thomas Hartmann, Marlies Brinkhuijsen, Ton Hesselmans, Managing public space – A blind spot of urban planning and design
- Maria Della Lucia, Mariapina Trunfio, The role of the private actor in cultural regeneration: Hybridizing cultural heritage with creativity in the city

SMART SCULPTURE BENCH

Siti Fatin Hamida Zinun

Faculty of Architecture and Ekistics
UMK, Bachok, Malaysia
fatinhamida97@gmail.com

Ramly Hasan, Wan Azlina Wan Ismail, Nor Diana Aziz, Muhamad Hilmi Mohamad @ Masri

Faculty of Architecture and Ekistics
UMK, Bachok, Malaysia

ramly.h@umk.edu.my, azlina@umk.edu.my, dianaaziz@uitm.edu.my, muhamadhilmi@uitm.edu.my

Highlights: Every places must has their own identity and history. It also same like Ban Pecah that located at Tanjung Piandang, Perak that keeps a thousand histories that not exposed to other people. Mostly, user like use the beach coast as a recreation area. The limited space and along the coast fully with rock revetment will making it difficult for user to enjoy their activities that attach with the sea. Proposed special space with multifunction product bench will help user more enjoy while using the area, At once can exposed knowledge about the history and the uniqueness of this place. In addition, this product will attract user especially tourist that also can generate local income.

Key words: *Ban Pecah, historical, sculpture benches, creative and innovation.*

Introduction

'The Smart Sculpture Bench' is a sitting product that special created as a memorable of history. The sculpture bench also the only product that located at Ban Pecah village, Tanjung Piandang, Perak. The design has inspired by the history of Ban Pecah, which is the erosion that happen to this village get a named and this village, become as attraction place for leisure and relaxing mind. The creation of the product also can be as a landmark at this site because the product is a big sculpture that very creative while apply the shape of the wave. In addition, the sculpture also provide comfortable space for sitting.

This creative of this design about the big shape of sculpture bench that was function as new landmark at this site; also provide space for sitting during the day and night. Combination of sculpture bench was create the multifunction that very uniqueness and useful. Based on current situation about pandemic covid-19, the design space for sitting also limited. Certain space was provide planting plant, which is the plant of *Portulaca grandiflora* to raise the aesthetic view. This design will help to reduce crowded people and at the same time provide the best service for user.

The innovation of the design also provide automatic sanitize mist spray at top of the rod, when the sensor motion detect the user used the bench also the sensor will detect user that used the area 1 meter from the bench. In addition, the sensor also work in every 2 hour when nobody at this area, that innovation will help to reduce risk of virus spread and improve the sustainable of environment.

This product also provide space for digital information board, and provide QR code for user access it into Facebook page. It also improve the commercialization of this site and will improve the local economic. Besides that, the product also has advantage to local authority that they can use it as a landmark for promote this site to expose it to tourist attraction. While, advantage for tourist is enjoy the space for relaxing area. During the night, this product also provide lighting to improve the safety and aesthetic view from the neon light rod and warm light from the sphere light. The product also can be one of the attraction at Ban Pecah for relaxing, get information of the historic Ban Pecah, and provide port for taking picture.



Figure 1.0: Design of Smart Sculpture Bench

Acknowledgement

Foremost, I would like to express my sincere gratitude to my lecturers, LAr, Dr Ramly bin Hasan, Dr. Wan Azlina Wan Ismail and Dr. Hafizah ramle for their patient and proper guidance to achieve this innovative design project. I also thanks to my classmate That always give advice and insights to help me in produce the best product.

References

- Y.H Brian Leel, L.H. Denise Chan, M.X. Tang 2013 Park Seating Furniture Design in Hong Kong: A Case Study of Inclusive Design and its Relation to User Interaction, The Hong Kong Polytechnic University
- D.H Deborah, M. Andy, 2018, The Board's Role in Shaping Digital Transformation: <https://www2.deloitte.com/content/dam/Deloitte/us/Documents/center-for-board-effectiveness/us-the-boards-role-in-shaping-digital-transformation.pdf>

TRADITIONAL ELEMENT OF MALAY TERENGGANU: INTRODUCING *GAZEBO PERMAI* AT SUNGAI TAROM PUBLIC PARK, SETIU, TERENGGANU

Mohamad Hazmie Bin Rusdi

University Malaysia Kelantan,
Bachok Campus, 16300, Bachok, Kelantan, Malaysia
hazmierusdi@gmail.com

Wan Azlina Wan Ismail, Ramly Hasan, Nor Diana Aziz , Mohd Azri Mohd Jain Noordin

Faculty of Architecture and Ekistics, University Malaysia Kelantan,
Bachok Campus, 16300, Bachok, Kelantan
azlina@umk.edu.my, ramly.h@umk.edu.my, dianaaziz@uitm.edu.my, azri.mjn@umk.edu.my

Highlights: A gazebo is a pavilion structure, sometimes octagonal or turret-shaped, that is commonly built in a park, garden, or large public area. The weather outside can change quickly, and a sudden rainstorm can easily ruin a fun day at the park. Include a gazebo to guarantee that visitors are protected from a sudden downpour. The shade provided by the covered roof is particularly beneficial for those who spend too much time in the sun. Gazebo design is taken from an existing element in Terengganu Malay traditional house near the park area. Besides, Gazebo is also made so that the user can feel the situation in Terengganu Malay traditional house even just gazebo. This gazebo was likewise built to display or demonstrate the park culture.

Key words: *Public Park, traditional Malay house Terengganu, elements, Local, Tourist*

Introduction

A gazebo is a pavilion construction that is commonly found in a park, garden, or large public space. In the summer, this tiny roofed house with screens on all sides is ideal for outdoor entertaining and dining. A wonderful spot for you and your family to get together, relax, and unwind after a long day at work.

A gazebo is a structure that resembles a house and is used as a shielded area from rain and heat or as a covered picnic spot. Therefore, the construction of a Gazebo Permai differs from that of other gazebos. Gazebo Permai, inspired by numerous characteristics found in a Terengganu Malay traditional house located near the Sungai Tarom Public Park. A foldable table has been installed on this gazebo to make it easier for people to perform things like study, picnic, or meetings. In addition, when not in use, this folding table can be bestowed. Following that, solar energy has been added to this gazebo for the use of electrical energy so that users can charge gadgets or other applications such as lights, fans, and so on. Advantages this gazebo for local is as a sheltered area from rain and heat. This can be used by students as a study area or as a safe area for students to wait before their parents pick them up. For tourist is a wonderful place to get together, picnics, and learn about the element of Traditional Malay Terengganu. Promote this product to Majlis Daerah Setiu to be sold to a landscape architect consultant in order to generate income.

Acknowledgement

Special thank and gratitude for my studio lecturers, LAr. Dr Ramly bin Hasan, Dr Wan Azlina Wan Ismail, Nor Diana binti Aziz and Mohd Azri bin Mohd Jain Noordin for guiding me to complete my innovation project to be successful.

References

- Penselpatahtunteja (2016). Rumah 'Tele' Tradisi Bangunan Melayu Terengganu. Blogs.
<https://penselpatahtunteja.blogspot.com/2016/11/rumah-tele-tradisi-bangunan-melayu.html>
- Lisa Hallett Taylor (2021). What Is a Gazebo Used For?. Blogs.
<https://www.thespruce.com/what-is-a-gazebo-used-for-2736944>

AGRONOMICAL SHELTER AS AN EDUCATION CENTER FOR URBAN FARMING AWARENESS

Amirul Hidayat Hussin

Faculty of Architecture and Ekistics, University Malaysia Kelantan,
Bachok Campus, 16300, Bachok, Kelantan, Malaysia
amirulhidayat0@gmail.com

Wan Azlina Wan Ismail, Ramly Hasan, Noorliyana Ramlee, Nor Diana Aziz

Faculty of Architecture and Ekistics, University Malaysia Kelantan,
Bachok Campus, 16300, Bachok, Kelantan
azlina@umk.edu.my, ramly.h@umk.edu.my, liyana.r@umk.edu.my, dianaaziz@uitm.edu.my

Highlights: As people become more conscious of the food supply chain and its influence on the environment, it becomes evident that much more work is required to make a significant change. By localising crop supply, urban farming aims to reduce the carbon footprint associated with mass production and distribution. In addition to tackling challenges of urban food insecurity, the concept aims to make healthy food both affordable and accessible to those who need it. In 2018, urban farming is a contentious topic. When you consider the rise of the eco-friendly movement, which has been fuelled by increased awareness of global warming, as well as the global economic climate over the last decade, the trend toward sustainable living makes perfect sense.

Key words: Agronomic, urban farming, bamboo, Shelter, garden enhanced learning, sustainable

Introduction

The current demand for food in the world and the need to conserve natural resources guide the science and technology community to seek strategies for sustainable farming, that is economically profitable, socially just and environmentally friendly. Agronomical shelter was designed to increasing interest in garden-enhanced learning and a place for gathering and workshops to reconnect communities with the natural environment and improve health outcomes. The communities who live in this area developments can become urban farm customers, gaining access to fresh produce grown in their communities and learning about sustainable living and urban farming from specialists. Agronomical Shelter also focuses on food and agricultural entrepreneurship innovation. Besides, under the agronomical shelter another technology was provided such as hydroponics, which involves growing plants in a water-circulation system. There is no need for soil and may stack up to 12 plants vertically in a tiny area. Bamboo is the main material utilised to construct the agronomical shelter. Bamboo will assist both our home garden and the environment if we use it to create a more visually appealing garden. This is because bamboo is an environmentally beneficial and long-lasting gardening alternative. Bamboo absorbs and produces more carbon dioxide and oxygen than most plants. Other than that, it is termite, insect, and wear resistant, and can last for over 20 years.

Besides that, the agronomical shelter has a few design principles applied to the innovation through a 13-meter shelter that maximizes sunshine and natural ventilation, the idea blends produce production into the area. Recognizing the shrinking agricultural acreage in the developing globe, the concept intends to address the growing need for crop farming in urban areas. In terms of the material used, this designed shelter uses bamboo as the main construction material, Tetra Pak Peel roof as the roofing, onduclair for lighting resources, solar panel for energy source, and hollow blocks for flooring. In general, Bamboo is a renewable resource that can assist to reduce deforestation by growing quickly in the correct conditions. Bamboo, in fact, can reach full maturity in as little as seven years, which is a very short period when compared to most tree species. The pace of growth of a plant is significant since it reflects how rapidly the plant may replace wooded areas. Without the use of specialized tools or equipment, bamboo is simple to cut, handle, repair, reposition, and maintain. The bamboo's natural surface is smooth and clean, with a pleasing hue that does not require painting, scraping, or polishing. For the dimension of this Agronomical Shelter. Overall height is about 3800mm, and the length is about 13000mm as shown in the (figure 5.8). Tetra Pak Peel Roof is a roofing material manufactured from used beverage cartons that are recycled into corrugated roofing sheets. Next, for daylighting, transparent roof sheets enable natural light into the space, which has been strategically placed to maximize solar collection for the indoor plants while reducing glare and heat gain. Some areas of the roof will be covered with clear roofing sheets (ondocclair), which will let natural light inside the bamboo shelter, allowing the plants to thrive. The solar panels utilized in this shelter are intended to provide an energy source for the grid system, which will power lights, fans, and other light-duty utilities. For the flooring, the material used is hollow blocks. These concrete blocks are lighter than traditional blocks because they are made of concrete. These hollow blocks help trap air, resulting in a cooler wall or floor.

This innovation has a positive impact on not only the economy, but also on some of the communities involved. This shelter has the potential to provide employment possibilities for members of the B40 community as well as local farmers. Next, it also can provide education and raise awareness about the value of urban agriculture. Government policies can increase the incentives to innovate, including guaranteeing intellectual property rights, government assistance with the costs of research and development, and cooperative research. Furthermore, local authorities or governments might utilize it as a guideline to adopt in appropriate urban areas.

We use Pinterest to advertise the uniqueness of this agronomical shelter because it is the easiest platform to use these days. All the user must do is open their camera and point it at the QR code, then wait for the camera to recognize it. Scanning and viewing the page will reveal the content as well as certain information such as views and the agronomical shelter's distinctiveness. On the other hand, user can learn about their home garden and participate in weekly activities at the agronomical shelter.

Acknowledgement

Thank you to my studio lecturers, LAr. Dr Ramly bin Hasan, Dr Wan Azlina Wan Ismail, and Dr. Nur Hafizah binti Ramle, for helping me to a successful completion of my innovative project. Also, a special thanks to my supervisor for collaborating in this project with me.

References

- Giller, Ken & Hijbeek, Renske & Andersson, Jens & Sumberg, James. (2021). Regenerative Agriculture: An agronomic perspective. *Outlook on Agriculture*. 50. 10.1177/0030727021998063.
- Glowa, K.. (2019). Urban Farming. 1-6. 10.1002/9781118568446.eurs0364.
- Singh, Lal & Jaiswal, Anoop & Thul, Sanjog & Purohit, Hemant. (2017). Ecological and economic importance of bamboos..
- Rogers, Mary. (2018). Urban Agriculture as a Tool for Horticultural Education and Youth Development. 10.1007/978-3-319-67017-1_9.

SOLVING THE COASTAL EROSION AND SUSTAIN THE COASTAL ECOSYSTEM THROUGH THE ECO FRIENDLY DEFENDER AT PANTAI IRAMA, BACHOK, KELANTAN

Leong Kam Hung

Faculty of Architecture and Ekistics, University Malaysia Kelantan,
Bachok Campus, 16300, Bachok, Kelantan, Malaysia
cnut82051@gmail.com

Wan Azlina Wan Ismail, Ramly Hasan, Noorliyana Ramlee, Nor Diana Aziz

Faculty of Architecture and Ekistics, University Malaysia Kelantan,
Bachok Campus, 16300, Bachok, Kelantan, Malaysia
azlina@umk.edu.my, ramly.h@umk.edu.my, liyana.r@umk.edu.my, dianaaziz@uitm.edu.my

Highlights: Breakwaters are designed to limit wave energy reaching the shoreline by dispersing, reflecting, or diffracting oncoming waves, allowing for better deposition and the implementation of low-wave energy uses. On the Pantai Irama Waterfront have several breakwaters that have been provided to prevent erosion from occurring which this structure is made up of a big pile of rocks that runs parallel to the shore. The structure is works well but to create a sustainable coastal ecosystem I have created a more creative breakwater design and give a diverse impact on the environment on the Pantai Irama Waterfront.

Key words: *Breakwater, Eco-friendly, Coastal ecosystem, Sustainable landscape, Aesthetic*

Introduction

The new breakwater design name as Eco-Friendly Defender. This structure is created by mixed of creative idea and unique technology which this structure can be locate along the sea. Eco-Friendly Defender is a structure constructed for the purpose to protect the shore area from the effect of sea waves. This structure is using 3 type of material which is large rock, eco armor block, and tide pool armor. Eco armor block is an eco-friendly technology designed with tiny hole for the small fish live around it, seaweed grow on top of it, coral and oysters appear around it, and marine life thrives. Tide pool armor add beautiful water retaining features to breakwaters, riprap, and revetments. It bring life by retaining water at low tide and create "hot spot" for biology. This structure also using the Headland Breakwater type which is an attached fashion to the shoreline and the shoreline behind the structures will evolves into a natural form. For the form design, from the typical form of breakwater turn into a new form of breakwater which can protect marine life for example create reef movement for the fish. Eco-Friendly Defender is suitable install at the long beach shoreline where more than one breakwater unit can be install. Eco-Friendly Defender not just protect shore area from the wave disturbance and collect sand but it also give a lot of advantages to the environment for example it is a sustainable solutions for coastal and marine life by providing habitat for ecosystem. It also transform a new form which provide aesthetic value to the coastline look. Then, this structure also help increase awareness of risk, empower citizens, and engage local schools in waterfront education. Through the nowadays technology this Eco Friendly Defender can be promote by scanning the QR code that provided at the shoreline area. It is also an easiest platform for student to learning.

Acknowledgement

Big thanks I address to my lecturers, Dr Ramly Bin Hasan, and other lecturer Dr Wan Azlina Binti Wan Ismail and Dr Nur Hafizah Binti Ramle who give me opportunity to participate and do this project for this competition. Without their guide my project cannot be done properly like this. They always give me supports and guide to me how to done this creative and innovation project in purpose to produce a good outcome. Finally thanks to my beloved family that always support me when I having problems and continue to inspire so that my project can be completed. Million thanks also I wish to all my classmate because they also help me in doing this project and keep comment on my design and give idea.

References

- Adhalina, N. (2011). The Different Language Style and Language Function Between Students and Teachers in Updating Their Status In Facebook Webpage (A Case Study of the Topic National Final Examination 2011)(Doctoral dissertation, University of Diponegoro).
- Alessandra, A. J., O'Connor, M. J., & Van Dyke, J. (1994). People Smarts: Bending the Golden Rule to Give Others what They Want. Pfeiffer.

DESIGNING CREATIVE ONE STOP GETAWAY AT DANGA BAY WATERFRONT

Muhammad Firdaus Rahim

Faculty of Architecture and Ekistics, University Malaysia Kelantan,
Bachok Campus, 16300, Bachok, Kelantan
Firdausrahim1997@gmail.com

Wan Azlina Wan Ismail, Ramly Hasan, Nur Hafizah Ramle, Nor Diana Aziz

Faculty of Architecture and Ekistics, University Malaysia Kelantan,
Bachok Campus, 16300, Bachok, Kelantan
azlina@umk.edu.my, ramly.h@umk.edu.my, zah_an@yahoo.com, dianaaziz@uitm.edu.my

Highlights: The recreation area here can attract many visitors. However, here there is still no special area for those who come by public transport. In addition, civic awareness is still lacking among adolescents as well as the general public. Therefore, the technology applied in this innovation is done to overcome the problem and help the municipality in curbing this problem. This step can also help to achieve a more sustainable vision of a smart city.

Key words: *Technology, smart city, sustainable, civic awareness, and public transport*

Introduction

A bus stop is a designated location where buses stop to allow passengers to board and disembark. Bus stops are typically built to match the degree of usage, with shelters, seating, and possibly electronic passenger information systems at busy areas and a simple pole and flag to designate the location at less popular locations. In some areas, bus stops are crowded together to form transportation hubs, allowing for interchange between routes from surrounding stops as well as with other modes of public transportation to maximise convenience. This innovative structure can be found on the Danga Bay Waterfront. With the wide range of functions available, this beautiful structure is also equipped with modern features and is in line with the new norms we are practicing now. This structure will be a pilot design for other modern cities in building a bus stop structure.

The Innovation product are located at the left hand side of the masterplan which is near to the entrance. The unique elements this structure is the bus stop is integrated with renewable solar energy which all the lighting and electrical things are depends. This structure acts as a flexible bus stop where users can get info and benefit while using this area. Also comes with some security features for users. There are some unique features that integrated with such as water fountain, electronic display, qr code scanner, cctv surveillances and smart vending machines. The advantages that are people are getting from my invention is there are technology where people can use such as electronic display. There will be no more wasting time to waiting for a bus. There will be schedule list that can benefit for them.

In addition, there is a technology that is innovated to address the civic awareness that is still lacking among adolescents and the general public. For example, garbage dumped in inappropriate areas has given a bad visual first impression to visitors and especially tourists. Next, a vending machine that uses a sustainable approach was created to help reduce this problem from continuing to occur. Therefore, the technology applied in this innovation is expected to help the municipality in curbing this problem. This step can also help to achieve a more sustainable vision of a smart city. This technology is also expected to be a pilot design for the city council in the state of Johor.

Acknowledgement

I would like to thanks the lecturers, Lar. Dr. Ramly Bin Hasan and Dr. Wan Azlina Binti Wan Ismail for their guidance throughout this semester, a lot of information, and positive talks. I can consider that I am lucky that have the opportunity to learn and gain as much knowledge as I can with my lecturers. I also feel very grateful because I have met with a very positive and humble person who has helped me pass through this task. I would also like to thank my parents, who have supported me from the day I start my studies fill the end of my studies. Also, I want to thank my fellow friends who gave me valuable feedback on my research design.

References

- Brolin A , Mithun R , Gokulnath V and Harivishanth M 2018 .Design of automated medicine vending machine using mechatronics techniques 2nd International conference on Advances in Mechanical Engineering (ICAME) pp. 1–7.
- Farid HH 2011 A Study on Developing Certificate Vending Machine by using Student Smart Card (Case Study: UIN Syarif Hidayatullah Jakarta) (UIN Syarif Hidayatullah Jakarta)
- X. Chi, S.P. Martin, Y.L.W. Mark, A.R. Markus, Informal Electronic Waste Recycling: A sector Review with Special Focus on China, Waste Management, 2011,31,pp. 731–742.
- Z. Tarmudi, M. L. Abdullah, A. O. M. Tap, An Overview Of Municipal Solid Wastes Generation In Malaysia, Jurnal Teknologi, 2009, 51 (F), pp. 1–15

THE BEAUTY OF BUNGA BINTANG HYPNOTIC AT ROYAL TOWN, PEKAN PAHANG.

Farah Amirah Kasimi

Faculty of Architecture and Ekistics, Universiti Malaysia Kelantan,
Bachok Campus, 16300, Bachok, Kelantan, Malaysia
farahamirahkasimi@gmail.com

Ramly Hasan, Wan Azlina Wan Ismail, Nor Hamizah Hamid, Yeo Lee Bak, Nor Diana Aziz

Faculty of Architecture and Ekistics
ramly.h@umk.edu.my, azlina@umk.edu.my, norhamizah@umk.edu.my,
yeoleebak@umk.edu.my, dianaaziz@uitm.edu.my

Highlights: The product innovation sculpture name is 'Bunga Bintang Hypnotic' proposed to locate at Royal Town Pekan, Pahang. The uniqueness of the sculpture can provide a sense of welcome when visitors are visiting it. It can act as a landmark, recreational activity gathering space and Instagram-able place. The form of the sculpture was inspired by the motif 'Bunga Bintang Tenun', such as the dress Pahang Royal to show the local identity of a Royal Town. The iconic sculpture may strengthen social bonds and attracting tourists and local communities to visit the space. This sculpture creates a full spectrum of light at night and becomes a cultural node of interest.

Key words: *Sculpture, Bunga Bintang, attraction, recreation, tourists, Digital HFTS.*

Introduction

Bunga Bintang Hypnotic is a new iconic structure in the Royal Town, Pekan Pahang a central focal point for social and attraction. Tourists and local communities can explore relaxation and sometimes can control the standard operating procedure for visitors. The sculpture provides sound free can detect from digital HFTS (Hand, Face, Temperature Control and Social Distance technologies), a standard operating procedure to control such as social distance, temperature control, face mask, and hand sanitiser. The material is recycled, safe and of high quality. The Bunga Bintang Hypnotic sculpture membrane system, practically and aesthetically, and its adaptability and multipurpose performance will allow it to be used as a social centre in the public realm. Since it faces up to the central plaza, the site is significant, which has a museum with water elements, maximising the user's experience.

Besides that, the sculpture Bunga Bintang Hypnotic has three design principles applied to the innovation: a relaxing area, sense of identity, and Digital HFTS. At night, this sculpture has colourful lighting and is very beautiful and gives a sense of relaxation for people. The sculpture roof is combined from a pergola design that provides shelter. The motif design is joined hand with the effort of 'Tenun', motif flora the royal 'tenun', lighting colourful at night attraction local, community and tourist, bring to the memorial the value a traditional commemoration of the symbolic heritage of the dress Royal Pahang. The sculpture explicitly designed to show the identity of Pahang in Pekan Royal Town. This iconic sculpture with the element motif of 'tenun', bring a sense of identity to the place. This Bunga Bintang Hypnotic provides an intriguing and memorable moment to those who visit the Pekan Royal Town, and visitors can scan the QR code to know its history. Besides, it is suitable for recreational uses as well. The element material used meranti wood, chengal wood, waterproof concrete, LED Sign Controller, aluminium, Volt Magazine dan PCB (Electronics). The material is high quality and safe for the environment. Overall height is about 17000mm, and the length is about 1600mm.

This innovation not only has an aesthetic influence but also benefits local communities and tourists in safety aspects. This sculpture also gives control settings to comply with SOP rules set by the government. The local authorities or government can adopt this design elsewhere, like a plaza or park, to monitor the safety of the people with advanced technologies and enhance the place identity. This innovation integrated social media to advertise the uniqueness of the Bunga Bintang Hypnotic sculpture. The viewer only needs to scan the QR code and browse the page to see the content and information about Bunga Bintang Hypnotic, including news, history, and other details.

Acknowledgement

Thank you to my studio master, LAr. Dr Ramly bin Hasan, Dr Wan Azlina Wan Ismail, and Dr. Nur Hafizah binti Ramle, for helping me to successful completion of my innovative project.

References

- Jane Zheng. (2017). Contextualising public art production in China: The urban sculpture planning system in Shanghai.
David Herbert University of Wales, Swansea, UK. (1993. Annual Joint Conference of the Royal Town Planning Institute and the Landscape Institute, 'Landscape Challenge of the Urban Fringe', London, UK, 30 April 1993
- Ali, M (2017). The Sculptures figurines and figures created based on computer games, blockbusters and animated films. The sketch-sculpt and Art-sculpt and Digital Sculpting the in Facebook webpage (Fan Art-Sculpture-Digital Sculpting) (Beauty sculpture attraction, Indonesia)

SOLVING THE SOIL DEPOSITION THROUGH THE SUSTAINABILITY OF RESILIENCE DRAINAGE SYSTEM AT BUKIT KELUANG BEACH, BESUT, TERENGGANU

Ahmad Huzaifah Aminuddin

Faculty of Architecture and Ekistics, University Malaysia Kelantan,
Bachok Campus, 16300, Bachok, Kelantan, Malaysia
Huzaiyah9787@gmail.com

Wan Azlina Wan Ismail, Ramly Hasan, Nor Diana Aziz, Mohd Azri Mohd Jain Noordin

Faculty of Architecture and Ekistics, University Malaysia Kelantan,
Bachok Campus, 16300, Bachok, Kelantan, Malaysia
azlina@umk.edu.my, ramly.h@umk.edu.my, dianaaziz@uitm.edu.my, azri.mjn@umk.edu.my

Highlights: Nowadays, drainage system is one of the most important elements for landscape design, architectural and engineering building where it can be useful as to sustain every surface and can be avoid any soil deposition or soil erosion. In Bukit Keluang beach, the surface of recreational area where the type of soil is sandy soil more likely to have an issue that will cost a soil deposition in the future. So, to resolve the problem of soil deposition, the space need a good sustainability of drainage system where on my design, I had created a resilience drainage system where it can sustain the space for a long time and the movement of water can move smoothly without experiencing any interference.

Key words: *sustainability, resilience, drainage system, coastal erosion, ecological, public realm*

Introduction and Content

The design of resilience drainage system is used a unique type of drainage where the drainage system can support much water once a time. To make a difference of typical septic tank and resilience drainage system is for the septic tank, the water flow is slow, and the process of filtration is a take a lot of time because of it cannot support a lot of wastewaters once a time. But for the Resilience drainage system, the flow of water movement is fast, and the process of filtration is faster and take less of time. This is because the drainage canal size can fit a human diameter and is enough to make water go down without experiencing waterway obstruction. A big size of sump tank also makes this drainage can cover a lot of water for once a time. Besides that, the used of material also are important to produce the resilience drainage system. The creation of water sump is using concrete because it is durable enough to withstand gravity on the surface of the recreational area where there are various activities performed by humans. For the material of underground water flow is by using Underground Coated Steel Pipe (UCSP) where it can be used for 50 - 100 years. So, it suitable for used of water irrigation flow. By using this material does not require a lot of cost for maintenance because it is a sustainability steel material. The advantage of resilience drainage system on term of environment is it is a kind of system that is eco-friendly to the environment because it can trap garbage and prevent water pollution to the river. The system also can prevent soil deposition and also prevent soil erosion. For advantages in term of local people, the space of recreational area will not have water reservoir so it can create an activity for human.

Acknowledgement

I would like to express my gratitude to my lecturers, Dr. Ramly bin Hasan, who gives me a golden opportunity to participate and do this wonderful project for this project competition. They also always support behind me, give an invaluable advice, helping us and be patience during the creative and innovation project. I also would like to express my gratitude toward to both of my family because supporting behind my back when I need them the most and always give some advice to stay strong for making this project of innovation. I am also over helmed in all humbleness and gratefulness to acknowledge my depth to all those who have helped me and participate with me, give some idea to improve my innovation and continuous support.

References

- Adhalina, N. (2011). The Different Language Style and Language Function Between Students and Teachers in Updating Their Status In Facebook Webpage (A Case Study of the Topic National Final Examination 2011)(Doctoral dissertation, University of Diponegoro).
- Alessandra, A. J., O'Connor, M. J., & Van Dyke, J. (1994). People Smarts: Bending the Golden Rule to Give Others what They Want. Pfeiffer.

DEVELOPMENT OF POSTURE CORRECTOR DEVICE WHILE SITTING FOR DISCOMFORT PROBLEMS AMONG OFFICE WORKERS

Darlina Mohamad

Universiti Malaysia Kelantan, Bachok, Malaysia
darliana.m@umk.edu.my

Azmul Fadhli Kamaruzzaman, Nooraziah Ahmad, Hana Yazmeen Hapiz, Mohd Yusri Mohd Naser

Universiti Malaysia Kelantan, Bachok, Malaysia
azmul@umk.edu.my, nooraziah@umk.edu.my, yusri.mn@umk.edu.my

Highlights: Seating comfort awareness is one of the important factors to be considered in ensuring a good office work environment. Previous research had found that working in sitting condition for a long period of time with awkward postures might cause back pain problems. SOCSO had reported that employees in Malaysia from 2012 recorded about 448 cases involving back pain. This problem increased significantly in 2014 with 675 cases. This study was conducted to ensure a good sitting posture is practised during office work. The objectives of this study are to survey the postural discomfort experienced during sitting office work and to develop a device to ensure good sitting posture. A survey was done to collect related information related to sitting office work among respondents and the fabrication process of corrector devices was conducted. The outcomes of this research are expected to benefit office workers to ensure comfort when doing office work in a sitting position to increase employee performance and productivity.

Key words: *sitting posture, ergonomic, comfort, office workers, backpain*

Introduction

This study is focusing on office workers that are exposed to sitting position for a longer period of time in awkward posture. SOCSO had reported that employees in Malaysia from 2012 recorded about 448 cases involving back pain. This problem increased significantly in 2014 with 675 cases. Throughout the early part of the twentieth century, skeletal muscle disorders (WMSDs) were a major emphasis in the prevention of occupational diseases following poor exposure (Colombini & Occhipinti 2006). This condition can result in pain and disability in parts of the body such as the neck, shoulders, elbows, arms, wrists, hands and so on (Buckle & Devereux 2002). Information on comfort and inconvenience is relatively limited for end users of a product such as clothing, kitchenware, electrical goods, workplace equipment as well as vehicle or office seats (Vink & Hallbeck 2012). Comfort is important in the development of furniture products especially on the part of the chair. Vink et al. (2005) argue that comfort is the feeling of pleasure experienced by consumers during or after working with a product. Comfort is one of the important factors to be considered in furniture development, especially chair or seat. There had been many past research that studied comfort while sitting using ergonomic measurement. Most of the outcome of these studies had been successfully used to produce good ergonomic chairs for users. However, certain users still do not practise good sitting behaviour while sitting even using a good ergonomic chair. Most offices have been equipped with comfortable chairs but due to the attitude of employees who do not practice proper sitting posture, the problem of back pain still occurs.

There are many different methods for measuring comfort. In general, it can be categorized into two types of measurement namely subjective and objective measurement. Subjective measurement is obvious because it usually uses survey forms to ask subjects directly whether they are comfortable or not (Richards 1980). Some of the proposed measurement objectives are vibration, interface pressure, muscle activity, posture and movement, electromyography, spinal load contraction and leg swelling (Fai et al. 2007; Looze et al. 2003). Many academics have undertaken studies on posture and ergonomic assessments to evaluate comfort while sitting (Graf et al. 1995; Vergara and Page 2000; Ahmadi et al. 2016).

This study is to survey the postural discomfort among office workers and to produce a device to ensure that the problem can be overcome. This study had combined ergonomic assessment and Arduino method to ensure good sitting posture was practised among users during office work sitting position.

Research Development

The Survey Questionnaire Development

The survey was conducted through online medium platform that is the Google Form. An online platform was chosen due to Movement Control Order (MCO) that had been enforced in Malaysia recently due to Covid-19 spreads. The questionnaire was distributed to respondent around Malaysia. The developed questionnaire is divided into 4 parts that are; Part 1: Demographic Profile, Part 2: Feedback on Sitting Work, Part 3: Feedback on Chair Physical Appearances and Part 4: Feedback on Body Discomfort. A total of 158 respondent were involved in the survey with 95 males respondent and 62 females respondents. Respondents were adult from 20 to 60 years old that involved in doing office work while sitting whether working on salary or working independently. Most of the respondents are working in public sector with 48% and mainly working from home and from office with 49.7% and 40.8% respectively. Respondents had reported duration of sitting while working in a day around 5 to 6 hours and sitting breaks reported in an hour by respondents is showing an response of 45.9% for less than 3 times perhour break which is not recommended for good sitting break time that is every 20 minutes. Besides that, most respondents with 66.9% said that their employer do not take measures in assisting to reduce sitting time at work and limit the time to sit for long periods. From the result had shown that only 14.6% respondents are applying leaning back posture at all time during working. Apart from that shows that 17.2% are rarely leaning back and 68.2% choose working posture that applied both position. From the body part discomfort survey using Cornell body discomfort (Shariat et al. 2018) had shown that mostly respondents experienced discomfort in the neck and shoulder area about 1-2 times last week with 44.6% and 42.7% respectively. Besides that, lower back area also one of the body part usually experienced discomfort by the respondents with 3-4 times last week.

The Arduino Sensor Device Development

A device using Arduino sensor was developed to assist user's to practise good sitting posture. The Arduino coding programmed for seat sensor developed is written in C. Two infrared sensors were used in the device that will detect the obstacle that is the human contact on the seat. The Arduino microcontroller are programmed to suit the required working procedure that has been summarized as in Table 1 below.

Table 1: Seat Sensor Device working procedure.

Condition	Detect Obstacle		
	Sensor IR 1	Sensor IR 2	Buzzer
Condition A	Yes	Yes	Off
Condition B	Yes	No	On
Condition C	No	No	Off
Condition D	No	Yes	Off

Sensor Infrared 1 was assembled on seat pan while Sensor Infrared 2 was assembled on seat back as shown in Figure 1. Based of working procedure in Table 1, the buzzer will activate when in Condition B only which is when the users sit on the seat pan but do not lean on the backrest. This device can be assembled on almost every type of seat or chair as long as the seat is equipped with backrest.

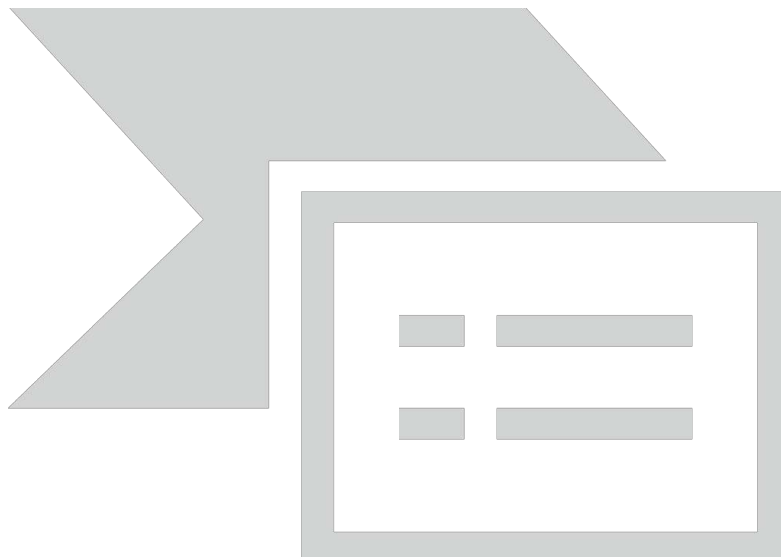

Figure 1: Sensor Infrared placements on seat.

Commercialisation

This developed seat sensor can be marketed for the end user in the community. The targeted users are individual that involved working in sitting position for a long duration of time. The finished product is easier to be used and can be assembled into any kind of seat as long as the seat was equipped with backrest.

Novelty

This posture intervention product is one of its kind because of its easy to use and simple mechanism. This product can be marketed for a wide range of market due its affordability.

Acknowledgement

UMK RISING STAR Grant had funded this research with grant number R/STA/A0200/01699A/002/2020/00781.

References

- Ahmadi, M., Zakerian, S.A., Salmanzadeh, H. & Morteza pour, A. 2016. Identification of the ergonomic interventions goals from the viewpoint of ergonomics experts of Iran using fuzzy delphi method. *International Journal Of Occupational Hygiene* 14(63): 151-157.
- Buckle, P.W. & Devereux, J.J. 2002. The nature of work-related neck and upper limb musculoskeletal disorders. *Applied Ergonomics* 33:207-217.
- Colombini, D., and Occhipinti, E. 2006. Preventing Upper Limb Work-Related Musculoskeletal Disorders (UL-WMSDs): New Approaches in Job (re)design and Current Trends in Standardization. *Applied Ergonomics* 37:441-450.
- De Looze, M. P., Kuijt-Evers, L. F. M., & Van Dieën, J. 2003. Sitting comfort and discomfort and the relationships with objective measures. *Ergonomics* 46(10): 985-97.
- Fai, T.C., Delbressine, F. & Rauterberg, M. 2007. Vehicle seat design: State of the Art and Recent Development. *Proceedings World Engineering Congress*, 51-61.
- Graf, M., Guggenbuhl, U. & Krueger, H. 1995. An assessment of seated activity and postures at five workplaces. *International Journal of Industrial Ergonomics* 15:81-90.
- Richards, L.G. 1980. On the psychology of passenger comfort. *Human factors in Transport Research* 2:15-23.
- Shariat, A., Cleland, J. A., Danaee, M., Kargarfard, M., Moradi, V., & Bahri Mohd Tamrin, S. (2018). Relationships between Cornell Musculoskeletal Discomfort Questionnaire and Online Rapid Office Strain Assessment Questionnaire. *Iranian journal of public health*, 47(11), 1756-1762.
- Vergara, M. & Page, A. 2000. System to measure the use of the backrest in sitting-posture office tasks. *Applied Ergonomics* 31:247-254.
- Vink, P., & Hallbeck, S. 2012. Editorial: comfort and discomfort studies demonstrate the need for a new model. *Applied Ergonomics* 43(2): 271-276.
- Vink, P., Jong, A.D. & Koningsveld, E. 2005. Making money with participatory ergonomics. *Human Factors in Organizational Design and Management VIII*, IEA Press, Santa Monica: 443-448.

EXPERIENCE THE NATURE VIA SMART 'SEGAR AMAT' BRIDGE AT RECREATION PARK

Tan Vie Khuen

Faculty of Architecture and Ekistics, University Malaysia Kelantan,
Bachok Campus, 16300, Bachok, Kelantan, Malaysia
tanviekhuen@gmail.com

Wan Azlina Wan Ismail, Ramly Hasan, Nor Diana Aziz, Mohammed Fadzli Maharimi

Faculty of Architecture and Ekistics, University Malaysia Kelantan,
Bachok Campus, 16300, Bachok, Kelantan
azlina@umk.edu.my , ramly.h@umk.edu.my , dianaaziz@uitm.edu.my , fadzli.m@umk.edu.my

Highlights: Bridge is a structure that covers a depression or obstacle to carry a route or roadway. 'Segar Amat' bridge is redesign from the existing bridge in river Segamat recreational park. This bridge can let the users to experience the nature and enjoy the view in the lake. And also provide the innovation technology to give the convenience to the users and also to reduce the heat at the surrounding area. This bridge is located in main entrance and make the connection form the residential area to the recreational park and this segar amat can bring the welcoming sense to the users. Segar amat bridge will become the landmark at the recreational park.

Key words: *Bridge, Creativity and Innovation, Technology, Irrigation System*

Introduction

Segar amat bridge is located in river Segamat recreational park, this bridge is the connection of the entrance to the park. Beside the bridge have purposed the landscape planting that can let the users to experience the nature and also to enjoy the scenery of the lake while pass by the bridge. Irrigation system have been purposed to watering the planting and it also can reduce the heat for surrounding area. The main material of the bridge is used the material wood to create the sense of nature. Technology that applied in the bridge are the lighting technology and the projector digital technology. The techniques and strategies for creating and storing light are known as lighting technology. Optical and visual technology are more closely tied to manipulating (bending reflecting) light. Although the storage of energy for the formation of light is not always strictly included in lighting, it is commonly included. For instance, in the use of torches using batteries. The lighting technology applied to the bridge and give the main attraction to the bridge at night. Projector digital technology, also known as a digital projection display system, is a computer display that displays an expanded image on a movie screen. Presentations frequently employ such technologies. The projector digital technology used as the wayfinding system for the park.

The shape of the bridge is based by the form of tunnel and want to give users sense of escape which they will feel when they pass by the bridge like they escape form the busy city life to the park. The material of the bridge mainly is the Chengal wood. The Neobalanocarpus tree, which is predominantly found in Malaysia, produces chengal wood. Advantages of the mature Chengal wood is more durable than the young Chengal wood. So, it's better to choose mature Chengal wood. The Chengal wood is primarily used outside on patios and balconies for decoration. Termite, wear, and tear resistance are all features of Chengal wood. Chengal is a versatile wood that may be used in both wet and dry environments. And by using the wood material to create the sense of natural.

Advantages of the bridge which can let the users enjoy and view the scenery of the lake and the bridge also can become the connection between the park and the residential area. By purposed the bridge, neighbourhood residential area can easy to access to the park and give the convenience to the users. Another advantages is they are quite frequent because they are simple to construct and affordable in comparison to other bridge types. For the safety issues of the bridge have been purposed the net beside the bridge. Segar amat bridge also can help to decrease the costing for the human resources because that the irrigation system will watering itself automatic and the water will used the lake water. By purposed net and the shrub planting at beside of the bridge which can decrease the dangerous of users at the park by pass the bridge. At the two side of the bridge have been purposed the qr code, users can scan the qr code and can explore the information of the bridge and this can help the users in park to explore their knowledge. This product can suggestion to the local authority by purpose the bridge with the experience nature and the irrigation system in the park with the lake or bridge. The bridge purposed with the technology and the innovation, this will give the attraction to the communities and will attract the users come to the park to increase the probability to the local authority.

Segar amat bridge is the connectivity for the residential area to recreational park and this bridge have been purposed the natural planting which want to create the sense of nature and give the users can feel the escape for the busy city life while pass by the bridge. And the innovation and the technology have been applied, it will be definitely be one of the landmarks here.

Acknowledgement

My gratitude and thanks go to my lecturer Dr Ramly bin Hasan. Without his kind direction and proper guidance this study would have been a little success. In every phase of the project his supervision and guidance shaped this report to be completed perfectly.

References

- Twiss, B. (1989). Goodridge M., Managing Technology for Competitive Advantage: Integrating Technological and Organisational Development.
- Rosenberg, N., & Frischtak, C. (1985). International Technology Transfer: Concepts, Measures And Comparisons. New York: Praeger.
- Burgelman, R. A., Maidique, M. A., & Wheelwright, S. C. (1996). Strategic Management of Technology and Innovation. (2nd Ed.). Chicago: I. L. Irwin.
- DOE. March 2012. Buildings Energy Data Book: 5.6 Lighting, 5.6.4 2010 Total Lighting Technology Electricity Consumption, by Sector.
- Mary F. Rice (2019). Projections of Identity: How Technological Devices Become Us and Why It Matters in ELA Teacher Education.
- Balasubramanian (2017). Bridges and their Types (University of Mysore).

REMEMBERING CULTURE ACTIVITY FOR THE USER AT PANTAI SRI TUJUH, TUMPAT

Nik Nabila Nik Mat

Faculty of Architecture and Ekistics, University Malaysia Kelantan,
Bachok Campus, 16300, Bachok, Kelantan, Malaysia
nabilawani7@gmail.com

Wan Azlina Wan Ismail, Ramly Hasan, Nor Diana Aziz, Mohammed Fadzli Maharimi

Faculty of Architecture and Ekistics, University Malaysia Kelantan,
Bachok Campus, 16300, Bachok, Kelantan
azlina@umk.edu.my, ramly.h@umk.edu.my, dianaaziz@uitm.edu.my, fadzli.m@umk.edu.my

Highlights: This research intends to examine the factors that influence creative students' level of creativity and innovation in the growth of entrepreneurship. Playing wau, also known as kite, was originally popular in the country, but it is now popular among many people, even those who live in cities. Aspects of Malay local culture can be found in this game. This can be seen in the shape and design of the wau's pattern. The results reveal that independent variables partially influence the invention of product cultural and creative products in Kelantan, utilising interview methodology with owners of local community creative wau bulan and perahu payang painting, bamboo and wood in region Kelantan, emphasising that in order to generate new goods with additional value. It will become a one-of-a-kind product that will symbolise the culture of the area and will also attract people.

Key words: *Product innovation, design creativity, innovation and creativity, traditional game, marketing, design management.*

Introduction

Innovation design is about finding solutions, and the companies that offer the best solutions to consumer problems are much more likely to succeed. Design innovation from perahu payang is one of the process of identifying, pinpointing, and understanding the needs of the user or visitor. Novelty product sri payang is an idea that is made from payang boat and bench into a unique hardscape and can attract visitor. Function of this product suitable for all ages and make it an attraction for visitors and locals, reminiscent of the culture of Sri tujuh Beach, become a unique sculpture from the processing of payang boats. This innovation and creativity also function as a hardscape to show the history of existence of the muzium wau and also the festival wau at pantai sri tujuh. This sri wau also to remembrance the cultural of sri tujuh. Kites come in a variety of shapes and sizes, with names like moon kites. They are, however, particularly the Malays. The traditional larat cloud pattern will adorn the numerous kites made, which will be dyed in a variety of hues. Kites are made from a variety of materials, including toys, handicrafts, and wall decorations.

Sri payang is one of the constructions that has been embellished with payang boats and chairs to create a one-of-a-kind structure that can draw visitors to Sri Tujuh Beach. Furthermore, it has the potential to promote the product and the location indirectly. The presence of this structure can serve as a reminder of the area's culture. Sri payang serves two purposes: it can be used as a seat, but it can also be utilised as a planter box on the left and right sides of the boat. With the colour of the shrub, it evokes the area's liveliness and sri payang. The only material utilised is cengal wood, which is a type of wood. Whereas cengal wood is sturdy and rugged, it is also resistant to termite attack. Cengal wood is another commonly used material for outdoor furniture. Cengal is one of the world's toughest woods, and it's made from Cengal trees. It's classified as timber, and it's hard, dense, durable, pricey, and of the best quality. In the establishment of a recreational area, places play a vital role in guaranteeing the landscape's sustainability. The implementation of well-planned landscape planning can improve the quality of recreational spaces while also preserving societal harmony. Furthermore, maintenance is essential to ensure that the facilities given are long-lasting, always safe, and attract customers.

It can be deduced from the findings of this study that the natural components in Pantai Sri Tujuh are used to determine the level of visitor happiness. Beautiful aspects, cooling elements, and visitors' appreciation of the place are among the variables that affect or attract tourists to the recreational area. Values and benefits from areas such as serenity, calm, stress alleviation, and approach to nature are also related with their sense of satisfaction, in addition to physical qualities. Other aspects of the area's maintenance and management also have an impact on visitor pleasure. Clearly, a dangerous environment will have a detrimental influence on visitor satisfaction. It is envisaged that the neglected natural features in this study region would be upgraded as a result of our research, and that visitor pleasure will improve in the future.

Acknowledgement

According to the findings of this study, the creation of innovative items such as the unique payang bench and signs wau requires attention to client needs based on experience, as well as the improvement of creativity and innovation in some areas. this product can be market because they have characteristic unique traditional kelantan and might be potential place to attract people. The combination of these two aspects results in an environmentally friendly recreation space. Both of these sorts of sceneries are vital in the construction of a landscape that is neither too rugged nor too soft. As a result, both types of landscaping will be used to create visually appealing surroundings. In addition to enhancing the structure of Sri Payang, systematic landscape planning and management can increase the qualitative appearance and life duration of a recreational space. Landscape planning and management that is methodical and precise can help to decrease environmental damage, increase quality of life, user experience, and landscape attractiveness.

References

- Freeman, Chris, 1994, 'Innovation and Growth', in Mark Dodgson and Roy Rothwell (eds.), *The Handbook of Industrial Innovation*, Aldershot: Elgar, pp. 78-93.
- Acs, Zoltan J. and David B. Audretsch (eds.), 1990, *The Economics of Small Firms*, Dordrecht: Kluwer.
- Arrow, Kenneth J., 1983, 'Innovation in Large and Small Firms' in Ronen, Joshua (ed.), *Entrepreneurship*, Lexington MA: Heath, pp. 15-28.

DEVELOPING ICONIC LANDMARK OF GREEN CURTAIN TOWER AT KOLAM HIJAU COMMUNITY PARK

Raja Faerull Asraf Raja Alim

University Malaysia Kelantan, Bachok, Malaysia
kualaempat@gmail.com

Ramly Hasan, Wan Azlina Wan Ismail, Muhamad Hilmi Mohamad @ Masri, Nor Diana Aziz

University Malaysia Kelantan, Bachok, Malaysia
ramlyhasan80@yahoo.com, azlina@umk.edu.my, muhamadhilmi@uitm.edu.my, dianaaziz@uitm.edu.my

Highlights: Public park development requires something that has a wow factor to encourage visitors to the park for recreation and recreation, especially if located in a rural area. It is not limited to just recreational activities because the rural areas still have a lot of open space for residents to exercise with the work they do is not limited to parks. So, something that can catch their attention needs to be created in order to take them to the park. Green Curtain tower is built to attract local visitors and tourists with its unique architecture and various functions that have been innovated, it is a modern structure in the village can indirectly become an iconic symbol not only in the Kolam Hijau community park but for the surrounding area.

Key words: *green curtain tower, vertical planting, wind musical, structure, guidelines, collaboration*

Introduction

Green curtain tower is an observation tower built by the pond to see the scenery around the Kolam Hijau Community Park, kampung Saujana, Setiu, Terengganu. Deliberately built a modern design structure in the rural area, a new sensation of the Kolam Hijau Community Park indirectly promotes the park for locals to live a healthy lifestyle, it is the most prominent object in the surrounding area and serves as an iconic landmark. The structure is decorated with a vertical landscape to ease the hard construction so that it is more green building and is equipped with wind power musical on some floors to hear the sound of the wind according to height.

Structure with a height of 15 meters high and a maximum diameter of 7 meters, principally consists of two collaborating systems viz steel structures combined with a tensile cable structure system for vertical planting it is also equipped with CCTV and lights that use solar systems

The development of the concept was inspired by the dominant plant species on the site namely gelam tree (*Melaleuca cajuputi*). The gelam trunk as the main structure, the layered gelam tree bark as a spiral-shaped platform and ladder and the Chemar Hantu plant (*Cassytha electormis*) which is a creeping tree represent tensile cable and vertical planting, Chemar Hantu is a parasitic plant and an interesting relationship interest has matured Bunga Telang (*Clitoria ternatea*) and Curtain Plants (*Vernonia elaeagnifolia*) were chosen because they are hardy, attractive, sparse and suitable for vertical planting.

Guidelines have been made for the use of this green curtain tower because this structure is built high in public parks and open access with minimum supervision so the safety aspect is an important factor among them is open every day from 9am to 5.30 pm and on the day Friday from 12 am to 2.30 pm is temporarily closed, to ensure that when the structure is open for use the park area has many visitors, it is limited to children aged 5 years and above and children aged 12 years and below need to be supervised by parents or guard for safety purposes, carry capacity at a time is 12 people and visitors are prohibited from picking flowers and plants that is vertical planting and during rain and lightning are not allowed to use, all risks are the responsibility of visitors themselves, this rule statement is posted in the structure area

Green curtain tower can be focused on several parts for education 1. expose the rural community to the vertical landscape in terms of concept, plant selection, care and planting methods so that they are not left behind in the concept of green building 2. addition of wind music element with installation of weave trumpets in the structure of the building for the attraction to visitors to listen improved the voice of nature, users can hear the sound of the wind according to altitude 3. Construction of this structure serves as an observation tower built of stainless-steel structure in sandy areas and near the pond reveals to users about aspects of architecture and engineering. This green curtain tower structure is built with durability that is in an open area and close to the beach about 3 km using stainless steel, less maintenance with accessories such as lights and CCTV using solar system and open construction concept that is without roof and walls this encourages reduced watering for vertical planting only from rainwater and only manually if necessary because the planting is heat resistant and does not use much water and is suitable to grow in a limited cultivation medium. this structure also stands out and is an attraction for the Kolam Hijau Community Park

This commercialization product is managed by a Kolam Hijau of community members among local community to facilitate management by involving the local community, it can be accessed by scanning QR code provided in certain areas in collaboration with local authorities, Setiu Wetland, Agriculture Department and Ecosweed as NGO, accessible on web and social media they like Facebook and Instagram in addition to the brochure is also published on attractions and activities around the green curtain tower. The vertical landscape workshop is managed by the Department of Agriculture on a regular basis to promote green building to local communities and institutions while wind power musical can attract the attention of nearby school students as their outdoor classroom.

Acknowledgement

Special thanks to LAr. Dr Ramly bin Hasan, Dr Wan Azlina Wan Ismail, Dr Muhammad Hilmi and Dr Nor Diana for guiding me to complete my innovation project to succeed on their patience and guidance. In particular, I would like to thank a few friends who provided guidance in providing detailed construction input to the result of this creative idea. I was able to achieve this innovative design project.

References

- Adhalina, N. (2011). The Different Language Style and Language Function Between Students and Teachers in Updating Their Status In Facebook Webpage (A Case Study of the Topic National Final Examination 2011)(Doctoral dissertation, University of Diponegoro).
- Alessandra, A. J., O'Connor, M. J., & Van Dyke, J. (1994). People Smarts: Bending the Golden Rule to Give Others what They Want. Pfeiffer.

ADAPTIVE PRAYER WEAR FOR IMMOBILE MUSLIM WOMEN

Sarah Wahida binti Hasbullah

Universiti Malaysia Kelantan, Bachok, Kelantan
sarahwahida@umk.edu.my

Siti Nurul Diana binti Sukri, Mohd Zaimuddin bin Mohd Zain, Hana Yazmeen binti Hapiz, Azlin Sharina binti Abdul Latef, Mohd Hafiz bin Drahman, Nurul Syahida binti Mat Hussin

Universiti Malaysia Kelantan, Bachok, Kelantan
nuruldiana@umk.edu.my, zaimmudin@umk.edu.my, hana@umk.edu.my, azlinsharina@umk.edu.my,
hafiz.d@umk.edu.my, syahida.mh@umk.edu.my

Highlights: Muslim women need to cover their aurah during prayer. This research will focus on creating adaptive women clothing coverings to ease disabled people in performing their prayer. The particular focus is on women who cannot walk or stand but can move the upper parts of the body, which includes the area from the stomach, arms and head. The clothing covering will focus on women who prays while sitting on a chair and ables to move her hand for takbir, ruku and sujood freely. For this research, one elderly of 98 years of age old is the studied subject. The patient is immobile and needs assistance with wearing her prayer clothes.

Key words: Muslim, Prayer Clothing, Adaptive Wear, Disabled.

Introduction

Most of us don't think a lot about getting dressed, but the special needs are trained to improvise. This research looks into immobile patients who are unable to move from the hip and below. The objectives are to allow the carer and the special needs in putting on their prayer attire and for the special needs to be able to perform their prayer in comfort and ease. The goal here is to create adaptive prayer wear that allows an easy process between the carer and the wearer. The research has come up with a solution of making adaptive wear that resembles the actual 'telekung' but with a few adjustments to fit the needs better.

Content

Research on adaptive clothing has been studied extensively. These studies are in demand as disabled users always want products to cater for their lifestyle. The stages of innovation on adaptive clothing includes ready-to-wear clothing, followed by innovation focusing on the various needs of the disabled design. The focusing innovation is made to cater to the small population as the product created was based on a particular situation of the disabled user. The latest research involvement regarding adaptive clothing penetrated the fashion industries, where the adaptive clothing lines were mass-produced for commercialization. The primary function of adaptive clothing is to address the function needed while being aesthetically pleasing to the eye. It should help the lifestyle and, simultaneously, functional and fashionable while hiding the hidden look of it being an item of adaptive clothing (Kosinski, Kelsey, Orzada, & Kim, 2018). The idea of adaptive clothing should meet everyone, not just for the disabilities (McFarland, 2016). The adaptive clothing design should address problem-solving needs, considering empathy and human-centred design to find solutions.

Muslim women who are sane and pubescent are obligated to pray five ritual prayers a day while covering their aurah. The act of covering is one of the prerequisites of salah. The coverings should be the entire body, except for her hand and the face area. (Quran, An-Nur 24:31). This covering can be a simple act for an abled person, and however, it can be a struggle with a disabled or immobile person. In this research context, a carer or helper must help lift the subject and dress the subject before performing her prayer. This research will consider facilitating the subject (the disabled person) and the helper. As the subject is immobile, the helper will do most of the covering or clothing processes while the subject will remain seated on a chair. There will be two parts of the adaptive clothing, as follows from the existing praying clothes in Malaysia. The difference will be on the cutting, the shape of the clothing, the placement of rubber and Velcro for easy assemble and disassemble. Among the benefit of this innovation is that it helps ease the helper with covering their subject, and it will also aid with the speed of the assemble. The carefully planned design and adoptive covering will be placed on a subject with ease, and the fashion detailing adds the added artistic value.

This study uses phenomenology with in-depth interviews. This research, which explores experience, was performed with qualitative research. The research instruments included: (a) researchers; (b) voice recorder; (c) interview guide; (d) researcher notes. During the interview, the researcher has aided the participants to wear prayer clothing before and after prayers.

The lead researcher has been living with her great grandmother for over five years of being immobile. The five years of experience has created a need for exploring different clothing styles and fashion for the prayer needs of an immobile person. Mass production in adaptive clothes are a trend today (Diament, 2016). With this invention, mass production is a possibility as the design created is flexible in sizing, and it should be able to help helpers and users with the same disability.

Acknowledgement

We are grateful to the grandmother of 98 years old Maimunah binti Ismail, for willingly and cooperatively be the subject matter for this adaptive prayer wear study, and a special thanks to Che Halimah binti Ali for voluntarily become an actress for the video shoot.

References

- Kosinski, Kelsey, Orzada, B., & Kim, H.-S. (2018). *Commercialization of Adaptive Clothing: Toward a Movement of Inclusive Design*. 12, 107. Retrieved from https://lib.dr.iastate.edu/cqi/viewcontent.cgi?article=3378&context=itaa_proceedings
- Hyun-Shin Na (2007). *Adaptive clothing Design for the Individuals with Special Needs : Journal of the Korean Society of Clothing and Textiles*. 31(6).
- Stokes, B. & Black, C. (2012). Application of the functional, expressive and aesthetic consumer needs model: assessing the clothing needs of adolescent girls with disabilities. *International Journal of Fashion Design, Technology and Education*, 5(3), 179-186. DOI: 10.1080/17543266.2012.700735
- Lamb, J. M. (2001). Disability and the social importance of appearance. *Clothing and Textiles Research Journal*, 19(3), 134 – 143. DOI: 10.1177/0887302X0101900304
- Suri, Prerna. (2016). *CLOTHING NEEDS ASSESSMENT FOR WHEELCHAIR USERS*. Retrieved from https://etd.ohiolink.edu/apexprod/rws_etd/send_file/send?accession=kent1470244671&disposition=inline
- Buck & Buck. (2015). Adaptive Clothing Guide. Retrieved from <http://www.buckandbuck.com/adaptive-clothing-guide/adaptive-clothing.html>
- McFarland, F. (2016, December 20). White House Disability and Inclusive Technology Summit, American Association of People with Disabilities. Retrieved from <https://www.aapd.com/white-house-disability-inclusive-technology-summit/>
- Diament, M. (2016). Tommy Hilfiger Debuts Adaptive Clothing Line Retrieved from <https://www.disabilitycoop.com/2016/02/23/tommy-hilfiger-adaptive/21949/>

OMNI: TOOTHBRUSH DESIGN FOR DOWN SYNDROME CHILDREN

Hana Hapiz

Universiti Malaysia Kelantan, Bachok, Kelantan
hana@umk.edu.my

Yuhanis Ibrahim, Sarah Wahida Hasbullah, Azlin Sharina Abdul Latef, Ainul Wahida Radzuan, Suraya Sukri, Mohd Zaimmudin Mohd Zain, Nuzul Hakimi Muhammad

Universiti Malaysia Kelantan, Bachok, Kelantan
yuhanisibrahim@umk.edu.my, sarahwahida@umk.edu.my, azlinsharina@umk.edu.my, ainul@umk.edu.my,
suraya@umk.edu.my, zaimmudin@umk.edu.my, nuzulhaqimi@umk.edu.my

Highlights: OMNI aims to make brushing teeth for children with Down Syndrome easier and convenient. Relying on all rounded soft silicone bristles, OMNI is made from medical-grade silicone and last a year. Soft silicone protects against over-brushing, preventing gum recession and damage to tooth enamel. Children with Down syndrome may have large tongues, or they may have an average size tongue and a small upper jaw that makes their tongue too large for their mouth. Thus, OMNI's sleek head facilitates the brushing easier and prevent gag reflex. OMNI does not require a lot of agility, strength and control of the user's arms and hands, and the bulky and good grip features of the body facilitate the brushing routine.

Key words: *Special Design, Toothbrush Design, Down Syndrome, Inclusive Design*

Introduction

The World Health Organization has listed Down syndrome as one of the most common serious congenital disorders worldwide, and increased research and care are focusing on this condition (WHO,2010). However, most studies of Down syndrome are performed in high-income countries with good resources. Minimal data are available on the survival of children with Down syndrome from low and middle-income countries. Down syndrome, a common genetic disorder, ranges in severity and is usually associated with medical and physical problems. For example, children with Down syndrome may experience more dental problems due to medications, low muscle tone, periodontal disease, trauma and injury to the mouth, mouth breathing, diet, and difficulty brushing. Periodontal disease is the most significant oral health problem in people with Down syndrome. Children experience rapid, destructive periodontal disease. Consequently, large numbers of them lose their permanent anterior teeth in their early teens. Contributing factors include poor oral hygiene, malocclusion, bruxism, conical-shaped tooth roots, and abnormal host response because of a compromised immune system. Some patients benefit from the daily use of an antimicrobial agent such as chlorhexidine.

Literature Review

Control of plaque and debris is essential for the prevention of inflammatory periodontal diseases and dental caries because plaque is the primary factor in the introduction and development of both infection-oriented diseases for children with Down Syndrome. Plaque removal with a toothbrush is the most frequently used method of oral hygiene. According to Hayaki et al. (2014), powered toothbrushes were developed beginning in the 1960s and are now widely used in developed countries. The bristles of a toothbrush should be able to reach and clean efficiently most areas of the mouth, and recently the design of both manual and powered toothbrushes has focused on the ability to reach and clean tooth surfaces. In a study conducted by Robertson and Wade (1972), they showed that subjects cleaned significantly better with medium and hard brushes than with a soft-bristled brush. Berdon et al. (1974) found that a toothbrush with 0.18 mm diameter filaments was significantly less effective in cleaning than were five brushes with larger diameter filaments from the same manufacturer. Gibson and Wade (1977) observed that a toothbrush with 0.2 mm diameter filaments tended to clean the marginal gingiva more effectively than another with 0.18 mm diameter filaments. In a crossover study, Vowles and Wade (1977) tested the differences between 0.13 mm and 0.28 mm filament diameters and found that plaque removal was significantly better with the thicker filaments when used with the roll technique for brushing the facial and interproximal areas. It appears, therefore, that filaments must have a degree of stiffness to dislodge plaque deposits.

Designs are based on the premise that most persons in any population use a simple horizontal brushing action. Over time, the design of the brush head has evolved and multiple tufts of bristles, sometimes angled in different directions, are now used. Today, prospective users can readily find a toothbrush with a handle size appropriate to their hand size, and much emphasis has been placed on new ergonomic designs (Van der Weijden & Hioe, 2005). Toothbrush manufacturers have made great effort in considering many different aspects when designing new models to meet the challenge of enhancing plaque biofilm removal through improved tooth brushing efficacy.

Due to manual toothbrushes' limitations, the powered toothbrushes were designed with various technologically advanced movements like side to side, circular, rotational oscillation, counter oscillation, ultrasonic vibration, and sonic action to improve oral hygiene and health care (Terezhalmay, 1994; Van der Wijden et al., 1998). These brushes were shown to be efficient to a certain extent (Goyal et al., 2009); however, they could not fulfil all demands, especially for the people with limited dexterity who required caregivers for their routine oral hygiene tasks (Tesini & Fenton, 1994). Due to these limitations, automated toothbrushes have emerged to improve dental plaque removal ability as well as usability. Automation was introduced to help the users perform the toothbrushing action without or with less skill. One of these recently introduced toothbrushes is a new U-shaped, fully automatic electric toothbrush with silicone bristles, which was introduced recently claiming that it can simultaneously clean both the maxilla and the mandible time.

A study by Saghiri et al. (2020) found that toothbrushes that can establish better and intimate contact with tooth surfaces and perform the brushing action with scrubbing motion have better dental plaque removal ability. Other features, such as ultrasonic or sonic actions, can improve the plaque removal ability of toothbrushes. The automated toothbrushes that can have better adaptation with tooth surfaces can be regarded as good toothbrushes for dental plaque removal. However, these toothbrushes are still new in concept. They require more preclinical and clinical studies to be established as useful oral healthcare devices compared to the currently used power toothbrushes. However, the use of new materials such as for the bristles such as bamboo and silicone are believed revolutionary as they contribute to the bacteria repellent properties of the toothbrush (Zhang & Zhang, 2018).

In the vernacular of design, designers attempt to solve special design needs by using inclusive design approach. The British Standards Institute (2005) defines inclusive design as: 'The design of mainstream products and/or services that are accessible to, and usable by, as many people as reasonably possible ... without the need for special adaptation or specialised design.' Inclusive design does not suggest that it is always possible (or appropriate) to design one product to address the needs of the entire population. Instead, inclusive design guides an appropriate design response to diversity in the population through:

- Developing a family of products and derivatives to provide the best possible coverage of the population.
- Ensuring that each individual product has clear and distinct target users.
- Reducing the level of ability required to use each product, to improve the user experience for a broad range of customers, in a variety of situations.

Product Development

OMNI are designed using inclusive design approach whereby, children with Down Syndrome as main actor, the central focus of the design criteria.



Figure 1: OMNI's Design Criteria And Specification

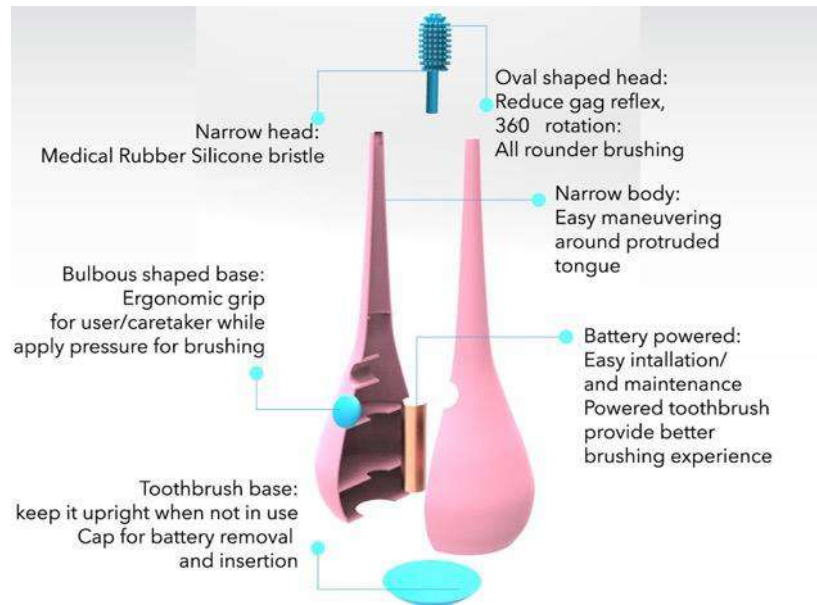

Figure 2: OMNI's Design Criteria And Specification

Product Novelty

The advancement of material technology has led to many great discoveries, among them is silicone rubber material. OMNI highlights the importance of silicone as the toothbrush bristle as its anti-bacterial feature will repel and minimise bacterial infection on the gums of the users. OMNI's narrow head enables the bristle to reach user's smaller teeth besides minimising the gag reflex by the users, due to their large tongue. It is believed that periodontal diseases can be avoided if toothbrushing routine starts at the earliest stage of tooth eruption. OMNI does not enable gag reflex and brushing teeth routine will not be as daunting as it used to be as the silicone spherical head will make brushing easy, prevent over brushing and prevent tartar build ups and cavities. OMNI does not require a lot of agility, strength and control of the user's arms and hands, and the bulky and good grip features of the body facilitate the use of the toothbrush. OMNI's innovative way of brushing teeth will contribute a better new painless brushing habit for children with Down Syndrome.

References

- Gibson, J. A., & Wade, A. B. (1977). Plaque Removal By The Bass And Roll Brushing Techniques. *Journal Of Periodontology*, 48(8), 456-459.
- Goyal, C. R., Qaqish, J., He, T., Grender, J., Walters, P., & Biesbrock, A. R. (2009). A Randomized 12-Week Study To Compare The Gingivitis And Plaque Reduction Benefits Of A Rotation-Oscillation Power Toothbrush And A Sonic Power Toothbrush. *Journal Of Clinical Dentistry*, 20(3), 93.
- Hayasaki, H., Saitoh, I., Nakakura-Ohshima, K., Hanasaki, M., Nogami, Y., Nakajima, T., ... & Yamasaki, Y. (2014). Tooth Brushing For Oral Prophylaxis. *Japanese Dental Science Review*, 50(3), 69-77.
- Kiche, M. S., Fayle, S. A., & Curzon, M. E. J. (2002). A Clinical Trial Comparing The Effectiveness Of A Three-Headed Versus A Conventional Toothbrush For Oral Hygiene In Children. *European Journal Of Paediatric Dentistry*, 3, 33-38.
- Robertson, N. A. E., & Wade, A. B. (1972). Effect Of Filament Diameter And Density In Toothbrushes. *Journal Of Periodontal Research*, 7(4), 346-350.
- Saghiri, M. A., Saghiri, A. M., Asatourian, A., & Nath, D. Dental Plaque Removal Ability Of Different Power Toothbrushes: A Preliminary Study Of A Novel Automated Toothbrush. *Medical Devices & Sensors*, E10157.
- Terezhalmay, G. T. (1994). Clinical Evaluation Of The Efficacy And Safety Of The Ultra-Sonex[®] Ultrasonic Toothbrush; A 30-Day Study. *Compend. Contin. Educ. Dent.*, 15, 866-874.
- Van Der Weijden, G. A., Timmerman, M. F., Danser, M. M., & Van Der Velden, U. (1998). Relationship Between The Plaque Removal Efficacy Of A Manual Toothbrush And Brushing Force. *Journal Of Clinical Periodontology*, 25(5), 413-416.
- Van Der Weijden, G. A., & Hioe, K. P. K. (2005). A Systematic Review Of The Effectiveness Of Self-Performed Mechanical Plaque Removal In Adults With Gingivitis Using A Manual Toothbrush. *Journal Of Clinical Periodontology*, 32, 214-228.
- Vowles, A. D., & Wade, A. B. (1977). Importance Of Filament Diameter When Using Bass Brushing Technique. *Journal Of Periodontology*, 48(8), 460-463.
- World Health Organization. (2010). *World Health Statistics 2010*. World Health Organization.
- Zhang, Y., & Zhang, X. (2018). Clinical Evaluation Of Toothbrushing Effects Of The Manual Toothbrush With The Bristles Made Of 3 Different Materials. *Journal Of Practical Stomatology*, 34(1), 117-120.

**GAPURA:
APPLICATION OF 3D TECHNOLOGY VISUALISATION IN CONSERVING HERITAGE BUILDING OF
ISTANA BALAI BESAR**

Siti Aisyah Muhammad

Faculty of Architecture and Ekistics, Universiti Malaysia Kelantan, 16300 Bachok, Kelantan, Malaysia
aisyah@umk.edu.my

Azli Bin Abdullah, Yasmin Binti Mohd Faudzi, Ahmad Nizam Aiman Bin Mohd Pauzi, Normaisarah Binti Mohd Rosdi, and Muhammad Arib Muzakkir Bin Mohd Salleh

Faculty of Architecture and Ekistics, Universiti Malaysia Kelantan, 16300 Bachok, Kelantan, Malaysia
azli.ab@umk.edu.my, yasmin.mf@umk.edu.my, nizampauzi@gmail.com, mai981130@gmail.com,
aribmuzakkir.msalleh@gmail.com

Highlights: This study was aimed to introduce a new efficient way that can utilize for the future in conserving and ensuring heritage building appreciation. This project has selected an iconic heritage building that had been built over 100 years ago in Kelantan namely Istana Balai Besar, Jalan Pintu Pong, Kota Bharu, Kelantan. The method applied for this project by using software that can produce 3d visualization; 3d Sketch-Up model. The result was examined to design a remarkable 3d model of Istana Balai Besar similar to the exact building. This 3d visualization project group presented as GAPURA will be able to deliver various benefits for instance, as a reference for future research regarding the heritage buildings, virtual tourism such as today's current pandemic situation, and for the educational purpose about the architectural heritage of Malaysia.

Keywords: GAPURA, 3d technology visualization, Sketch-Up, pandemic, Istana Balai Besar, virtual tourism

Introduction

The name GAPURA is brought to a meaning of an old Malay language, literally means 'a gate'. It also gives a means as knowledge of institutions and organizations who struggle to build and develop information literary sciences evolve not only through knowledge but also through private ideas namely GAPURA. This project represents the benefits of using 3d technology visualization to conserve a heritage building, Istana Balai Besar. In accordance with the conservation principle, the practice of building conservation should maintain as much as possible the original building structure and fabric (Harun, 2017). UNESCO's Convention Concerning the Protection of the World Cultural and Natural Heritage (1972) has defined cultural heritage by the following classifications:

1. Monuments: architectural works, works of monumental sculpture and painting, elements or structure of an archeological nature, inscriptions, cave dwellings, and combinations of features, which are outstanding universal value from the point of view of history, art or science
2. Groups of buildings: groups of separate or connected buildings which, because of their architecture, their homogeneity or their place in the landscape, are of outstanding universal value from the point of view of history, art or science.
3. Sites: works of man or the combined works of nature and of man, and areas including archeological sites which are of outstanding universal value from the historical, aesthetic, ethnological or anthropological points of view

Thus, it is part of the community services and cultural heritage awareness that we come out with this project and team namely GAPURA to be part of the conservation participation of heritage building focusing Kelantan Darul Naim. Using 3d technology visualization, we will restore the architectural design's original construction. 3D visualization refers to the process where graphical content is created using 3D software. Similar terms include 3D rendering, excellent computer-generated imagery (CGI), 3D graphics, and so on. Over recent years 3d visualization has gained great popularity and evolved into one of the most essential methods to producing high-quality digital content. Numerous industries ranging from films, games, engineering, architecture, hospitals, and manufacture are taking advantage of such technology and this becomes our ambition to contribute to technological visualization in architecture. Istana Balai Besar is a ceremonial palace for Kelantan royalty that was built in 1884 and restricted to the public. The opportunity we have and permissible project of 3d modeling of Istana Balai Besar will be a benchmark of future virtual tourism of Kelantan royal heritage buildings as well.

Design development

Conventionally, people sketch and draw an old building to get a description of the building and doing conservation basically through measured drawings and dilapidation study. Nowadays, with technological development, we grab the opportunity to utilize the ways to conserve heritage building using 3d modeling. Nevertheless, the current pandemic situation makes us limited our movement, and surprisingly people are getting excited about exploring techniques such as online tours, virtual tourism and webinar. Thus, we proposed a new 3d technology visualization on Istana Balai Besar that will show the real site interior and exterior of Istana Balai Besar and it is aimed to expose more people to this heritage building. The term 'stay at home' is now part of the everyday vocabulary in times of the global Covid-19 pandemic outbreak. How the pandemic has completely reformed our activities, especially for people who love traveling and heritage building, has created new opportunities for a creative renaissance in commercial technology. Thus, it resulted in the objectives of this invention as followed:

1. To expose people on heritage building and appreciated architecture heritage
2. To attract people of using digital tourism
3. To be as a reference for future studies
4. To deliver the virtual reality of Istana Balai Besar

Background of Innovation

This project was initiated to produce a 3d visualization on Istana Balai Besar with 3D architectural models in 3D modeling software namely Sketch-Up. These models can be much more informative than 2D models, as they can show viewers the texture, shape, and size of potential buildings. The 3D modeling process produces a digital object capable of being fully animated such as a real physical building. It is suitable to use for conserving a heritage building especially the building that has been demolished and keep it in digital ways. The usage of technology incorporates the idea of using software to produce virtual reality whether interior or exterior of Istana Balai Besar itself for various usage it can be a reference to researchers that are interested to conduct on certain detail especially at Istana Balai Besar. Therefore, users have the freedom to study and get a clear view of Istana Balai Besar and get the experience to feel the space and how it is related to its surroundings. This new invention of 3d technology visualization draws upon its aims to contribute to the appreciation of architectural heritage. The following Figures show the development of 3d modeling of Istana Balai Besar using Sketch-Up.

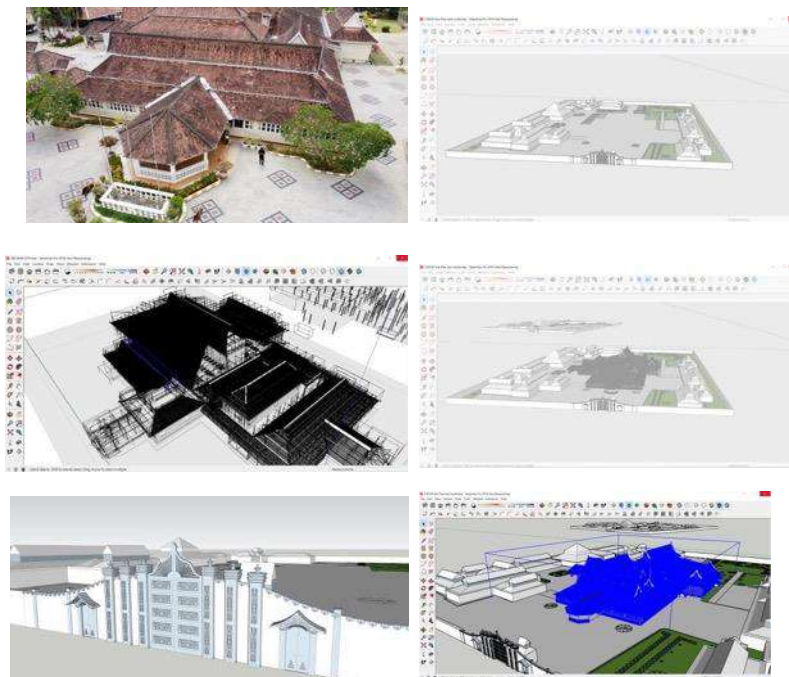

Figure 1 : The development of 3d modelling of Istana Balai Besar

Advantages of innovation

3d technology visualization contributes to society and country in several ways, such can be utilized to more clearly represents projects to other designers, builders, and clients although such as architectural construction, finishing design, space organization and building systems. On top of that, utilizing 3d technology visualization can assist the audience with better visualization of the Istana Balai Besar itself through exploring the animation at the exterior and interior of the palace. This 3d visualization is a valuable asset as it can save time and cost. From this 3d technology visualization also can be developed to augmented reality and virtual reality in the future.

Commercial values

3d technology visualization has strong potential in promoting the heritage tourism industry and virtual tourism parallel to the current pandemic situation and 4iR development. A 3D visualization is a great way to market a concept or project to the public besides gives them a view of what the building looks like. Figure 2 below shows the exact building of Istana Balai Besar (left) and the 3d model (right).

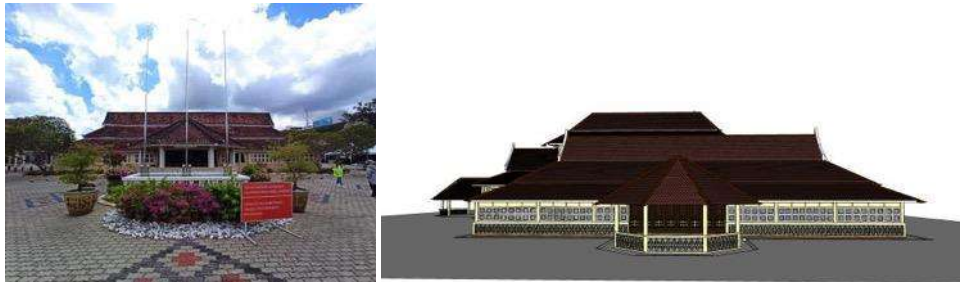

Figure 2: Comparison of the exact image of Istana Balai Besar (left) and 3d model of Istana Balai Besar (right)

Acknowledgment

We are grateful for the excellent appreciation to Pejabat Sultan Kelantan and all GAPURA members for their cooperation and contributions.

References

- ICOMOS Australia. (1981). Charter for the Conservation of Places of Cultural Significance (The Burra Charter), Australia ICOM OS Inc, Sydney
- Kerajaan Malaysia, (2008), Akta Warisan Kebangsaan 2005 (Akta 645)
- NARA Document on Authenticity (1994), NARA Conference on Authenticity, Japan. UNESCO, 1-6 Nov 1994
- Siti Norlizaiha Harun , (2011). Authenticity in conservation. [www.http// kota-city. Blogspot.com](http://kota-city.blogspot.com)
- Siti Norlizaiha Harun, (2011), Heritage Building Conservation in Malaysia: Experience and Challenges *Procedia Engineering* 20 (2011) 41 – 53 The 2nd International Building Control Conference 2011

FLUX: A MODULAR 3D PRINTED FURNITURE JOINERY SYSTEM

Muhamad Ezran Zainal Abdullah

Fakulti Teknologi Kreatif dan Warisan, Universiti Malaysia Kelantan, Kelantan, Malaysia ezran@umk.edu.my

Nor Hamizah Abdul Hamid¹, Jarfrulhizam Jaafar², Mohd Hilmi Harun², Siti Nurul Diana Sukri², Mohd Firuz Mohd Anwar², Darliana Mohamad², and Nooraziah Ahmad²

¹Fakulti Senibina dan Ekistik, Universiti Malaysia Kelantan, Kelantan, Malaysia

²Fakulti Teknologi Kreatif dan Warisan, Universiti Malaysia Kelantan, Kelantan, Malaysia

norhamizah@umk.edu.my, jarfrulhizam@umk.edu.my, hilmiharun@umk.edu.my, nuruldiana@umk.edu.my, firuz.ma@umk.edu.my, darliana.m@umk.edu.my, nooraziah@umk.edu.my

Highlights: FLUX is a Modular 3D printed furniture joinery system that simplifies the hassle of fabricating complex wood joinery, joinery on a 90-degree angle and flat-packed arrangement for storage & delivery purposes. It satisfies the exigencies of the current pandemic online platform demand while reducing the cost of fabricating and handling the furniture parts.

Keywords: Modular furniture, 3D printer, Furniture joinery system.

Introduction

The current pandemic situation has drastically changed how the consumerism cycle works. As a result, full setup furniture may become a burden in either the storage space needed by the fabricator or the fuss handling oversized items by the courier provider. Thus, FLUX is a new concept on how furniture should be designed and handled to ensure all unnecessary costs can be kept at bay.

Content

The Ergo-aesthetic framework (figure 1) work as a guideline to set a priority level on each aspect of the design. It helps all designers to eliminate unnecessary elements while designing and focusing on the priority aspect. The Ergo-aesthetic Framework has been explicitly organised towards the design assessment elements, i.e. design quality, behaviour and culture, and virtual assessment. This framework has shown the relationship between the ergonomic domain and the aesthetic domain, which share the same characteristic on each evaluation criteria (Muhamad Ezran & Khairul Aidil Azlin, 2018). For instance, value and theme in the aesthetic domain share the same assessment criterion of behaviour and culture with the user movement and human postures inside the ergonomic domain. Besides, the most prioritised element has been placed in a darker chromatic colour scheme.

A product for people with specific disabilities requires extra attention to their behavioural preferences. The design should be flexible enough to simulate the current situation and demand as the design is usually extraction of the users' life experiences (Bei & Yan, 2011). In other words, the designed item should be highly pliant towards the anthropometric and biomechanical character of the user to optimise the productivity (Afzan et al., 2012), as an uncomfortable design may lead to health implications (Agha & Alnahhal, 2012). Beyond functionality, with improvements in product development technologies, consumers are prepared to have exciting products that can give them greater satisfaction through product relationships (Yang et al., 2019). By applying the Ergo-Aesthetic framework in the design process, FLUX has tremendously improved the dynamic setup of the intended furniture configuration regarding assembling capabilities, compact packaging, design and shapes configuration, and flexibility on colour selection. FLUX joinery system improving the time needed to assemble a piece of furniture by 80% yet maintaining the sturdiness of the overall structure.

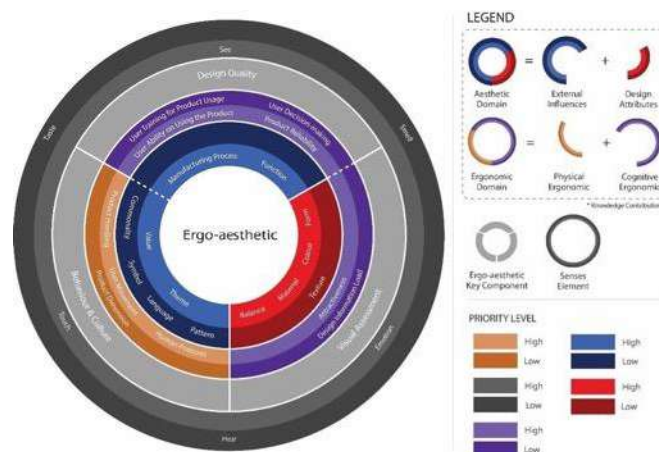

Figure 1: Ergo-aesthetic framework

The Ergo-aesthetic framework has become the philosophical basis for innovation, consisting of behaviour and culture, visual assessment, and design quality. Consumer and designer co-relationship has distinguished FLUX main specification, which are:

1. Easy to pack, deliver and assemble;
2. Reduce the complexity of the wood joinery fabrication and assembly process;
3. Universal joinery system which can suit with common joinery wood end.
4. Simplify the complexity in fabricating organic shapes in design.



Figure 2: Physical prototype of the FLUX assembly process

Figure 2 shows the FLUX 3D printed part, enabling the single sitter chair to be assembled using a cordless driller and screws. The joinery part also emphasises the colour contrast between the wood part and the printed part, which inherent in the Bauhaus philosophical direction. Figure 3 shows the overall setup for the single-seater chair.



Figure 3: Rendering illustration on FLUX application towards a single sitter sofa

Acknowledgement

This study was supported by Universiti Malaysia Kelantan through the Short-Term Research Grant Scheme (R/FUND/A0200/00782A/003/2020/00856).

References

- Afzan, Z. Z., Hadi, S. A., Shamsul, B. T., Zailina, H., Nada, I., & Rahmah, A. R. S. (2012). Mismatch between school furniture and anthropometric measures among primary school children in Mersing, Johor, Malaysia. *2012 Southeast Asian Network of Ergonomics Societies Conference: Ergonomics Innovations Leveraging User Experience and Sustainability, SEANES 2012*, 3–7. <https://doi.org/10.1109/SEANES.2012.6299557>
- Agha, S. R., & Alnahhal, M. J. (2012). Neural network and multiple linear regression to predict school children dimensions for ergonomic school furniture design. *Applied Ergonomics*, 43(6), 979–984. <https://doi.org/10.1016/j.apergo.2012.01.007>
- Bei, F., & Yan, Y. (2011). A perspective of novel design and creativity in the development of furniture. *IEEE*, 6–9.
- Muhamad Ezran, Z. A., & Khairul Aidil Azlin, A. R. (2018). Ergo-aesthetic approach through senses and behavioral assessment. *International Journal of Engineering & Technology*, 7(3.28), 1. <https://doi.org/10.14419/ijet.v7i3.28.20953>
- Yang, B., Liu, Y., Liang, Y., & Tang, M. (2019). Exploiting user experience from online customer reviews for product design. *International Journal of Information Management*, 46(May 2018), 173–186. <https://doi.org/10.1016/j.ijinfomgt.2018.12.006>

GERBANG KOLEK: FASHIONING AN ICONIC UMK GATEWAY

Juliza Mohamad

Faculty of Architecture and Ekistics, Universiti Malaysia Kelantan, 16300 Bachok, Kelantan, Malaysia
juliza@umk.edu.my

Muhammad Rizal Khairuddin, Azli Abdullah, Nik Nurul Hana Hanafi, Sifi Aisyah Muhammad, Nor Hafizah Anuar, Najah Md Alwi, Yasmin Mohd Faudzi, Mhd Hafiz Karami Mhd Zain, Nuzul Haqimi Muhammad, Ismi Luqman Hamadi Ibrahim

Faculty of Architecture and Ekistics, Universiti Malaysia Kelantan, 16300 Bachok, Kelantan, Malaysia
rizal.k@umk.edu.my, hana.h@umk.edu.my, aisyah@umk.edu.my, norhafizah@umk.edu.my,
najah.ma@umk.edu.my, yasmin.mf@umk.edu.my, hafiz.k@umk.edu.my, nuzulhaqimi@umk.edu.my,
hamadi.i@umk.edu.my

Highlights: Gateways identify entrance points to the key destinations as well as its area which provide a unique sense of identity, transition, and anticipation. Gateways may have a variety of configurations and scales. From regional to community to the neighborhood scale, gateways can be created through a variety of styles, including architectural, monumental, or landscape. This study aims to propose an Iconic gateway for Universiti Malaysia Kelantan that represents the heritage element significantly of Kelantan cultural heritage. The architectural design concept which is developed and applied into the design inspired by 'Perahu Kolek'. The innovation of Gerbang Kolek has potential to be a landmark as well as an iconic monument in Bachok.

Key words: *heritage, GERBANG KOLEK, Perahu Kolek, iconic, gateway, landmark*

Introduction

The name of GERBANG KOLEK is inspired by a small wooden boat which is called Perahu Kolek. Perahu Kolek is a traditional fishing boat used on the eastern coast of peninsular Malaysia, including Kelantan. The perahu is also known as a boat. The Malay community used it during the Holocene period when the rise of the sea level altered the Malay world and became islands and a peninsula. The perahu became a necessity, not only as a navigational vessel but served as a shelter during the journey. Thus, this conceptual idea is translated into the gateway as the 'perahu' itself is oftentimes used as a navigator and bridge for communities to engage and interact. This project is a design proposal for UMK to improvise and create a more effective and culturally inspired design integration into the University's vicinity. It is situated at the back entrance of the current UMK Gateway, in which UMK is the main potential client for this project. The general outlook and appearance of the design are inspired heavily by the 'Perahu Kolek' as it is one of the preserved and conserved heritage and traditional elements of the state of Kelantan. The design approach for this concept is to generally create a landmark and iconic structure that could best represent the University and the state of Kelantan itself. It is a representation symbolically of the journey of a student as well as a navigating medium through which the community is bridged to the University.

Design Development

'Gerbang Kolek' proposal offers a huge anthropomorphic sculptural volume with its head sitting on the edge of the entrance plaza and its body set back by the side. The design transforms a high elongated shape, as the monument, into the curvature and slanting shape of the functional part. The 'perahu' translation creates ample space between the curved spaces, and this space shapes the axis of movement under a huge vault. Taking account of the vacant surroundings and lack of horizon of the site, this design projects a contrast and vertically expansive landmark that is very iconic in its surrounding context. The monumental gate looks simple from the front and complex when viewed from the side. It induces tension inside, which helps the entrance be more inviting than the typical gateway designs usually used in University entrances. It has a slight angle to the ground to frame the sky and to create a better viewing angle. Dynamism and the sense of movement in the element are related to the activities of the entrance gateway motion. The design strategy was based on the use of dynamic forms such as organic design elements and families of curved forms that resemble the structure of the 'perahu Kolek' and the student's journey that is hypothetically being represented by the journey embarked by the 'perahu' itself.

This project aims:

1. To bridge the local community with the University;
2. To provide a significant landmark and iconic structure within the vicinity of the University
3. To provide easier access for the locals to access the University
4. To provide better safety measures as the current gateway is usually not in use and lacks proper maintenance.

The idea was started by brainstorming the most suitable heritage element of Kelantan that can be developed as an iconic gateway. The ideation was then improvised using sketches and 3D modelling to grasp the virtual views of the specific location of the proposed UMK Gateway. Finally, the design was finalised and named Gerbang Kolek.



Figure 1: Perahu Kolek as the inspired Kelantan heritage element for the UMK Gateway

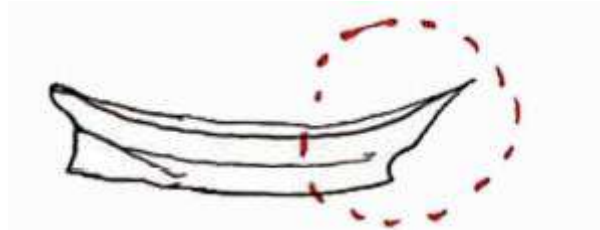

Figure 2: The selection of Perahu Kolek element for the Gerbang Kolek design development

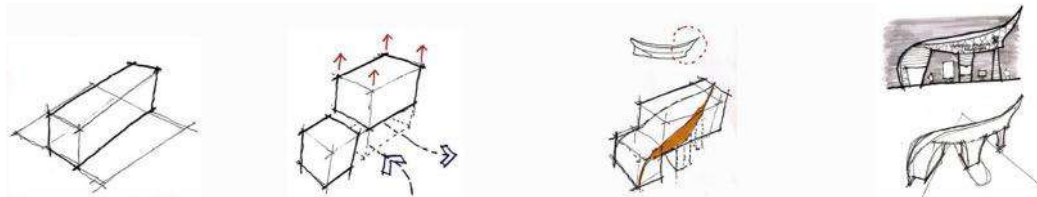

Figure 3: The design development for Gerbang Kolek

Background Of Innovation

This project was initiated to design an iconic gateway for UMK by enhancing the heritage characters to the design. The design incorporates the inspiration of Perahu Kolek with the integration of modern materials. Therefore, Gerbang Kolek became a significant monument that represents the local heritage adaptation of appreciation. The gateway focuses both on vehicular and pedestrian users. With the convenient pedestrian walkways, Gerbang Kolek also provides a conducive waiting area for visitors. The consideration of site opportunities and constraints contributes the various design solutions; for example, using shading devices to help the issue of excessive sunlight to reduce the high solar radiation intensity causing glare or overheating. At the same time, it serves as a comfortable refuge for the occupants near the gateway as a shelter and communal area for the students, staff and nearby community of the University.

Advantages Of Innovation

The idea of designing the UMK Gateway is based on several possibilities, such as the purpose of the selected entrance for this UMK Gateway usually used by the staff, students and visitors as the secondary access towards UMK. Therefore, it can be an iconic monument that represents UMK and the heritage of Kelantan as well. the design of Gerbang Kolek provides several advantages, namely:

1. Serves as a landmark for the local site context.
2. Serves as an iconic monument for UMK.
3. Represents the Kelantan heritage.
4. Represent a move in line with the future with its overall modern design overlook and material usage.
5. Provides a convenient pedestrian area.
6. Provides a shaded area from undesirable hot and rainy weather.
7. Provides a shaded area for vehicles, specifically motorcycles.
8. Provides a better security outlook around the site.

Commercial Values

Gerbang Kolek works as an iconic gateway for UMK and significantly become an example of local heritage adaptation of appreciation. Thus, this design can be commercialised as a UMK landmark that can promote and introduce UMK while also being used for UMK souvenirs and merchandise items. This design may be registered for Copyright or even as an Intellectual Property MyIPO.



Figure 4: Views from different angles of Gerbang Kolek



Figure 5 : Elevations of Gerbang Kolek

Acknowledgment

We are grateful for the excellent contributions from Mohd Khairuldin Mohd Rased, Lee Shin Yee, Nuraliya Shahira Kamil, and Muhammad Syafik Syazwan Mat Yaakub in completing the project.

References

<https://aasarchitecture.com/2018/08/a-monumental-entrance-gate-for-the-atomic-energy-organization-of-iran-by-habibeh-madjidi-badi.html/>

IE-SMART TRACKER 3.0 (INTELLIGENT EMPLOYABILITY SMART TRACKER 3.0)

Khairul Azhar Mat Daud

Faculty of Creative Technology and Heritage, Creative, Universiti Malaysia Kelantan, Malaysia
azhar.md@umk.edu.my

Balakrishnan Parasuraman¹, Ena Bhattacharyya²

¹Faculty of Entrepreneurship and Business, Universiti Malaysia Kelantan, Malaysia,

²Management Humanities Department, Universiti Teknologi PETRONAS, Malaysia
balakrishnan@umk.edu.my, ena_bhattacharyya@utp.edu.my

Highlights: Intelligent Employability Smart Tracker (ie SmarT Tracker) is a software that help graduate to find a job and employer to find the suitable employee. This software will identify graduate criteria on Work Readiness, Employability Skills, Functional work skills, social skills, Entrepreneurial skills, Communicative competence and Cognitive skills by making them to give rating on each criterion that they best of. Using this software, employer that want to find employee will also give rating on each criterion to show that what criteria that important to them. This software will automatically find the best graduate with criteria that suit with employer need.

Key words: employability, work readiness, software, job searching, social science, humanities

Introduction

The rising unemployment rate among graduates in Malaysia year after year can cripple the national economy (Norliana, Chang Peng Kee & Mat Pauzi, 2016). The problem of rising unemployment among graduates in Malaysia year after year has not only harmed graduates, families and educational institutions, but it can cripple the country's economy because this human capital cannot be highlighted successfully to develop the country. (Norliana, Chang Peng Kee & Mat Pauzi, 2016). According to (Holden, Jameson and Parsons, 2002), most employers are keen to find a graduate who is proactive and can use top -level skills including skills in analyzing, critiquing, synthesizing and communicating with various age groups. This idea of software came while in the process of research study under Matching Grant Universiti Malaysia Kelantan (UMK) and Universiti Teknologi PETRONAS (UTP) in explores on Stakeholder's perceptions of work readiness and employability skills among graduates from universities in Malaysia. The idea to innovate a specific application for university students to suit their expertise and skills was created. This aims to help them find work in this era of rising unemployment. This creation of UMK-UTP Innovation 2021 Intelligent Employability Smart Tracker (ieSmarT Tracker) software will expected to help graduate to find suitable job with their best criteria and employer to find employee with the best criteria that needed by them.

Content

This innovation of IE-Smart Tracker 3.0 and the name of the research grant that produces the stated innovation is the Matching Grant UNIVERSITI MALAYSIA KELANTAN (UMK)- UNIVERSITI TEKNOLOGI PETRONAS (UTP). This innovation is hoping to produce an integrated system to be an intermediate match of students' marketability skills with industry requirements that will coordinate student skills based on industry needs. This will show that this innovation is important to education because it can replace the physical job fair with an e-job fair and aiming to help the graduate find work in this era of rising unemployment.. If this software is a success, the usedness of this software will widespread and will benefit no only graduate and employer but also to the country.

Acknowledgement

We would like to thank Research Innovation and Management Centre (RMIC), Universiti Malaysia Kelantan and Research Management Centre, Universiti Teknologi PETRONAS for providing the Research Matching Grant UMK - UTP (Project Code: R/SGJP/A0100/00861A/2018/00572).

References

- Holden, R., Jameson, S. and Parsons, D.J. (2002). New graduate employment within SMEs: Still in the dark? (Journal of Small Business and Enterprise Development)
- Norliana, Chang Peng Kee & Mat Pauzi. (2016). Stops: Mengungkai Isu Kebolehpasaran Graduan Di Malaysia. (Jurnal Komunikasi: Malaysian Journal of Communication)

MODEL OF DEPRESSION, ANXIETY AND STRESS, EMOTIONAL INTELLIGENCE AND SATISFACTION OF WORK-LIFE BALANCE

Rogis Baker

Universiti Pertahanan Nasional Malaysia, Kuala Lumpur, Malaysia
rogis@upnm.edu.my

Hassan Al-Banna Mohamed, Nur Fatimah Husna Mohamad Puzi, Nur Surayya Mohd Saudi, Haliza Mohd Zahari

Universiti Pertahanan Nasional Malaysia, Kuala Lumpur, Malaysia
hasanalbanna@upnm.edu.my, husnapuzi@gmail.com, nursurayya@upnm.edu.my, haliza.mz@upnm.edu.my

Highlights: Model of Depression, Anxiety and Stress, Emotional Intelligence and Satisfaction of Work-Life Balance is a new framework built on the results of successful testing conducted on respondents of the study among 995 officers and personnel of the Malaysian Army (TDM). The construction of the new model structure framework by making DAS an independent variable is a new matter as das-related studies were not found in the study of organizational behaviour. While the results of the study showed that emotional intelligence plays a role as a moderator of the relationship between depression, anxiety, stress, and satisfaction of work -life balance.

Key words: *Emotional intelligence, depression, anxiety, stress, work-life balance*

Introduction

Model of Depression, Anxiety and Stress, Emotional Intelligence and Satisfaction of Work-Life Balance is a new framework built on the results of successful testing conducted on respondents of the study among 995 officers and personnel of the Malaysian Army (TDM). Emotional intelligence is a set of characteristics and abilities that encompass a wide range of human capacities and limits, commonly referred to as social and intra-singular abilities, that extend beyond the conventional fields of clear side interest, general information, and inventive or blessings abilities. Hence, it acted as a moderator on the relationship between depression, anxiety, and stress (DAS) with work and life balance satisfaction. The construction of the new model structure framework by making DAS an independent variable is a new matter as das-related studies were not found in the study of organizational behaviour. This is because most studies related to DAS are focused only on the medical field.

Content

Proposing a systematic model and framework for military organizational behavior which can be used by all organizations especially Malaysian Army when related to psychological self-control. Literature studies have also shown that no such model has been tested and applied in any field of research. This model has been registered copyright through the Intellectual Property Corporation of Malaysia (MyIPO) on 2 July 2021 (Application No: LY2021E02307). This model has also been proven through the tests that have been conducted in this study as discussed in the below figure 1 related Assessment of the Structure Model towards respondents in army officers and members throughout Malaysia. The tests showed emotional intelligence plays a role as a moderator to the relationship between depression ($t=2.621$, $p<0.01$), anxiety ($t=3.818$, $p<0.01$), stress ($t=2.088$, $p<0.01$) with satisfaction of work-life balance. While variables depression ($t=2524$, $p<0.01$), anxiety ($t=2,286$, $p<0.01$), stress ($t=2,620$, $p<0.01$) and emotional intelligence ($t=14,285$, $p<0.01$) have a direct positive significant relationship with work-life balance satisfaction.

Practically, this study has provided an opportunity for organizations to identify and practice the balance of daily working lives and engage in a positive group that is good at achieving high levels of emotional intelligence and lack of depression, anxiety, and stress issues. In the other hand, this study can be used as a guideline to improve work and life balance especially in career as a military in Malaysia. Depression, anxiety, and stress are independent variables and work-life balance is dependent variable. Emotional intelligence is moderator variable. This model is newly built, and no such model has been studied in previous studies. This is because the variables of depression, anxiety, and stress (DAS) are constructs that are often used in medical field. Although these variables are often used in medical fields, but the construction of models combined with variables related to social sciences has not been done. Literature reviews also showed that no such model has yet been tested and applied in any research field. The management of the Malaysian army can use the findings of this study as a guide to design activities that can improve psychological self-control among military personnel.

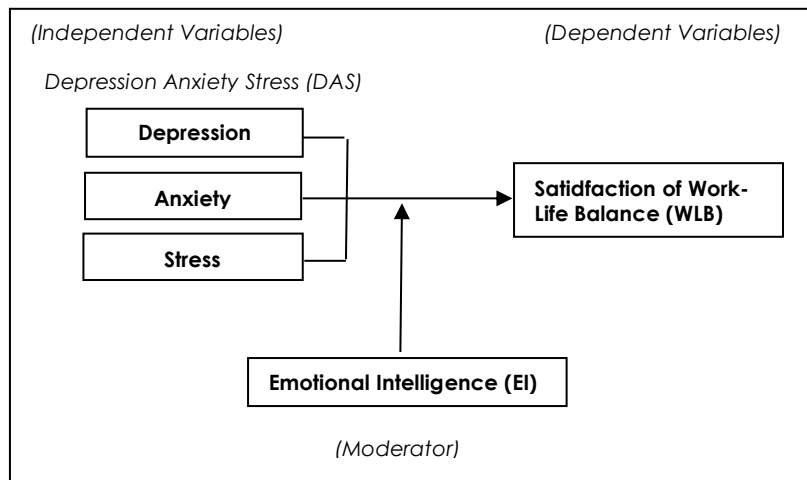

Figure 1: Model of Depression, Anxiety and Stress, Emotional Intelligence and Satisfaction of Work-Life Balance

Acknowledgement

This research was supported by Ministry of Education (MOE) through Fundamental Research Grant Scheme (FRGS/1/2020/SS0/UPNM/02/5)

References

- Adkins, C. L., & Premeaux, S. F. (2019). A cybernetic model of work-life balance through time. *Human Resource Management Review*, 29(4), 1-13 100680. <https://doi.org/10.1016/j.hrmr.2019.01.001>
- Adwas, A. A., Jbireal, J. M., & Azab, A. E. (2019). Anxiety: Insights into signs, symptoms, etiology, pathophysiology, and treatment. *East African Scholars Journal of Medical Sciences*, 2(10), 580-591.
- Baker, R. (2010). Hubungan antara kecerdasan emosi dan komitmen pekerja: Kajian di kalangan pegawai polis. Master dissertation, Universiti Malaysia Sarawak.
- Baker, R., Jaaffar, A. H., Sallehuddin, H., Hassan, M. A., & Mohamed, R. (2019). The relationship between emotional intelligence and affective commitment: An examination of police officers. *International Journal of Recent Technology and Engineering*, 8 (2S9), 658-665.
- Bar-On. (2000). Emotional and social intelligence: Insights from the Emotional Quotient Inventory. In R. Bar-On, & I. D. A. Parker (Eds.), *The handbook of emotional intelligence: Theory, development, assessment, and application at home, school, and in the work place*, 363-388.
- Henseler, J., Ringle, C.M., & Sinkovics, R.R. (2009). The use of partial least squares path modeling in international marketing. In Sinkovics, R. R. & Ghauri, P. N. (eds.), *Advances in International Marketing* (pp. 277-320), Bingley:Emerald.
- Johari, M. D. (2013). Morel dan pengaruhnya terhadap motivasi dan komitmen di kalangan anggota Tentera Darat Malaysia. Doctoral dissertation, Universiti Tun Hussein Onn Malaysia.
- Mayer, J. D., Caruso, D., & Salovey, P. (2000). Emotional intelligence meets traditional standards for an intelligence. *Intelligence*, 27(4), 267-298. doi:10.1016/s0160-2896(99)00016-1
- Salovey, P., & Mayer, J. D. (1990). Emotional intelligence. *Imagination, Cognition and Personality*, 9(3), 185-211. doi:10.2190/dugg-p24e-52wk-6cdg
- Sprung, J. M., & Rogers, A. (2019). Work-Life balance as a predictor of college student anxiety and depression. *Journal of American College Health*, 1-8. <https://doi.org/10.1080/07448481.2019.1706540>
- Subbalakshmi, B. H. (2019). an empirical study on employees' work-life balance through emotional intelligence in I.T. sector in Hyderabad City. *International Journal of Indian Economic Light*, 7 (19-29).
- Swathi, R., & Mohapatra, D. (2015). Work-life balance: Evolution and models-a study in the Indian context. *International Journal of Science and Research*, 6 (5), 1910-1914.
- Vasumathi, A., Sagaya, M. T., & Poranki, K. R. (2019). The impact of emotional intelligence on work life balance among the faculty
- Wong, C. S., & Law, K. S. (2002). The effects of leader and follower emotional intelligence on performance and attitude: An exploratory study. *The Leadership Quarterly*, 13(3), 243- 274.
- Wolor, C. W., Solikhah, S., Fidhyallah, N. F., & Lestari, D. P. (2020). Effectiveness of e-training, e-leadership, and work life balance on employee performance during COVID-19. *The Journal of Asian Finance, Economics and Business*, 7(10), 443-450..

NEW INTEGRATION MODEL OF HUMAN DIMENSIONS WITH MILITARY MINDS AND PATRIOTISM AMONG MALAYSIAN ARMED FORCES

Jessica Ong Hai Liaw

National Defense University of Malaysia, Kuala Lumpur, Malaysia
jessica@upnm.edu.my

Nora Ibrahim

National Defense University of Malaysia, Kuala Lumpur, Malaysia
nora_am91@yahoo.com

Highlights: Presently, integrating human dimensions with military minds and patriotism among Malaysian Armed Forces (MAF) officers are important to sustain in the era of societal impact during 4.0 Industry Revolution (IR). MAF are divided into the Malaysian Army, Royal Malaysian Navy (RMN) and Royal Malaysian Air Force (RMAF). MAF acknowledge their human capital as the main dimension in their role and task to protect the sovereign of the Malaysia. Therefore, this study will be conducted to determine the mediating role of human dimension (talent) with the relationship between military mind (heroism, clear behaviour, military decency, responsibility for equipment, military skills, motivation) and patriotism.

Key words: *heroism, clear behavior, military decency, responsibility for equipment, military skills, motivation and patriotism.*

Introduction

The MAF will continue to serve the government of the day and always stay loyal to the King and nation. All information is now easily available. Therefore, MAF personnel need to be matured and should not be easily influenced by information that comes from unauthenticated sources. We should take precedence, especially in the use of technology and handling it wisely. According to Zulkifli Zainal Abidin (2014), the human dimension encompasses the moral, physical, and cognitive components of soldier, leader, and organizational development and performance essential to raise, prepare, and employ the Army in full spectrum operations. Army concepts acknowledge the soldier as the centrepiece of the Army, but none, individually or collectively, adequately addresses the human dimension of future operations (Franco et al, 2018). The soldier performance attribute groupings in the moral, cognitive, and physical domains provide a platform for the intangible factor needed in the human interface in man machine method. Today the across the world everyone is facing several challenging, dangerous, and potentially inescapable geo-strategic trends (Tillberg, 2020). These trends include social and cultural factors; the dynamics of geopolitics and governance; the globalization of economics and resources; the revolution in science, technology, and engineering; and, global climate change. The machine is just a tool for the soldier in battlefield and the tactics is the method but overall the soldier is the platform using all his training in cognitive reasoning in making significant decisions in the battlefield whereby the machine a method is just the psycho motor aspect in assisting him meet his goals. At such what would the emphasis be for the future COE in relation to the human dimensions of soldiers especially the Y generation soldiers? How will Armed Forces deal with such changing environment and technological advancements to ensure the human dimension in soldiers continue to uphold the warrior spirit? Maybe the future training and education for individual and collective training for soldiers need to be relook and seek new avenues in terms of the push and pull factor for soldiers? The solution probably will be derived from how best we recruit, train, and retain our forces including the package of training methods of which soldiers can operate across the spectrum and range of military operations in the future operational requirement.

Objective of the Research

- (1) To examine the key dimensions of military minds as a determining factor of human dimensions and patriotism.
- (2) To test the extend of mediating effects of human dimensions with military minds and patriotism.
- (3) To propose a new model of human dimensions, military minds and patriotism.

Content

Product Description

Proposing a systematic model and framework assessment for integrating human dimensions with military minds and patriotism among Malaysian Armed Forces which can be used by all security forces in Malaysia especially when working together in combined and joint operations both local and international duties. The study will contribute, to be the best practice for developing training method for future military officers, to develop a new integration model of human dimension with military mind, patriotism in conjunction of National Defense White Paper and to apply this integration model at schools and academic institutions to enhance patriotism among leaders of Malaysia.

Commercialization & Intellectual Property

To prove the significance of perceived value in the integration model of human dimensions with military minds and patriotism in conjunction of National Defence White Paper. To determine the applicability of human dimensions, military minds and patriotism and theories in the studied organizations towards 4.0 IR Society Foresight.

Significance and relevant for security forces in Malaysia namely Malaysian Army, Royal Malaysian Air Force, Royal Malaysian Navy, Royal Malaysian Police, Malaysian, Maritime Enforcement Agency and other relevant security forces

Specific or Potential Applications Potential Applications:

- (1) to be the best practice for developing training method for future military officers.
- (2) to develop a new integration model of human dimension with military minds and patriotism.
- (3) to apply this integration model at schools and academic institutions to enhance patriotism among future leaders of Malaysia.

Impact on Society, Economy and Nation

The study will contribute:

- (1) to be the best practice for developing training method for future military officers towards societal impact 4.0 (IR).
- (2) to develop a new integration model of human dimension with military minds and patriotism for MAF.
- (3) to apply new integration model at schools and academic institutions to enhance patriotism among future leaders of Malaysia.

Acknowledgement

This research was supported by the Ministry of Education (MOE) through Fundamental Research Grant Scheme (FRGS/1/2019/SS03/UPNM/02/1). We also want to thank to the Government of Malaysia which provides MyBrain15 program for sponsoring this work under the self-fund research grant and L00022 from Ministry of Science, Technology, and Innovation (MOSTI).

References

- Ahmad Rusdi A. (2002). *Permasalahan Pelaksanaan Unsur Patriotisme Dalam Mata pelajaran Kajian Tempatan: Punca Daripada Guru Sendiri*. Alor Setar: Institut Pengurusan Darul aman.
- Allison, S. T., Goethals, G. R., Kramer, R. (Eds.). (2017). *The handbook of heroism and heroic leadership*. New York, NY: Routledge.
- Burhanuddin, J. (2016). Hubungan Tentara dan Masyarakat: Pandangan Rakyat Terhadap Peranan Angkatan Tentera Malaysia (Military and Community Relations: Peoples view on the role of the Armed Forces). *Journal of Advanced Research in Social and Behavioural Sciences*, Vol. 4, No. 1. Pp 19 – 30.
- Efthimiou, O. (2015). The search for a hero gene: Fact or fiction? *Heroism Science*, Vol 1 (1), pp-6.
- Feigin, S., Owens, G., Goodyear-Smith, F. (2014). Theories of human altruism: a systematic review. *Annals of Neuroscience and Psychology*, 1(1).
- Franco ZE, Allison ST, Kinsella EL, Kohen A, Langdon M, Zimbardo PG (2018). Heroism Research: A Review of Theories, Methods, Challenges, and Trends. *Journal of Humanistic Psychology*. 2018;58(4):382-396.
- Franco, Zeno, Blau, & Zimbardo. (2011). Heroism: A Conceptual Analysis and Differentiation Between Heroic Action and Altruism. *Review of General Psychology*, 15, 99-113. 10.1037/a0022672.
- Johansen, R. B., Martinussen, M., & Kvilvang, N. (2015). The Influence of Military Identity on Work Engagement and Burnout in the Norwegian Army Rapid Reaction Force. *Journal of Military Studies*, 6(1), 38-48.
- Keczer Z, File B, Orosz G, Zimbardo PG (2016) Social Representations of Hero and Everyday Hero: A Network Study from Representative Samples. *PLoS ONE*, Vol 11(8)
- Kinsella, E. L., Ritchie, T. D., Igou, E. R. (2015a). Zeroing in on heroes: A prototype analysis of hero features. *Journal of personality and social psychology*, 108(1), 114-127.
- Klisanin, Dana (2016) "Collaborative Heroism: An Empirical Investigation," *Heroism Science*: Vol. 1: Iss. 1, pp 1-14
- Ku Hasnita Ku Samsu, & Mohd Haizam Mohd Nor, (2009). Semangat patriotisme dalam kalangan mahasiswa bukan Melayu di Institut Pengajian Tinggi, sekitar Lembah Kelang. *AKADEMIKA*. Vol 75. pp. 85-100.
- Muhamad Ali Embi. (2009). *Patriotisme dan Kalangan Rakyat di Malaysia*. Utusan Publications & Distributions Sdn Bhd, Kuala Lumpur.
- Ruhaiza, R. (2015). *Patriotisme sebagai senjata mental*. My Metro (online). Malaysia. Assessed on 1 November 2020.
- Saifuddin Abdullah. (2002). *Patriotisme Alaf Baru*. Kertas Kerja dibentangkan di Kongres Patriotisme Negara, di Institut Latihan Keselamatan Sosial KWSP, anjuran Biro Tatanegara dan Universiti Utara Malaysia, Bangi pada 22 - 28 Oktober 2002
- Siti Naquiah Abdillah (2015). *Semarakkan Semangat Patriotisme Secara Berterusan*. Berita Mutakhir. Laman Web Rasmi Universiti Sains Malaysia. <https://news.usm.my/>
- Smith, S. F., Lilienfeld, S. O., Coffey, K., Dabbs, J. M. (2013). Are psychopaths and heroes twig off the same branch? Evidence from college, community, and presidential samples. *Journal of Research in Personality*, 47, 634-646.
- Stenstrom, D., & Curtis, M. (2012). Heroism and risk of harm. *Psychology, Scientific Research*, 3(12A), 1085-1090.
- Victor Tillberg, L. (2020). The Dynamics of Military Skills: The Role of Experience-Based Knowledge in Challenging Situations. *Scandinavian Journal of Military Studies*, 3(1), 55-67. DOI: <http://doi.org/10.31374/sjms.40>
- Wansong, H (2018). Analysis on the Necessity of Military Training in the Cultivation of Patriotism of College Students. *Advances in Computer Science Research*. Vol 83, pp 826-828.
- Zook C., L. (2016). *Military Experience and The Shaping of Nationalism in The U.S. Armed Forces*. Doctor of Philosophy Thesis. University of Pittsburgh. Pennsylvania, United States
- Zulkifli Zainal Abidin (2014). The Human Dimensions Of Soldering:A Perspective on Future Requirements in the Complex Operational Environment. *Journal European Scientific Journal August 2014 /SPECIAL/ edition ISSN: 1857 – 7881 (Print) e - ISSN 1857- 7431*

APPENDIXES

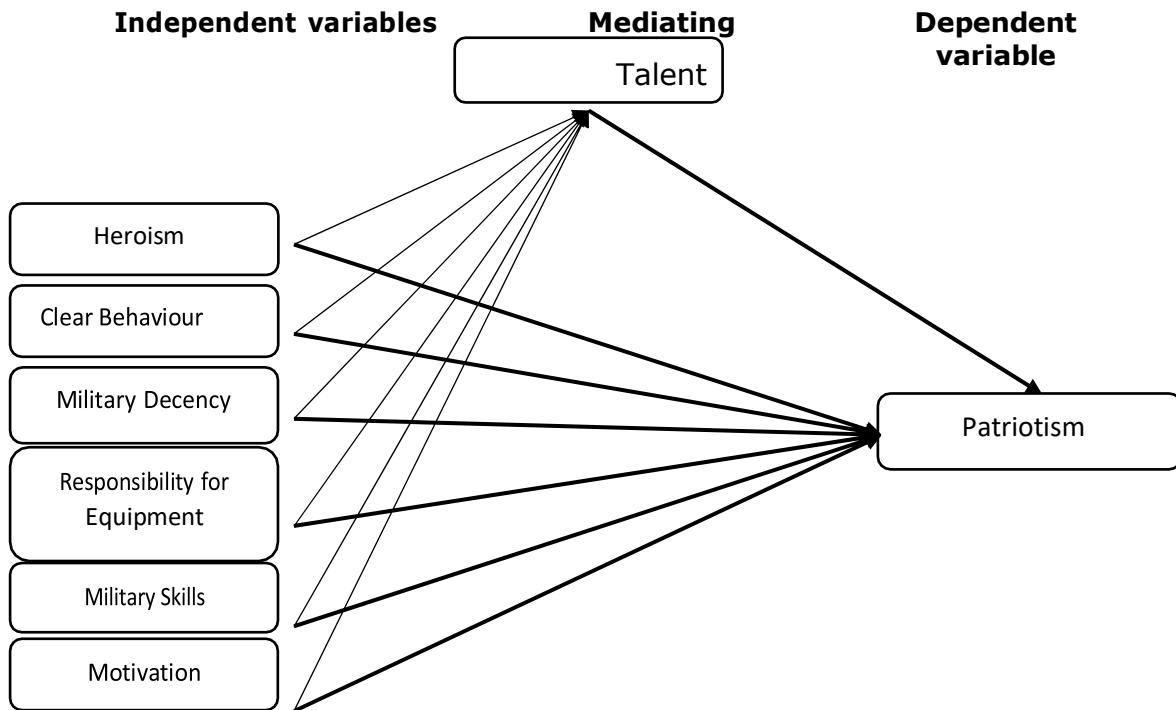

Figure 1: Framework of the study

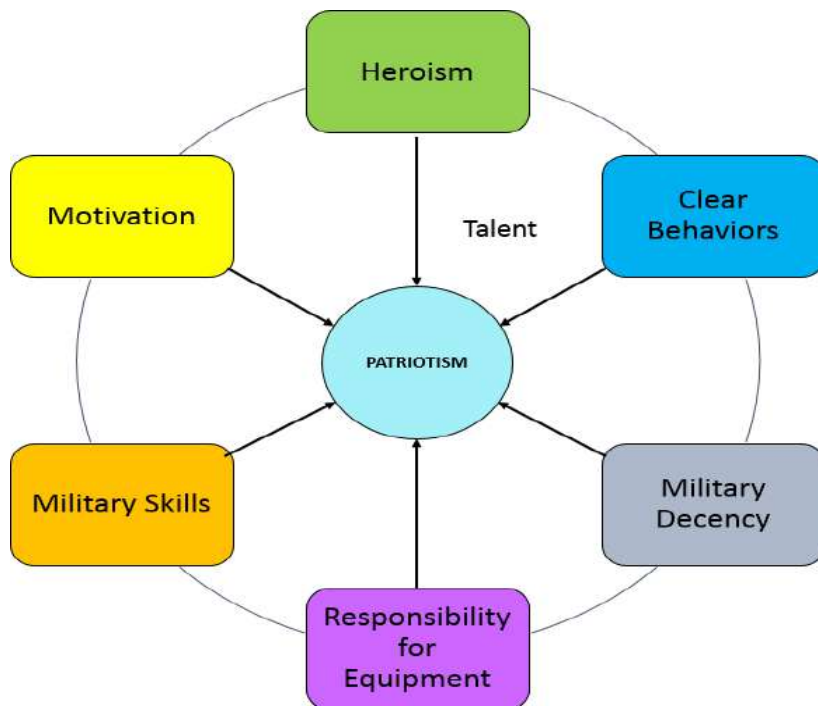

Figure 2: The Proposed of New Integration Model of Human Dimensions with Military Minds and Patriotism



KDSI, LUMUT PERAK



KTD, PORT DICKSON



KTU, ALOR SETAR



MPAT, PUSPAHANAS



NDUM. SG BESI

INTERPRETATION OF NATURE IN LITERATURE THROUGH FILM ADAPTATION

Sudirman Kiffli

Fakulti Teknologi Kreatif dan Warisan, Universiti Malaysia Kelantan, Bachok, Kelantan, Malaysia
Sudirman.k@umk.edu.my

Nordiana Ab Jabar, Suraya Sukri, Ainul Wahida Radzuan, Farrah Atikah Saari, Siti Nur Anis Muhammad Apandi

Fakulti Teknologi Kreatif dan Warisan, Universiti Malaysia Kelantan, Bachok, Kelantan, Malaysia
Nordiana.aj@umk.edu.my, suraya@umk.edu.my, ainul@umk.edu.my,
atikah.s@umk.edu.my, nuranis.m@umk.edu.my

Highlights: Interpretation of Nature in Literature through Film Adaptation is a method to analyse the elements of nature embedded in selected film adaption in Malaysia. This method of interpretation helps in giving student an understanding of the elements of nature in film adaptation which is indirectly a reflection of their understanding on the literary works. Through this study, student will be exposed to the selected film adaptation and they are required to define nature element in the film and express their interpretation on that particular nature elements.

Key words: *interpretation, film adaptation, nature, ecology*

Introduction

Research on a literary work in the context of society is now greatly assisted by the existence of film adaptation. Film adaptation refers to the film produced by adopting the literary work and transform them into film form. Film adaptation also a work that is produced by sourcing a particular literary work regardless of the traditional or modern literature. Through the method of interpretation in film adaptation, young generation will be easier to be reach because it fits the context of their wishes that are close to the new media technology.

Through watching film that adapted from literary works, they can give their interpretation based on their observation through the visual shows from the film and they also can use hearing ability from the audio effect of the film itself that evoke more of their senses of sight, hearing and taste. Therefore, the research in this study focuses on analysing the ability of film adaptation in impacting young generation (focuses on student). This study also giving an exposure to the young generation in understanding literature especially on the elements of nature instilled in the film.

Content

Student's (young generation's) understanding especially on the elements of nature instilled in a literary work is at a very difficult level. This is because those elements which displayed in the written work required a very deep understanding and interpretation by reading and understanding each word and sentences. Therefore, through film adaptation, the elements of nature show more easily and directly because of the character of the film itself which exists in the visual and audio form. Based on that, film adaptation considered as one of the methods in understanding literary works that does not rely entirely on written or printed works. However, the new medium which is film adaptation will be implemented to understand the elements of nature found in the film that are sourced from literary work.

To mention, the elements of nature can be captured in film adaptation include the natural element and human made element. Natural element of nature categorised into several aspects which is physical nature and non-physical element. Physical element include any physical element that exist naturally include the sun, moon, mountain, hill, river and the sea. Meanwhile, non-physical element such as flora, fauna, biotic, abiotic and microorganism. Other that, human made element also can be found in film adaptation such as the building, road, etc. All those natural and human made element are considered as nature that implemented in the film adaptation which is adapted from literary work.

From elements mentioned, this study aims to grab student's attention and expose them to the context of understanding literary work from film adaptation. It is also considered as new method which drives into an inventive learning in literature itself which involved:

- 1) Easier method to understand film adaptation especially for the young generation.
- 2) The existence of film adaptation which in-line with the development of Industrial Revolution 4.0 (IR4.0) Development.
- 3) Understanding of the nature elements in film adaptation implemented among the young generation (students).

Through the inventive mentioned, this study also encourage the young generation to get close to literary works that are previously considered as outdated and irrelevant in their perspective. Otherwise, this study which related with film adaptation is more accessible with the existence of various online streaming platform such as Netflix, Ifix, Disney Online etc. The existence of those streaming platform gave more spaces and advantages for the literary work to be adapted into film. There are several examples of film produced which adapted from literary work globally include film Harry Potter which adapted from novel Harry Potter written by J.K Rowling, film The Help adapted from novel The Help written by Kathryn Stockett, film Tenggelamnya Kapal Van Der Wijck adapted from novel Tenggelamnya Kapal Van Der Wijk written by Hamka, film Ombak Rindu adapted from novel Ombak Rindu written by Fauziah Ashari and many more. The numbers of film adapted from literary work which become bigger is a good sign for the field of literature itself and all of those film surely include the nature element which give more spaces for the viewer or the student to understand the context and meaning of those elements.

Main theoretical framework which can be implemented in this study in Film Adaptation suggest by many scholars such as Linda Hutcheon, Brian McFarlane and several others. The potential of this study opened a wider chances for the field of literature itself and indirectly it can help for the learning process. Students at any level include school level and higher level indirectly dismisses the view that literature as a boring and outdated.

To conclude, this study hopes that the implementation of film adaptation in understanding literature will be more accepted by the young generation and give them more spaces to express their understanding on the literary work.

Acknowledgement

We are grateful for the chances given to join CRI 2021 and express our ideas and present our research. Special thanks to Fakultas Teknologi Kreatif dan Warisan for continuous support on our effort.

References

- Andy Fenton & Matthew Spencer (2010). *Ecosystem Ecology: A New Synthesis* (ed. David G. Raffaelli, Cristopher L. J. Frid). Cambridge University Press.
- Halimah Mohamed Ali & Mohamad Luthfi Abdul Rahman (2014). *Sastera Dalam Budaya dan Media*. Penerbit Universiti Sains Malaysia.
- Hutcheon, L & O'Flynn, S. (2013). *A Theory of Film Adaptation* (2nd Edition). Routledge Taylor Francis Group.
- Sony Sukmawan (2016). *Ekokritik Sastra: Menganggap Sasmita Arcadia*. UB Press.

RELIGION AS PEACEBUILDING: A CASE OF SABAH SOCIAL ENVIRONMENT

Suraya Sintang

Pusat Penataran Ilmu dan Bahasa, Universiti Malaysia Sabah, Kota Kinabalu
suraya@ums.edu.my

**Romzi Ationg¹, Mohd Nazmi Mohd Khalli¹, Khadijah Mohd Khambali @ Hambali²,
Syamsul Azizul Marinsah¹**

¹Pusat Penataran Ilmu dan Bahasa, Universiti Malaysia Sabah, Kota Kinabalu

²Akademi Pengajian Islam, Universiti Malaya, Kuala Lumpur

mratio@ums.edu.my, nazmikhalli.nk@gmail.com, syamsulazizul@ums.edu.my, ijamh@um.edu.my

Highlights: This paper presents a discussion on social innovation in designing the role of religion as a key for peacebuilding, in which it ultimately aims at improving social wellbeing within Malaysian plural society. Through series of fieldworks in the interiors, this study examines the social values of peoples in Sabah by emphasising the unity in religious diversity. The study shows that religion has not divide, rather encourage them to respect and tolerant with each other. Specifically, the narrative on unity in religious diversity there described by three social environments: one family-many religions; sharing graveyard; and building religious places in proximity.

Keywords: *social innovation, religious diversity, peacebuilding, Sabah, social environment, religious places*

Introduction

Sabah's religious diversity, as well as its distinct social environment, has been instrumental in fostering intercommunal tolerance and peaceful coexistence among the citizen there. In explaining such an idea, Pugh-Kitingan (2015) opined that there are numbers of factors associated with this phenomenon positively. She further suggests that those factors or the variables mainly due to the absence of dominant ethnic group, that families frequently comprise of members from different religious affiliations and the historical legacy of blood brothers' relationship between the Iranun-Muslim and the non-Muslim Dusunic communities (Lotud, Rungus and Kadazan). Though the phenomenon of peaceful coexistence remain significance in Sabah, it is important to note that social phenomenon is changing all the time. Therefore, the question, by now is, whether the peaceful coexistence or in other word, the social harmony, among the citizens in this land will be prolonged.

While acknowledging the importance of nourishing social harmony, this paper argues that sustaining harmony in religious diversity is not something that can easily be realised because religion is always prone to divide people into distinct social groups—However, the religious message in particular the Abrahamic heritage of Islam and Christianity encourage unity by emphasising ethical values of love for humankind. Bartoli (2004) points out the Christian message on peace by underlying the positive values of forgiveness, reconciliation, and the Jesus teaching on "brother from brother". Similarly, in Islam, the social philosophy of *muhabbah* (mutual love) (Haslina et al. 2016) and *rahmatan lil-alamin* (mercy to all) (Mohd. Nazmi et al., 2020) fostering unity in diversity. The social functions of religion promotes social cohesion (Shamsul Amri, 2011; Suraya et al., 2019), and social solidarity (Redekop, 1967; Cladis, 2017).

Despite that, however, it is important to note that not many, if not all, really comprehends the relationship between these variables. For this reason, this paper seeks to analyse the potential role of religion as a unifying factor through the application of a theoretical framework for peacebuilding. The analysis and discussion are thus based on information gathered through a series of fieldworks in the interiors of Sabah between September 2020 and April 2021. During the fieldworks, participant observations and interviews with local communities in the interior areas of Sabah, comprises of two districts namely Keningau and Kota Marudu were conducted. Such methodological approach led to the collection of empirical data needed for this study. The following section presents the findings and discussion of the study.

Findings and Discussion

As portrayed, the role of religion as what Nicosia (2016) described as the 'faith-based peacebuilders', has been the focal point of this study. Given the importance of religion in social life (peace), the positive atmosphere of Sabah's social environment and the social values of its people have been systematically considered for the construction of the model of unity in diversity. It is argued that the unity in religious diversity in this land (Sabah) is not a seasonal activity when the people of different religious background come together to celebrate festivities or interact with each other daily. Rather, the social environments that they are living in together encourages them, regardless of religious background, to getting socially closer due to the presence of family members of their own who practices different religions. This statement is confirmed by the empirical evidence gathered through participatory observation and interview with a total of 65 families or households located in the district of Keningau and Kota Marudu, the interior areas of Sabah in Malaysia (see Table 1 and Bar Chart 1).

Table 1: Distribution of Religions in Each Family (Mixed-Faith Family)

District	Ethnic group	Family	Number of religions in family	Type of religion					
Keningau	Dusun	1	3	Muslim	Christian	Indigenous religion			
	Dusun	2	3	Muslim	Christian	Indigenous religion			
	Murut	3	3	Muslim	Christian	Indigenous religion			
	Dusun	4	2	Muslim	Christian			Sikhism	
	Dusun	5	2	Muslim	Christian				
	Lobau	6	2	Muslim	Christian				
	Dusun	7	2	Muslim	Christian				
	Murut	8	3	Muslim	Christian	Indigenous religion			
	Kadazan	9	2	Muslim	Christian				
	Murut	10	3	Muslim	Christian	Indigenous religion			
	Visaya	11	2	Muslim	Christian				
	Visaya	12	2	Muslim	Christian				
	Dusun	13	3	Muslim	Christian	Indigenous religion			
	Dusun	14	2	Muslim	Christian				
	Iban-Murut	15	3	Muslim	Christian	Indigenous religion			
	Murut	16	2	Muslim	Christian				
	Murut	17	2	Muslim	Christian				
	Visaya	18	2	Muslim	Christian				
	Murut	19	3	Muslim	Christian				
	Murut	20	2	Muslim	Christian				
	Murut	21	2	Muslim	Christian				
	Murut	22	2	Muslim	Christian				
	Murut	23	2	Muslim	Christian				
	Kadazan	24	2	Muslim	Christian				
	Visaya	25	2	Muslim	Christian	Indigenous religion			
	Dusun	26	3	Muslim	Christian	Indigenous religion			Buddhism
	Kadazan	27	4	Muslim	Christian	Indigenous religion			Buddhism
	Dusun	28	3	Muslim	Christian	Indigenous religion			Buddhism
	Dusun	29	3	Muslim	Christian	Indigenous religion			Buddhism
	Kadazan	30	3	Muslim	Christian	Indigenous religion			Buddhism
	Kadazan	31	3	Muslim	Christian	Indigenous religion			Buddhism
	Dusun	32	3	Muslim	Christian				Buddhism
	Kadazan	33	3	Muslim	Christian				Buddhism
	Sino	34	3	Muslim	Christian				Buddhism
	Kadazan	35	4	Muslim	Christian	Indigenous religion			Buddhism
	Rungus	36	2	Muslim	Christian				
	Kadazan	37	3	Muslim	Christian	Indigenous religion			Buddhism
	Kadazan	38	4	Muslim	Christian	Indigenous religion			Buddhism
	Dusun	39	3	Muslim	Christian	Indigenous religion			Buddhism
	Kadazan	40	3	Muslim	Christian	Indigenous religion			Buddhism
	Murut	41	3	Muslim	Christian	Indigenous religion			Buddhism
	Rungus	42	2	Muslim	Christian				
	Murut	43	3	Muslim	Christian	Indigenous religion			
	Murut	44	2	Muslim	Christian				
	Kadazan	45	2	Muslim	Christian	Indigenous religion			
	Rungus	46	2	Muslim	Christian				
	Dusun	47	3	Muslim	Christian	Indigenous religion			
	Kadazan	48	2	Muslim	Christian				
	Kadazan	49	2	Muslim	Christian				
	Dusun	50	2	Muslim	Christian				
Kota Marudu	Kadazan	51	3	Muslim	Christian	Indigenous religion			
	Rungus	52	3	Muslim	Christian	Indigenous religion			
	Rungus	53	3	Muslim	Christian	Indigenous religion			
	Rungus	54	3	Muslim	Christian	Indigenous religion			
	Rungus	55	3	Muslim	Christian	Indigenous religion			
	Rungus	56	2	Muslim	Christian				
	Rungus	57	3	Muslim	Christian	Indigenous religion			
	Rungus	58	3	Muslim	Christian	Indigenous religion			
	Rungus	59	3	Muslim	Christian	Indigenous religion			
	Dusun	60	3	Muslim	Christian	Indigenous religion			
Dusun	61	3	Muslim	Christian	Indigenous religion				
Dusun	62	3	Muslim	Christian	Indigenous religion				
Dusun	63	3	Muslim	Christian	Indigenous religion				
Dusun	64	3	Muslim	Christian	Indigenous religion				
Dusun	65	3	Muslim	Christian	Indigenous religion				
Overall total number of religions				65	65	13	7	1	

Source: Fieldwork at Keningau and Kota Marudu conducted between September 2020 to April 2021

Bar Chart 1: Total number of religions in mixed-faith family

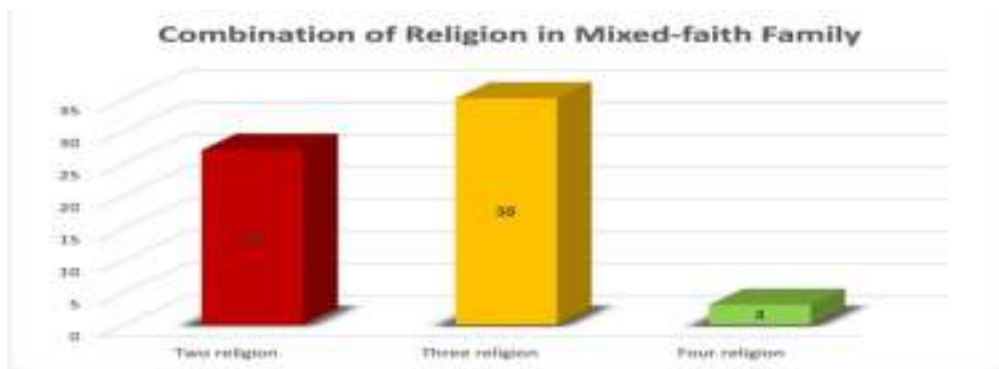

As clearly indicated in both Table 1 and Bar Chart 1, it appears that a combination of religion in mixed faith families has been a common social life in Sabah, particularly in Keningau and Kota Marudu. Specifically, the total of 65 households or families in both districts are characterised by the presence of family members who practices multi-religions. Some households even have two or three or four different religious practices by their own family members accordingly. The most common combination of religions within the family or household is Muslim and Christian, the dominant religions in Sabah. These two dominant religions often add to the traditional belief and religion, namely the ancestral indigenous religion/belief. In many cases, this also led to the addition of other non Abrahamic religions in the family (Buddhism or Sikhism).

Despite the presence of multi-religions in a family, they continue to function as one harmonious family. What this now hinted is that this type of family could generally be seen in Sabah, Malaysia. That is, with this in play, the relationship between the family members is always encouraging, harmonious, highly practiced in most families throughout Sabah and is highly accepted as a social norm of unity in religious diversity. The encouraging social phenomenon largely contributed by understanding that religion stresses the importance of peaceful coexistence and urged the people to respect and love one another. Therefore, it is not a surprise that religious diversity has not only been expressed within the context of family, but it has also been manifested in the society at large in Sabah. This is generally demonstrated when they feel awkward in sharing a cemetery or graveyard, build houses of worship close to each other, and attend different religious festivities together (Suraya, 2014; Aliran Admin, 27 Mar 2021).

Conclusion

Overall, the study portrays that religion can play a significant role in the formation as well as maintenance of harmony in a society. Therefore, the finding of this study must be regarded as a systematic call for making religion a key element of social harmony. Having said that, however, it is important to stress here that this study does not necessarily explain how religion is supposed to play such a role. Rather, it is highly relevant to the area of education and tourism sectors. In education, the way of life of the people in Sabah and the positive values of tolerant can be a lesson or role model to educate the community at the grassroots level for accommodating and accepting others as they are. Moreover, in the tourism sector, the findings portray the presence of potential of religious-based product commercialization in Sabah. Thus, the conceptual framework on religion as peacebuilding that based on a model of unity in religious diversity in Sabah's social environment must be taken into consideration to the drafting of the National Harmony Charter in line with the *rahmatan lil alamin* policy.

Acknowledgement

The researcher(s) of this study would like to express gratefulness for the research funds awarded by the Ministry of Education Malaysia through the Fundamental Research Grant Scheme (Project Code: FRG0527-1/2019).

References

- Aliran Admin. (27 Mar 2021). Sabah and Sarawak were promised religious freedom. *ALIRAN*. Retrieved from: <https://aliran.com/thinking-allowed-online/sabah-and-sarawak-were-promised-religious-freedom/> Bartoli, A. (2004). Christianity and Peacebuilding. In Harold C. & Gordon S. *Religion and Peacebuilding*. Albany: State University of New York.
- Cladis, M. (2017). Solidarity, religion and the environment: Challenges and promises in the 21st century. *Changing Societies & Personalities*, 1(4), 353-372.
- Haslina Ibrahim, Rohaiza Abd. Rokis and Wan Nurhanisah Wan Husin. (2016). Muhibah is not religious pluralism: The Understanding of Religious Coexistence among Religious Leaders in Malaysia. *Tafhim*, 9, 67-85. Mohd. Nazmi Mohd Khalli, Suraya Sintang, Syamsul Azizul Marinsah. (2020). Rahmatan Lil 'Alamin: Kerangka konsep keharmonian di Malaysia. *Sains Insani*, 5(2), 32-42.
- Nicosia, P. (2016). Faith-based peacebuilding: Insights from the three main monotheism. *Athens Journal of Social Sciences*, 4(1), 7-24.
- Redekop, C. (1967). Toward an understanding of religion and social solidarity. *Sociology of Religion: A Quarterly Review*, 28(3), 149-161.
- Pugh-Kitingan, J. (2015). Cultural and religious diversity in Sabah and relationships with surrounding areas (PP. 269- 294). In Ikuya Tokoro, Hisao Tomizawa, TokyoGaikokugo Daigaku & Ajia Afurika Gengo Bunka Kenkyujo (eds.). *Islam and Cultural Diversity in Southeast Asia*. ILCAA: Tokyo University of Foreign Studies.
- Shamsul Amri Baharuddin. (2011). *Kesepaduan dalam Kepelbagaian: Perpaduan di Malaysia sebagai work-in progress*. Bangi: Penerbit Universiti Kebangsaan Malaysia.
- Suraya Sintang, Budi Anto Mohd. Tamring, Nur Farhana Abdul Rahman, Siti Aidah Hj. Lukin & Halina Sendera Mohd. Yakin. (2019). Kesepaduan Sosial dalam Hubungan antara Agama di Pedalaman Sabah. *Borneo International Journal*, 2(1), 5-15.
- Suraya Sintang (2014). Peaceful co-existence in religious diversity in Sabah, Malaysia. *Global Journal of Human Social Science: Arts & Humanities – Psychology*, 14(1), 66-78.

ESTABLISH SPATIAL STATISTICS SYSTEM DESIGN FOR POVERTY RISK ESTIMATION

Siti Aisyah Nawawi

Universiti Malaysia Kelantan, 17700, Jeli, Kelantan
aisyah.n@umk.edu.my

Norashikin Mohd Fauzi¹, Amal Najihah Muhamad Nor¹, Norfadhilah Ibrahim¹, Rohazaini Muhammad Jamil¹, Siti Hajar Ya'acob¹, Wan Nur Fazni Wan Mohamad Nazarie², Rabihah Nawawi³

¹Universiti Malaysia Kelantan, 17700, Jeli, Kelantan

²Universiti Sains Islam Malaysia, 71800 Nilai Seremban.

³UiTM Cawangan Kota Bharu, Kota Bharu Kelantan.

ashikin@umk.edu.my, amalnajihah@umk.edu.my, nfadhilah@umk.edu.my, rohazaini@umk.edu.my,
hajar.y@umk.edu.my, fazni@usim.edu.my, rabihah92@uitm.edu.my

Highlights: A Poisson log-linear Leroux Conditional Autoregressive model with different neighbourhood weight matrices will be applied to the poverty data to estimate the relative risk of poverty. This estimation allows for the identification of high-risk and low-risk poverty areas. In addition, this method will determine the covariates that significantly contribute to poverty.

Keywords: *Conditional Autoregressive model, neighbourhood weight matrices, relative risk, poverty*

Introduction

Poverty has an impact on economic development, children's development, health, and violence. This study aim is to estimate the poverty risk. Thus the spatial pattern of poverty can be examined. The objectives of this study are to integrate a Poisson log-linear model and the Leroux Conditional Autoregressive model with neighbourhood matrices to predict the relative risk of poverty and determine the potential covariates that contribute to poverty. Household Income and Basic Amenities Survey Report, 2016 by the Department of Statistics Malaysia (DOSM) revealed that Kelantan has the highest incidence of poverty compared to other states in Peninsular Malaysia. In addition, the Unit Perancang Ekonomi Negeri Kelantan (UPEN) informed that Tumpat has the highest number of poor household heads, followed by Bachok, Pasir Mas, Tanah Merah and other districts. This show that areas located on the international and coastal borders are more likely to be poor. However, an area cannot be considered a high-risk poverty area according to the high number of poor household heads as it is likely to happen if the population is large. Thus, to overcome this problem, a spatial statistics system design is adopted.

Content

The response variable of poverty data is the number of poor households counts for each district typically displaying spatial dependence, with observations from areal units close together tending to have similar values than further apart. In spatial analysis, identifying the neighbourhood structure of the data being analysed is essential when conducting tests for autocorrelation data and modelling data at the areal level. A Poisson log-linear Leroux CAR model with contiguity and Delaunay triangulation neighbourhood matrices are fitted to the simulated and real poverty data. A simulation study with different scenarios related to random effects and covariate is conducted. At the same time, the real poverty data for 66 districts of Kelantan are obtained from the e-Kasih database from the Ministry of Women, Family and Community Development. A small number of covariates, which are the demographic characteristics of poor household heads, are available to describe the spatial variation in poverty risk across all districts in Kelantan. The performance of the Poisson log-linear Leroux CAR model with different neighbourhood weight matrices is compared using the deviance information criterion (DIC). Figure 1 shows the methodological framework used in this study.

The Poisson log-linear Leroux CAR model with contiguity and Delaunay triangulation is proved to perform well in simulation and real data. The estimated poverty risk map represents the spatial pattern of poverty risk for 66 districts in Kelantan. The value of risk greater than one show the high-risk area. More areas exhibit elevated risks than decreased poverty risks. Furthermore, the model also highlights the effects of the covariates on poverty. Table 1 shows convincing evidence that a decrease in age, increase in non-formal education and increase in the poor female head of household contribute to an increased risk of poverty in an area. The output from this study can help the authority identify high-risk areas of poverty at a low cost. Furthermore, it assists the authority in identifying the characteristics of the poor head of the household who should be prioritised for support. As a result, the poverty risk in 66 districts in Kelantan can be eradicated.

Figure 1: Methodological Framework

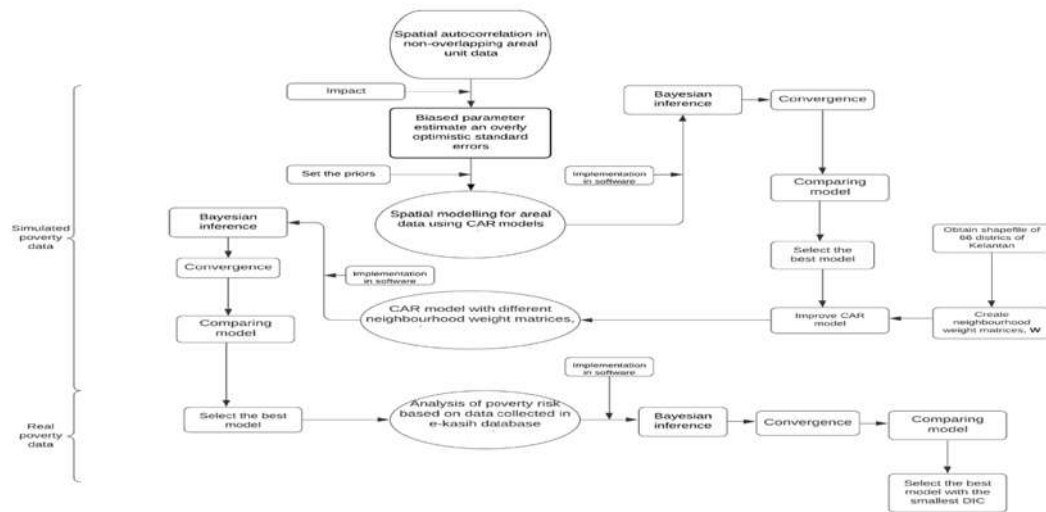

Table 1: Model evaluation

Model	Variable	Relative risk	95% credible interval	DIC
Contiguity	Age	0.936	(0.908, 0.966)	550.623
	Log Female	1.313	(1.273, 1.358)	
	No-education	1.148	(1.089, 1.202)	
Delaunay	Age	0.936	(0.908, 0.966)	550.353
	Log Female	1.313	(1.273, 1.358)	
	No-education	1.148	(1.089, 1.202)	

Acknowledgement

The authors are grateful for the assistance received from the Faculty of Earth Science, UMK Jeli Campus, Ministry of Women, Family and Community Development and Yayasan Maghfirah.

References

- Lee, D. (2011), 'A comparison of conditional autoregressive models used in bayesian disease mapping', *Spatial and Spatio-temporal Epidemiology* 2(2), 79–89.
- Nawawi, S. A., Busu, I., Fauzi, N., Amin, M. F. M., & Yusof, N. R. N. (2020, August). Relative Risk for Poverty in Kelantan—A Bayesian Approach. In *IOP Conference Series: Earth and Environmental Science* (Vol. 549, No. 1, p. 012079). IOP Publishing.
- Aisyah Nawawi, S., Busu, I., Fauzi, N., & Amin, M. F. M. (2020). Analysis of spatial determinants of poverty in Kelantan. *Journal of Tropical Resources and Sustainable Science*.

BIBLIOMETRIC: JURIMETRICS TO DETERMINE REFERENCES ON LEGAL CASES IN MALAYSIA

Adi Aizat Yajid

Universiti Malaysia Kelantan, Pengkalan Chepa, Malaysia
adiaizat@umk.edu.my

Abdul Khabir Rahmat¹, Ahmad Ridhuan Abdullah², Nur Syafiqah A. Samad², Norzalizah Bahari², Siti Fariha Muhamad²

¹Universiti Teknologi MARA, Shah Alam, Malaysia

²Universiti Malaysia Kelantan, Pengkalan Chepa, Malaysia

abdulkhabir@uitm.edu.my, ridhuan.a@umk.edu.my, nursyafiqah.as@umk.edu.my,
norzalizah.b@umk.edu.my, fariha@umk.edu.my

Highlights: Jurimetrics, a social science method that attempts to measure those aspects of justice, which is empirical in nature. It applies the quantitative measures to law, including statistical data. Although it is yet to be used widely, but it is recognised for its importance to the field. Using bibliometric analysis as part of jurimetrics, it able to provide statistical data, which could assist legal field, including education aspect, to understand and decide a more accurate references on a given case, through analysis of collections of documented court cases.

Key words: *Bibliometric analysis, Jurimetrics, Legal studies, Judicial precedent, Stare decisis*

Introduction

Similar to other fields, references are vital in every aspect of the legal discipline, be it for the purpose of enforcement, decision of the courts, or even in the education branch of it. Court cases, statutes, academic writings and other legal documents are documented to be used as future references, among others, for the developments of the said body of knowledge. Throughout the years, the creativity of human has pushed law discipline to become more creative in the context of, but not limited to, enforcement and analysis. Such pressure has made legal field to look into various other discipline for assistance, thus employing various non-doctrinal legal studies, including statistical analysis on legal matters. The value of references has become more important as consistency over decision of law is very much sort after, all the time.

Content

Statistical analysis in legal field, especially on the documents, even though is not something which is new, but is hardly used. With numerous decisions of the courts take place every single day, add on with the creativity of offenses committed by various parties, the developments of legal knowledge are a must. With its strong origin of subjectivity, assistance from quantitative measure and studies could not be denied, if consistency and accuracy of decision want to be achieved. With numerous available writings and research on law, measuring output of such documents able to provide legal field, not only statistical analysis, but beyond that as per suggested through bibliometric analysis.

Statistical data and analysis in legal field is yet to be used widely in Malaysia, even though the benefits could be very clear, for example to determine whether the reference case used is the one that is being considered as the leading case, based on the number of times its being referred to. The subjectivity of such move, due to the discretion power granted to the judges, makes references to cases rather vast in terms of its grasp. By having limited quantitative legal data and analysis on the usage of reference cases in courts' decisions, it is a set of challenge for the law as to match leading cases and current scenario, which might not be the concerns through previous instances. Whether unavailability of statistical data upholds judges' discretionary power or vice versa, dependency over statistical data become more relevant and needed in numerous fields, including legal field. The usage of bibliometric able to offer legal fraternity a more consistent practices as what should be referred to, what are the common practices and indirectly, it able to ensure the precision over legal practices, throughout the legal field. Although critics on decision through popularism might be rose as to such move, but, the usage of bibliometric able to provide stability in terms of references applied and referred to for future cases and legal issues, ensuring the principle of judicial precedent and stare decisis, among others, could be uphold in a more precise manner.

With legal studies focus more on doctrinal legal studies, which emphasize on leaning heavily only on legal documents qualitative analysis to solve legal matters, emphasize on non-doctrinal legal studies is yet to take place in Malaysia. It leaves a gap on studies that able to gain data based on quantitative approach. This particular gap, that being left behind by the qualitative-driven doctrinal studies, is an area that is no less important to the discipline. With analysis on legal references and documents able to provide information with regards to the pattern of reference by practitioners, most referred references to render them to be leading case or references, at the very least, this should be the next move for legal discipline, as they able to make legal education more accurate to the real practice.

Empowerment on knowledge is a must when it comes to education, and expanding the horizon of knowledge is very much needed. Looking into the values that bibliometric analysis able to provide, analysis of legal document, especially courts cases able to make legal studies more objectified as compared to before, without shrinking the importance of subjectivity to the field. Numerical data as to repetition of references use and terminological developments, among others, able to enhance the understanding of law students, which varies in numerous perspectives. It able to enhance the ability of understanding over rationale of any selection of legal references, which at the end, increase the accuracy and stability of legal decisions, throughout the discipline, be it education-wise or practice-wise.

It is indeed true that society might not have access to every single legal case that took place, even within Malaysia. Extending such situation, understanding of law, which very related to the access of legal information, is very much affected due to such circumstance. Which law should be looked into and which reference should be part of a case is everybody's guess, except for legal fraternities. Thus, by having statistical data from previous used cases and legal references able to provide much needed understanding of law towards the society. It might be one of the solutions for misinterpretation and misleading accusation of law, which occurred quite frequent in the era where social media is more powerful than mass media.

References

- Choudhri, A. F. et. al. (2015). Understanding Bibliometric Parameters and Analysis, *Radio Graphics*, 35(3).
<https://doi.org/10.1148/rg.2015140036>
- Garner, B. A. (2011). *A dictionary of modern legal usage*. Oxford University Press.
- Loevinger, L. (1963). Jurimetrics: The Methodology Of Legal Inquiry, *Law and Contemporary Problems*, 28(1).
<https://scholarship.law.duke.edu/lcp/vol28/iss1/2>

A MODELING STUDY OF THE ECONOMIC EMPOWERMENT OF WOMEN IN THE FIELD OF ENTREPRENEURSHIP IN KELANTAN

Zaleha Embong

Fakulti Pengajian Bahasa dan Pembangunan Insan
Universiti Malaysia Kelantan, Bachok, Kelantan
zaleha.e@umk.edu.my

Fairuz A'dilah Rusdi, Asma Lailee Mohd Noor, Wan Ahmad Amir Zal Wan Ismail

Fakulti Pengajian Bahasa dan Pembangunan Insan, Universiti Malaysia Kelantan, Bachok, Kelantan
fairuz@umk.edu.my, lailee@umk.edu.my, wqamirzal@umk.edu.my

Highlights: Women's involvement in business has been growing and thriving. This has a positive impact on the country's economy; and the success of these women has opened the eyes of many about the ability of women entrepreneurs in empowering the country's economy. The effort and perseverance in running a business proves the strong nature of women because the field of business has various challenges and obstacles. In Kelantan, women are synonymous with entrepreneurship and have achieved many successes. Therefore, this study aims to identify the driving factors, successes and failures of women entrepreneurs in business in the state of Kelantan. This study also examines the policies and principles of the government as well as NGOs in providing assistance to the women entrepreneurs in Kelantan. A mixture of quantitative and qualitative methods was incorporated in collecting the required data. Quantitative methods by using questionnaires was used and distributed to 300 respondents (N=300) of Kelantan women entrepreneurs. The data analysis was done using Statistical Package for the Social Sciences (SPSS) software. For the qualitative method, in-depth interviews was conducted with 11 women entrepreneurs and analyzed using content analysis. Findings show that among the motivating factors for women entrepreneurs to get involved in business included, wanting to change the economic status of the family, personal interests in business, to support and assist spouse's financial situation and inherit the family business. Among the success factors of women entrepreneurs found in this study comprised of deep interest, prudent planning, business knowledge and the willingness to take risks. It was due to these factors that led countless women entrepreneurs in Kelantan attain success. On the other hand, high competition and initiating a business without extensive knowledge and experience were key aspects in the failure of women in this field. Findings also found that women entrepreneurs made use of their own capital without assistance from any parties upon starting a business.

Key words: *Modeling, Empowerment, Economics, Women, Business*

Introduction

Business is one of the areas that can generate lucrative profits, contribute to increasing per capita income, and even act as a mechanism for change to the social structure of society with the ability to create employment opportunities while being able to reduce poverty (Isma Addi & Mohamad Zahir, 2011 ; Rahmah, 2012; Rosman & Mohd Rosli, 2011; Suhaila et al., 2014). Therefore, the field of entrepreneurship is seen to be able to provide a positive impact in the country's economic development.

The economic success of entrepreneurs depends a lot on their own efforts and skills even though there are many forms of support from the government. Entrepreneurial culture will produce creative entrepreneurs in finding solutions to any problems faced. Women entrepreneurs can play an important role in promoting sustainable practices in the economy, social and ecological systems to achieve sustainable development (Kalpana, 2016).

Now, there are many opportunities to start new businesses and international support for women entrepreneurs. Women-run enterprises continue to grow around the world which has contributed to the nation's household income and economic growth. However, women face time, physical and social constraints that limit their ability to grow their businesses (Anis Solehin Hussain @ Othman & Sharifah Rohayah Sheikh Dawood, 2020).

In the context of Kelantan, Anis Solehin Hussain @ Othman & Sharifah Rohayah Sheikh Dawood (2020) and Zamzuraidah Ismail's (2004) study showed that many women in Kelantan have ventured into the field of entrepreneurship and achieved remarkable success. Norshabiha Ibrahim and Sharifah Rohayah Sheikh Dawood (2020) studied the uniqueness of Kelantan women business culture in sustaining their business for generations. The uniqueness of different cultures includes attitudes, ways of doing business, and aspects that are emphasized in business to be able to survive despite the various economic problems of the country. This shows the persistence of women in venturing into business. This positive development shows that women are trying to improve their quality of life as well as help improve their economy. This study is significant to explore the driving factors and success of women in the field of entrepreneurship in Kelantan.

Content

1. Description of my project.

This study focuses on women who ventured into business and are seen to have potential in developing the economy of society and the country. This study aims to identify the driving factors of women's involvement in the field of entrepreneurship in Kelantan. In addition, this study also examines the factors of failures and successes of women in the field of entrepreneurship in Kelantan. In addition, this study also looks at the strategies and policies of the government and NGOs in helping women entrepreneurs in Kelantan and then build a model of empowerment of women entrepreneurs in Kelantan.

2. Context or background of the project

The background of this project was based on women entrepreneurs, focusing on the successes and failures of women in business in Kelantan.

3. The importance of this project

This study is important to identify the success and failure factors of women entrepreneurs in Kelantan. In addition, this study also aims to determine the role of women entrepreneurs in the economic development of society, the country and examine the creativity and strategies of women entrepreneurs in growing businesses.

4. Advantages of this project towards education and community.

This study can open space for women to know in detail the success and failure factors of women entrepreneurs. This can help women entrepreneurs to set strategies for starting a business. This study can also contribute to the knowledge of social entrepreneurship which involves women who are diligent in improving the standard of economic quality and help the local community generate side income.

5. Commercial value in terms of marketability or profitability of the project.

This study is important as a contribution of knowledge in terms of women entrepreneurship and business strategies that affect the group of women entrepreneurs to continue to thrive. This study can help women entrepreneurs in planning and growing their businesses to be more competitive.

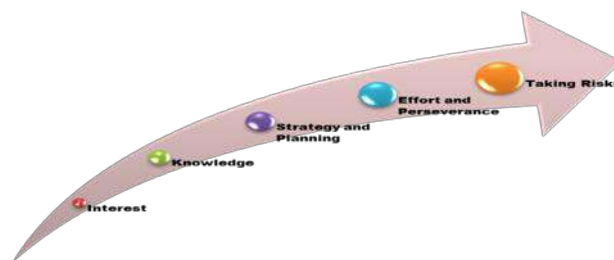

Figure 1: Kelantan Women's Entrepreneur Empowerment Model

Acknowledgement

This study is the result of a research grant. Special thanks to Universiti Malaysia Kelantan (UMK) whom have sponsored this research under the Short Term Research Grant Scheme, IMPAK (Grant no.: R/SGJP/A0400/01558A/002/2019/00681) for the year 2019.

References

- Anis Solehin Hussain @ Othman & Sharifah Rohayah Sheikh Dawood (2020). Keusahawanan Wanita di Kelantan Berteraskan Model Ekonomi Baru: Hala Tuju dan Cabaran. *Journal of Social Science and Humanities*, 17(4), 124-148.
- Isma Addi Jumbri, Mohamad Zahir Zainudin (2011). Pembangunan Modal Insan dalam Kalangan Fakir dan Miskin Sebagai Usahawan: Kajian Kes di Lembaga Zakat Selangor. *Journal of Human Capital Development* 4(2), 41-56.
- Kalpna R, Ambepitiya. (2016). The Role of women Entrepreneurs in Establishing Sustainable Development in Developing Nations. *World Review of Business Research*, 6, 161-178.
- Norshabiha Ibrahim & Sharifah Rohayah Sheikh Dawood (2020). Keunikan Budaya Berniaga Wanita Kelantan di Bandar Kota Bharu. *Journal of Social Science and Humanities*, 17(1), 93-107.
- Rahmah Ismail (2012). *Modal Manusia dalam Pembangunan Ekonomi Memacu Produktiviti dan Daya Saing*. Universiti Kebangsaan Malaysia, Bangi.
- Rosman Mahmood, Mohd Rosli Mohamad (2011). *Perusahaan Kecil dan Dilema Usahawan Melayu*. Penerbit Universiti Malaya, Kuala Lumpur.

FUTURE HOMES: INTEGRATION ELEMENT OF A HEALTHY HOME AND SMART SYSTEM TO ENHANCE WELLBEING FOR ALL

Siti Nurafirah bt Che Mohd Nasir

Universiti Malaysia Kelantan, Bachok, Malaysia
Nurafirah.mn@umk.edu.my

Salmiah bt Aziz, Nur 'Izzati bt Mohd Amin, Dr WaOmar Ali Saifuddin b Wan Ismail

Universiti Malaysia Kelantan, Bachok, Malaysia
Universiti Sultan Zainal Abidin, Kuala Terengganu, Malaysia
Salmiah.a@umk.edu.my, Izzati.ma@umk.edu.my, woasaifuddin@unisza.edu.my

Highlights: Housing is more than shelter or the physical structure. A more descriptive term is the residential environment, which is defined by the World Health Organization (WHO) who are expert committee on the public health aspects of housing as a 'The physical structure that man uses for shelter and the environs of that structure including all necessary services, facilities equipment and devices needed or desired for the physical and mental health and social well-being of the family and the individual'.

Key words: *healthy home, smart system, future homes, elements of healthy home, wellbeing.*

Introduction

According to the National Center for Healthy Housing (NCHH), a healthy home is housing that is designed, constructed, maintained, and rehabilitated in a manner that is conducive to good occupant health. Our housing and our health are at once inseparable and distinct. Together, they reflect two of our most basic needs for individual and collective identity, privacy, social progress and indeed survival itself. Nevertheless, the fact that improved housing means improved health in a general way has been accepted for well over a century.

A collection of data analysed in this research is gained through literature review from other authors in the aspect of healthy home, technology, smart system, Internet of Things (IoT) and smart home technology in Malaysia. Secondary data, such as books, articles, journals, newspapers, web page, reports, thesis, and conference proceeding were also the sources of information of this paper. The review process involves of data selection, data analysis and reporting. Review process focuses on the data selection. The analysis attempts to review on presenting the existing knowledge related to the use of IoT for smart home in Malaysia context, current issues, problems faced amongst Malaysians on smart home technology integrating with elements of healthy housing. The objective of this research is to propose a basic guideline that applicable for Future Homes: Integration element of a Healthy Home with Smart System to enhance wellbeing for all.

There are a few elements that most related to healthy homes which are structure / interior material & finishes, ventilation, cleanliness, safety and security, facilities, lifestyle and also water system.

This research plays a vital social role, assisting our government and businesses to develop services, policies, and economies as well as community health that are responsive to an identified need. It contributes to Malaysia economic wellbeing, by ensuring that people health to these needs are relevant and properly manage and identified. Consumers of market and social research include State and Federal government agencies, companies and non-government organisations in fact; any organisation that needs to better understand the community about healthy home environments integrating with smart home system towards healthy living, injuries and disease free, or relevance will use this research. Construction industry players play important roles in housing construction in Malaysia. There are architects, NGO, scientist, contractor, supplier, developer, interior designer, landscape designer, quantify surveyor, building surveyor and many more. This research may help them to improve our quality of life through living inside healthy home environment.

The idea of a smart home is getting attention for the last few years. The key challenges in a smart home are intelligent decision making, secure identification, and authentication of the IoT devices, continuous connectivity, data security, and privacy issues. The existing systems are targeting one or two of these issues whereas a smart home automation system that is not only secure but also has intelligent decision making and analytical abilities is the need of time (Ridzwan Majeed et al, 2020). In the actual era of smart homes and smart grids, advanced technological systems that allow the automation of domestic tasks are developing rapidly. There are numerous technologies and applications that can be installed in smart homes today. They enable communication between home appliances and users, and enhance home appliances' automation, monitoring and remote-control capabilities. This research, by introducing the concept of the smart home and the advent of the smart grid, investigates technologies for smart homes.

Moreover, home Automation (HA) provides an intelligent interface that monitors and learns the users' habits and might anticipate and facilitate their movements. HA can make life easier and more comfortable or provide some energy efficiency savings by interacting with users remotely [82]. HA provides part of the system for managing the smart home. However, the HA system would need to be combined with non-automated devices for user interaction. For example, using only HA systems would not provide users with the ability to adjust their energy usage. But provided that, feedback is given to end-users based on the control activities performed as part of the smart home automation system. Such technology could well be included into an intelligent system that saves energy and improves thermal and visual comfort in the home by implementing both short-term and long-term thermal and visual discomfort indices.

As an important component of the Internet of Things (IoT), smart homes serve users effectively by communicating with various digital devices based on IoT. In the ideal version of a wired future, all devices in smart homes communicate with one another seamlessly. Smart home technology based on IoT has changed human life by providing connectivity to everyone regardless of time and place. Home automation systems have become increasingly sophisticated in recent years. These systems provide infrastructure and methods to exchange all types of appliance information and services. A smart home is a domain of IoT, which is the network of physical devices that provide electronic, sensor, software, and network connectivity inside a home. Smart homes are automated buildings with installed detection and control devices, such as air conditioning and heating, ventilation, lighting, hardware, and security systems. These modern systems, which include switches and sensors that communicate with a central axis, are sometimes called "gateways." These "gateways" are control systems with a user interface that interacts with a tablet, mobile phone, or computer; the network connectivity of these systems is managed by IoT. Since 2010, researchers have analyzed IoT-based smart home applications using several approaches. Regardless of their category, existing research articles focus on the challenges that hinder the full utilization of smart home IoT applications and provide recommendations to mitigate these problems. Research on smart home applications is dynamic and diverse (Wood, L. 2019).

As we continue to deal with the current pandemic and all of its ripple effects, it is recommend taking the time to make some observation towards this guideline in order to make our life and well-being healthier as well as maximize the comfort level of your home. Being able to live and work in a comfortable home is a great way to alleviate the stress from everything else going on in the world. Thus, this framework will go through the process in order to commercial it through future research, proper R&D, copyright as well as into intellectual property and compile it accordingly.

Acknowledgement

The authors would like to express appreciation to the Research Management & Innovation Centre of Universiti Malaysia Kelantan, who funded this project through UMK fundamental research grant (UMK-FUND) 2020 entitled Healthy Home Using an Intelligent System to Enhance Habitants Social Interaction code no R/fund/a1200/01675a/002/2020/00851. Thank you for their support and providing facilities that enable us to conduct this studies and getting it published.

References

- 8 elements of a green and healthy home. (2019). Retrieved from Green & Healthy Homes Initiative : <https://www.greenandhealthyhomes.org/home-and-health/elements-green-healthy-home/>
- Alter, L. (6 September, 2016). What is a "Healthy" home? Retrieved from Tree Hugger: <https://www.treehugger.com/green-architecture/what-healthy-home.html>
- Aziz, S., Che Mohd Nasir, S.N. (2020). Issues and Challenges for Research in Adoption IoT and Latest Technology for Home Building. International Conference On Design Innovation, Social Science & Technology (p. 3). Malaysia: Center of Excellence Geopolymer and Green Technology, Universiti Malaysia Perlis.
- Che Mohd Nasir, S.N., Aziz, S. (2020). Information On Creating A Healthy Home Environment In Malaysia. International Conference On Design Innovation, Social Science & Technology (p. 5). Malaysia: Center of Excellence Geopolymer and Green Technology, Universiti Malaysia Perlis.
- Ficher, U. (2017, February 20). Malaysia Leverages on Internet of Things. Retrieved August 30, 2020, from Malaysia Insights: <https://www.malaysia-insights.com/malaysia-leverages-on-internet-of-things/>
- Foundation, M. (October, 2017). Mind Foundation. Retrieved from Clean Living Means Having a Healthy Home Environment: <https://mindd.org/healthy-home-environment/>.
- Healthy Homes and Environment. (2016). Retrieved from Boston of Public Health Commission: <http://www.bphc.org/whatwedo/healthy-homes-environment/Pages/Healthy-Homes-and-Environment.aspx>. New York State. (2018). Retrieved from Seven Principles of Healthy Homes: https://www.health.ny.gov/environmental/indoors/healthy_homes/seven_principles.htm.
- <https://www.bustle.com/articles/171847-11-ways-to-make-your-home-more-healthy-because-your-environment-matters-too> Winnie Ong. (2020, June 16). The Star.com. Retrieved January 15, 2021, from The other, quieter, health crisis in Malaysia: <https://www.thestar.com.my/opinion/letters/2020/06/16/the-other-quieter-health-crisis-in-malaysia>
- Noise. (2020, April 24). Retrieved from Passive Design: <http://www.level.org.nz/passive-design/controlling-noise/>. Science Engineering Medicine. (2015). Retrieved from Healthy, Resilient, and Sustainable Communities After Disasters: Strategies, Opportunities, and Planning for Recovery: <https://www.nap.edu/read/18996/chapter/15>
- The Principles of a Healthy Home. (2020). Retrieved from National Centre for Healthy Housing: <https://nchh.org/information-and-evidence/learn-about-healthy-housing/healthy-homes-principles/>
- What is a Healthy Home? (2018). Retrieved from Healthy Homes: <http://www.healthyhomescoalition.org/what-is-a-healthy-home>.
- Windpassinger, N. (2018, November 12). Smart Homes: When Interior Design Meets the Internet of Things (guest blog). Retrieved July 13, 2020, from Nicolas Windpassinger: <https://nicolaswindpassinger.com/smart-homes-when-interior-design-meets-the-internet-of-things>
- Wood, L. (2019, December 11). Malaysia Smart Home Market Report 2019-2025: Number, Household Penetration & Key Company Analysis - ResearchAndMarkets.com. Retrieved August 30, 2020, from <https://www.businesswire.com/news/home/20191211005823/en/Malaysia-Smart-Home-Market-Report-2019-2025-Number>
- Wolff, C. (12 July, 2016). 11 Ways to Make Your Home Healthier, Because Your Environment Matters Too. Retrieved from Bustle:
- Zulkafli, M. N. (2020, April 8). Hello Doktor. Retrieved from Rumah Kotor. Anda Mungkin Berisiko Untuk Menyebarkan COVID-19: <https://helloworldoktor.com/ms/coronavirus/covid19/kebersihan-rumah-covid19/#gref>

DEVELOPMENT OF A MODERATED FINANCIAL STRAIN MODEL AMONG HOMEOWNERS WITH THE JOB SATISFACTION-DEBT BEHAVIOUR INTERACTION

Husniyah A. Rahim

Universiti Putra Malaysia, Serdang, Malaysia
husniyah@upm.edu.my

Zahariah Sahudin¹, Amirah Shazana Magli¹, Mohd. Fazli Sabri¹, Mohd. Amim Othman²

¹Universiti Putra Malaysia, Serdang, Malaysia; ²Universiti Teknologi MARA, Shah Alam, Malaysia
zahariah128@uitm.edu.my, amirahshazana90@gmail.com, fazli@upm.edu.my, mohdamim@gmail.com

Highlights: A multi-stage random sampling targeting 400 employees who are homeowners resulted in 322 usable questionnaires. Hierarchical regression was used to develop a moderated financial strain model having the job satisfaction-debt behaviour interaction. Influential predictors were debt behaviour followed by financial event, locus of control and job satisfaction. Hence, employees should focus on managing debt well as it results in financial strain. Employers should also ensure high job satisfaction among employees to overcome the effect of poor debt behaviour on financial strain. The disengagement from work may surfaced resulting in reduced job productivity.

Key words: *debt behaviour, event, financial strain, job satisfaction, locus control, repayment*

Introduction

Households are experiencing high debt load that may jeopardise their well-being. The non-performing loan for consumer durable goods is shown to increase above RM2 billion in 2021 (Bank Negara Malaysia, 2021). Past studies showed positive relationships between household debt and financial problem (French & McKillop, 2017). Hence, the amount of debt possessed may differentiate the outcome of financial strain. Financial strain was reported to result in negative consequences such as suicide attempts (Elbogen et al., 2021) and work stress (Bhui et al., 2016).

As the consequences of financial strain are detrimental to well-being, it is critical to assess the predictors. This study aims to develop a moderated financial strain model having the interaction of job satisfaction with debt behaviour. The model was controlled by personal and behavioural factors namely external locus of control, financial event and mortgage-debt-repayment ratio. It is supported by the Expected Utility Theory stating that any actions taken depend on the perception of the utility gained. Past studies provided proof for the effect by the predictors on financial strain including a recent work revealing a significant relation between work satisfaction and financial strain (To et al., 2020). However, none was found regarding job satisfaction's moderation effect in the influence of debt behaviour on financial strain.

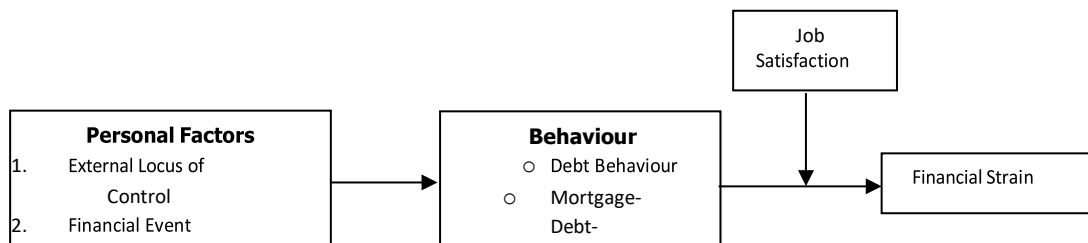

Figure 1: Moderated financial strain model

Research Methodology

A multi-stage random sampling was utilised to sample civil sector employees' homeowners, specifically chosen to control the income risk. Having a steady income enables them to repay loan according to the Permanent Income Hypothesis. A sample size of 382 is required (95% confidence; $\pm 5\%$ margin error) (Dillman, 2000) for a 1.4 million Public Services Department workers (Human Resource Management Information System, 2013). A total of 400 respondents in Peninsular Malaysia were randomly chosen from each department through a list of names by liaison officers however only 322 completed self-administered questionnaires were obtained. The sample is adequate for multivariate regression analysis where a minimum sample size required is 98 (formula is $n = 50 + 8*m$ (m is the number of independent variables)) (Tabachnick and Fidell, 2019).

Validation of the measurements were based on content validity and face validity; and the reliability of the measurements were assessed using Cronbach Alpha statistic. The alpha values ranged from 0.6 to 0.9 representing reliable measurements. Content validity of the measurements were confirmed by using established measurements from past studies. Assessment of face validity for the measurements were done during the pilot study. Financial strain was operationalised as the degree of difficulty in fulfilling financial obligations (Falahati, 2012). Debt behaviour referred to the extent of debt involvement.

Results

Hierarchical multiple regressions confirmed the moderating effect of job satisfaction in the influence of debt behaviour on financial strain. Influential predictors were debt behaviour, financial event, external locus of control and job satisfaction. Mortgage-debt-repayment ratio was insignificant in influencing financial strain with the inclusion of job satisfaction. Thus, job satisfaction is important to diminish the effect of poor debt behaviour in elevating financial strain. Though having poor debt behaviour, by being more satisfied with their job, financial strain would be reduced. Thus, leading to a better well-being and higher job productivity. Prediction of financial strain can be made using this financial strain moderated model:

$$\text{Financial strain} = 2.268 + .426 \text{ External locus control} + .932 \text{ Mortgage-debt-repayment ratio} + .763 \text{ Debt behaviour} + .418 \text{ Financial event} - .448 \text{ Job satisfaction} - 1.025 \text{ Debt behaviour} \times \text{job satisfaction}$$

Table 1: Multiple regression for financial strain

	Model	B	Beta	t	p
1	External locus control	.318	.097	2.130*	.034
	Mortgage-debt-repayment ratio	1.398	.087	2.047*	.042
	Debt behaviour	.884	.655	13.939**	.000
	Financial event	.377	.200	4.398**	.000
2	Constant	2.268			
	External locus control	.426	.129	2.989**	.003
	Mortgage-debt-repayment ratio	.932	.058	1.447	.149
	Debt behaviour	.763	.565	11.826**	.000
	Financial event	.418	.222	5.178**	.000
	Job satisfaction	-.448	-.123	-3.090**	.002
	Debt behaviour \times job satisfaction	-1.025	-.191	-4.442**	.000

DV: Financial strain; R² 64% & 69% respectively
 **p < 0.01; *p < 0.05

Conclusion

A moderated financial strain model by job satisfaction was developed having debt behaviour as an important predictor of the employees' financial strain. This moderated financial strain model having the debt behaviour-job satisfaction is a contribution to the body of knowledge. Poor debt behaviour, externally locus control and negative financial events lead to more financial strain, but with higher job satisfaction, the feeling of financial strain will lessen. Hence, managing debt well should be the focus of the employees. Employers should ensure high job satisfaction to overcome the effect of poor debt behaviour on the financial strain. The results of the model development enabled an action plan to be drafted by employers and education providers to enhance employees and community well-being. It is able to predict financial strain by knowing their personal factors and this assists in identifying the target group for financial education. The action would help to achieve Goal 8 of SDG regarding access to decent work and Goal 3 related to advancing well-being.

Employers can develop an intervention program namely a debt management program tailored to the need of their employees based on the levels of the factors studied; or seeking help from debt management agencies to deliver debt management program, such as by AKPK (Agensi Kaunseling & Pengurusan Kredit). Ignoring the actions to overcome poor debt behaviour and financial strain may impact job productivity. They would be disengaged from their work delivering low productivity.

Acknowledgement

We would like to thank Universiti Putra Malaysia for the Putra Grant Scheme fund with project number GP/2017/9572800.

References

- Bank Negara Malaysia (2021). Banking system: Classification of loans by type. Bank Negara Malaysia.
- Bhui, K., Dinos, S., Galant-Miecznikowska, M., de Jongh, B., & Stansfeld, S. (2016). Perceptions of work stress causes and effective interventions in employees working in public, private and non-governmental organisations: A qualitative study. *Journal of Psychological Bulletin*, 40(6), 318-325.
- Dillman, D.A. (2000). *Mail and internet surveys: The tailored design method*. Wiley.
- Elbogen, E.B., Lanier, M., Wagner, H.R., & Tsai, J. (2021). Financial strain, mental illness, and homelessness: Results from a national longitudinal study. *Medical Care*, 59, S132-S138.
- French, D. & McKillop, D. (2017). The impact of debt and financial stress on health in Northern Irish households. *Journal of European Social Policy*, 27(5), 458-473.
- Falahati, L., Sabri, M. F., & Paim, L. (2012). Assessment a model of financial satisfaction predictors: Examining the mediate effect of financial behaviour and financial strain. *World Applied Sciences Journal*, 20(2), 190-197.
- Tabachnick, B. G. & Fidell, L. S. (2019). *Using multivariate statistics (7rd ed.)*. Pearson Education, Inc.
- To, W.M., Gao, J.H., & Leung, E.Y.W. (2020). The effects of job insecurity on employees' financial well-being and work satisfaction among Chinese pink-collar workers. *SAGE Open*, October-December, 1-11.

USE ME HEALTH RECORD (UMHR)

Khairunisa Nasuha Ahmad Kamal

Politeknik Muadzam Shah, Pahang
nissaaahmd7763@gmail.com

Damia Nazifa Al Hashimi, Muhammad Akmal Hazim Fairusdzuddin & Afzanizam Alias

Politeknik Muadzam Shah, Pahang
damianazifa9482@gmail.com, akmalhazim9606@gmail.com

Highlights: Use Me Health Record (UMHR) was developed to meet the requirements of the new norm in Politeknik MUadzam Shah. UMHR is a complement to SOP improvements completed with database sets, Arduino IDE, RFID kits, scanners, 8266 node, MCU 8266 and phone devices. This prototype will trigger user and give feedback via WhatsApp to user and admin from the database collection when meet to requirement (HIGH TEMPERATURE). Student data and information are collected automatically and stored directly to the database for monitoring or record purposes.

Keywords: *new norm, IOT, monitoring*

Introduction

In year 2019, the whole world was shocked by a new virus known as corona virus or Covid-19 that can be spread through touch and air. The COVID-19 pandemic has caused chaos around the world. There were many infections and unfortunately many casualties. One of the most important measures recommended by the World Health Organization is to wash hands with soap or hand sanitizer. But one of the common problems is the attitude of users who always ignore the use of sanitizer by just passing the sanitizer before entering the premises or office, classroom and so on. It even poses a great risk of infection when users do not clean their hands and touch items or equipment. Therefore, to prevent this virus infection from spreading, we have created an automatic hand sanitizer called Use Me Health Record. This product works with RFID cards that are only used by polytechnic staff and students to use sanitizer. The purpose of this project is so that users can use the sanitizer easily before entering a place. The system was also developed to gradually reduce the point of contact of viruses that can spread through contact on goods or other objects. With advanced technology, this Use Me Health Record, can help the authorities to know the information of people who enter the polytechnic and how many people use sanitizer. (NurHayati, 2020)

Objectives

The objectives of the project are listed below :

1. To develop a product which can control of hand sanitizer, record the student/staff information
2. Trigger the temperature and notify admin via WhatsApp
3. Detect the student who have symptom (high temperature) & follow up

The importance of product

Contribution to institution/ community

1. Cater data management record for institution for student and staff
2. Follow SOP – Increase awareness among user when entering department
3. Turning point and motivation for implementation of hybrid product which focus on SOP and IOT technology.

The basic architecture

From the results of the survey, WhatsApp /Telegram show that 91.4% is the most frequent use application when they use their smartphone and the second highest is used for social networking resulting in 70% such as Facebook, Instagram and Twitter . UMHR is a complement to SOP improvements completed with database sets, Arduino IDE, RFID kits, scanners, 8266 node, MCU 8266 and phone devices. WhatsApp will trigger to admin/student when meet to requirement. It is supported by the research of Ahmad & Sarlan (2015).

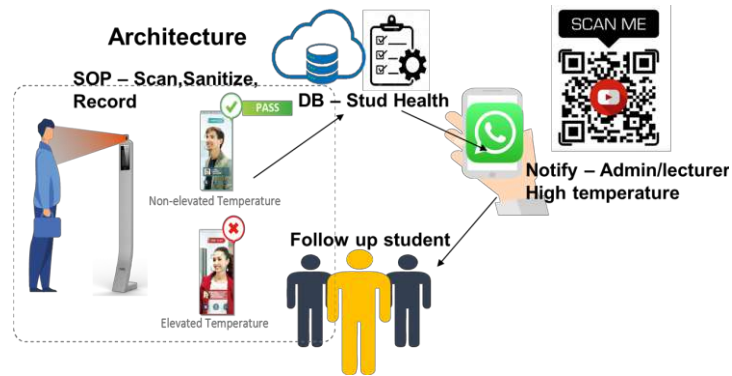

Entrepreneurial and Marketing Potential

The Use Me Health Record application has submitted for copyright. This prototype mentoring by Industry and PMS Alumni : Durian Tunggal Solution & RoboShop (Megateam Sdn Bhd). It will upgrade using CLOUD BASE application.

References

- Ahmad, W. F. W., & Sarlan, A. (2015). Akademia Baru The Barriers to Adoption of Mobile Learning by HEIs in Malaysia : An Exploratory Study Akademia Baru, 14(1), 1–9.
- Akshay Sharma A S. (2020). Review on Automatic Sanitizer Dispensing Machine. 17 July. <https://www.ijert.org/review-on-automatic-sanitizer-dispensing-machine>
- Mahesh T.Dubey. (2020). IoT based Automatic Hand Sanitizer Dispenser. 12 December. <https://www.irjet.net/archives/V7/I12/IRJET-V7I12317.pdf>
- Mission Critical. (2020). DIY Hand Sanitizer Dispenser Using Arduino.15 April. <https://create.arduino.cc/projecthub/MissionCritical/diy-hand-sanitizer-dispenser-using-arduino-143de1>
- NurHayati. (2020). Automatic Hand Sanitizer Container to Prevent the Spread of Corona Virus Disease. https://www.researchgate.net/publication/347400645_Automatic_Hand_Sanitizer_Container_to_Prevent_the_Spread_of_Corona_Virus_Disease/fulltext/5fe32a31a6fdccdc8f439c9/Automatic-Hand-Sanitizer-Container-to-Prevent-the-Spread-of-Corona-Virus-Disease.pdf?orig
- Young Jae Kim. (2020). Design of Automatic Hand Sanitizer System Compatible with Various Containers. 31 July. <https://www.ncbi.nlm.nih.gov/pmc/articles/PMC7438695/>

PRINCIPLES OF RESPONSIBILITY IN THE MEDINA CHARTER TO BUILD COOPERATIVE RELATIONS OF THE CROSS-CULTURAL SOCIETY

Zaleha Embong,

Fakulti Pengajian Bahasa dan Pembangunan Insan
Universiti Malaysia Kelantan, Bachok, Kelantan
zaleha.e@umk.edu.my

**Fairuz A'Dilah Rusdi¹, Asma Lailee Mohd Noor¹, Ateerah Abd Razak¹, Nik Yusri Musa¹, Nur Azuki Yusuff¹,
Noor Shakirah Mat Akhir², Nazri Muslim³**

¹Fakulti Pengajian Bahasa dan Pembangunan Insan, Universiti Malaysia Kelantan, Bachok, Kelantan, ²Pusat Pengajian Ilmu Kemanusiaan, Universiti Sains Malaysia, ³Pusat Pengajian Citra Universiti, Universiti Kebangsaan Malaysia

fairuz@umk.edu.my, lailee@umk.edu.my, ateerah@umk.edu.my,
nikyusri@umk.edu.my, nurazuki@umk.edu.my, shakirah@usm.my, nazrim@ukm.edu.my

Highlights: The Medina Charter is the world's first written constitution enacted by the Prophet Muhammad PBUH to manage the cross-cultural society in Yathrib (after the migration, Yathrib changed its name to Madinah al Munawwarah). The Yathrib community comprised of various ethnicities, languages, religions, and tribes. Before the arrival of Islam, Yathrib had no organised political system in place and its people lived in factions and sects. Its people were constantly in conflict due to the high levels of ethnocentrism, instigating fights and quarrels to occur even though due to only small matters. Thus, the Prophet PBUH drafted the Medina Charter to build cooperative relations within the cross-cultural society. This article aims to identify the principles of responsibility in the Constitution of Medina and analyse the principles of responsibility in building cooperative relationships of cross-cultural communities in Medina. Qualitative methods i.e. in-depth interviews and (systematic) literature review or library research was used for this study. In analysing the data, content analysis method was employed. The results found that this Charter has laid down the principle of responsibility to be followed by every individual for the common good and has succeeded in uniting and fostering cooperative relations within the cross-cultural community of Medina.

Key words: *Principles of Responsibility, Medina Charter, Cooperation Relations, Cross-Cultural Society*

Introduction

The principle of responsibility is an important principle in human life. Therefore, the principle of responsibility has been much discussed. According to S. Abul A'la Maududi (1995), human beings are given the responsibility to prosper the earth. Therefore, Allah SWT recognizes human beings as caliphs to do good deeds and stay away from evil as well as form human beings who are obedient to Allah SWT (Hamka, 2006; Khairul Azmi Mohamad & Nooraini, 2009). Every action taken by human beings will be held accountable in the hereafter (Abdullah Ahmad Qodiry Al-Ahdal, 2003). According to O. P. Simorangkir (1987), responsibility means taking good care of everything around and being willing to do anything. Responsibility must be exercised towards oneself, society, religion and country. Thus, Islam places the responsibility on Muslims to implement Islamic law, especially justice for the well-being and harmony of all human beings (Wan Z. Kamaruddin Wan Ali & Ahmad Zuhdi, t.t.). The history of Islam proves the success of the Prophet PBUH in forming a cooperative relationship in the plural society in Medina. The Prophet PBUH had entered into an agreement with the non-Muslim community through the Medina Charter (Saari Sungib, 2012; Munir Muhammad Al-Ghadban, 2003). According to Yahaya Jusoh (2014), the Clauses in the Medina Charter is an effort to unite the plural society in Medina. The Prophet PBUH built the Islamic state of Medina based on the Welfare State, which is centered on the word monotheism and built cooperative relations with non-Muslims. Meanwhile, Guillaume (2004) argues that the Medina Charter emphasizes coexistence between the Muhajirin and the Ansar as well as the Jews. As a result, the people of Medina respect each other, protect property rights and have the principle of responsibility to defend Medina.

Content

1. Description of my project.

This study focuses on the implementation of the principles of responsibility contained in the Medina Charter. This charter was drafted by Muhammad PBUH in managing the cross-cultural community in Medina. The Medina Charter is the world's first written constitution that successfully manages a plural society until Medina becomes a strong and respected nation. Thus, this study has two objectives, namely to identify the principles of responsibility practiced in the Medina Charter and to examine the management of cross-cultural communities in the Medina Charter. This study uses a qualitative method through in-depth interviews to expert respondents and a (systematic) literature review. Content analysis was used to analyze the data obtained.

2. Context or background of the project

The background of this project was based on the cross-cultural society management in Medina Charter.

3. The importance of this project

This study is important to identify the principles of responsibility contained in the Medina Charter. In fact, this study also examines the management of cross-cultural communities in the Medina Charter. This is because the success of Muhammad PBUH in managing a cross-cultural society needs to be given special attention because managing a cross-cultural society is not something that is easy and requires various strategies. This can be used as a guide and reference to the community and the country to achieve harmony on an ongoing basis.

4. Advantages of this project towards education and community.

This study is beneficial in enriching the knowledge of the management of a plural society according to the Islamic perspective. In addition, this study also benefits the community as a reference and guide to build good relations in cross-cultural communities. Cultural diversity is unique but if not managed properly will cause fights and chaos. This poses a great threat to the stability of a country.

5. Commercial value in terms of marketability or profitability of the project.

This study is important as a contribution of knowledge in terms of management of a plural society through strategies implemented by the Prophet PBUH in uniting cross-cultural communities. The principle of responsibility contained in the Medina Charter creates a society that is responsible to the family, tribe, society and country.

Acknowledgement

This study is the result of a research grant. Special thanks are due to the Ministry of Higher Education (MOHE) which has sponsored this research under the Fundamental Research Grant Scheme (FRGS) (Grant no.: R/FRGS/A0800/01037A/004/2020/00888) for the year 2020.

References

- Abdullah Ahmad Qodiry Al-Ahdal (2003). *Tanggungjawab dalam Islam*. Selangor: Pustaka Ilmi.
- Guillaume, A. (2004). *The Life of Muhammad*. Karachi: Oxford University Press.
- Khairul 'Azmi Mohamad & Nooraini (2009). Nilai yang mendasari Integriti dan amalan Masyarakat Hadhari. Dlm. Khairul 'Azmi Mohamad et al., (Eds.), *Ke arah Umat Hadhari*. Kuala Lumpur:Yayasan Ilmuan.
- Munir Muhammad Al-Ghadban (2003). *Kerjasama Politik dalam Menegakkan Kerajaan Islam* (Terj. Mohd. Hapiz Mahaiyadin: Al-Tahaluf Al-Siyasi Fi Al-Islam). Selangor: Pustaka Ilmi.
- O. P. Simorangkir (1987). *Kesadaran Pikiran dan Tanggungjawab*. Jakarta: Yagrat.
- S. Abul A'la Maududi (1995). *Tanggungjawab Umat Islam dihadapan Umat Dunia* (Terj. Ilzamudin Ma'mur). Jakarta: Gema Insani Press.
- Saari Sungib (2013). *Rahsia-Rahsia Besar disebalik Sirah Rasulullah SAW*. Selangor: Kemilau Publika.
- Wan Z. Kamaruddin Wan Ali & Ahmad Zuhdi (t.t.). *Konsep Kewajiban dan Tanggungjawab (al-Taklif) dalam Pemikiran Islam: Penerapan dan Aplikasinya dalam Kehidupan Masyarakat Muslim*. Kuala Lumpur: Jabatan Akidah dan Pemikiran Islam Akademi Pengajian Islam, Universiti Malaya.

THE DOLLS KIT FOR EFFECTIVE INTERVIEW MAPPING STRATEGY (A MODEL FRAMEWORK)

Yohan Kurniawan

Faculty of Language Studies and Human Development
University Malaysia Kelantan, Malaysia
yohan@umk.edu.my

Mohammed Farhan Bin Md Yusof¹, Noor Raihani Binti Zainol², Yang Jia Qi³

¹ Registrar Office, Universiti Malaysia Kelantan, Malaysia

² Faculty of Entrepreneurship and Business, Universiti Malaysia Kelantan, Malaysia

³ Wu han Yiyantong Culture Development Co., Ltd, Hubei, China

Highlights: Play therapy is one type of therapy used in Psychology. Nevertheless, the concept of play used in this therapy can be used to explore and identify client problems in the interview and counselling process. This developed project aims to build a model framework to identify and explore in-depth the Psychological problems faced by clients. The frame of this model develops using dolls and supporting equipment such as home, office, and so on. Psychologists will use this model during the interview and counselling process to help them explore the real root cause of the client's problems. Identifying the real cause of the client's problems will significantly help the psychologist to plan a treatment or therapy program for his client.

Key words: *Play therapy, the dolls, Psychology, Counseling, Interview*

Introduction

Play therapy is a form of therapy used primarily for children. That's because children may not be able to process their own emotions or articulate problems to parents or other adults (Pietrangelo, 2019). Play therapy is practiced by a variety of licensed mental health professionals, like psychologists and psychiatrists. Behavioural and occupational therapists, physical therapists, and social workers also practice it (Pietrangelo, 2019).. According to the professional organization Play Therapy International, up to 71 percent of children referred to play therapy may experience positive change (Pietrangelo, 2019). While they become more comfortable and their bond strengthens, the child may become more creative or more verbal in their play. People of all ages can benefit from play therapy. Play therapy may be helpful in a variety of circumstances, such as (Pietrangelo, 2019):

- Facing medical procedures, chronic illness, or palliative care
- Developmental delay or learning disabilities
- Problem behaviors in school
- Aggressive or angry behavior
- Family issues, like divorce, separation, or death of a close family member
- Alami disasters or traumatic events
- Domestic violence, abuse, or neglect
- Anxiety, depression, grief
- Eating and toileting disorders
- Attention deficit hyperactivity disorder(adhd)
- Autism spectrum disorder(asd)

The play therapy concept will help explore the client's problems, especially those that do not reveal.

The Concept of Dolls Kit

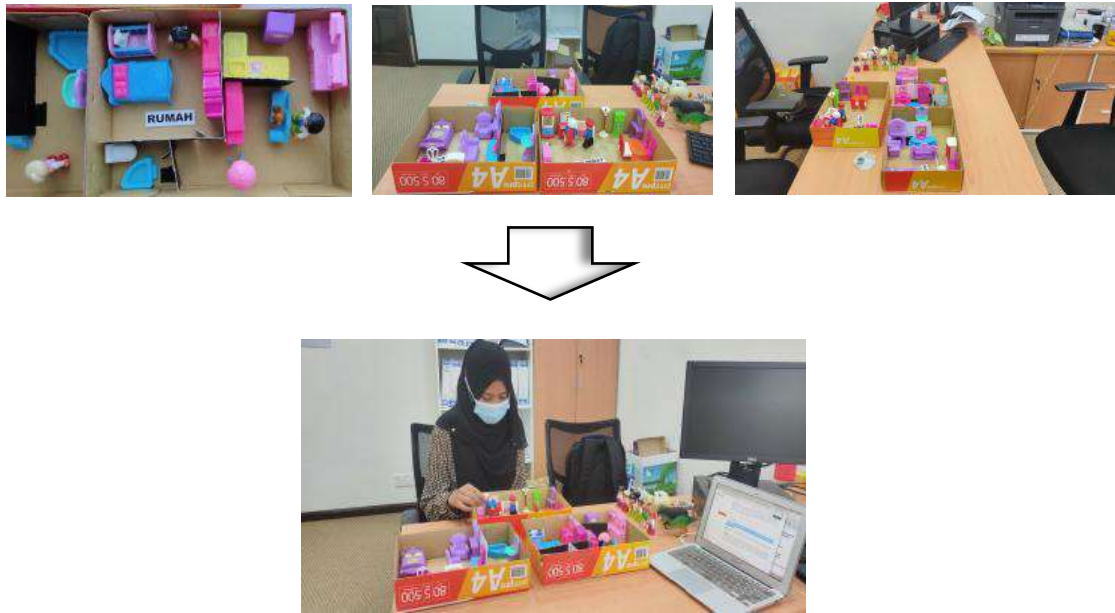

Picture 1. The Dolls Kit Equipment Model and Application

The product produced is a set of dolls equipment in the form of humans and support equipment in homes, offices, places of business, gardens, and so on. This equipment consists of several different sets such as home, office, neighborhood, relative, etc. This equipment can be used and dramatically helps Psychologists, Counselors, and Therapists to explore and uncover the problems faced by their clients.

This equipment is vital because it can help Psychologists, Counselors, and Therapists to identify and reveal problems that are not realized or can not be expressed directly by the client. During the beginning of the counseling process, the Psychologist/Counselor/Therapist will provide dolls with their equipment (first set) according to the problem. During the counseling process, doll sets and other equipment will be used together and complete the first set at the beginning of the counseling process. At the end of the counseling process, the Psychologist/Counselor/Therapist will map the problems based on the sets of dolls and their equipment to get a clear picture of the cause of the problems faced by the client.

The advantage of this equipment compared to the doll equipment used in current play therapy is the use of several sets of dolls kits at the same time to develop a map of the root cause of the client's real problems (client hidden problems).

These dolls kits and their equipment have commercial value because there is no dolls kit equipment with an interconnected concept and can be used to map the root causes of clients' "hidden" problems in the current market. Users of this product are Psychology specialists and practitioners, Therapists, Counselors, and students of Psychology, Counseling, and Social Work courses. The commercial value of this equipment is its small/medium shape so that it can store in a unique bag and is easy to carry.

Results of the Study of the Effectiveness Level of Dolls Kit Equipment

Based on the pilot project conducted on three respondents, the dolls and their equipment are suitable to explore the leading causes of the client's problems during the interview process. This pilot study also found that this equipment can map client problems based on information obtained from the set of dolls and their equipment used during the interview process.

References

Pietrangelo, A. (October 11, 2019). How Play Therapy Treats and Benefits Children and Some Adults. Access on: July 30, 2021 from <https://www.healthline.com/health/play-therapy>



CRI 2021

CARNIVAL OF RESEARCH AND INNOVATION
VIRTUAL INTERNATIONAL EDITION

PART 3

**LIST OF CONTRIBUTORS
STEAM**

WATERPROOF FIRESTARTER FOR OUTDOOR ACTIVITY

Saliza Anida Salleh

Sekolah Kebangsaan Jeli (1), 17600 Jeli, Kelantan
salizaanida@gmail.com

Yumna Fatima Khan¹, Nuralya Qaisara Mohd Hashim¹, Aydin Shamsul¹, Shamsul Muhamad²

¹Sekolah Kebangsaan Jeli (1), 17600 Jeli, Kelantan

²Universiti Malaysia Kelantan, 17600 Jeli, Malaysia

muatada@umk.edu.my, rosnahmostaffa@gmail.com, aydinshamsul@gmail.com, Shamsul.m@umk.edu.my

Highlights: The product namely ORANGE CAT is a waterproof firestarter for outdoor activity. It is made from natural material and able to burn around 10 minutes, which long enough starting fire on wood. It is individual wrap for handy use and pack of 10 units in a sealable plastic bag. This product prototype is ready for commercialize. The recommended price per bag is RM 10.00.

Key words: *Firestarter outdoor, waterproof, latex, Hevea brasiliensis.*

Introduction

Outdoor recreational activities such as exploration and camping away from basic facilities in the forest are enjoyable. They can build a healthy mind and body and get closer to the environment, especially children (Ouvry & Furtado 2019). Campfire Filling that is often done during this activity is cooking or safety preparation (Rawstrone 2020). However, they often face problems due to the difficulty of lighting fires quickly. Therefore, there are some firestarter are available in market to facilitate the process of ignition of fire (Williams 2020). However, firestarters are often accidentally malfunction due to wetness in raining or crossing rivers (Ward 2018).

Hence, we invented fire starter called ORANGE CAT that is waterproof and has a long enough burning time to burn fuel such as wood found in a forest. It is capable burning for 8.5 minutes to 10.4 minutes. The novelty of the product as it is packed in a resealable plastic and contain 10 individual wrap Firestarter. The package is almost flat to reduce cost of freight and the gross weight is 100 grams. In the package (gross weight 100 gram), there are ten firestarters that individually wrap using transparent plastic. Since this product is packed in according to commercial currier, it is ready for commercialize via online sale. The recommended price per bag is RM 10.00.

The advantages of our innovation process towards education is closely related to the subject activities of Science, and Design and Technology (RBT) which focuses on science process skills, product design and product packaging. For community, the product can helps increase income to rubber smallholders as it is easy to produce due to low technology.

References

- Ouvry, M., & Furtado, A. (2019). Exercising muscles and minds: Outdoor play and the early years curriculum. Jessica Kingsley Publishers.
- Rawstrone, A. (2020). We've explored...: campfires. *Nursery World Select*, 2020(11), 30-31.
- Ward, N. (2018). Igniting STEM learning through nature education. *Educating Young Children: Learning and Teaching in the Early Childhood Years*, 24(2), 12-13.
- Williams, C. N. L. (2020). The Power of Campfire Spaces for Diversity Education: A Case Study Analysis of the Diversity and Inclusion adVenture Experience Program (Doctoral dissertation, North Carolina State University).

DRONE@SCHOOL: NARROWING DIGITAL DIVIDE, INCREASING S.T.E.M CURIOSITY

Noor Janatun Naim Jemali

Universiti Malaysia Kelantan, Jeli, Malaysia
janatunnaim@umk.edu.my

Mohamad Radi Mohamed Rosly, Marinah Muhammad, Shaparas Daliman, Muhammad Firdaus Abdul Karim, Aqilah Abdul Rahim

Sekolah Kebangsaan Jeli I, Jeli Malaysia,
Universiti Malaysia Kelantan, Jeli, Malaysia
radirosly@gmail.com, marinah@umk.edu.my, shaparas@umk.edu.my, firdaus.ak@umk.edu.my,
aqilah.j17a0107@siswa.umk.edu.my

Highlights: A STEM-based education helps youngsters to develop abilities that will help them succeed in the future. However, digital divide caused them not been able to enjoy the benefits of it. This concern may affect students that resulted in lack of interest in Science, Technology, Engineering, and Mathematics (STEM) education. Using drone technology as a medium, we promote and develop student's inquisitiveness and curiosity towards science and ICT. This was done by a collaborative project between UMK and primary schools aim to promote the exchange ICT technical and knowledge among underprivileged students as well as to expose them to the recent technology in strengthening the STEM education. We believed, by addressing the issue of the digital divide and focusing on developing the required digital infrastructure, using right approach in digital education will facilitate both educators and students in adapting and increasing curiosity towards STEM education.

Key words: *STEM education, ICT, underprivileged, rural community, digital gap*

Introduction

Malaysia had shown the determination in efforts to bridge the digital gap between rural and urban residents to meet the needs of the national agenda which is to strengthen the ability of citizens to participate in the development of the digital economy. The implementation of ICT-based initiatives for the development of communities is a great opportunity. However, almost all rural communities in the world have a problem with technology and technical facilities and have not been able to obtain any benefit from the advantages of using ICT (Khan et al., 2012). The digital gap between urban and rural area formed different perception and awareness towards science curricular in school. This issue is very related to the primary education where the Science, Technology, Engineering, and Mathematics (STEM) curriculum implementation especially in the rural area.

The teaching of STEM has taken on new importance as economic competition has become truly global. STEM education has evolved that removes the traditional barriers of science and engineering, hence focuses on innovation and the applied process of designing solutions to complex contextual problems using current tools and technologies (Kennedy & Odell, 2014). This idea can be seen in the current document of the Malaysia Education Blueprint 2013-2025 (Preschool to Postsecondary Education) (Ministry of Education, 2013).

Education development in Malaysia has been reviewed and surprisingly the STEM discipline in Malaysia has given low attention compared to other disciplines (Jayarajah et. al., 2014). Engaging students in high-quality STEM education requires programs to include rigorous curriculum, instruction, and assessment, integrate technology and engineering into the science and mathematics curriculum and also promote scientific inquiry and the engineering design process. For this, competencies in all internal and external factors include ICT integration, organizing co curricular activities (Ahmad Zamri, 2017) and teaching delivery methods were counted to champion this agenda. Therefore, a pilot project in embracing ICT technology as an alternative / interactive tool for science education in the rural area is proposed to bridging the digital gap and improving the perception and awareness of STEM education among rural/underprivileged student in Kelantan.

Objective

The Drone@school Project aimed to promote knowledge exchange and ICT technical skills in narrowing the digital gap to the underprivileged community hence to expose the students in rural areas to recent technology in strengthening the Science, Technology, Engineering and Mathematics (STEM) education.

Project Description

The framework of the project is summarized as below:



Advantages to Education and Community / Novelty

The project aims to develop the ICT literate society and STEM knowledgeable school children in near future. It is also hoped that through this project, the gap of ICT knowledge among rural students in Malaysia will be narrowed down. A special drone module was developed by this team. Implementation of drone module to the school children focused for children to learn on physical and technical of drone and how it works. Students are taught the basic coding to fly the drone. While flying, they are enjoying the science behind this flying device. Children have also been taught on how to analyze and interpret the captured data from the drone.

To ensure the sustainability of operation of the systems after this project ends, few actions have been planned:

Monitoring the implementation of the pilot project

1. Monitoring will be done twice a year to the selected schools
2. Continuous knowledge-transfer-program (KTP) with teachers through ToT (train for trainers) the program will be carried out once a year

Module improvement

1. The developed module will be improved from time to time if needed
2. Expand the project to another rural area in Malaysia using the same/improved module4. IMPACT/USEFULNESS

Commercial Value

This is a #universityforsociety's project. This engagement is hoped could give a huge impact on both UMK and the surrounding community. By extricating this digital gap, the improvement of STEM education and awareness among underprivileged/rural student in Kelantan is expected to increase using this strategy.

Conclusion

Promotion and creation of a pilot project in occupying the ICT-based technology using drone technology application is the best tactic in building a knowledgeable society, especially in the rural area. This collaborative project achieved its goals which are to promote the exchange of ICT technical and knowledge among the underprivileged community as well as to expose the rural society with recent technology in strengthening STEM education. Interactive and effective use of recent technology easily engaged the student with tangible engineering activities and excises. Through this project, the gap of ICT knowledge among rural students for the focal group was narrowed down.

Acknowledgement

Involvement, assistance and support from participants and other individuals or groups either directly or indirectly were much appreciated. The project was funded by UMK-SIR research grant (R/SIR/A0800/00126A/02/2020/00864).

References

- Adhalina, N. (2011). The Different Language Style and Language Function Between Students and Teachers in Updating Their Status In Facebook Webpage (A Case Study of the Topic National Final Examination 2011)(Doctoral dissertation, University of Diponegoro).
- Alessandra, A. J., O'Connor, M. J., & Van Dyke, J. (1994). People Smarts: Bending the Golden Rule to Give Others what They Want. Pfeiffer.

SYSTEMATIC SYNTHETIC PHONICS: AN EVALUATION OF THE EFFECTIVENESS OF USING THE JOLLY PHONICS PROGRAMME TO TEACH READING

Norfarisha Elyana Abdullah

Sekolah Kebangsaan Penambang, Kota Bharu, Malaysia
farishaelyana@gmail.com

Najihah Mahmud¹, Nazirah Mahmud²

¹Universiti Malaysia Kelantan, Bachok, Malaysia

²Universiti Sultan Azlan Shah, Kuala Kangsar, Malaysia
najihah.m@umk.edu.my, nazeerah@usas.edu.my

Highlights: The Jolly Phonics Programme focuses on helping young learners develop their reading skills at the early stage in a fun and effective way by combining letter sounds with actions to assist them with the memorization process. Contrary to the conventional way of learning phonics, this program would be able to help minimise learner's confusion when it comes to pronouncing the word correctly.

Key words: reading, jolly phonics, systematic synthetic phonics, spelling, letter sounds, school

Introduction

Reading is one of the earliest language skills that is taught at school before writing, speaking and listening. It is common practice especially in primary schools in Malaysia to teach spelling right after the students were taught the alphabets, then only come writing and other skills. Teaching reading starts with teaching students how to spell words by combining letters or group of letters or syllables to form words, also known as phonics.

There are two types of phonics which are analytic and synthetic phonics. The conventional way to teach phonics in Malaysia is via analytical phonics, where students are taught to analyse the sound of the letters after the word has been identified. The issue with analytic phonics is that it starts at the word level as opposed to the sound level, making it confusing for a 6 years old to understand why the /h/ sound in the word 'house' is different with the word 'hour' (Shahanan, 2020a). On the other hand, synthetic phonics focus on teaching children "the letter-sound correspondences" and how to blend the sounds for each of the letters or letter combinations (Shahanan, 2020b). Hence, unlike analytic phonics, synthetic phonics starts at the sound level which makes it easier for young learners to make sense of (Umezina & Udogu, 2018).

Content

Jolly Phonics was first developed by primary school teachers from the UK, Sue Lloyd and Sara Wernham. It is a commercial programme published by Jolly Learning Ltd. The objective of The Jolly Phonics Programme are as follows:

- To reduce word-blindness among primary school children.
- To introduce a new technique to teach reading (systematic synthetic phonics).
- To encourage students to learn reading in a fun way by combining letter sounds and actions.

In the present study, six children aged 6-7 years old were chosen to participate in the first phase of The Jolly Phonics Programme. They were nominated by their parents to ensure that these children were committed to participate and complete the 12 weeks programme beginning with the introduction to the letter sounds to combination of several letter sounds with correct pronunciation.

The Jolly Phonics Programme was designed so it could be taught remotely and monitored closely by the parents themselves. Weekly videos were provided catering to every stage involved in teaching phonics synthetically. Children were required to watch the videos, and with the help of their parents, to follow the instructions given in the videos and the parents would video record their tasks to be submitted. The platform that was used for communication between the teacher and the students was via WhatsApp group chat. This was where the students submitted their videos and others could watch them and vice versa.

From the preliminary findings of this study, The Jolly Phonics Project appeared to be able to assist young learners to get started more easily as they all had zero knowledge on alphabets or phonics before the start of this programme as systematic synthetic phonics simplify the process of combining the letter sounds without having the children to keep making assumption on how the words should be pronounced. It is deemed timely for the Ministry of Education Malaysia to consider substituting the teaching of reading in English language using analytic phonics to synthetic phonics instead.

Acknowledgement

We would like to thank Sekolah Kebangsaan Penambang, Kota Bharu and Universiti Malaysia Kelantan (UMK) for tremendous support in this Jolly Phonics Programme.

References

- Shahanan, T. (2020a). Planning Effective Reading Instruction When You're up to Your Neck in 6-Year-Olds. *Educational Leadership*, 77(5), 62-67.
- Shahanan, T. (2020b, May 27). Which is best? Analytic or synthetic phonics? *Reading Rockets*. <https://www.readingrockets.org/blogs/shahanan-literacy/which-best-analytic-or-synthetic-phonics>

DESIGNING AND DEVELOPING YEAR ONE SCIENCE PEDAGOGICAL MODULE BASED ON STEAM LEARNING MODEL

See Too Kay Shi

University Malaysia Kelantan
kayshiseetoo@gmail.com

Assoc. Prof. Dr Ng Siew Foen

University Malaysia Kelantan
siewfoen@umk.edu.my

Highlights: Many countries have conducted various of research in the last few years to improve their students' achievement through STEM (science, technology, engineering, and mathematics) education. Malaysia also focuses on STEM and has stated STEM in the Malaysian Education Blueprint (2013-2015) to strengthen the science subjects in our country. Many studies show that integrating arts in STEM, which is known as STEAM education, is a critical education model for enhancing STEM. To apply STEAM education in Malaysia, Year one Science Pedagogical Module based on STEAM learning module is developed. The study employed Design and Development Research to develop the module.

Key words: *STEM, STEAM, Design and Developing Research (DDR), Pedagogy Module, fuzzy-Delphi Method and Education System*

Introduction

The 4th Industry revolution has bombarded us with unimaginable advances that require improved capacities in science, technology, engineering and mathematical (STEM) fields. STEM integrates and applies Mathematics, Science and Engineering to create technologies and solutions to solve real-world problems. However, the current Malaysian education system based on STEM is focusing on assessments and grades rather than recognizing activities that foster creativity, innovation, and critical thinking skills. Subsequently, students' interest in STEM subjects fell drastically behind the explosive growth of science and innovation. In the recent TIMSS and PISA results based on STEM educational attainment, Malaysia has been in the bottom two-thirds position of all the countries involved. The concept of STEAM—which brings the elements of STEM together with arts to guide students' critical thinking, inquiry, and dialogue are essential to be integrated into our science syllabus to stimulate creativity and innovation.

Module Development Design

Thus, this study aimed to 1. To develop Science Pedagogical Module based on STEAM learning education, 2. To validate the effectiveness of the Science Pedagogical Module and lastly 3. To evaluate the usability of the Science Pedagogical Module. The study employed design and development research (DDR) to develop a Science Pedagogical Module based on STEAM education. In the first phase, observation, semi-structured-interview and document analysis techniques were used to collect the data on a purposive sampling. The second phase a prototype was developed and experts in pedagogy, content and instructional design were consulted to evaluate and validate the prototype by using fuzzy Delphi method.(FDM). The final phase, formative evaluation was used to evaluate the usability of the Science Pedagogy Module base on STEAM education.

Important of Year One Science Pedagogical Module based on STEAM learning model

The findings of this study established a STEAM learning model based on project base learning that could be implemented in Malaysia science education. Advantages of STEAM module for student are learning with fun and experiences the learning process include communication, collaboration and 21st century skills as well. STEAM is an approach to positively impacting student performance. Brouillette, L& Graham, N.J (2016) Physical science learning in high poverty elementary schools in an urban district in grades 3 to 5 is influenced by STEAM lessons. STEAM activities such as project-based learning, designing, gaming, and so on can attract students toward science. Those who took part in STEAM lessons, according to Hong (2018), had a stronger "science preference" than students who did not.

Advantages of Year One Science Pedagogical Module based on STEAM learning model

The advantages for teachers are full set lesson plan are provided for teaching. This module is based on the year one science syllabus and variety of teaching activities students. Saving time of teaching also is one of the advantages of this module for teachers. STEAM solutions, according Segarra et al. (2018), are a useful complement to traditional teaching and training. More creative teaching activities and interests, such as gaming, gardening, dance, or crafts, might be added to the curriculum.

Commercial Value

STEAM learning education are important to Malaysia because it can bring new brand teaching direction to the whole education system especially for year one science subject. Hence, this module has its own commercial value to Ministry of Education, School and Student. This commercial value is an integrated among those who had involve direct or indirectly to the STEAM base learning and teaching approach.

References

- Graham, N. J., & Brouillette, L. (2016). Using Arts Integration to Make Science Learning Memorable in the Upper Elementary Grades: A Quasi-Experimental Study. *Journal for Learning through the Arts*, 12(1), n1. <https://eric.ed.gov/?id=EJ1125147>
- Segarra, V. A., Natalizio, B., Falkenberg, C. V., Pulford, S., & Holmes, R. M. (2018). STEAM: Using the arts to train well-rounded and creative scientists. *Journal of microbiology & biology education*, 19(1), 19-1. <https://doi.org/10.1128/jmbe.v19i1.1360>

WATER POLLUTION

Yumna Fatima Khan

Class 5, Al-Ghazali, Sekolah Kebangsaan Jeli 1 (SK Jeli 1), 17600 Jeli, Kelantan, Malaysia
muqtada@umk.edu.my

Saliza Anida Binti Salleh¹, Mohammad Muqtada Ali Khan², Hafzan Eva Manosr², Elvaene James²

¹Sekolah Kebangsaan Jeli 1 (SK Jeli 1), 17600 Jeli, Kelantan, Malaysia

²Department of Geoscience, Faculty of Earth Science, Universiti Malaysia Kelantan, Campus Jeli, Locked Beg No 100, 17600 Jeli, Kelantan, Malaysia

salizaanida@gmail.com, muqtada@umk.edu.my, hafzan.eva@umk.edu.my, elvaene@umk.edu.my

Highlights: The present extended abstract highlighting the problem of water pollution around us. Many health related issues are associated with water pollution such as poor blood circulation, skin problems, Cholera, stomach problem etc. In addition the water pollution also affect surface water and groundwater which leads to problem in drinking water, agricultural crops etc. The sub topics of extended abstract are importance of water, sources of pollution and how to stop water pollution are given below.

Key words: *Water pollution, sources, important*

Introduction

The sub topics of extended abstract are importance of water, sources of pollution and how to stop water pollution are given below.

Importance of Water

Water is one of the best gifts from Allah to all living beings on this planet. There is no life without water in this planet. A hungry man can live for many days, but a thirsty man can't as it is impossible to live without water. More than 70 % of the earth's area is covered with water in different forms. We use clean water for drinking, cooking purposes, cleaning, agricultural and industrial purposes. Water is an essential natural resource for us to live, but nowadays, the clean water level is decreasing day by day, and we should save it for the future.



Figure 1: Importance of water for different types

Sources of Water Pollution

Water pollution is one of the major hazard of today's world due to our carelessness. Many sources of water pollution around us such as Industrial waste dispose into the rivers, serious pathogens in our domestic drainage, release of heavy metals like Arsenic, Manganese, Chromium, Lead which present in the rocks as well as in soil that makes the water contaminated and lead to ground water poisoning, fertilizers, pesticides leachate from agriculture activities can also affect surface as well as the groundwater. Oil spills releases a huge amount of crude petroleum which affecting marine ecosystem. Water pollution can cause many serious diseases such as cholera, typhoid, dysentery and even poisoning. According to a WHO report around 842000 deaths occur every year due to the water borne diseases



Figure 2: Sources of Water pollution

Stop Water Pollution

There are many ways to reduce the water pollution –

- Water conservation is one of the best method to fight water pollution so that the clean water is made available to everyone.
- There should be a proper waste disposal system if we want to fight water pollution.
- Avoiding wastage of water and keeping our surrounding clean could help us keep the water clean and safe.
- Think twice before throwing anything down the sink and avoid throwing oils, chemicals, paints, etc.
- Polythene bags and plastic goods should not be disposed in rivers or seas; instead they should be recycled and reused.
- Use of pesticides and fertilizers should be highly reduced so that they do not contaminate surface and groundwater.
- The urban waste water should be properly treated before draining into rivers so that it does not affect the aquatic species.
- Draining of industrial residues and waste into the river should be completely banned by the government.

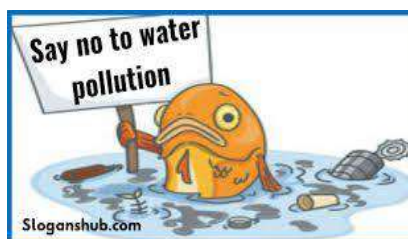

Figure3: Way of stop water pollution

Acknowledgement

We are grateful for Sekolah Kebangsaan Jeli 1 (SK JELI 1) to provide basic facilities for this carnival. We also acknowledge to my Mom, Kakak Ain, Kakak Hanna, and Kakak Najwa for their continuous advices.

References

- 10 Lines Essay (n.d.). Home (10 Lines Essays). YouTube. Retrived August 1, 2021, from https://www.youtube.com/watch?v=RA3DCLbPUKq&ab_channel=10LinesEssayPfeiffer.
- White Planet Technologies Pvt Ltd. (n.d.). 10 lines on water pollution. Retrived August 1, 2021, from, <https://www.teachingbanyan.com/10-lines/10-lines-on-water-pollution/>
- Pro English Essay (n.d.). Best 5 Sentences, 10 Lines & Short Essay on Importance of Water. Retrived 31 July, 2021, from <https://proenglishessay.com/short-essay-on-importance-of-water/>

**YOGURTINI – A BENEFICIAL YOGURT WITH NATURAL STINGLESS BEE (*MELIPONINI*)
HONEY’S JELLY GUMMY**

Khairinawati Binti Shuib

SMK Alor Pasir, Tanah Merah, Kelantan, Malaysia
khairinawati06@gmail.com

Nor Syawalnie Binti Ghazali, Nor Alisya Maisarah Binti Norhisham, Muhd Al-Amin Shah Bin Mohd Asmadi, Aniff Bin Affenddy, Muhamad Sabri Bin Saidi, Aniq Fahmi Bin Mohammad Zainal, Nur Alia Maisarah Binti Nawawi, Muhd Danial Irfan Bin Mohammad Zu, Nur Ainatul Amani Binti Isa, Nur Athirah Binti Mohd Sayuti, Azhaney Binti Abdullah, Azfi Zaidi Bin Mohammad Sofi Aziz, Nor Hakim Bin Abdullah

SMK Alor Pasir, Tanah Merah, Kelantan, Malaysia
Universiti Malaysia Kelantan, Malaysia

azhaneyabdul@gmail.com, azfi.ms@umk.edu.my, norhakimin@umk.edu.my

Highlights: Yogurt is a nutritional food that contain benefitable nutrition such as protein, zinc and calcium. Nevertheless, most ready-to-eat yogurt product in the market contain artificial sugar as an added sweeten element and it can bring harmful to our health and body. This is because sugar contain a refined fructose and possess high glycemic index (GI) level. Therefore, the product proposed here is a yogurt with natural stingless bee (*meliponini*) honey’s jelly gummy as an added sweeten element. The stingless bee (*meliponini*) honey was selected as a sweeten added element because it has lower glycemic index (GI) level and more benefitable compared to sugar.

Key words: yogurt, honey, jelly gummy, stingless bee, *meliponini*, natural product

Introduction

Yogurt is a nutritional food and is good for our body to consume. It is because yogurt is considered to be a fermented dairy food carrying viable bacteria with health-promoting effects (Morelli, 2014). Yogurt is well known a food rich in important nutrients, high in protein, improve digestive system, helping weight management and many more great benefits. Moreover, by adding natural stingless bee (*meliponini*) honey’s jelly gummy into the yogurt, it will greatly improve the taste of the yogurt. The stingless bee (*meliponini*) honey has higher antimicrobial activity and less sugar content compared to most honey bees (Amin et al. (2018) & Rao et al. (2016)) and it is far greater compared to sugar in term of its benefitable. Therefore, we choose stingless bee (*meliponini*) honey as added flavour to the yogurt.

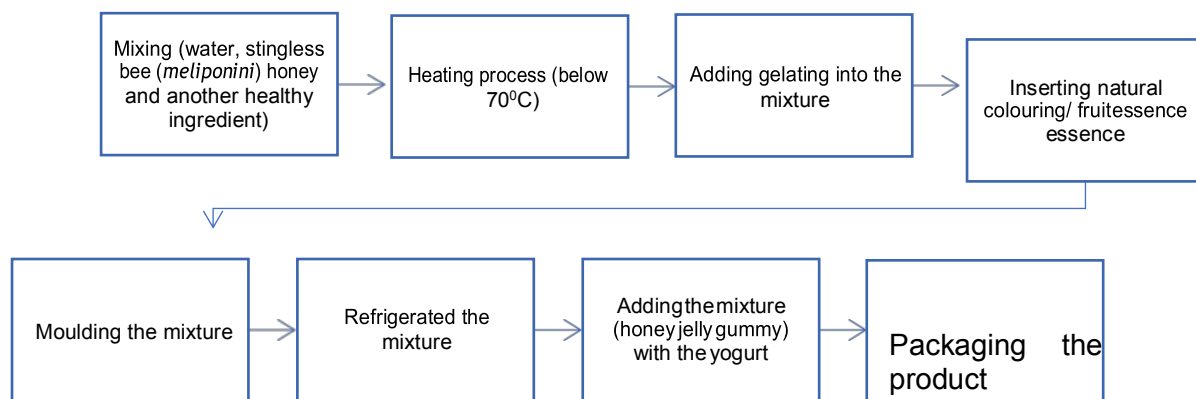

Figure 1: Development process for Yogurtini

The supply of stingless bee (meliponini) honey is taken from our school project at SMK Alor Pasir, Tanah Merah, Kelantan. This project also involves the local community of stingless bee honey supplier because the raw material of the product also is bought from them. This project is supervised by two facilitators from Faculty of Bioengineering and Technology, Universiti Malaysia Kelantan. This product has a potential commercial value in Malaysia market because of the benefitable elements in Yogurtini. Yogurtini also is unique because there is no yogurt product in Malaysia market that use natural stingless bee (meliponini) honey's jelly gummy as an added flavour in the yogurt.

Acknowledgement

We are grateful for the involvement of facilitators from Faculty of Bioengineering and Technology, Universiti Malaysia Kelantan, Dr Azfi Zaidi bin Mohammad Sofi and Dr Nor Hakim Bin Abdullah. We also would like to thanks all the students involve in this project which all are selected from B40 families.

References

- Morelli, L. (2014). Yogurt, living cultures, and gut health, *The American Journal of Clinical Nutrition*, Volume 99, Issue 5, Pages 1248S– 1250S.
- Amin, Z., Aina, F., Sabri, S., Mohammad, S.M., Ismail, M., Chan, K.W., Ismail, N., Norhaizan, M.E. and Zawawi, N. (2018). Therapeutic properties of stingless bee honey in comparison with European bee honey, *Adv. Pharm. Sci.*, 1–12.
- Rao, P.V., Krishnan, K.T., Salleh, N. and Gan, S.H. (2016). Biological and therapeutic effects of honey produced by honey bees and stingless bees: A comparative review, *Rev. Bras. Farm.*, 26, 657–664.

PRODUCTION OF BIOGROWTH POT (BIO-G POT) FROM LOCAL AGRICULTURE WASTE FOR CROP SEEDLING APPLICATION

Azhaney Binti Abdullah

SMK Alor Pasir, Tanah Merah, Kelantan, Malaysia
azhaneyabdul@gmail.com

**Aniq Fahmi Bin Mohammad Zainal, Nur Alia Maisarah Binti Nawawi,
Muhd Danial Irfan Bin Mohammad Zu, Nur Ainatul Amani Binti Isa, Nur Athirah Binti Mohd Sayuti,
Nor Syawalnie Bt Mohd Ghazali, Nor Alisya Maisarah Binti Norhisham,
Muhd Al-Amin Shah Bin Mohd Asmadi, Aniff Bin Affenddy, Muhamad Sabri Bin Saidi,
Khairinawati Binti Shuib, Nor Hakim Bin Abdullah, Azfi Zaidi Bin Mohammad Sofi@Aziz**

SMK Alor Pasir, Tanah Merah, Kelantan, Malaysia
khairinawati06@gmail.com, norhakimin@umk.edu.my, azfi.ms@umk.edu.my

Highlights: Modern agriculture, in particular, makes extensive use of plastics, such as direct covers, greenhouse covering films, soil mulching, and solarization films which could exacerbate the environmental pollution problem. To overcome this problem, in this research, Biogrowth Pot (Bio-G Pot) was prepared from a mixture of agricultural waste, namely banana stem fiber and eggshell powder. The mixture then was mixed with starch and followed by moulding the mixture into a pot for the crop seedling, i.e chillies. The Bio-G Pot could serve as biodegradable polybag and growth media for crop seedling.

Key words: *agriculture waste, biogrowth pot, banana stem, eggshell powder, crop seedling*

Introduction

The use of plastics based on non-renewable petroleum-sources in agriculture represents a growing threat to the environment. Polybag made from polyethylene is non-biodegradable and contains resin that can contaminate the soil and harm the environment if the waste is not handled properly (Akinro et al. 2012; Kasirajan and Ngouajio, 2012). In addition, tearing the polybag during transplanting has caused the medium breakdown and root damage that potentially stagnate the seedling after transplanting.

One way to prevent the stress that might occur while transplanting due to the usage of polybags is to use a biodegradable pot. Biodegradable containers have the benefit of being readily decomposed, allowing nutrients to be released from the pot, and contributing organic matter to the soil (Jirapornva-ree et al. 2017).

In this research, Biogrowth Pot (Bio-G Pot) was prepared from a mixture of agricultural waste namely banana stem fiber and eggshell powder. The mixture then was mixed with starch and followed by moulding the mixture into pot for the crop seedling, i.e chillies. It is expected that the prepared BioG Pot could be beneficial for biodegradable polybag for the crop seedling as well as provide an excellent growth media for plant.

Content

The banana stem was chopped and cut into a fiber while the eggshell was ground into powder. Then, banana stem fiber and eggshell powder were mixed with starch as binder and followed by putting the mixture in a mould. Then, the sample was dried under the sun and ready for usage. The overall process for Bio-G Pot preparation is illustrated in figure 1.



Figure 1. The overview of BioG Pot preparation.

This innovation implementing the waste to wealth concept where we use the agriculture waste to create a new product for agriculture namely Bio-G Pot. Biodegradable containers are a sustainable alternative to petroleum based pots that can readily adapt to horticulture and floriculture production, eliminating massive amounts of plastic waste while also giving excellent marketing potential.

This project involves B40 students under SMK Alor Pasir. The main purpose of this project is to encourage student involvement in STEM. Through this project, students are given exposure related to STEM activities for product production.

Advantages of Innovation

Among the advantages of this innovation are:

1. Bio-G Pot could serve as biodegradable polybag and growth media for crop seedling
2. Implementation Waste to Wealth concept to create a new useful product from agriculture waste
3. Reduce the environmental impact

This product involves community engagement where the banana stem was obtained from local farmer while the eggshell waste was obtained from the local bahulu seller. This project is also in collaboration with National STEM Association, Malaysia.

Acknowledgement

We are grateful for the given funding from National STEM Association and SMK Alor Pasir, Tanah Merah, Kelantan for this project.

References

- Akinro, AO, Ikumawoyi, OB, Yahaya, O, Ologunaba, MM (2012) Environmental impacts of polyethylene generation polyethylene and disposal in Akure City, Nigeria. *Globe J Sci Front Res Agric Biol* 12(3)
- Jirapornvaree, I, Suppadit, T, Popan, A (2017) Use of pineapple waste for production of decompostable pots. *Int J Recycl Org Waste Agric* 6(4):345-350
- Kasirajan, S, Ngouajio, M (2012) Polyethylene and biodegradable mulches for agricultural applications: A review. *Agro Sustain Dev.* 32(2):501-529

TRIMBOT: REMOTE CONTROL LAWN MOWER

Wan Nur Batrisyia Irwan

SMK Proton City, Proton City, 35900 Tanjung Malim, Perak, Malaysia
wnbatrisyiairwan@gmail.com

Muhammad Muaz Lasim¹, Zulaiqah Badrul Isham¹, Zalina Ahmad¹, Norulshaidah Mohamad¹, Raja Noor Farah Azura Raja Ma'amor Shah²

¹SMK Proton City, Proton City, 35900 Tanjung Malim, Perak, Malaysia

²Department of Mathematics, Faculty of Science and Mathematics, Universiti Pendidikan Sultan Idris, 35900 Tanjung Malim, Perak, Malaysia

rmuhammadmuaz947@gmail.com, Zulaiqahbadrul72@gmail.com, zalinakejo@gmail.com, arrdni2110@gmail.com, raja_farah@fsmt.upsi.edu.my

Highlights: Nowadays, many house owners spend hours cutting lawns in their garden or backyards and wasting money hiring people to mow the lawn. They need to pay a large sum of money to have a small area of lawns mowed. Thus, this project focuses on the design and implementation of a low cost, user-friendly, portable, durable, easy to operate and safety lawn mower. This TrimBot is remotely controlled via a smartphone using Bluetooth. It can be used at any time, repeatedly and easy to bring anywhere. This TrimBot can also keep away users from dangerous threat such as venomous animals and sharp objects.

Key words: lawn mower, trim, Bluetooth, remote control, user-friendly, Arduino

Introduction

Malviya et al. (2015) has reported that 70% of Malaysian home citizens are utilizing fuel powered lawn mowers for their daily grass cutting routine. Thus, high maintenance is needed in order to maintain a lawn mower. They need to change the fuel or oil regularly to make sure the lawn mower works efficiently cutting the grass. This scenario will incur extra cost since the price of fuel has increased lately (Shaari et al., 2013). In order to overcome these issues, an eco-friendly lawn mower needs to be designed to support the green technology initiatives (Tanimola et al., 2014). Technology had continued to advance and better techniques of lawn mower has been invented and constantly improved upon. Many different designs have been made, each suited to a particular purpose. Due to advances in technology and innovation, we can solve complex problems using remotely controlled robots (Bodke et al. ,2018). The motivation of this project was to eliminate the shortcomings and potential risks associated with the existing lawn mowers. This led us to the pilot test of a mobile application-controlled lawn mower. Furthermore, it is evident that there is a high demand for automation systems (Kumar et al., 2016).

TrimBot Design

The purpose of this project was to design an economic lawn mower controlled via a smartphone. This innovation allows house owners to mow their lawn from the comfort of their houses using their smartphones. The lawn mower is controlled via mobile phone in an intended direction using Bluetooth technology. Thus, this project focuses on a low cost, user-friendly, portable, durable, easy to operate and safety lawn mower. This lawn mower prototype called TrimBot consist of Cable (single core wire), jumper wire, breadboard, HC-05 Bluetooth, motor driver (MDD10A), 755 DC motor 12 V, bracket, battery, wood stick, plastic box, trimmer line, Maker Uno (microcontroller) and 1/8 RC truck as shown in Figure 1.



Figure 1: Components of TrimBot

Figure 2 shows the design of TrimBot.

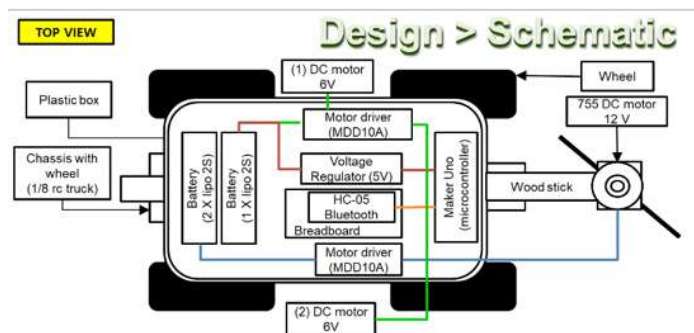

Figure 2: Schematic Design of TrimBot

Commercial Value

Marketability to all owners of landed houses, schools, universities, playgrounds, meadows, gardens and so on.

Impact to society

- Can produce an innovative product that meets the industrial revolution.
- Reduce the country's problems such as man power (importing foreign workers), economy (increased outflow of national currency), health (infectious diseases), (law) crime and many more.
- Preserving the sustainability of nature and go green technology.

Conclusion

The usage of this TrimBot makes the grass cutting process faster by reducing the cutting time. Besides that, it is lighter, environmentally friendly and cost effective which is helpful in maintaining and trimming the grass in gardens, home, or yards.

References

- Malviya, P., Patil, N., Prajapat, R., Mandloi, V., Patil, P.K., Bhise, P. (2015). Fabrication of Solar Grass Cutter. *International Journal of Scientific Research in Science, Engineering and Technology (IJSRSET)*, 2(2), 892-898.
- Shaari, M.S., Pei, T.L., Rahim, H.A (2013). Effects of oil price shocks on the economic sectors in Malaysia. *International Journal of Energy Economics and Policy*. 3(4), 360-366.
- Tanimola, O. A., Diabana, P.D. and Bankole, Y.O. (2014). Design and Development of a Solar Powered Lawn Mower. *International Journal of Scientific & Engineering Research*, 5 (6), 215-220.
- Bodke, D., Gosavi, V., Choudhari, R. and Nivedita, P. (2018). Smart Home Automation System using Mobile Application., *International Research Journal of Engineering and Technology (IRJET)*, 5(10), 1093-1098.
- Kumar, R., Ushapreethi, P., Kubade, P.R. and Kulkarni, H.B. (2016). Android Phone controlled Bluetooth Robot. *International Research Journal of Engineering and Technology (IRJET)*, 3(4),104-113.

BOM WARISAN

Al-Aqif Hafez bin Al Kamalrolzaman

MRSM Bentong, Pahang, Malaysia
aqif180222@bentong.mrsm.edu.my

Nur Iman Amani binti Khairil-Iszuddin, Fathin A'liya binti Mohamad Jamaludin

MRSM Bentong, Pahang, Malaysia
iman180060@bentong.mrsm.edu.my, fathin180088@bentong.mrsm.edu.my

Highlights: *Bom Warisan* is a portable educational game card that is innovated to help struggling students to understand and memorise the terms in History textbook as History subject is known as one of the most disliked subjects in school. This game card is made to help them understand the subject better and achieve better scores in exams.

Key words: *game card, history, educational*

Introduction

Have you ever played game card before? At least this one is going to help you to achieve higher marks in your History. Seeing our friends struggle in understanding and memorizing terms in the textbook makes us more determined to innovate a product for them to solve this problem. Our main goal is to prove that learning should not be hard and exhausting. We want to make the opposite true! Thus, *Bom Warisan*, the game card is created.

Bom Warisan

We innovated a game card based on the KSSM History Textbook to help students memorize difficult terms in the book. The game uses the basics of pairing terms and its meanings together. Students take turns collecting as many pairs as possible while still avoiding 'the bomb'. In addition, it also incorporates modern technological elements by using QR code attached with questions, printed on the card.

We find that a lot of students face difficulties with History subject. Specifically, difficulties in understanding and memorizing History subject's terms. After doing an observation, we find that the approach of combining education and entertainment (games) is more effective to increase students' interest in learning.

The importance of our innovation is to help teachers to create a more cheerful and fun environment of learning. Consequently, help students understand more about historical events and to gain more interest in learning History.

Advantages of our product include providing a more interactive learning environment for teachers and students. We can also become a stepping stone to building a better learning environment for History subject that breaks the norm of the boring learning style in schools and exchanging it with a more engaging educational games approach. Furthermore, the concept of pairing cards in *Bom Warisan* is versatile and it can be used for different subject as well.

The product can be marketed to schools and educational institutions which is a large target customer aged 13-17 years old. This will contribute to a high marketability. In addition, the cost of making the product is inexpensive. Thus, profitability of the product quite high if priced at the right rate. Other than that, the versatility and simplicity of the card game concept as mentioned before, will also increase the business opportunities.

Acknowledgement

We would like to express our special appreciation and gratitude to our advisors, Puan Noraniza Osman and Encik Mohd Yazid Mohd Shariff, who gave us this golden opportunity to share our ideas and innovation, *Bom Warisan*. Next, we would like to thank our friends who inspired the product and help us in pilot testing and commenting it so that we can make improvements.

References

Ridzuan bin Hasan, Sharifah Afidah binti Syed Hamid, Muslimin bin Fadzil, Subramaniam a/I Raman. (2019). KSSM Sejarah Tingkatan 4. Dewan Bahasa dan Pustaka.

EnviroMPlasc
(FOOD PACKAGING FROM COCOPEAT, LEMONGRASS AND COGON GRASS)

Najwa Ariena Mohamad Azizie

SMK Kubang Bemban, Pasir Mas, Kelantan, Malaysi
najwaazizie@gmail.com

**Siti Nur Eleya Maisarah Abdul Rahim, Thasni Balqis Mohammad Yusof, Nur Aqish Putri Mohd Zailani,
Nur Aini Rosdi, Nor Zaihan Shamsudin**

SMK Kubang Bemban, Pasir Mas, Kelantan, Malaysi
sitieleya@gmail.com, balqisthasni@gmail.com, aqishputri2005@gmail.com, ainirosdi05@gmail.com,
norzaihans@gmail.com

Highlights: Plastic waste is now a major source of waste disposal not only in our region, but across the world. This is a problem that concerns human beings and all marine species. Consequently, we decided to exclude plastic waste from the production of food packaging from naturally accessible components. The cocopeat, lemongrass, and cogon grass are the main focus of this packaging method analysis. First, the ingredients were boiled and mixed with soda ash until they became pulp. The pulp would then be poured into a container to be mixed. The mixture is moulded by the *Papier-mâché* technique after the mixing phase. The drying process can take 6 to 12 hours to complete the formed mixture. Furthermore, the drying process is driven by solar energy, so no energy is wasted. For the testing stages, some experiments are used to investigate the suitability of the food packaging, such as tensile strength tests and biodegradable tests. It has shown that EnviroMPlasc is better compared to regular food packaging.

Keyword: food packaging, natural resources, cocopeat, lemongrass, cogon grass, pulp

Introduction

Our project is focused on how to repackage plastic-covered food products such as sandwiches that are wrapped in plastic, fruit that is packed in plastic packaging, and polystyrene cups that are used for coffee or water. Our main aim is to produce non-based-plastic food packaging that could help to save our environment.

The key goal of this initiative is to reduce the amount of plastic used in food packaging. Consequently, we decided to exclude plastic waste in the production of the food packaging from naturally accessible components such as cocopeat, lemongrass and cogon grass.

We also use edible bioplastic in our sandwich packaging. This bioplastic is transparent, so we can see through into the sandwich box. Other than that, we make this bioplastic using 100% non-based-plastic material. Therefore, we can reduce the use of plastic in the food packaging industry.

Content:

1. Description of EnviroMPlasc

Problem Statement

Food packaging has been criticised as one of the most polluting industries in the world. Not only the production, but the consumption of plastics also produces waste. Exposure to harmful substances emitted by plastics has been linked to tumours, birth defects, and weakened immunity. Most plastic waste comes from food packaging manufacturing. Researchers are investigating a food packaging material entirely made of natural fibres.

Hypothesis

To create EnviroMPlasc Food Packaging from natural materials such as cocopeat, cogon grass, and lemongrass that is suitable for all types of food and does not harm the environment.

Objectives

- i. The main objective of this product was to create food packaging with natural ingredients such as cocopeat, lemongrass, and cogon grass.
- ii. To produce edible bioplastic for wrap of our sandwich box.
- iii. To develop low-cost food packaging with high quality.
- iv. To produce biodegradable food packaging that works as compost fertilizer.
- v. To decrease the usage of metal, plant matter (paper and wood), glass and plastic for the making of food packaging.

2. Process

Materials and Apparatus Used in Making of EnviroMPlasc

We are using natural resources such as cocopeat, lemongrass and cogon grass for the making of EnviroMPlasc. We are also using distilled water and blender to make sure the process of making going smoothly.

Figure 1: Procedure and The Making of EnviroMPlasc

Cutting	The ingredients are cut into small pieces to make them easier for the next step.
Boiling	The cocopeat, lemongrass, and cogon grass were boiled for 2 hours with soda ash.
Blending	All the main ingredients were blended until they formed a pulp fibre.
Filtration	All the pulp fibre is filtrated using a strainer.
Mixing	All the ingredients are mixed in the container.
Moulding	The mixture is shaped onto the mould.
Drying	The product is dried up under the sun for 6-12 hours. (depends on the size and thickness)
Product Test	The product is ready to be tested and used.

3. Important of EnviroMplasc for Education

Our EnviroMPlasc products help students understand how their decisions and actions affect the environment, build the knowledge and skills necessary to address complex environmental issues, and identify ways we can take action to keep our environment healthy and sustainable for the future.

It's important to help students take what they're learning and put it into practice. Creativity is a vital value to human society, and it's an important assessment tool. Teachers should create practical ways for students to apply what they are learning. As students develop these skills, they have the opportunity to tap into their inherent strengths in developing critical thinking and problem-solving skills.

4. Advantages

The major benefit of EnviroMPlasc is that all of the components are renewable. It is manufactured using non-polluting ways, as solar energy is widely utilised nowadays. Furthermore, the manufacture of this product is low-cost, low-investment, and biodegradable, since it decomposes quickly and may be recycled as bio pot. More significantly, EnviroMplasc is acid-free, pH neutral, and ecologically friendly.

5. Commercial Value

Table 1: Production cost

No	Item	Cost (RM)
1	Cocopeat (Waste) (500g)	Free
2	Lemongrass (Waste) (300g)	Free
3	Cogon Grass (Waste) (300g)	Free
4	Glycerol (12 g)	0.06
5	Gelatin powder (48 g)	0.05
6	Electric (per month) (2 hours usage daily for three days)	4.80
	TOTAL COST FOR 8 CONTAINERS	4.91
	TOTAL COST FOR 1 CONTAINER	0.61

Acknowledgement:

The authors acknowledge the support of the EnviroMplasc Project. The authors would like to thank our Principal, Tn. Hj. Sukri Hassan, our mentor, Nor Zaihan Shamsudin, students and staff of SMK Kubang Bemban. Also, the authors thanked the school R&D and Innovation Club for providing the financial support.

References:

- Marsh, K., & Bugusu, B. (2007). Food packaging—roles, materials, and environmental issues. *Journal of food science*, 72(3), R39-R55.
- Chisenga, S. M., Tolesa, G. N., & Workneh, T. S. (2020). Biodegradable Food Packaging Materials and Prospects of the Fourth Industrial Revolution for Tomato Fruit and Product Handling. *International Journal of Food Science*, 2020.
- Motelica, L., Ficaï, D., Ficaï, A., Oprea, O. C., Kaya, D. A., & Andronescu, E. (2020). Biodegradable antimicrobial food packaging: Trends and perspectives. *Foods*, 9(10), 1438.
- Matmatch, G. (2021) Materials Used in Food Packaging. <https://matmatch.com/learn/material/materials-used-in-food-packaging>
- Rooland, (2019). What is Eco-Friendly Packaging. <https://www.rooland.com/what-is-eco-friendlypackaging/>
- EcoBahn. (2019). Sustainable Packaging Insights: Eco-Revenue. <https://theecobahn.com/packaging/sustainable-packaging-insights-eco-revenue/>
- Derrick, L. (2017). Liquid Handwash: Green Packaging. <https://www.packagingoftheworld.com/2017/10/liquid-handwash-green-packaging.html?m=1>

POTATO AS A POTENTIAL ORGANIC WATER CARRIER UTILIZED IN REDUCING SALINITY IN SALT SOLUTION

Atifah binti Abdul Azmil

Kolej GENIUS Insan, Nilai, Malaysia
atifahazmil@raudah.usim.edu.my

Nurul Izzan binti Abdul Razak, Muhammad Safwan Bin Khairudin, Muhammad Azan bin Tamar Jaya

Kolej GENIUS Insan, Nilai, Malaysia
nurul.izzan@raudah.usim.edu.my, muhdsafwankh@raudah.usim.edu.my, azan@usim.edu.my

Highlights: Current work focuses on investigating the rumours or myths saying that adding potatoes would be able to fix an oversalted dishes, particularly soups. Based on our survey in the internet, there are various sources and blogs reporting yes and no. And the test they carried did not carry proper scientific and empirical method. In this study, we would like to carry out the experiment in testing and finding out if potato would be able to cause any effect on salinity through salt solution. With proper volume and mass measurement, salinity refractometer to record the salinity properly, and proper experimentation, we believe the rumours can be answered accordingly. The results showed that boiled potatoes immersing into salt solution (8%) indeed were able to reduce salinity up to 20 %. The potatoes did not act as an adsorbent, but functioned as water carrier allowing diffusion of salt ions from the concentrated solution into the less concentrated water region carried by the potatoes. In this abstract, we detailed out the methodology and further interpretation of the results.

Key words: Salinity, Water Carrier, *Solanum Tuberosum*, Potato

Introduction

The popularity of cooking and the active spreading of information has brought around many tips, tricks on ways you could improve a dish. Namely, the trick where potatoes or *Solanum Tuberosum* are used to reduce the salinity of an oversalted dish. There were many attempts to debunk this method however this study is the first discussion on the topic done in an empirical and scientific manner. This study aims to not only identify the correlation of potatoes and the salt content of a dish but also uncover the scientific explanation behind it.

Description

The invention was found through our study which was done by executing a series of experiments where the potatoes are left to soak in 8% salinity salt solutions with calculated volume salt solution and mass of the potato used as the raw materials. The salt solution (80g dm^{-3} Natrium Chloride Solution) was prepared by mixing NaCl (table salt) into an amount of water (8 g NaCl/100 ml water). The raw materials, which were potatoes, were firstly cut into cubes with a mass of approximately 50 g. Then, they were categorized into three batches. The first batch was the cut raw potatoes that were directly immersed into the salt solution and changes were recorded. The second batch was the cut raw potatoes were dried until the mass constant, and then immersed into the salt solution. And the third batch was the cut potatoes were boiled for 12 minutes (till it is soft), tossed, and then immersed into the salt solution. Each salt solution was 150 ml. The experiment was repeated 3 times.

Before readings were taken, the potato were removed from the solution. The volume of the solution was ensured to remain at 150 ml. If the reading was less than 150 ml, an amount of fresh water was added. If the reading was more than 150 ml, the solution was gently heated to vaporize some amounts with some adjustment with freshwater addition till its volume returned to 150 ml. This was done to minimize uncertainty due to accidental external water addition or removal (natural water carried by the potatoes and residue water from the boiling). Diagram 1 summarizes our experiment.

Our experiment indicated that the first batch (raw potato) showed almost 15 % of reduction in salinity. The second batch (dried raw potato) showed no reduction in salinity. The third batch (cooked potato) shows up to 20 % of reduction in salinity.

Discussion

Table 1 summarizes the results of our experiment. To rationalize our findings, we have carried out further investigations to uncover the scientific explanation to the reduction of salinity. Our initial hypothesis was that the reduction was caused by the potato possibly being an effective adsorbent for dissolved salts. To confirm our hypothesis, we have repeated our experiment however by replacing the previously used boiled potato with a completely dried potato and putting it into a salt solution. However, the results from this experiment did not demonstrate any changes in the salinity of salt solution. Therefore, we can safely conclude that the potato has no adsorbing properties in capturing dissolved salts since other adsorbents such as activated carbon and zeolites are normally prepared as dried materials (Arafat et al., 1999; Goursoot et al., 1997).

Table 1: Differently treated potato vs salinity reduction

Sample	Salinity (permille)		Salinity Reduction (average)
	before	After (average)	
Control solution (no potato)	85	84.33	0.78%
Boiled potatoes	85	68.67	19.22%
Raw potatoes	85	73.33	13.73%
Dried Potatoes	85	84.67	0.39%

On the other hand, the results of our experiment showed that the potato was able to reduce the salinity of a salt solution because the potato acted as a water carrier. We believed that the reduction of the salinity was due to the movement of salt ions from the concentrated solution to the less concentrated solution. It is inline with the diffusion concept we learned in Chemistry class. In this case, the potato actually functions as a fresh water carrier that provides a medium to receive a portion of the salt ions from the concentrated salt solution. As some of the salt diffuses into the less concentrated region in the potato, the whole salinity of the solution is equalized, thus the salinity of the whole solution was reduced. This result is even more obvious when we used cooked potatoes which have higher content of water in their structure. The salinity reduction reached up to almost 20 % reduction.

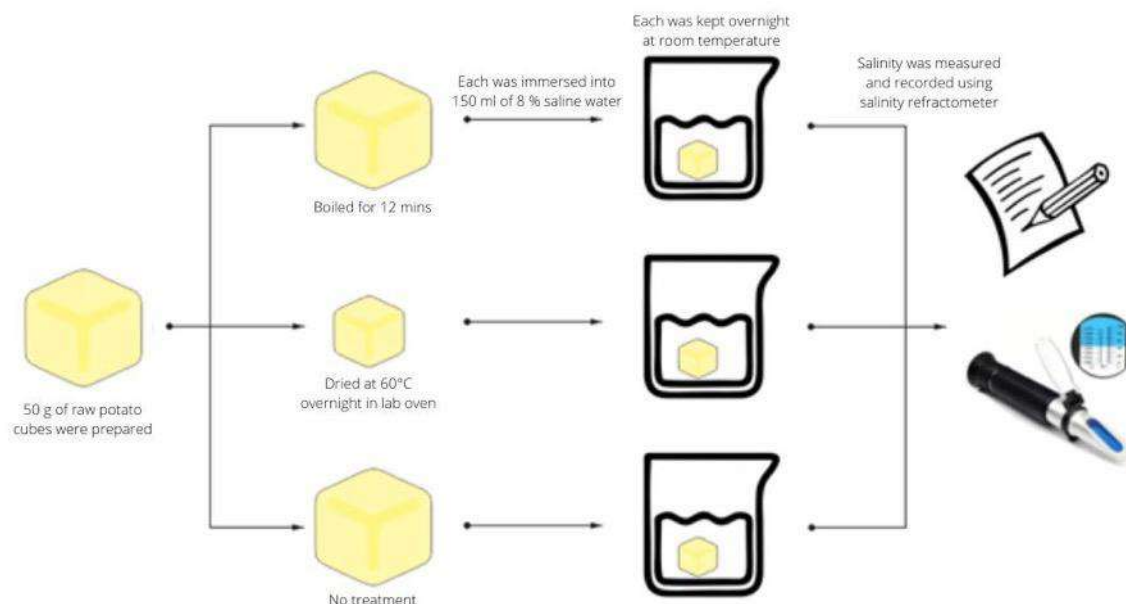

Figure 1: Methods used in the experimentation

In conclusion, the results of our study confirms the legitimacy of the "rumour" where putting potatoes would help reduce the salinity of dishes. However, the potatoes must be cooked first before being used to reduce the salinity of the dishes. Therefore, this might be a highly efficient method to save accidentally over salted soups.

Importance to Education

We believe that our study is able to inspire the other young curious minds that anybody is able to conduct their own research. No matter how simple the ideas are, the knowledge we could gain and learn from the effort will benefit us. Our hope is that more of our peers could also participate in ingraining the importance of implementation of scientific methods to find answers that eventually contributes to the world's bodies of knowledge.

References

- Goursot, A., Vasilyev, V., & Arbuznikov, A. (1997). Modeling of Adsorption Properties of Zeolites: Correlation with the Structure. *The Journal of Physical Chemistry B*, 101(33), 6420–6428. <https://doi.org/10.1021/jp971230b>
- Arafat, H. A., Franz, M., & Pinto, N. G. (1999). Effect of Salt on the Mechanism of Adsorption of Aromatics on Activated Carbon†. *Langmuir*, 15(18), 5997–6003. <https://doi.org/10.1021/la9813331>

APPENDIX A

LIST OF JUDGES

1. Ar. IDr. Ts. Ahmad Ridha Abdul Razak
2. Assoc. Prof. Dr. Akram M Zeki
3. Assoc. Prof. Dr. Azwan Bin Abdullah
4. Assoc. Prof. Dr. Mohamad Najmi Masri
5. Assoc. Prof. Dr. Mohammad Najib Jaffar
6. Assoc. Prof. Dr. Uswatun Hasanah Zaidan
7. Assoc. Prof. Dr. Yohan Kurniawan
8. Assoc. Prof. Ts. Dr. Fadhilah Mat Yamin
9. Assoc. Prof. Ts. Dr. Muhammad Mahadi Abdul Jamil
10. Assoc. Prof. Ts. Dr. Nik Zulkarnaen Bin Khidzir
11. Assoc. Prof. Ts. Dr. Tan Tse Guan
12. Chm. Ts. Dr. Abdul Hafidz Bin Yusoff
13. Cik Alia Nadhirah Bt Ahmad Kamal
14. Dr. Affizah Binti Mohamad Ghaffar
15. Dr. Azahah Binti Abu Hassan Sha'ari
16. Dr. Azrilawani Ahmad
17. Dr. Derweanna Bah Simpong
18. Dr. Fadli Fizari Bin Abu Hassan Asari
19. Dr. Hafzan Eva Mansor
20. Dr. Hasyiya Karimah Bt. Adli
21. Dr. Lee Boon Beng
22. Dr. Lewis Liew Teo Piaw
23. Dr. Mohd Ikhwan Bin Aziz
24. Dr. Mohd Zulkifli Muhammad
25. Dr. Muhamad Saufiyudin Bin Omar
26. Dr. Ong Tze Ching
27. Dr. Roslizawati Che Aziz
28. Dr. Sharulnizam Bin Ramli
29. Dr. Siti Aisyah Muhammad
30. Dr. Syamsuriana Binti Sidek
31. Dr. Umi Kalsom Masrom
32. Dr. Wan Ab Aziz Bin Wan Daud
33. Dr. Zulkfli Bin Md Yusoff
34. LAr. Dr. Ramly bin Hasan
35. Lt. Ts. Mohd Syafarim Bin Md Ishak
36. Mejar Bersekutu (PA) Mrs. Nuradilah Binti Abas
37. Mr. Adilreza Bin Shamsuri
38. Mr. Fairuladlan Bin Hamadun
39. Mr. Lingaswaran A/L Arjunan
40. Mr. Md Ariff Bin Ariffin

41. Mr. Mohd Aswawi Bin Isa
42. Mr. Muhammad Najibul Muthiie Bin Che Ya'acob
43. Mr. Nawil Bin Berahim
44. Mr. Razman Hafifi Bin Redzuan
45. Mr. Udom a/I Ewon
46. Mr. Zaki Bin Amiruddin
47. Mr. Zuhairy B. Zahari
48. Mrs. Affidah Mardziah Binti Mukhtar
49. Mrs. Farrah Atikah Binti Saari
50. Mrs. Hasanah Binti Safein @ Shafie
51. Mrs. Jamaliah Mohamad Sopi
52. Mrs. Melissa Khor Suan Chin
53. Mrs. Nur Rawaidah Rahmat
54. Mrs. Siti Hawa Binti Kadir
55. Ms. Izati Nabila Bt Marzuki
56. Ms. Siti Aishah Binti Attaullah
57. Ms. Ung Ean Na
58. Ms. Wan Suzanna Aafanii Adeeba Wan Ibrahim
59. Prof. Ts. Dr. Rosnah Shamsudin
60. Ts. Afzanizam Bin Alias
61. Ts. Dr. Darliana Binti Mohamad
62. Ts. Dr. Hasnita Binti Che Harun
63. Ts. Dr. Mardawani Mohamad
64. Ts. Dr. Maria Binti Mohammad
65. Ts. Dr. Noor Janatun Naim Binti Jemali
66. Ts. Dr. Nooraziah Binti Ahmad
67. Ts. Dr. Suganthi A/P Appalasamy
68. Ts. Dr. Teo Pao Ter
69. Ts. Dr. Zul-Atfi Ismail
70. Ts. Dr. Zulhisyam Bin Abdul Kari @ Abdullah
71. Ts. Mohamad Suhaimi Bin Shahrin
72. Ts. Mohd Sumazlin Bin Mahamed
73. Ts. Ng Perng Jeu
74. Ts. Wan Hussain Wan Ishak

e ISBN 978-967-2912-89-7



9 7 8 9 6 7 2 9 1 2 8 9 7

Research Management Innovation Centre
16300 Bachok, Kelantan Malaysia
Nombor telefon : 09-7797780
Email : rmic@umk.edu.my
Website : <http://rmic.umk.edu.my>